

# R&S® ZNC/ZND

## Vector Network Analyzers

### User Manual



1173.9557.02 – 29

This manual describes the following vector network analyzer types:

- R&S®ZNC3 (2 ports, 9 kHz to 3 GHz, N connectors), order no. 1311.6004K12
  - Hardware Options
    - R&S®ZNC-B10 "GPIB Interface", order no. 1316.1617.02
    - R&S®ZNC-B14 "Handler I/O", order no. 1316.2459.02
    - R&S®ZNC-B19 "Additional Removable Hard Disk, 32 bit IPS1", order no. 1323.9503.02
    - R&S®ZNC-B19 "Additional Removable Hard Disk, 64 bit IPS2", order no. 1323.9503.08
    - R&S®ZNC3-B22 "Extended Power Range for R&S®ZNC3", order no. 1316.1752.02
  - Software Options
    - R&S®ZNC-K2 "Time Domain Analysis", order no. 1316.1630.02
    - R&S®ZNC-K19 "1 mHz Frequency Resolution", order no. 1317.8596.02
- R&S®ZND (2 ports, 100 kHz to 4.5 GHz, unidirectional, N connectors), order no. 1328.5170.92
  - Hardware Options
    - R&S®ZND-B10 "GPIB Interface", order no. 1328.5358.02
    - R&S®ZND-B14 "Handler I/O", order no. 1316.2459.02
  - Software Options
    - R&S®ZND-K1 "Frequency range extension to 8.5 GHz for unidirectional instrument", order no. 1328.5306.02  
(not compatible with R&S®ZND-K5 and R&S®ZND-K8)
    - R&S®ZND-K2 "Time Domain (TDR)", order no. 1328.5393.02
    - R&S®ZND-K5 "Bidirectional measurements 100 kHz to 4.5 GHz", order no. 1328.5312.02  
(not compatible with R&S®ZND-K1 and R&S®ZND-K6)
    - R&S®ZND-K6 "Bidirectional measurements 100 kHz to 8.5 GHz", order no. 1328.5329.02  
(requires R&S®ZND-K1; not compatible with R&S®ZND-K5 and R&S®ZND-K8)
    - R&S®ZND-K8 "Frequency range extension to 8.5 GHz for bidirectional instrument", order no. 1328.5412.02  
(requires R&S®ZND-K5; not compatible with R&S®ZND-K1 and R&S®ZND-K6)
    - R&S®ZND-K7 "Extended Power Range", order no. 1328.5335.02
    - R&S®ZND-K19 "1 mHz Frequency Resolution", order no. 1326.8089.02

The software contained in this product makes use of several valuable open source software packages. For information, see the "Open Source Acknowledgment" on the user documentation CD-ROM (included in delivery).

Rohde & Schwarz would like to thank the open source community for their valuable contribution to embedded computing.

© 2016 Rohde & Schwarz GmbH & Co. KG  
Mühlhofstr. 15, 81671 München, Germany  
Phone: +49 89 41 29 - 0  
Fax: +49 89 41 29 12 164  
Email: [info@rohde-schwarz.com](mailto:info@rohde-schwarz.com)  
Internet: [www.rohde-schwarz.com](http://www.rohde-schwarz.com)

Subject to change – Data without tolerance limits is not binding.

R&S® is a registered trademark of Rohde & Schwarz GmbH & Co. KG.

Trade names are trademarks of the owners.

Throughout this manual, R&S® is abbreviated as R&S

# Basic Safety Instructions

## Always read through and comply with the following safety instructions!

All plants and locations of the Rohde & Schwarz group of companies make every effort to keep the safety standards of our products up to date and to offer our customers the highest possible degree of safety. Our products and the auxiliary equipment they require are designed, built and tested in accordance with the safety standards that apply in each case. Compliance with these standards is continuously monitored by our quality assurance system. The product described here has been designed, built and tested in accordance with the EC Certificate of Conformity and has left the manufacturer's plant in a condition fully complying with safety standards. To maintain this condition and to ensure safe operation, you must observe all instructions and warnings provided in this manual. If you have any questions regarding these safety instructions, the Rohde & Schwarz group of companies will be happy to answer them.



Furthermore, it is your responsibility to use the product in an appropriate manner. This product is designed for use solely in industrial and laboratory environments or, if expressly permitted, also in the field and must not be used in any way that may cause personal injury or property damage. You are responsible if the product is used for any purpose other than its designated purpose or in disregard of the manufacturer's instructions. The manufacturer shall assume no responsibility for such use of the product.

The product is used for its designated purpose if it is used in accordance with its product documentation and within its performance limits (see data sheet, documentation, the following safety instructions). Using the product requires technical skills and, in some cases, a basic knowledge of English. It is therefore essential that only skilled and specialized staff or thoroughly trained personnel with the required skills be allowed to use the product. If personal safety gear is required for using Rohde & Schwarz products, this will be indicated at the appropriate place in the product documentation. Keep the basic safety instructions and the product documentation in a safe place and pass them on to the subsequent users.











Observing the safety instructions will help prevent personal injury or damage of any kind caused by dangerous situations. Therefore, carefully read through and adhere to the following safety instructions before and when using the product. It is also absolutely essential to observe the additional safety instructions on personal safety, for example, that appear in relevant parts of the product documentation. In these safety instructions, the word "product" refers to all merchandise sold and distributed by the Rohde & Schwarz group of companies, including instruments, systems and all accessories. For product-specific information, see the data sheet and the product documentation.

## Safety labels on products

The following safety labels are used on products to warn against risks and dangers.

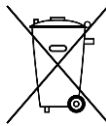
Symbol	Meaning	Symbol	Meaning
	Notice, general danger location Observe product documentation	○	ON/OFF Power
	Caution when handling heavy equipment	⏻	Standby indication
	Danger of electric shock	≡	Direct current (DC)

## Basic Safety Instructions

Symbol	Meaning	Symbol	Meaning
	Caution ! Hot surface		Alternating current (AC)
	Protective conductor terminal To identify any terminal which is intended for connection to an external conductor for protection against electric shock in case of a fault, or the terminal of a protective earth		Direct/alternating current (DC/AC)
	Earth (Ground)		Class II Equipment to identify equipment meeting the safety requirements specified for Class II equipment (device protected by double or reinforced insulation)
	Frame or chassis Ground terminal		EU labeling for batteries and accumulators For additional information, see section "Waste disposal/Environmental protection", item 1.
	Be careful when handling electrostatic sensitive devices		EU labeling for separate collection of electrical and electronic devices For additional information, see section "Waste disposal/Environmental protection", item 2.
	Warning! Laser radiation For additional information, see section "Operation", item 7.		

### Signal words and their meaning

The following signal words are used in the product documentation in order to warn the reader about risks and dangers.



Indicates a hazardous situation which, if not avoided, will result in death or serious injury.



Indicates a hazardous situation which, if not avoided, could result in death or serious injury.



Indicates a hazardous situation which, if not avoided, could result in minor or moderate injury.



Indicates information considered important, but not hazard-related, e.g. messages relating to property damage.

In the product documentation, the word ATTENTION is used synonymously.

These signal words are in accordance with the standard definition for civil applications in the European Economic Area. Definitions that deviate from the standard definition may also exist in other economic areas or military applications. It is therefore essential to make sure that the signal words described here are always used only in connection with the related product documentation and the related product. The use of signal words in connection with unrelated products or documentation can result in misinterpretation and in personal injury or material damage.

## Basic Safety Instructions

### Operating states and operating positions

*The product may be operated only under the operating conditions and in the positions specified by the manufacturer, without the product's ventilation being obstructed. If the manufacturer's specifications are not observed, this can result in electric shock, fire and/or serious personal injury or death. Applicable local or national safety regulations and rules for the prevention of accidents must be observed in all work performed.*

1. Unless otherwise specified, the following requirements apply to Rohde & Schwarz products: predefined operating position is always with the housing floor facing down, IP protection 2X, use only indoors, max. operating altitude 2000 m above sea level, max. transport altitude 4500 m above sea level. A tolerance of  $\pm 10\%$  shall apply to the nominal voltage and  $\pm 5\%$  to the nominal frequency, overvoltage category 2, pollution degree 2.
2. Do not place the product on surfaces, vehicles, cabinets or tables that for reasons of weight or stability are unsuitable for this purpose. Always follow the manufacturer's installation instructions when installing the product and fastening it to objects or structures (e.g. walls and shelves). An installation that is not carried out as described in the product documentation could result in personal injury or even death.
3. Do not place the product on heat-generating devices such as radiators or fan heaters. The ambient temperature must not exceed the maximum temperature specified in the product documentation or in the data sheet. Product overheating can cause electric shock, fire and/or serious personal injury or even death.

### Electrical safety

*If the information on electrical safety is not observed either at all or to the extent necessary, electric shock, fire and/or serious personal injury or death may occur.*

1. Prior to switching on the product, always ensure that the nominal voltage setting on the product matches the nominal voltage of the mains-supply network. If a different voltage is to be set, the power fuse of the product may have to be changed accordingly.
2. In the case of products of safety class I with movable power cord and connector, operation is permitted only on sockets with a protective conductor contact and protective conductor.
3. Intentionally breaking the protective conductor either in the feed line or in the product itself is not permitted. Doing so can result in the danger of an electric shock from the product. If extension cords or connector strips are implemented, they must be checked on a regular basis to ensure that they are safe to use.
4. If there is no power switch for disconnecting the product from the mains, or if the power switch is not suitable for this purpose, use the plug of the connecting cable to disconnect the product from the mains. In such cases, always ensure that the power plug is easily reachable and accessible at all times. For example, if the power plug is the disconnecting device, the length of the connecting cable must not exceed 3 m. Functional or electronic switches are not suitable for providing disconnection from the AC supply network. If products without power switches are integrated into racks or systems, the disconnecting device must be provided at the system level.
5. Never use the product if the power cable is damaged. Check the power cables on a regular basis to ensure that they are in proper operating condition. By taking appropriate safety measures and carefully laying the power cable, ensure that the cable cannot be damaged and that no one can be hurt by, for example, tripping over the cable or suffering an electric shock.

## Basic Safety Instructions

6. The product may be operated only from TN/TT supply networks fuse-protected with max. 16 A (higher fuse only after consulting with the Rohde & Schwarz group of companies).
7. Do not insert the plug into sockets that are dusty or dirty. Insert the plug firmly and all the way into the socket provided for this purpose. Otherwise, sparks that result in fire and/or injuries may occur.
8. Do not overload any sockets, extension cords or connector strips; doing so can cause fire or electric shocks.
9. For measurements in circuits with voltages  $V_{rms} > 30$  V, suitable measures (e.g. appropriate measuring equipment, fuse protection, current limiting, electrical separation, insulation) should be taken to avoid any hazards.
10. Ensure that the connections with information technology equipment, e.g. PCs or other industrial computers, comply with the IEC 60950-1 / EN 60950-1 or IEC 61010-1 / EN 61010-1 standards that apply in each case.
11. Unless expressly permitted, never remove the cover or any part of the housing while the product is in operation. Doing so will expose circuits and components and can lead to injuries, fire or damage to the product.
12. If a product is to be permanently installed, the connection between the protective conductor terminal on site and the product's protective conductor must be made first before any other connection is made. The product may be installed and connected only by a licensed electrician.
13. For permanently installed equipment without built-in fuses, circuit breakers or similar protective devices, the supply circuit must be fuse-protected in such a way that anyone who has access to the product, as well as the product itself, is adequately protected from injury or damage.
14. Use suitable overvoltage protection to ensure that no overvoltage (such as that caused by a bolt of lightning) can reach the product. Otherwise, the person operating the product will be exposed to the danger of an electric shock.
15. Any object that is not designed to be placed in the openings of the housing must not be used for this purpose. Doing so can cause short circuits inside the product and/or electric shocks, fire or injuries.
16. Unless specified otherwise, products are not liquid-proof (see also section "Operating states and operating positions", item 1). Therefore, the equipment must be protected against penetration by liquids. If the necessary precautions are not taken, the user may suffer electric shock or the product itself may be damaged, which can also lead to personal injury.
17. Never use the product under conditions in which condensation has formed or can form in or on the product, e.g. if the product has been moved from a cold to a warm environment. Penetration by water increases the risk of electric shock.
18. Prior to cleaning the product, disconnect it completely from the power supply (e.g. AC supply network or battery). Use a soft, non-linting cloth to clean the product. Never use chemical cleaning agents such as alcohol, acetone or diluents for cellulose lacquers.

## Operation

1. Operating the products requires special training and intense concentration. Make sure that persons who use the products are physically, mentally and emotionally fit enough to do so; otherwise, injuries or material damage may occur. It is the responsibility of the employer/operator to select suitable personnel for operating the products.

## Basic Safety Instructions

2. Before you move or transport the product, read and observe the section titled "Transport".
3. As with all industrially manufactured goods, the use of substances that induce an allergic reaction (allergens) such as nickel cannot be generally excluded. If you develop an allergic reaction (such as a skin rash, frequent sneezing, red eyes or respiratory difficulties) when using a Rohde & Schwarz product, consult a physician immediately to determine the cause and to prevent health problems or stress.
4. Before you start processing the product mechanically and/or thermally, or before you take it apart, be sure to read and pay special attention to the section titled "Waste disposal/Environmental protection", item 1.
5. Depending on the function, certain products such as RF radio equipment can produce an elevated level of electromagnetic radiation. Considering that unborn babies require increased protection, pregnant women must be protected by appropriate measures. Persons with pacemakers may also be exposed to risks from electromagnetic radiation. The employer/operator must evaluate workplaces where there is a special risk of exposure to radiation and, if necessary, take measures to avert the potential danger.
6. Should a fire occur, the product may release hazardous substances (gases, fluids, etc.) that can cause health problems. Therefore, suitable measures must be taken, e.g. protective masks and protective clothing must be worn.
7. Laser products are given warning labels that are standardized according to their laser class. Lasers can cause biological harm due to the properties of their radiation and due to their extremely concentrated electromagnetic power. If a laser product (e.g. a CD/DVD drive) is integrated into a Rohde & Schwarz product, absolutely no other settings or functions may be used as described in the product documentation. The objective is to prevent personal injury (e.g. due to laser beams).
8. EMC classes (in line with EN 55011/CISPR 11, and analogously with EN 55022/CISPR 22, EN 55032/CISPR 32)
  - Class A equipment:  
Equipment suitable for use in all environments except residential environments and environments that are directly connected to a low-voltage supply network that supplies residential buildings  
Note: Class A equipment is intended for use in an industrial environment. This equipment may cause radio disturbances in residential environments, due to possible conducted as well as radiated disturbances. In this case, the operator may be required to take appropriate measures to eliminate these disturbances.
  - Class B equipment:  
Equipment suitable for use in residential environments and environments that are directly connected to a low-voltage supply network that supplies residential buildings

### Repair and service

1. The product may be opened only by authorized, specially trained personnel. Before any work is performed on the product or before the product is opened, it must be disconnected from the AC supply network. Otherwise, personnel will be exposed to the risk of an electric shock.

## Basic Safety Instructions

- Adjustments, replacement of parts, maintenance and repair may be performed only by electrical experts authorized by Rohde & Schwarz. Only original parts may be used for replacing parts relevant to safety (e.g. power switches, power transformers, fuses). A safety test must always be performed after parts relevant to safety have been replaced (visual inspection, protective conductor test, insulation resistance measurement, leakage current measurement, functional test). This helps ensure the continued safety of the product.

### Batteries and rechargeable batteries/cells

*If the information regarding batteries and rechargeable batteries/cells is not observed either at all or to the extent necessary, product users may be exposed to the risk of explosions, fire and/or serious personal injury, and, in some cases, death. Batteries and rechargeable batteries with alkaline electrolytes (e.g. lithium cells) must be handled in accordance with the EN 62133 standard.*

- Cells must not be taken apart or crushed.
- Cells or batteries must not be exposed to heat or fire. Storage in direct sunlight must be avoided. Keep cells and batteries clean and dry. Clean soiled connectors using a dry, clean cloth.
- Cells or batteries must not be short-circuited. Cells or batteries must not be stored in a box or in a drawer where they can short-circuit each other, or where they can be short-circuited by other conductive materials. Cells and batteries must not be removed from their original packaging until they are ready to be used.
- Cells and batteries must not be exposed to any mechanical shocks that are stronger than permitted.
- If a cell develops a leak, the fluid must not be allowed to come into contact with the skin or eyes. If contact occurs, wash the affected area with plenty of water and seek medical aid.
- Improperly replacing or charging cells or batteries that contain alkaline electrolytes (e.g. lithium cells) can cause explosions. Replace cells or batteries only with the matching Rohde & Schwarz type (see parts list) in order to ensure the safety of the product.
- Cells and batteries must be recycled and kept separate from residual waste. Rechargeable batteries and normal batteries that contain lead, mercury or cadmium are hazardous waste. Observe the national regulations regarding waste disposal and recycling.

### Transport

- The product may be very heavy. Therefore, the product must be handled with care. In some cases, the user may require a suitable means of lifting or moving the product (e.g. with a lift-truck) to avoid back or other physical injuries.
- Handles on the products are designed exclusively to enable personnel to transport the product. It is therefore not permissible to use handles to fasten the product to or on transport equipment such as cranes, fork lifts, wagons, etc. The user is responsible for securely fastening the products to or on the means of transport or lifting. Observe the safety regulations of the manufacturer of the means of transport or lifting. Noncompliance can result in personal injury or material damage.
- If you use the product in a vehicle, it is the sole responsibility of the driver to drive the vehicle safely and properly. The manufacturer assumes no responsibility for accidents or collisions. Never use the product in a moving vehicle if doing so could distract the driver of the vehicle. Adequately secure the product in the vehicle to prevent injuries or other damage in the event of an accident.



## Instrucciones de seguridad elementales

### Waste disposal/Environmental protection

1. Specially marked equipment has a battery or accumulator that must not be disposed of with unsorted municipal waste, but must be collected separately. It may only be disposed of at a suitable collection point or via a Rohde & Schwarz customer service center.
2. Waste electrical and electronic equipment must not be disposed of with unsorted municipal waste, but must be collected separately.  
Rohde & Schwarz GmbH & Co. KG has developed a disposal concept and takes full responsibility for take-back obligations and disposal obligations for manufacturers within the EU. Contact your Rohde & Schwarz customer service center for environmentally responsible disposal of the product.
3. If products or their components are mechanically and/or thermally processed in a manner that goes beyond their intended use, hazardous substances (heavy-metal dust such as lead, beryllium, nickel) may be released. For this reason, the product may only be disassembled by specially trained personnel. Improper disassembly may be hazardous to your health. National waste disposal regulations must be observed.
4. If handling the product releases hazardous substances or fuels that must be disposed of in a special way, e.g. coolants or engine oils that must be replenished regularly, the safety instructions of the manufacturer of the hazardous substances or fuels and the applicable regional waste disposal regulations must be observed. Also observe the relevant safety instructions in the product documentation. The improper disposal of hazardous substances or fuels can cause health problems and lead to environmental damage.

For additional information about environmental protection, visit the Rohde & Schwarz website.

## Instrucciones de seguridad elementales

### ¡Es imprescindible leer y cumplir las siguientes instrucciones e informaciones de seguridad!

El principio del grupo de empresas Rohde & Schwarz consiste en tener nuestros productos siempre al día con los estándares de seguridad y de ofrecer a nuestros clientes el máximo grado de seguridad. Nuestros productos y todos los equipos adicionales son siempre fabricados y examinados según las normas de seguridad vigentes. Nuestro sistema de garantía de calidad controla constantemente que sean cumplidas estas normas. El presente producto ha sido fabricado y examinado según el certificado de conformidad de la UE y ha salido de nuestra planta en estado impecable según los estándares técnicos de seguridad. Para poder preservar este estado y garantizar un funcionamiento libre de peligros, el usuario deberá atenerse a todas las indicaciones, informaciones de seguridad y notas de alerta. El grupo de empresas Rohde & Schwarz está siempre a su disposición en caso de que tengan preguntas referentes a estas informaciones de seguridad.

Además queda en la responsabilidad del usuario utilizar el producto en la forma debida. Este producto está destinado exclusivamente al uso en la industria y el laboratorio o, si ha sido expresamente autorizado, para aplicaciones de campo y de ninguna manera deberá ser utilizado de modo que alguna persona/cosa pueda sufrir daño. El uso del producto fuera de sus fines definidos o sin tener en cuenta las instrucciones del fabricante queda en la responsabilidad del usuario. El fabricante no se hace en ninguna forma responsable de consecuencias a causa del mal uso del producto.















## Instrucciones de seguridad elementales

Se parte del uso correcto del producto para los fines definidos si el producto es utilizado conforme a las indicaciones de la correspondiente documentación del producto y dentro del margen de rendimiento definido (ver hoja de datos, documentación, informaciones de seguridad que siguen). El uso del producto hace necesarios conocimientos técnicos y ciertos conocimientos del idioma inglés. Por eso se debe tener en cuenta que el producto solo pueda ser operado por personal especializado o personas instruidas en profundidad con las capacidades correspondientes. Si fuera necesaria indumentaria de seguridad para el uso de productos de Rohde & Schwarz, encontraría la información debida en la documentación del producto en el capítulo correspondiente. Guarde bien las informaciones de seguridad elementales, así como la documentación del producto, y entréguelas a usuarios posteriores.



Tener en cuenta las informaciones de seguridad sirve para evitar en lo posible lesiones o daños por peligros de toda clase. Por eso es imprescindible leer detalladamente y comprender por completo las siguientes informaciones de seguridad antes de usar el producto, y respetarlas durante el uso del producto. Deberán tenerse en cuenta todas las demás informaciones de seguridad, como p. ej. las referentes a la protección de personas, que encontrarán en el capítulo correspondiente de la documentación del producto y que también son de obligado cumplimiento. En las presentes informaciones de seguridad se recogen todos los objetos que distribuye el grupo de empresas Rohde & Schwarz bajo la denominación de "producto", entre ellos también aparatos, instalaciones así como toda clase de accesorios. Los datos específicos del producto figuran en la hoja de datos y en la documentación del producto.

### Señalización de seguridad de los productos

Las siguientes señales de seguridad se utilizan en los productos para advertir sobre riesgos y peligros.

Símbolo	Significado	Símbolo	Significado
	Aviso: punto de peligro general Observar la documentación del producto		Tensión de alimentación de PUESTA EN MARCHA / PARADA
	Atención en el manejo de dispositivos de peso elevado		Indicación de estado de espera (standby)
	Peligro de choque eléctrico		Corriente continua (DC)
	Advertencia: superficie caliente		Corriente alterna (AC)
	Conexión a conductor de protección		Corriente continua / Corriente alterna (DC/AC)
	Conexión a tierra		El aparato está protegido en su totalidad por un aislamiento doble (reforzado)
	Conexión a masa		Distintivo de la UE para baterías y acumuladores Más información en la sección "Eliminación/protección del medio ambiente", punto 1.

## Instrucciones de seguridad elementales

Símbolo	Significado	Símbolo	Significado
	Aviso: Cuidado en el manejo de dispositivos sensibles a la electrostática (ESD)		Distintivo de la UE para la eliminación por separado de dispositivos eléctricos y electrónicos  Más información en la sección "Eliminación/protección del medio ambiente", punto 2.
	Advertencia: rayo láser  Más información en la sección "Funcionamiento", punto 7.		

### Palabras de señal y su significado

En la documentación del producto se utilizan las siguientes palabras de señal con el fin de advertir contra riesgos y peligros.



Indica una situación de peligro que, si no se evita, causa lesiones graves o incluso la muerte.



Indica una situación de peligro que, si no se evita, puede causar lesiones graves o incluso la muerte.



Indica una situación de peligro que, si no se evita, puede causar lesiones leves o moderadas.



Indica información que se considera importante, pero no en relación con situaciones de peligro; p. ej., avisos sobre posibles daños materiales.

En la documentación del producto se emplea de forma sinónima el término CUIDADO.

Las palabras de señal corresponden a la definición habitual para aplicaciones civiles en el área económica europea. Pueden existir definiciones diferentes a esta definición en otras áreas económicas o en aplicaciones militares. Por eso se deberá tener en cuenta que las palabras de señal aquí descritas sean utilizadas siempre solamente en combinación con la correspondiente documentación del producto y solamente en combinación con el producto correspondiente. La utilización de las palabras de señal en combinación con productos o documentaciones que no les correspondan puede llevar a interpretaciones equivocadas y tener por consecuencia daños en personas u objetos.

### Estados operativos y posiciones de funcionamiento

*El producto solamente debe ser utilizado según lo indicado por el fabricante respecto a los estados operativos y posiciones de funcionamiento sin que se obstruya la ventilación. Si no se siguen las indicaciones del fabricante, pueden producirse choques eléctricos, incendios y/o lesiones graves con posible consecuencia de muerte. En todos los trabajos deberán ser tenidas en cuenta las normas nacionales y locales de seguridad del trabajo y de prevención de accidentes.*

## Instrucciones de seguridad elementales

1. Si no se convino de otra manera, es para los productos Rohde & Schwarz válido lo que sigue: como posición de funcionamiento se define por principio la posición con el suelo de la caja para abajo, modo de protección IP 2X, uso solamente en estancias interiores, utilización hasta 2000 m sobre el nivel del mar, transporte hasta 4500 m sobre el nivel del mar. Se aplicará una tolerancia de  $\pm 10\%$  sobre el voltaje nominal y de  $\pm 5\%$  sobre la frecuencia nominal. Categoría de sobrecarga eléctrica 2, índice de suciedad 2.
2. No sitúe el producto encima de superficies, vehículos, estantes o mesas, que por sus características de peso o de estabilidad no sean aptos para él. Siga siempre las instrucciones de instalación del fabricante cuando instale y asegure el producto en objetos o estructuras (p. ej. paredes y estantes). Si se realiza la instalación de modo distinto al indicado en la documentación del producto, se pueden causar lesiones o, en determinadas circunstancias, incluso la muerte.
3. No ponga el producto sobre aparatos que generen calor (p. ej. radiadores o calefactores). La temperatura ambiente no debe superar la temperatura máxima especificada en la documentación del producto o en la hoja de datos. En caso de sobrecalentamiento del producto, pueden producirse choques eléctricos, incendios y/o lesiones graves con posible consecuencia de muerte.

### Seguridad eléctrica

*Si no se siguen (o se siguen de modo insuficiente) las indicaciones del fabricante en cuanto a seguridad eléctrica, pueden producirse choques eléctricos, incendios y/o lesiones graves con posible consecuencia de muerte.*

1. Antes de la puesta en marcha del producto se deberá comprobar siempre que la tensión preseleccionada en el producto coincida con la de la red de alimentación eléctrica. Si es necesario modificar el ajuste de tensión, también se deberán cambiar en caso dado los fusibles correspondientes del producto.
2. Los productos de la clase de protección I con alimentación móvil y enchufe individual solamente podrán enchufarse a tomas de corriente con contacto de seguridad y con conductor de protección conectado.
3. Queda prohibida la interrupción intencionada del conductor de protección, tanto en la toma de corriente como en el mismo producto. La interrupción puede tener como consecuencia el riesgo de que el producto sea fuente de choques eléctricos. Si se utilizan cables alargadores o regletas de enchufe, deberá garantizarse la realización de un examen regular de los mismos en cuanto a su estado técnico de seguridad.
4. Si el producto no está equipado con un interruptor para desconectarlo de la red, o bien si el interruptor existente no resulta apropiado para la desconexión de la red, el enchufe del cable de conexión se deberá considerar como un dispositivo de desconexión. El dispositivo de desconexión se debe poder alcanzar fácilmente y debe estar siempre bien accesible. Si, p. ej., el enchufe de conexión a la red es el dispositivo de desconexión, la longitud del cable de conexión no debe superar 3 m). Los interruptores selectores o electrónicos no son aptos para el corte de la red eléctrica. Si se integran productos sin interruptor en bastidores o instalaciones, se deberá colocar el interruptor en el nivel de la instalación.
5. No utilice nunca el producto si está dañado el cable de conexión a red. Compruebe regularmente el correcto estado de los cables de conexión a red. Asegúrese, mediante las medidas de protección y de instalación adecuadas, de que el cable de conexión a red no pueda ser dañado o de que nadie pueda ser dañado por él, p. ej. al tropezar o por un choque eléctrico.

## Instrucciones de seguridad elementales

6. Solamente está permitido el funcionamiento en redes de alimentación TN/TT aseguradas con fusibles de 16 A como máximo (utilización de fusibles de mayor amperaje solo previa consulta con el grupo de empresas Rohde & Schwarz).
7. Nunca conecte el enchufe en tomas de corriente sucias o llenas de polvo. Introduzca el enchufe por completo y fuertemente en la toma de corriente. La no observación de estas medidas puede provocar chispas, fuego y/o lesiones.
8. No sobrecargue las tomas de corriente, los cables alargadores o las regletas de enchufe ya que esto podría causar fuego o choques eléctricos.
9. En las mediciones en circuitos de corriente con una tensión  $U_{\text{eff}} > 30 \text{ V}$  se deberán tomar las medidas apropiadas para impedir cualquier peligro (p. ej. medios de medición adecuados, seguros, limitación de tensión, corte protector, aislamiento etc.).
10. Para la conexión con dispositivos informáticos como un PC o un ordenador industrial, debe comprobarse que éstos cumplan los estándares IEC60950-1/EN60950-1 o IEC61010-1/EN 61010-1 válidos en cada caso.
11. A menos que esté permitido expresamente, no retire nunca la tapa ni componentes de la carcasa mientras el producto esté en servicio. Esto pone a descubierto los cables y componentes eléctricos y puede causar lesiones, fuego o daños en el producto.
12. Si un producto se instala en un lugar fijo, se deberá primero conectar el conductor de protección fijo con el conductor de protección del producto antes de hacer cualquier otra conexión. La instalación y la conexión deberán ser efectuadas por un electricista especializado.
13. En el caso de dispositivos fijos que no estén provistos de fusibles, interruptor automático ni otros mecanismos de seguridad similares, el circuito de alimentación debe estar protegido de modo que todas las personas que puedan acceder al producto, así como el producto mismo, estén a salvo de posibles daños.
14. Todo producto debe estar protegido contra sobretensión (debida p. ej. a una caída del rayo) mediante los correspondientes sistemas de protección. Si no, el personal que lo utilice quedará expuesto al peligro de choque eléctrico.
15. No debe introducirse en los orificios de la caja del aparato ningún objeto que no esté destinado a ello. Esto puede producir cortocircuitos en el producto y/o puede causar choques eléctricos, fuego o lesiones.
16. Salvo indicación contraria, los productos no están impermeabilizados (ver también el capítulo "Estados operativos y posiciones de funcionamiento", punto 1). Por eso es necesario tomar las medidas necesarias para evitar la entrada de líquidos. En caso contrario, existe peligro de choque eléctrico para el usuario o de daños en el producto, que también pueden redundar en peligro para las personas.
17. No utilice el producto en condiciones en las que pueda producirse o ya se hayan producido condensaciones sobre el producto o en el interior de éste, como p. ej. al desplazarlo de un lugar frío a otro caliente. La entrada de agua aumenta el riesgo de choque eléctrico.
18. Antes de la limpieza, desconecte por completo el producto de la alimentación de tensión (p. ej. red de alimentación o batería). Realice la limpieza de los aparatos con un paño suave, que no se deshilache. No utilice bajo ningún concepto productos de limpieza químicos como alcohol, acetona o diluyentes para lacas nitrocelulósicas.

## Instrucciones de seguridad elementales

### Funcionamiento

1. El uso del producto requiere instrucciones especiales y una alta concentración durante el manejo. Debe asegurarse que las personas que manejen el producto estén a la altura de los requerimientos necesarios en cuanto a aptitudes físicas, psíquicas y emocionales, ya que de otra manera no se pueden excluir lesiones o daños de objetos. El empresario u operador es responsable de seleccionar el personal usuario apto para el manejo del producto.
2. Antes de desplazar o transportar el producto, lea y tenga en cuenta el capítulo "Transporte".
3. Como con todo producto de fabricación industrial no puede quedar excluida en general la posibilidad de que se produzcan alergias provocadas por algunos materiales empleados —los llamados alérgenos (p. ej. el níquel)—. Si durante el manejo de productos Rohde & Schwarz se producen reacciones alérgicas, como p. ej. irritaciones cutáneas, estornudos continuos, enrojecimiento de la conjuntiva o dificultades respiratorias, debe avisarse inmediatamente a un médico para investigar las causas y evitar cualquier molestia o daño a la salud.
4. Antes de la manipulación mecánica y/o térmica o el desmontaje del producto, debe tenerse en cuenta imprescindiblemente el capítulo "Eliminación/protección del medio ambiente", punto 1.
5. Ciertos productos, como p. ej. las instalaciones de radiocomunicación RF, pueden a causa de su función natural, emitir una radiación electromagnética aumentada. Deben tomarse todas las medidas necesarias para la protección de las mujeres embarazadas. También las personas con marcapasos pueden correr peligro a causa de la radiación electromagnética. El empresario/operador tiene la obligación de evaluar y señalizar las áreas de trabajo en las que exista un riesgo elevado de exposición a radiaciones.
6. Tenga en cuenta que en caso de incendio pueden desprenderse del producto sustancias tóxicas (gases, líquidos etc.) que pueden generar daños a la salud. Por eso, en caso de incendio deben usarse medidas adecuadas, como p. ej. máscaras antigás e indumentaria de protección.
7. Los productos con láser están provistos de indicaciones de advertencia normalizadas en función de la clase de láser del que se trate. Los rayos láser pueden provocar daños de tipo biológico a causa de las propiedades de su radiación y debido a su concentración extrema de potencia electromagnética. En caso de que un producto Rohde & Schwarz contenga un producto láser (p. ej. un lector de CD/DVD), no debe usarse ninguna otra configuración o función aparte de las descritas en la documentación del producto, a fin de evitar lesiones (p. ej. debidas a irradiación láser).
8. Clases de compatibilidad electromagnética (conforme a EN 55011 / CISPR 11; y en analogía con EN 55022 / CISPR 22, EN 55032 / CISPR 32)
  - Aparato de clase A:  
Aparato adecuado para su uso en todos los entornos excepto en los residenciales y en aquellos conectados directamente a una red de distribución de baja tensión que suministra corriente a edificios residenciales.  
Nota: Los aparatos de clase A están destinados al uso en entornos industriales. Estos aparatos pueden causar perturbaciones radioeléctricas en entornos residenciales debido a posibles perturbaciones guiadas o radiadas. En este caso, se le podrá solicitar al operador que tome las medidas adecuadas para eliminar estas perturbaciones.
  - Aparato de clase B:  
Aparato adecuado para su uso en entornos residenciales, así como en aquellos conectados directamente a una red de distribución de baja tensión que suministra corriente a edificios residenciales.

## Instrucciones de seguridad elementales

### Reparación y mantenimiento

1. El producto solamente debe ser abierto por personal especializado con autorización para ello. Antes de manipular el producto o abrirlo, es obligatorio desconectarlo de la tensión de alimentación, para evitar toda posibilidad de choque eléctrico.
2. El ajuste, el cambio de partes, el mantenimiento y la reparación deberán ser efectuadas solamente por electricistas autorizados por Rohde & Schwarz. Si se reponen partes con importancia para los aspectos de seguridad (p. ej. el enchufe, los transformadores o los fusibles), solamente podrán ser sustituidos por partes originales. Después de cada cambio de partes relevantes para la seguridad deberá realizarse un control de seguridad (control a primera vista, control del conductor de protección, medición de resistencia de aislamiento, medición de la corriente de fuga, control de funcionamiento). Con esto queda garantizada la seguridad del producto.

### Baterías y acumuladores o celdas

*Si no se siguen (o se siguen de modo insuficiente) las indicaciones en cuanto a las baterías y acumuladores o celdas, pueden producirse explosiones, incendios y/o lesiones graves con posible consecuencia de muerte. El manejo de baterías y acumuladores con electrolitos alcalinos (p. ej. celdas de litio) debe seguir el estándar EN 62133.*

1. No deben desmontarse, abrirse ni triturarse las celdas.
2. Las celdas o baterías no deben someterse a calor ni fuego. Debe evitarse el almacenamiento a la luz directa del sol. Las celdas y baterías deben mantenerse limpias y secas. Limpiar las conexiones sucias con un paño seco y limpio.
3. Las celdas o baterías no deben cortocircuitarse. Es peligroso almacenar las celdas o baterías en estuches o cajones en cuyo interior puedan cortocircuitarse por contacto recíproco o por contacto con otros materiales conductores. No deben extraerse las celdas o baterías de sus embalajes originales hasta el momento en que vayan a utilizarse.
4. Las celdas o baterías no deben someterse a impactos mecánicos fuertes indebidos.
5. En caso de falta de estanqueidad de una celda, el líquido vertido no debe entrar en contacto con la piel ni los ojos. Si se produce contacto, lavar con agua abundante la zona afectada y avisar a un médico.
6. En caso de cambio o recarga inadecuados, las celdas o baterías que contienen electrolitos alcalinos (p. ej. las celdas de litio) pueden explotar. Para garantizar la seguridad del producto, las celdas o baterías solo deben ser sustituidas por el tipo Rohde & Schwarz correspondiente (ver lista de recambios).
7. Las baterías y celdas deben reciclarse y no deben tirarse a la basura doméstica. Las baterías o acumuladores que contienen plomo, mercurio o cadmio deben tratarse como residuos especiales. Respete en esta relación las normas nacionales de eliminación y reciclaje.

### Transporte

1. El producto puede tener un peso elevado. Por eso es necesario desplazarlo o transportarlo con precaución y, si es necesario, usando un sistema de elevación adecuado (p. ej. una carretilla elevadora), a fin de evitar lesiones en la espalda u otros daños personales.

## Instrucciones de seguridad elementales

2. Las asas instaladas en los productos sirven solamente de ayuda para el transporte del producto por personas. Por eso no está permitido utilizar las asas para la sujeción en o sobre medios de transporte como p. ej. grúas, carretillas elevadoras de horquilla, carros etc. Es responsabilidad suya fijar los productos de manera segura a los medios de transporte o elevación. Para evitar daños personales o daños en el producto, siga las instrucciones de seguridad del fabricante del medio de transporte o elevación utilizado.
3. Si se utiliza el producto dentro de un vehículo, recae de manera exclusiva en el conductor la responsabilidad de conducir el vehículo de manera segura y adecuada. El fabricante no asumirá ninguna responsabilidad por accidentes o colisiones. No utilice nunca el producto dentro de un vehículo en movimiento si esto pudiera distraer al conductor. Asegure el producto dentro del vehículo debidamente para evitar, en caso de un accidente, lesiones u otra clase de daños.

### Eliminación/protección del medio ambiente

1. Los dispositivos marcados contienen una batería o un acumulador que no se debe desechar con los residuos domésticos sin clasificar, sino que debe ser recogido por separado. La eliminación se debe efectuar exclusivamente a través de un punto de recogida apropiado o del servicio de atención al cliente de Rohde & Schwarz.
2. Los dispositivos eléctricos usados no se deben desechar con los residuos domésticos sin clasificar, sino que deben ser recogidos por separado.  
Rohde & Schwarz GmbH & Co.KG ha elaborado un concepto de eliminación de residuos y asume plenamente los deberes de recogida y eliminación para los fabricantes dentro de la UE. Para desechar el producto de manera respetuosa con el medio ambiente, dirijase a su servicio de atención al cliente de Rohde & Schwarz.
3. Si se trabaja de manera mecánica y/o térmica cualquier producto o componente más allá del funcionamiento previsto, pueden liberarse sustancias peligrosas (polvos con contenido de metales pesados como p. ej. plomo, berilio o níquel). Por eso el producto solo debe ser desmontado por personal especializado con formación adecuada. Un desmontaje inadecuado puede ocasionar daños para la salud. Se deben tener en cuenta las directivas nacionales referentes a la eliminación de residuos.
4. En caso de que durante el trato del producto se formen sustancias peligrosas o combustibles que deban tratarse como residuos especiales (p. ej. refrigerantes o aceites de motor con intervalos de cambio definidos), deben tenerse en cuenta las indicaciones de seguridad del fabricante de dichas sustancias y las normas regionales de eliminación de residuos. Tenga en cuenta también en caso necesario las indicaciones de seguridad especiales contenidas en la documentación del producto. La eliminación incorrecta de sustancias peligrosas o combustibles puede causar daños a la salud o daños al medio ambiente.

Se puede encontrar más información sobre la protección del medio ambiente en la página web de Rohde & Schwarz.



# Quality management and environmental management

Certified Quality System  
**ISO 9001**

Certified Environmental System  
**ISO 14001**

## Sehr geehrter Kunde,

Sie haben sich für den Kauf eines Rohde&Schwarz Produktes entschieden. Sie erhalten damit ein nach modernsten Fertigungsmethoden hergestelltes Produkt. Es wurde nach den Regeln unserer Qualitäts- und Umweltmanagementsysteme entwickelt, gefertigt und geprüft. Rohde&Schwarz ist unter anderem nach den Managementsystemen ISO9001 und ISO 14001 zertifiziert.

## Der Umwelt verpflichtet

- Energie-effiziente, RoHS-konforme Produkte
- Kontinuierliche Weiterentwicklung nachhaltiger Umweltkonzepte
- ISO 14001-zertifiziertes Umweltmanagementsystem

## Dear customer,

You have decided to buy a Rohde&Schwarz product. This product has been manufactured using the most advanced methods. It was developed, manufactured and tested in compliance with our quality management and environmental management systems. Rohde&Schwarz has been certified, for example, according to the ISO9001 and ISO 14001 management systems.

## Environmental commitment

- Energy-efficient products
- Continuous improvement in environmental sustainability
- ISO 14001-certified environmental management system

## Cher client,

Vous avez choisi d'acheter un produit Rohde&Schwarz. Vous disposez donc d'un produit fabriqué d'après les méthodes les plus avancées. Le développement, la fabrication et les tests de ce produit ont été effectués selon nos systèmes de management de qualité et de management environnemental. La société Rohde&Schwarz a été homologuée, entre autres, conformément aux systèmes de management ISO 9001 et ISO 14001.

## Engagement écologique

- Produits à efficience énergétique
- Amélioration continue de la durabilité environnementale
- Système de management environnemental certifié selon ISO 14001



# Customer Support

## Technical support – where and when you need it

For quick, expert help with any Rohde & Schwarz equipment, contact one of our Customer Support Centers. A team of highly qualified engineers provides telephone support and will work with you to find a solution to your query on any aspect of the operation, programming or applications of Rohde & Schwarz equipment.

## Up-to-date information and upgrades

To keep your instrument up-to-date and to be informed about new application notes related to your instrument, please send an e-mail to the Customer Support Center stating your instrument and your wish. We will take care that you will get the right information.

### Europe, Africa, Middle East

Phone +49 89 4129 12345  
[customersupport@rohde-schwarz.com](mailto:customersupport@rohde-schwarz.com)

### North America

Phone 1-888-TEST-RSA (1-888-837-8772)  
[customer.support@rsa.rohde-schwarz.com](mailto:customer.support@rsa.rohde-schwarz.com)

### Latin America

Phone +1-410-910-7988  
[customersupport.la@rohde-schwarz.com](mailto:customersupport.la@rohde-schwarz.com)

### Asia/Pacific

Phone +65 65 13 04 88  
[customersupport.asia@rohde-schwarz.com](mailto:customersupport.asia@rohde-schwarz.com)

### China

Phone +86-800-810-8228 /  
+86-400-650-5896  
[customersupport.china@rohde-schwarz.com](mailto:customersupport.china@rohde-schwarz.com)



# Contents

<b>1</b>	<b>Documentation Map</b>	<b>9</b>
<b>2</b>	<b>Release Notes for Firmware V2.70</b>	<b>10</b>
<b>3</b>	<b>Concepts and Features</b>	<b>11</b>
<b>3.1</b>	<b>Basic Concepts</b>	<b>11</b>
3.1.1	Global (Persistent) Settings	11
3.1.2	Recall Sets	12
3.1.3	Traces, Channels and Diagrams	12
3.1.4	Sweep Control	14
3.1.5	Data Flow	18
<b>3.2</b>	<b>Screen Elements</b>	<b>20</b>
3.2.1	Control Elements of the Screen	20
3.2.2	Display Elements in the Diagram	25
3.2.3	Dialogs	36
3.2.4	Display Formats and Diagram Types	39
<b>3.3</b>	<b>Measurement Results</b>	<b>48</b>
3.3.1	S-Parameters	48
3.3.2	Impedance Parameters	49
3.3.3	Admittance Parameters	52
3.3.4	Wave Quantities and Ratios	54
3.3.5	Unbalance-Balance Conversion	57
3.3.6	Reference Impedances	60
3.3.7	Stability Factors	61
3.3.8	Delay, Aperture, Electrical Length	62
<b>3.4</b>	<b>Operations on Traces</b>	<b>63</b>
3.4.1	Limit Check	63
3.4.2	Trace Files	68
<b>3.5</b>	<b>Calibration</b>	<b>73</b>
3.5.1	Calibration Types	74
3.5.2	Calibration Standards and Calibration Kits	85
3.5.3	Calibration Pool	91
3.5.4	Calibration Labels	91

3.5.5	Automatic Calibration.....	91
3.5.6	Scalar Power Calibration.....	97
3.5.7	Parallel Calibration of Multiple Channels.....	102
<b>3.6</b>	<b>Offset Parameters and Embedding.....</b>	<b>103</b>
3.6.1	Offset Parameters.....	103
<b>3.7</b>	<b>Optional Extensions and Accessories.....</b>	<b>109</b>
3.7.1	Frequency Range Extension to 8.5 GHz for unidirectional R&S ZND.....	109
3.7.2	Bidirectional measurements 100 kHz to 4.5 GHz for R&S ZND.....	109
3.7.3	Bidirectional measurements 100 kHz to 8.5 GHz for R&S ZND.....	109
3.7.4	Frequency Range Extension to 8.5 GHz for bidirectional R&S ZND.....	110
3.7.5	Time Domain Analysis.....	110
3.7.6	Frequency Resolution 1 mHz.....	116
3.7.7	GPIB Interface.....	116
3.7.8	Handler I/O.....	116
3.7.9	Additional Removable HD (R&S ZNC only).....	116
3.7.10	Extended Power Range.....	117
3.7.11	External Power Meters.....	117
<b>4</b>	<b>GUI Reference.....</b>	<b>120</b>
<b>4.1</b>	<b>File Settings.....</b>	<b>120</b>
4.1.1	File > Recall Sets.....	120
4.1.2	File > Favorites.....	122
4.1.3	File > Print.....	123
4.1.4	File > Trace Data.....	125
4.1.5	File > More.....	125
<b>4.2</b>	<b>Trace Settings.....</b>	<b>126</b>
4.2.1	Meas Settings.....	126
4.2.2	Format Settings.....	150
4.2.3	Scale Settings.....	157
4.2.4	Trace Config Settings.....	162
4.2.5	Lines Settings.....	194
4.2.6	Marker Settings.....	210
<b>4.3</b>	<b>Stimulus Settings.....</b>	<b>228</b>
4.3.1	Stimulus > Stimulus.....	228

4.3.2	Stimulus > Power.....	230
4.3.3	Stimulus > Time Domain X-Axis.....	231
<b>4.4</b>	<b>Channel Settings.....</b>	<b>233</b>
4.4.1	Power Bandwidth Average Settings.....	233
4.4.2	Sweep Settings.....	236
4.4.3	Calibration.....	252
4.4.4	Channel Config.....	296
4.4.5	Trigger.....	304
4.4.6	Offset Embed.....	309
<b>4.5</b>	<b>Display Settings.....</b>	<b>319</b>
4.5.1	Display > Diagram.....	319
4.5.2	Display > Split.....	323
4.5.3	Display > Config.....	325
4.5.4	Define User Color Scheme (Dialog).....	328
4.5.5	Display > View Bar.....	330
4.5.6	Display > Touchscreen.....	331
<b>4.6</b>	<b>System Settings.....</b>	<b>332</b>
4.6.1	System > Setup > Setup.....	332
4.6.2	System Configuration (Dialog).....	333
4.6.3	Info Dialog.....	342
4.6.4	Service Function (Dialog).....	344
4.6.5	System > Setup > Freq. Ref.....	345
4.6.6	System > Setup > Remote Settings.....	346
4.6.7	Remote LXI (Dialog).....	348
4.6.8	System > Setup > External Devices.....	350
4.6.9	External Power Meters (Dialog).....	351
4.6.10	External Power Meter Config (Dialog).....	354
4.6.11	System > Print.....	355
4.6.12	Additional System Functions.....	355
<b>4.7</b>	<b>Applic Menu.....</b>	<b>355</b>
4.7.1	Applic > External Tools.....	356
<b>4.8</b>	<b>Help Menu.....</b>	<b>357</b>
<b>4.9</b>	<b>Control Menu.....</b>	<b>357</b>

<b>5 Remote Control.....</b>	<b>359</b>
<b>5.1 Introduction to Remote Control.....</b>	<b>359</b>
5.1.1 Starting a Remote Control Session.....	360
5.1.2 GPIB Explorer.....	360
5.1.3 Switchover to Remote Control.....	362
5.1.4 Combining Manual and Remote Control.....	364
<b>5.2 Messages.....</b>	<b>365</b>
5.2.1 Device Messages (Commands and Device Responses).....	365
5.2.2 SCPI Command Structure and Syntax.....	365
5.2.3 SCPI Parameters.....	369
<b>5.3 Basic Remote Control Concepts.....</b>	<b>371</b>
5.3.1 Traces, Channels, and Diagram Areas.....	371
5.3.2 Active Traces in Remote Control.....	372
5.3.3 Initiating Measurements, Speed Considerations.....	373
5.3.4 Addressing Traces and Channels.....	374
<b>5.4 Command Processing.....</b>	<b>375</b>
5.4.1 Input Unit.....	376
5.4.2 Command Recognition.....	376
5.4.3 Data Base and Instrument Hardware.....	376
5.4.4 Status Reporting System.....	377
5.4.5 Output Unit.....	377
5.4.6 Command Sequence and Command Synchronization.....	377
<b>5.5 Status Reporting System.....</b>	<b>379</b>
5.5.1 Overview of Status Registers.....	380
5.5.2 Structure of an SCPI Status Register.....	380
5.5.3 Contents of the Status Registers.....	382
5.5.4 Application of the Status Reporting System.....	389
5.5.5 Reset Values of the Status Reporting System.....	392
<b>5.6 LXI Configuration.....</b>	<b>392</b>
5.6.1 LXI Classes and LXI Functionality.....	392
5.6.2 LXI Browser Interface.....	393
5.6.3 LAN Configuration.....	394
<b>6 Command Reference.....</b>	<b>398</b>

<b>6.1</b>	<b>Special Terms and Notation.....</b>	<b>398</b>
6.1.1	Upper/Lower Case.....	399
6.1.2	Special Characters.....	399
6.1.3	Parameters.....	399
6.1.4	Numeric Suffixes.....	399
<b>6.2</b>	<b>Common Commands.....</b>	<b>400</b>
<b>6.3</b>	<b>SCPI Command Reference.....</b>	<b>401</b>
6.3.1	ABORt Commands.....	402
6.3.2	CALCulate Commands.....	402
6.3.3	CONFigure Commands.....	491
6.3.4	CONTrol Commands.....	499
6.3.5	DIAGnostic Commands.....	508
6.3.6	DISPlay Commands.....	509
6.3.7	FORMat Commands.....	534
6.3.8	HCOPY Commands.....	536
6.3.9	INITiate Commands.....	540
6.3.10	INSTrument Commands.....	543
6.3.11	MEMory.....	544
6.3.12	MMEMory Commands.....	546
6.3.13	OUTPut Commands.....	575
6.3.14	PROGram Commands.....	577
6.3.15	[SENSe:] Commands.....	581
6.3.16	SOURce Commands.....	678
6.3.17	STATus Commands.....	706
6.3.18	SYSTem Commands.....	710
6.3.19	TRACe Commands.....	734
6.3.20	TRIGger Commands.....	738
<b>6.4</b>	<b>R&amp;S ZVR/ZVAB Compatible Commands.....</b>	<b>744</b>
<b>7</b>	<b>Programming Examples.....</b>	<b>767</b>
<b>7.1</b>	<b>Basic Tasks.....</b>	<b>767</b>
7.1.1	Typical Stages of a Remote Control Program.....	767
7.1.2	Channel, Trace and Diagram Handling.....	770
<b>7.2</b>	<b>Condensed Programming Examples.....</b>	<b>776</b>

7.2.1	Path Independent RC Programs.....	776
7.2.2	Trace and Diagram Handling.....	777
7.2.3	Using Markers.....	786
7.2.4	Data Handling.....	788
7.2.5	Calibration.....	792
<b>8</b>	<b>Error Messages and Troubleshooting.....</b>	<b>798</b>
<b>8.1</b>	<b>Errors during Firmware Operation.....</b>	<b>798</b>
8.1.1	Asynchronous Errors.....	799
8.1.2	Errors during Measurement.....	799
8.1.3	Obtaining Technical Support.....	800
<b>8.2</b>	<b>Errors during Firmware Installation/Update.....</b>	<b>801</b>
<b>9</b>	<b>Annexes.....</b>	<b>803</b>
<b>9.1</b>	<b>Interfaces and Connectors.....</b>	<b>803</b>
9.1.1	Rear Panel Connectors.....	803
9.1.2	LAN Interface.....	805
9.1.3	GPIB Interface.....	805
9.1.4	Universal Interface.....	808
<b>9.2</b>	<b>Maintenance.....</b>	<b>816</b>
9.2.1	Storing and Packing the Instrument.....	816
9.2.2	Replacing Fuses.....	816
<b>9.3</b>	<b>Showroom Mode.....</b>	<b>817</b>
<b>9.4</b>	<b>ENA Emulation Commands.....</b>	<b>817</b>
	<b>Glossary: Frequently Used Terms.....</b>	<b>822</b>
	<b>List of Commands.....</b>	<b>828</b>
	<b>Index.....</b>	<b>842</b>



# 1 Documentation Map

The R&S ZNC/ZND documentation is delivered as a printed Getting Started guide and a documentation CD-ROM providing the complete user documentation. In addition, a help system is embedded in the instrument.

## Getting Started Guide

The Getting Started guide describes everything that is needed to put the instrument into operation and helps you to get familiar with the R&S ZNC/ZND. It gives an introduction to the instrument's operating concept and provides simple measurement examples. A printed Getting Started guide is delivered with each R&S ZNC/ZND.

## User Manual

The User Manual complements the Getting Started guide, providing a detailed description of the instrument's capabilities, examples and reference information for manual and remote control. The User Manual is available on the documentation CD-ROM; the most recent version is available for download on the R&S ZNC/ZND product pages on the R&S internet.

## Help System

The help system is embedded in the instrument, offering quick, context-sensitive reference to the information needed for operation and programming. It comprises the complete information of the Getting Started guide and the User Manual.

You can use the help also if you control the instrument from an external monitor. Furthermore you can transfer the help to your PC and use it as a standalone help.

## Documentation CD-ROM

The CD-ROM contains the complete user documentation for the R&S ZNC/ZND:

- the help system
- the Getting Started guide in printable form
- the User Manual in printable form
- brochures and data sheets in printable form
- the Service Manual in printable form
- links to various useful sites in the R&S Internet

## 2 Release Notes for Firmware V2.70

Version V2.70 of the R&S ZNC/ZND firmware provides the following changes:

### Product improvements

- Protection against data loss in case of improper shutdown (power loss, accidental hard power off etc.)
- "Automatic Harmonic Grid" functionality for "Time Domain Analysis" option R&S ZNC-K2 / R&S ZND-K2  
(see [Chapter 4.2.4.8, "Low Pass Settings \(Dialog\)"](#), on page 177)

### Bug fixes

- For generator levels *below* the possible range the message "Generator Level out of range. *Reduce* output power" was displayed



### Downgrade to a FW version < 2.40

In order to downgrade the FW from a version  $\geq 2.40$  to a version  $< 2.40$ , it is required to uninstall the "R&S ZNBC Compass Webserver" using the Windows 7 "Programs and Features" control panel before proceeding with the installation.

---

### Software version

- ▶ To check your R&S ZNC/ZND firmware version, press "Help > About...".

## 3 Concepts and Features

The following chapter provides an overview of the analyzer's capabilities and their use. This includes a description of the basic concepts that the analyzer uses to organize, process and display measurement data, of the screen contents, possible measured quantities, calibration methods and typical test setups.

For a systematic explanation of all softtools, functions and parameters refer to [Chapter 4, "GUI Reference"](#), on page 120.

### 3.1 Basic Concepts

The analyzer provides a variety of functions to perform a particular measurement and to customize and optimize the evaluation of results. To ensure that the instrument resources are easily accessible and that user-defined configurations can be conveniently implemented, stored and reused, the instrument uses a hierarchy of structures:

- Global resources can be used for all measurements, irrespective of the current measurement session or recall set.
- A recall set comprises a set of diagrams together with the underlying system, channel, trace and display settings. It can be saved to a recall set file.
- The diagrams show traces which are assigned to channels. See [Chapter 3.1.3, "Traces, Channels and Diagrams"](#), on page 12.

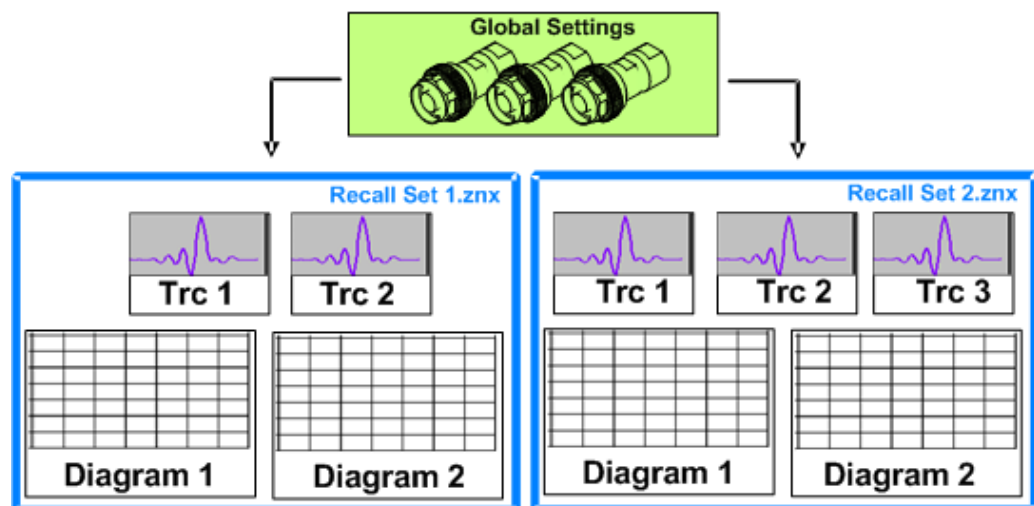

#### 3.1.1 Global (Persistent) Settings

The analyzer manages global settings that apply to all measurements, irrespective of the current measurement setup. The following list contains examples of global settings:

- Calibration kits
- Connector types

- Cal pool data including system error correction and power correction data
- Directories for trace data, limit lines, calibration data etc.
- Color schemes and printer settings
- System configurations, to be accessed via "SYSTEM > SETUP"
- External power meter configurations

Global settings are not part of a recall set nor are they affected by a "Preset" of the analyzer. Many of them can be "Reset" in the "System Config" dialog.

Some settings are session-specific, i.e. they are initialized to default when a new measurement session is started ("session settings").

### 3.1.2 Recall Sets

A recall set comprises a set of diagrams together with the underlying system, channel, trace and display settings. The R&S ZNC/ZND can handle multiple recall sets in parallel, each of them displayed in an independent tab.



A recall set can be saved to a recall set file (\*.znx) and reopened at a later point in time or at another instrument. Use the "Recalls Sets" tab of the "File" softtool (SYSTEM > FILE) to organize recall sets.



A recall set only contains setup instructions, i.e. information on how to measure, how to process the measurement results, and how to display the processed results. It does **not** contain any trace or result data.

### 3.1.3 Traces, Channels and Diagrams

The analyzer arranges, displays or stores the measured data in traces which are assigned to channels and displayed in diagrams. To understand the functions of the instrument and quickly find the appropriate settings, it is important to understand the exact meaning of the three terms.

- A trace is a set of data points that can be displayed together in a diagram. The trace settings specify the mathematical operations used in order to obtain traces from the measured or stored data and to display them.
- A channel contains hardware-related settings which specify how the network analyzer collects data.
- A diagram is a rectangular portion of the screen which is used to display traces. Diagrams belonging to the same recall set are arranged in a common window. The settings for diagrams are described in [Chapter 3.2.2, "Display Elements in the Diagram"](#), on page 25.

A diagram can contain a practically unlimited number of traces, assigned to different channels. diagrams and channels are completely independent from each other.

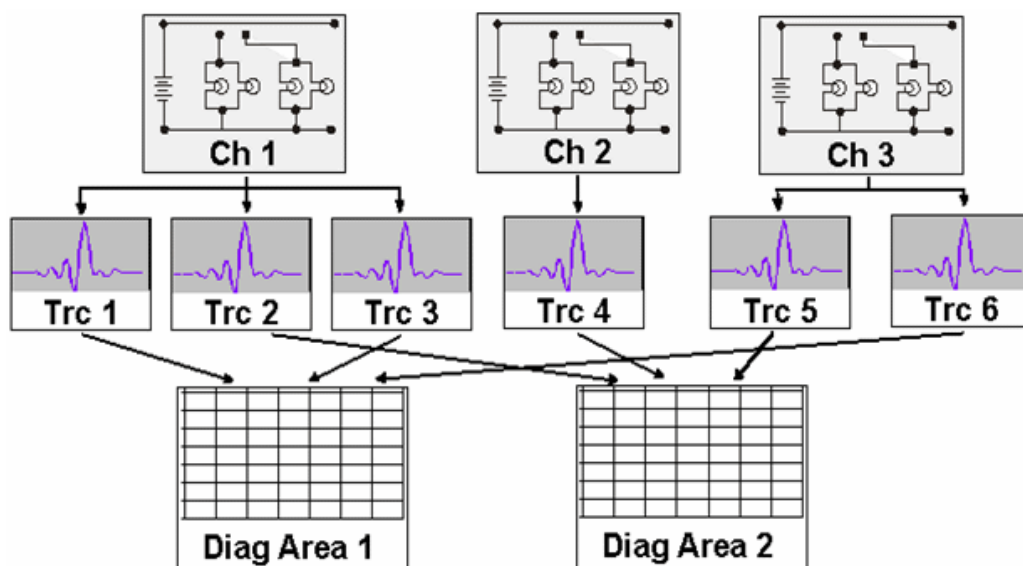

### 3.1.3.1 Trace Settings

The trace settings specify the mathematical operations used in order to obtain traces from the measured or stored data. They can be divided into several main groups:

- Selection of the measured quantity (S-parameters, wave quantities, ratios, impedances,...)
- Conversion into the appropriate display format and selection of the diagram type
- Scaling of the diagram and selection of the traces associated to the same channel
- Readout and search of particular values on the trace by means of markers
- Limit check

The softtools opened from the (virtual) keys in the TRACE (hard key) panel provide all trace settings. They complement the definitions accessible via the CHANNEL (hard key) panel. Each trace is assigned to a channel. The channel settings apply to all traces of the channel.



If a trace is selected in order to apply the trace settings, it becomes the active trace. In manual control there is always exactly one active trace, irrespective of the number of channels and traces defined. The active channel contains the active trace. In remote control, each channel contains an active trace.

See also [Chapter 5.3, "Basic Remote Control Concepts"](#), on page 371.

### 3.1.3.2 Channel Settings

A channel contains hardware-related settings which specify how the network analyzer collects data. The channel settings can be divided into three main groups:

- Description of the test setup ("Power" of the internal source, IF filter "Bandwidth", "Port Configuration")
- Control of the measurement process ("Sweep", "Trigger", "Average")

- Correction data ("Calibration", "Offset")

The softtools opened from the (virtual) keys in the CHANNEL ("Hard Key") panel provide all channel settings.

### 3.1.3.3 Active and Inactive Traces and Channels

A window can display several diagrams simultaneously, each with a variable number of traces. One of these traces is active at each time. The **active trace** is highlighted in the trace list on top of the active diagram (Trc3 in the figure below):



When a trace is selected in the diagram area, it becomes the **active trace**. Alternatively, you can select the active trace in the "TRACE > TRACE CONFIG > Traces" soft-tool tab. If a previously inactive area is selected as the active area, the trace that was active last time when the area was active will again become the active trace.

The **active channel** is the channel which belongs to the active trace. The channels of all traces in a diagram are listed at the bottom of the diagram, together with the "Stimulus" values and the display colors of all traces. The active channel is highlighted (Ch1 in the example below).

Ch1	Start 100 kHz	Pwr -10 dBm	Bw 10 kHz	Stop 3 GHz
Ch2	Start 100 kHz	Pwr -10 dBm	Bw 10 kHz	Stop 3 GHz
Ch3	Freq 1 GHz	Pwr -10 dBm	Bw 10 kHz	Stop 1 s
Ch4	Start 100 kHz	Pwr -10 dBm	Bw 10 kHz	Stop 3 GHz
Trc4	Start -1 ns	Time Domain		Stop 4 ns

Channels with no traces are not indicated in the diagrams but can be accessed via the "Channel Manager" dialog.

### 3.1.4 Sweep Control

A sweep is a series of consecutive measurements taken over a specified sequence of stimulus values. It represents the basic measurement cycle of the analyzer.

The analyzer can perform sweeps at constant power but variable frequency (frequency sweeps), sweeps at constant frequency but variable power (power sweeps), and sweeps at constant power and frequency that are repeated in time (Time/CW Mode sweeps). The sweeps are further specified by the number of measurement points and the total measurement time.

By default sweeps are repeated continuously. Alternatively, a measurement may also consist of a single sweep or of a specified number of sweeps.



After changing the channel settings or selecting another measured quantity, the analyzer needs some time to initialize the new sweep. This preparation period increases with the number of points and the number of partial measurements involved. It is visualized by a "Preparing Sweep" symbol in the status bar:



All analyzer settings can still be changed during sweep initialization. If necessary, the analyzer terminates the current initialization and starts a new preparation period. During the first sweep after a change of the channel settings, the asterisk symbol in the status bar remains yellow:



The asterisk turns grey after the first sweep has been completed.

### 3.1.4.1 Partial Measurements and Driving Mode

Depending on the measurement task and the measured quantities, the measurement at each sweep point can consist of one or several "partial measurements" with definite hardware settings.

- If a single S-parameter is measured (e.g. the reflection coefficient  $S_{11}$ ), the analyzer can operate at fixed hardware settings. In particular, a fixed source port and receive port is used. Each sweep point requires a single partial measurement. See also [Chapter 3.3.1, "S-Parameters"](#), on page 48.
- For a complete two-port S-parameter measurement (e.g.  $S_{11}$ ,  $S_{21}$ ,  $S_{12}$ ,  $S_{22}$ ) the analyzer needs to interchange the roles of the source and receive ports. Each sweep point requires two partial measurements.

To enhance the accuracy, it is possible to insert a delay time before each partial measurement.



In order to use port 2 of a R&S ZND as driving port, you need one of the "bidirectional measurements" options R&S ZND-K5 (for a R&S ZND without the "extended frequency range" option R&S ZND-K1) or R&S ZND-K6 (for a R&S ZND with R&S ZND-K1).

In the default configuration, the R&S ZNC/ZND performs a partial measurement at all sweep points (partial sweep) before the hardware settings are changed and the next partial measurement is carried out in an additional sweep ("Alternated" driving mode). It is possible though to reverse the order of partial measurements and sweeps ("Chopped" mode; see "CHANNEL > CHANNEL CONFIG > Mode > Driving Mode").

#### Advantages of alternated and chopped driving mode

If the settling time between adjacent frequency points is smaller than the settling time between the partial measurements (which is generally true), then the "Alternated" measurement is faster than a normal sweep so that smaller sweep times can be set. On the other hand, an "Alternated" measurement provides a result only during the last partial sweep.



Use the "Alternated" mode to increase the accuracy of measurements on DUTs with long level settling times (e.g. quartzes, SAW filters). To measure DUTs with short settling times and obtain a trace from the beginning of the sweep, use "Chopped" mode. In "Auto" mode, the analyzer will optimize the display update: Fast sweeps are performed in "Alternated" mode, slower sweeps in "Chopped" mode.

As an alternative to activating the "Alternate" mode, it is possible to insert a "Meas. Delay" before each partial measurement and thus improve the accuracy. The delay slows down the measurement.

### Relation to trigger settings

In triggered measurements, "Alternated" has no effect if the triggered measurement sequence is identical to a single sweep point. The following table shows how the analyzer performs a sweep comprising  $m$  sweep points, assuming that each of them requires  $n$  partial measurements.

Triggered Meas. Sequence	Alternate On	Alternate Off
Sweep	Trigger event starts $n$ partial sweeps over all sweep points.	Trigger event starts $m$ complete measurements at consecutive sweep points.
Sweep Segment	Trigger event starts $n$ partial sweeps over the next segment.	Trigger event starts complete measurements at all consecutive sweep points in the segment.
Point	All partial measurements of each sweep point are carried out one after another.	All partial measurements of each sweep point are carried out one after another.
Partial Measurement	Each partial measurement is carried out for all sweep points.	All partial measurements of each sweep point are carried out one after another.

### 3.1.4.2 R&S ZND: Unidirectional vs. Bidirectional Operation

In order to use port 2 of a R&S ZND as driving port, you need one of the "bidirectional measurements" options R&S ZND-K5 (for a R&S ZND without the "extended frequency range" option R&S ZND-K1) or R&S ZND-K6 (for a R&S ZND with R&S ZND-K1).

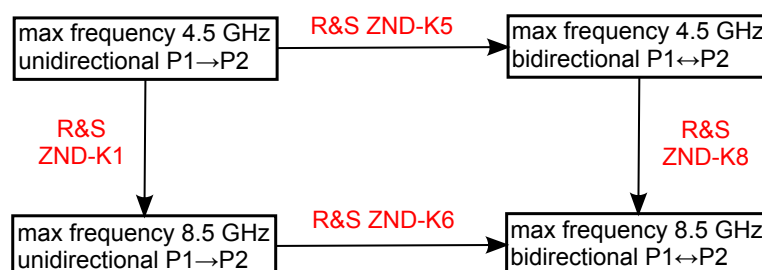

With unidirectional operation the following restrictions apply:

- S12, S22 and wave quantities of the reverse direction (port 2 as source) are not available



- Other (derived) results that require driving both ports, such as Y- and Z-parameters or stability parameters, are not available
- Balanced mode is not available
- Calibrations that require driving both ports are not available (see [Chapter 3.5.1, "Calibration Types"](#), on page 74)
- Cal kit characterizations cannot be performed
- Only automatic spur avoidance is possible (see ["Image Suppr."](#) on page 301)

### 3.1.4.3 Stimulus and Sweep Types

The function of the "START", "STOP", "CENTER" and "SPAN" keys depends on the sweep type.

**Table 3-1: Function of STIMULUS keys**

Sweep type	START [unit]	STOP [unit]	CENTER [unit]	SPAN [unit]
Lin. Frequency Log. Frequency Segmented Frequency	Start Frequency [Hz]	Stop Frequency [Hz]	Center Frequency [Hz]	Frequency Span [Hz]
Power	Start Power [dBm]	Stop Power [dBm]	CW Frequency [Hz]	CW Frequency [Hz]
CW Mode	CW Frequency [Hz]	CW Frequency [Hz]	CW Frequency [Hz]	CW Frequency [Hz]
Time	CW Frequency [Hz]	Stop Time [s]	CW Frequency [Hz]	CW Frequency [Hz]

The ranges of numerical values must be compatible with the instrument model. The conditions for the stimulus range depend on the sweep type:

- **Lin. Frequency/Log. Frequency/Segmented Frequency**  
The supported frequency range is listed in [Table 6-9](#).  
The stop frequency must be greater than the start frequency; the span must be  $\geq 1$  Hz. If a stop frequency smaller than the current start frequency is set, then the start frequency is adjusted and vice versa. A sweep must contain at least two different sweep points.
- **Power**  
Start and stop power are both entered in absolute units (dBm). Start and stop power must be different; the stop power must be larger than the start power. If a stop power smaller than the start power is set, then the start power is adjusted automatically and vice versa.  
The power corresponds to the actual source power at the test ports (channel base power  $P_b$ ). After a port power calibration, this source power is available at the calibrated reference plane.
- **CW Mode**  
The stimulus keys define the fixed stimulus frequency (CW Frequency) of the measurement. The other sweep parameters (e.g. the Number of Points) are set via "CHANNEL > SWEEP > Sweep Params".
- **Time**  
The "Stop" key defines the total sweep time (Stop Time). The remaining stimulus keys define the fixed stimulus frequency (CW Frequency) of the measurement. The

other sweep parameters (e.g. the Number of Points) are set via "CHANNEL > SWEEP > Sweep Params".

The sweep time is entered in seconds and must be positive.



The selected sweep range applies to all source and receive ports of the analyzer.

---

### 3.1.5 Data Flow

The analyzer processes the raw measurement data in a sequence of stages in order to obtain the displayed trace. The following diagram gives an overview.

The diagram consists of an upper and a lower part, corresponding to the data processing stages for the entire channel and for the individual traces. All stages in the diagram are configurable. Note that the channel data flow for S-parameters (and quantities derived from S-parameters such as impedances, admittances, stability factors etc.) differs from the channel data flow for wave quantities (and derived quantities such as ratios).

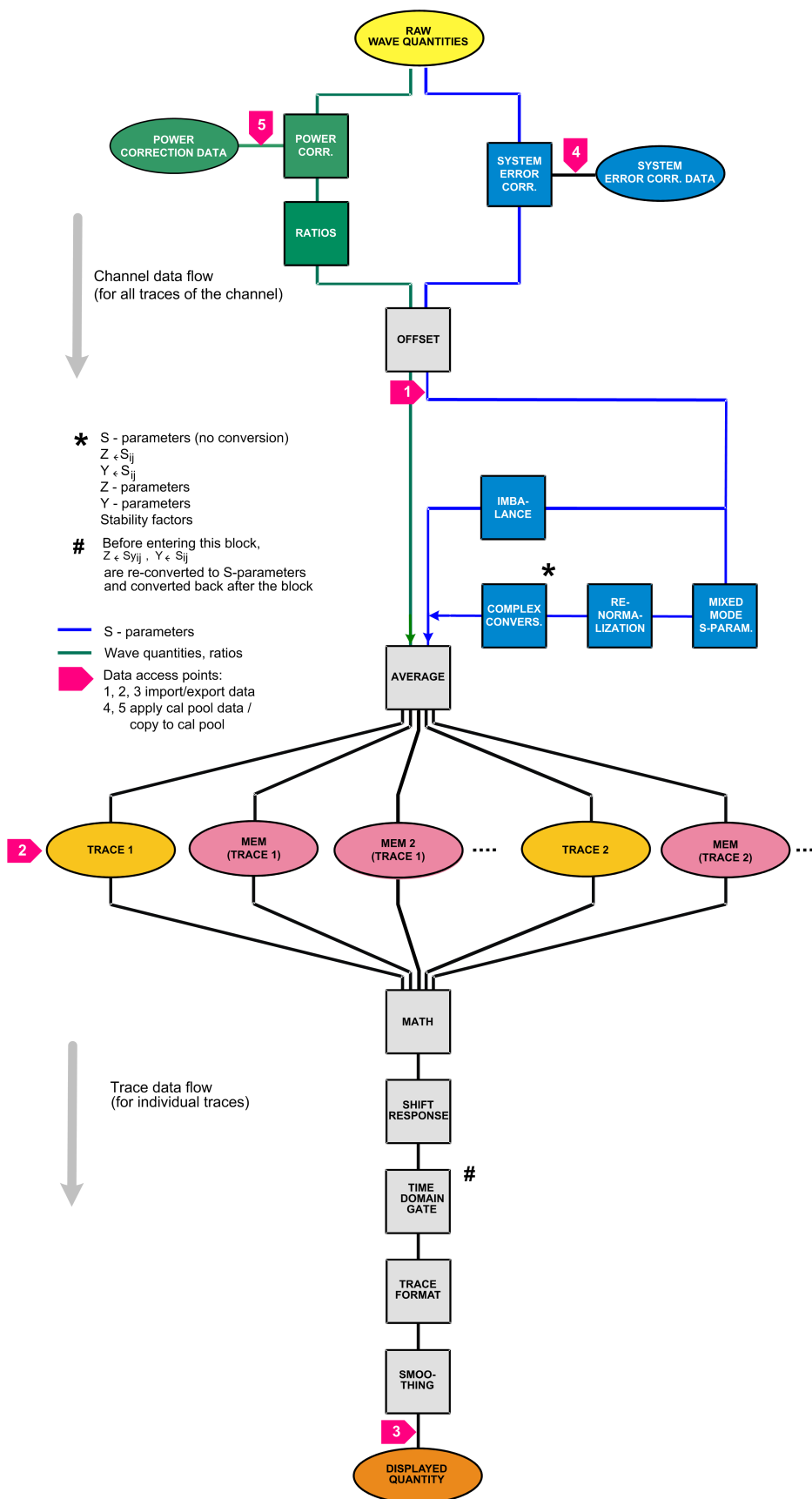

Figure 3-1: Data Flow

## 3.2 Screen Elements

This section describes the operating concept of the network analyzer, including the alternative navigation tools for touchscreen, mouse and hardkey operation, the trace settings, markers and diagrams. For a description of the different quantities measured by the analyzer refer to [Chapter 3.3, "Measurement Results"](#), on page 48.

### 3.2.1 Control Elements of the Screen

The main window of the analyzer provides all control elements for the measurements and contains the diagrams for the results. There are several alternative ways for accessing an instrument function:

- Using the icons in the toolbar above the diagram area (for frequent actions)
- Using the control elements of the softtool panel (recommended, provides all settings)
- Using the menus and submenus of the menu bar (alternative to the previous method)
- Using the hardkey panel (preselection of the most important softtool panels)

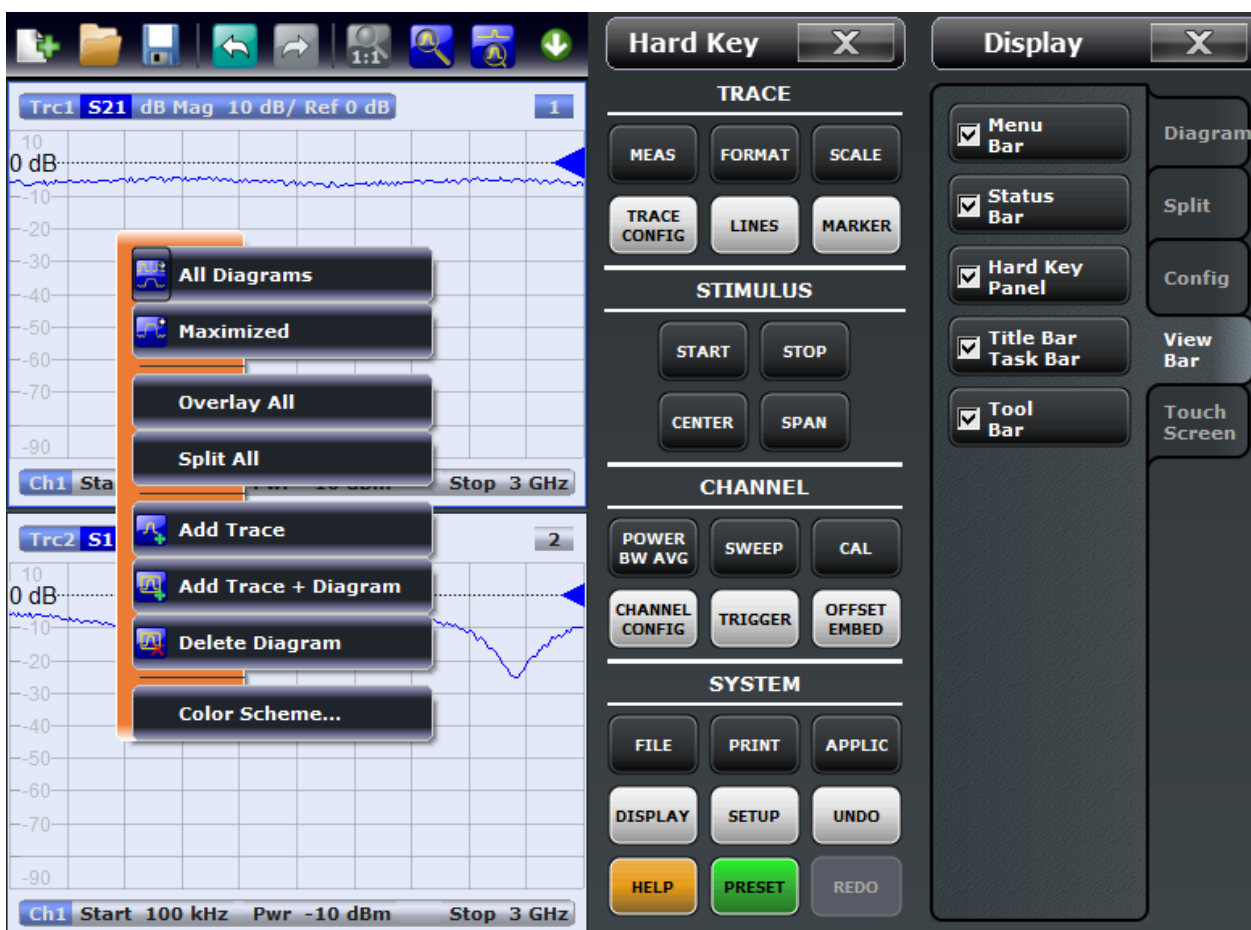

These methods are described in more detail in the following sections.

For further reference:

- Refer to [Chapter 3.2.2, "Display Elements in the Diagram"](#), on page 25 to obtain information about the results in the diagram.
- Refer to [Chapter 4.5, "Display Settings"](#), on page 319 and learn how to customize the screen.

### 3.2.1.1 Title Bar

The main application window of the vector network analyzer application provides a title bar, in analogy to every Windows® application. The title bar contains the name of the application and the standard minimize, maximize, and close buttons. The appearance depends on the "Control Panel" settings of the operating system.



You can display or hide the title bar using "SYSTEM > DISPLAY > View Bar" or "APPLIC > External Tools". The title bar is displayed together with the taskbar across the bottom of the screen which you can use to change between the VNA application and external tools.

### 3.2.1.2 Toolbar

The toolbar above the diagram area contains the most frequently used control elements of the user interface. All controls are also accessible from the R&S ZNC/ZND's softtool panels.



The toolbar is divided into five icon groups, separated by vertical lines.

- The leftmost group comprises recall set actions ("SYSTEM > FILE > Recall Sets"): add a new recall set ("New..."), open a recall set file ("Open Recall..."), save the active recall set to a file ("Save...")
- The second group comprises the undo and redo actions that are also accessible via the SYSTEM > UNDO and SYSTEM > REDO front panel keys.
- The icons in the middle group control the graphical zoom function ("TRACE > SCALE > Zoom"): "Zoom Reset", "Zoom Select", and "Overview Select".
- The icons in the fourth group allow to add a new trace and (possibly) a new diagram ("TRACE > TRACE CONFIG > Trace"), add a marker ("TRACE > Marker > Markers"), and delete a marker, trace, or diagram.
- The icon in the rightmost group allows to restart the sweep ("CHANNEL > SWEEP > Sweep Control > Restart Sweep")



You can hide the toolbar using "SYSTEM > DISPLAY > View Bar".

### 3.2.1.3 Softtool Panel

Softtool panels display groups of related settings. They can be opened via keys on the front panel or the on-screen "Hard Key" panel, or via menu bar and context menu items. Tapping a control element in the softtool panels activates a setting. You can also enter values and open dialogs with extended settings.

A softtool panel consists of a title (e.g. "Display") with a close/re-open icon and the control element area below. The title remains displayed when the softtool panel is closed, which allows you to re-open closed softtools at any time. Most softtool panels are subdivided into different tabs (e.g. "Diagram", "Split", "Config", "View Bar", "Touch Screen").



Softtool panels may contain different types of control elements:

- A button with a double arrow (e.g. "Color Scheme" in the example above) opens a list of alternative settings.
- A button with three dots (e.g. "User Define..." in the example above) opens a dialog which provides several related settings.
- A button with a checkmark (e.g. "Frequency Info" in the example above) enables or disables.
- A button with a light background (e.g. "Font Size" in the example above) is an input field for numbers or characters.
- A labeled button with no additional symbols directly initiates an action.

### 3.2.1.4 Menu Bar

All analyzer functions are arranged in drop-down menus. The menu bar is located across the bottom of the diagram:



As in any Windows® application, menus can be controlled with the touchscreen or a mouse. A short tap (left mouse click) expands a menu or submenu. If a menu command has no submenu assigned, a short tap (left mouse click) opens a dialog or directly activates the menu command. When a (sub)menu is selected, the R&S ZNC/ZND displays the corresponding softtool panel.

### Overview of menu functions

- The "File" menu provides standard Windows® functions that can be used to create, save, recall or print recall sets, to copy the current screen or to shut down the application.
- The "Trace" menu provides all trace settings, the limit check settings, and the marker functions including marker search.
- The "Channel" menu provides all channel settings and activates, modifies or stores different channels.
- The "Display" menu provides all display settings and the functions for activating, modifying and arranging different diagrams.
- The "Applications" menu gives access to applications and tools that extend the functionality of the analyzer firmware.
- The "System" menu provides functions that can be used to return to a defined instrument state, reverse operations, access service functions and define various system-related settings.
- The "Help" menu provides assistance with the network analyzer and its operation.



You can hide the menu bar using "SYSTEM > DISPLAY > View Bar".

### 3.2.1.5 Menu Structure

All menus show an analogous structure.



- A menu command with a right arrow expands a submenu with further related settings.  
**Example:** "Marker" expands a submenu with marker-related properties.
- A menu command with three dots appended calls up a dialog providing several related settings.  
**Example:** "Search Range" opens a dialog to define the search range for the marker search.
- A menu command with no arrow or dots initiates an immediate action.  
**Example:** "Max" sets the active marker to the maximum of the active trace.

### 3.2.1.6 Hardkey Panel

The hardkey panel (see "SYSTEM > DISPLAY > View Bar") shows the setup keys which you also find at the front panel of the R&S ZNC/ZND. Most keys open a particular tab of the softtool panel providing related control elements. For a short description refer to section "Instrument Tour" in the Help or in the Getting Started guide.

The hardkey panel corresponds to the TRACE, STIMULUS, CHANNEL, and SYSTEM keypads:



The hardkey panel is particularly useful if the analyzer is controlled from an external monitor or Remote Desktop. Alternatively the settings are accessible from the menu bar or from the context menu.

The hardkey panel is hidden by default to gain screen space for the diagrams. You can display it using "SYSTEM > DISPLAY > View Bar"



### 3.2.1.7 Status Bar

The status bar shows

- the active channel and drive port (P1, P2 ...)
- the statistics for the sweep average (if sweep average is on, otherwise "Avg None")
- the progress of the sweep  
The progress bar also shows when the R&S ZNC/ZND prepares a sweep with new channel settings  
(See [Chapter 3.1.4, "Sweep Control"](#), on page 14)
- the External Reference symbol (if an external reference clock is used for synchronization)  
(see ["Ext Frequency"](#) on page 346)
- the LXI status symbol (if enabled; see "SYSTEM > SETUP > Remote Settings")  
A green LXI status symbol indicates that a LAN connection has been established; a red symbol indicates that no LAN cable is connected.
- the current date and time



The progress bar slowly oscillates from left to right and back if the sweep is too fast to be monitored, e.g. because the number of sweep points is low. You can hide the status bar using "SYSTEM > DISPLAY > View Bar".

## 3.2.2 Display Elements in the Diagram

The central part of the screen is occupied by one or several diagrams.

A "diagram" is a rectangular portion of the screen used to display traces. Diagrams are independent of trace and channel settings. A diagram can contain a practically unlimited number of traces which may be assigned to different channels.

Most diagram settings are arranged in the "Display" softtool ("SYSTEM > DISPLAY"). To assign traces and channels to diagrams, use the control elements in the "TRACE > TRACE CONFIG > Traces" and "CHANNEL > CHANNEL CONFIG > Channels" soft-tool panels.

Diagrams may contain:

- A title (optional)
- The current number of the diagram
- Measurement results, in particular traces and marker values (optional)
- An indication of the basic channel and trace settings
- Context menus providing settings which are related to a particular display element
- Error messages



The examples in this section have been taken from Cartesian diagrams. All other diagram types provide the same display elements.

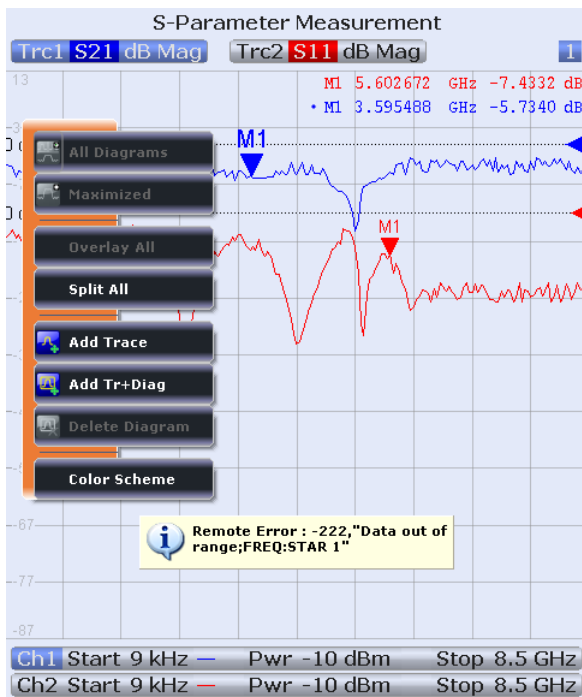

### 3.2.2.1 Title

An optional title across the top of the diagram may be used for a brief description of the diagram contents.

S-Parameter Measurement



Select "SYSTEM > DISPLAY > Diagram > Show Title" to display or hide the title.

### 3.2.2.2 Traces

A trace is a set of data points displayed together in the diagram. The individual data points are connected so that each trace forms a continuous line.

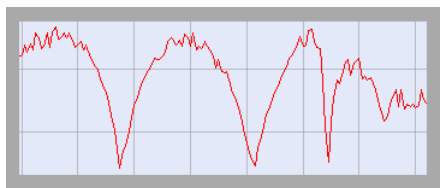

The trace can be complemented by the following display elements, plotted with the same color:

- Reference value (for all traces): The reference value is indicated with a triangle at the right edge of the diagram and a dashed, horizontal line. The value and position of the triangle can be changed in order to modify the diagram scale and shift the trace vertically.
- Measured quantity (for the active trace): The measured quantity is indicated in the trace list; see ["Trace List and Trace Settings"](#) on page 27.

A trace can be either a data trace, a memory trace, or a mathematical trace; see ["Trace Types"](#) on page 27.

### Trace Types

The analyzer uses traces to display the current measurement result in a diagram but is also capable of storing traces to the memory, recalling stored traces, and defining mathematical relations between different traces. There are three basic trace types:

- Data traces show the current measurement data and are continuously updated as the measurement goes on. Data traces are dynamic traces.
- Memory traces are generated by storing the data trace to the memory. They represent the state of the data trace at the moment when it was stored. Memory traces are static traces which can be stored to a file and recalled.
- Mathematical traces are calculated according to a mathematical relation between constants and the data or memory traces of the active recall set. A mathematical trace that is based on the active data trace is dynamic.

It is possible to generate an unlimited number of memory traces from a data trace and display them together. Markers and marker functions are available for all trace types.



The type of each trace in a diagram is indicated in the trace list: "MEM<no>" at the beginning of the trace name indicates a memory trace (with default naming), "Math" at the end of the trace label indicates a mathematical trace. You can also hide a trace ("Invisible") without deleting it.

Trc1	S21	dB Mag	10 dB / Ref 0 dB	Ch1	Math
Mem3[Trc1]	S21	dB Mag	10 dB / Ref 0 dB	Ch1	
Trc5	S21	dB Mag	10 dB / Ref 0 dB	Ch2	Invisible

### Trace List and Trace Settings

The main properties of all traces assigned to the diagram are displayed in the trace list in the upper part of the diagram.

Trc1	S21	dB Mag	10 dB / Ref 0 dB	Ch1	Math
Mem3[Trc1]	S21	dB Mag	10 dB / Ref 0 dB	Ch1	
Trc5	S21	dB Mag	10 dB / Ref 0 dB	Ch2	Invisible

Each line in the trace list describes a single trace. The active trace is highlighted ("Trc5" in the example above). The lines are divided into several sections with the following contents (from left to right):

- The **trace name** appears in the first section. The default names for new traces are Trc<n> with n automatically selected. A "Mem..." at the beginning of the trace name indicates a memory trace (default naming). To change the trace names, open the "Trace Manager" from any trace name segment's context menu or via TRACE > TRACE CONFIG > Traces.
- The **measured quantity** (e.g. an S-parameter or a ratio) appears on a colored background. The source port for wave quantities and ratios is indicated in brackets.
- The **format** section shows how the measured data is presented in the graphical display ("TRACE > FORMAT").
- The next sections show the value of the vertical or radial diagram divisions ("Scale Div.") and the reference value ("Ref").
- The **channel** section shows the channel that each trace is assigned to. It is omitted if the all traces in the diagram are assigned to the same channel.
- The **type** section indicates "Invisible" if a trace is hidden and "Math" if the trace is a mathematical trace. "GAT" indicates that a time gate is active for the trace. Use the "TRACE > TRACE CONFIG > Mem Math" functions to display and hide data and memory traces, and to define mathematical traces.



The respective section's context menu (except for the type section) provides access to the most common related tasks.

### Example:

The following context menu is assigned to the measured quantity section in the trace list:





A label "Cal Off" appears at the end of the trace line if the system error correction no longer applies to the trace.

### 3.2.2.3 Markers

Markers are tools for numerical readout of measured data and for selecting points on the trace. A marker is displayed with a symbol (e.g. a triangle, a crossbar or a line) on the trace, which may be a data trace or a memory trace. At the same time, the coordinates are displayed in a marker info field or in a table. Each marker can be defined as a normal marker (M), reference marker (R), or delta marker ( $\Delta$ M).



- A (normal) marker ("M1, M2 ...") determines the coordinates of a measurement point on the trace. Up to 10 different normal markers can be assigned to a trace.
- The reference marker ("R") defines the reference value for all delta markers.
- A delta marker ("ΔM1, ΔM2 ...") indicates the coordinates relative to the reference marker.

A special set of markers M1 to M4 is provided for bandfilter search mode.

The most common tasks to be performed with markers can be achieved using the "Marker" menu functions:

- Determine the coordinates of a measurement point on the trace. In polar diagrams where no x-axis is displayed, markers can be used to retrieve the stimulus value of specific points.
- Determine the difference between two trace points or the relative measurement result ("Delta Mode").
- Convert a complex measurement result into other formats.

Markers also play an important role in performing the following advanced tasks:

- Change the sweep range and the diagram scale ("Marker Function").
- Search for specific points on the trace ("Marker Search", "Target Search", "Bandfilter Search").

#### Activating and Moving Markers

To activate a marker, either select the marker symbol itself or the corresponding line in the marker info field.

To move the active marker on the trace use one of the following methods:

- Drag-and-drop the marker symbol to the desired position.

- Activate the "TRACE > MARKER > Markers" softtool and enter the related stimulus value numerically.
- Use the functions on the "TRACE > MARKER > Marker Search" softtool tab to move the marker to a specific position.



If the marker position is adjusted using the rollkey, the mouse or the cursor keys, it always remains within the sweep range. If set explicitly by entering a numeric value, the marker position can be outside the sweep range. In this case, the marker symbol is automatically positioned to the start or stop value of the sweep range, whichever is closer.

### Marker Info Field

The coordinates of all markers defined in a diagram can be displayed in the info field, which by default is located in the upper right corner.

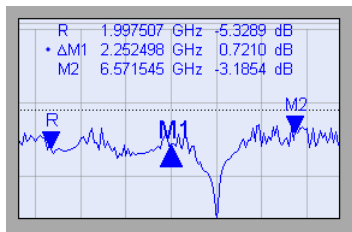

The info field contains the following information:

- "M1, M2, ..." denote the marker numbers. Markers are displayed with the same color as the associated trace.
- The marker coordinates are expressed in one of the marker formats selected via "TRACE > MARKER > Marker Properties > Marker Format". The formats of the markers assigned to a trace are independent of each other and of the trace format settings.
- The active marker has a dot placed in front of the marker line.
- "R" denotes the reference marker. A "Δ" sign placed in front of the marker line indicates that the marker is in delta mode.

### Customizing the marker info field

To change the position, appearance or contents of the marker info field use one of the following methods:

- The info field may be moved to several positions in the upper and lower part of the active diagram. Drag & drop it to the desired position.
- Open the context menu of the marker info field to access frequently used marker settings.

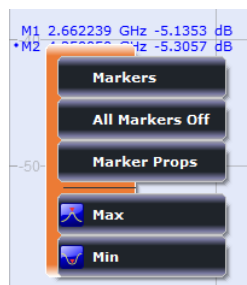

The settings correspond to the most common functions in the "TRACE > MARKER > Markers", "TRACE > MARKER > Marker Props", and "TRACE > MARKER > Marker Search" menus.

- To change the format of the active marker, select "TRACE > MARKER > Marker Props > Marker Format".
- To express the coordinates of the active marker relative to the reference marker, activate the delta mode "TRACE > MARKER > Markers > Delta Mode".



**Info Table**

If you wish to reserve the full diagram area for the traces, you can drag & drop the marker info field in to the info table.

M1	Trc1	5.100040	GHz	-15.2736	dB	Bandstop Trc1	Ref to Max	Track
M2	Trc1	4.568776	GHz	-4.7532	dB	Bandwidth	991.256235	MHz
M3	Trc1	5.560033	GHz	-4.7532	dB	Center	5.040094	GHz
M4	Trc1	5.040094	GHz	-11.1110	dB	Lower Edge	4.568776	GHz
						Upper Edge	5.560033	GHz
						Quality Factor	5.085	U
						Loss	15.2736	dB

The table is hidden by default. To display the table, select "DISPLAY > Config > Info Table: Show".

**Marker Format**

Marker values may be formatted according to the current trace format (configured in the TRACE > FORMAT softtool), according to a preselected default marker format of the related trace (TRACE > FORMAT > Default Marker Frmt), or formatted individually (TRACE > MARKER > Marker Props > Marker Format).

The available marker formats are defined for all measured quantities and trace formats (see Chapter 3.2.4.6, "Measured Quantities and Display Formats", on page 47). Essentially, a marker format is simply a conversion between points on a complex-valued trace (the raw measurement data) and the respective target format. This must be kept in mind when interpreting the results and physical units displayed.

The following table describes how a complex marker value  $z = x + jy$  is converted. It makes use of the polar representation  $z = x + jy = |z| e^{j\varphi(z)}$ , where

$$|z| = (x^2 + y^2)^{1/2} \text{ and } \varphi(z) = \arctan(y / x)$$

Table 3-2: Marker formats

Marker Format	Description	Formula
Default	<ul style="list-style-type: none"> <li>For an <b>individual marker's</b> this means the marker is formatted according to the "Default Marker Format" of the related trace!</li> <li>For a <b>trace's default marker format</b> this means the default format is (dynamically) adjusted according to the selected trace format</li> </ul>	–
Lin Mag	Magnitude of z, unconverted	$ z  = \sqrt{x^2 + y^2}$
dB Mag	Magnitude of z in dB	$ z  = \sqrt{x^2 + y^2}$ dB Mag(z) = $20 * \log z $ dB
Phase	Phase of z	$\varphi(z) = \arctan(y/x)$
Delay	Group delay, neg. derivative of the phase response <sup>*)</sup>	$-\frac{d\varphi(z)}{d\omega}$ , where $\omega$ denotes the stimulus frequency
Real	Real part of z	$\text{Re}(z) = x$
Imag	Imaginary part of z	$\text{Im}(z) = y$
SWR	(Voltage) Standing Wave Ratio	$\text{SWR} = (1 +  z ) / (1 -  z )$
dB Mag Phase	Magnitude of z in dB and phase in two lines	$20 * \log z $ dB $\arctan(\text{Im}(z) / \text{Re}(z))$
Lin Mag Phase	Magnitude of z (unconverted) and phase in two lines	$ z  \arctan(\text{Im}(z) / \text{Re}(z))$
Real Imag	Real and imaginary part of z in two lines	x y
R + j X	Unnormalized resistance, reactance, and L or C in three lines (Smith diagram)	R X L or C <sup>**)</sup>
G + j B	Unnormalized conductance, susceptance, and L or C in three lines (Inverted Smith diagram)	G B L or C <sup>**)</sup>
IMP Mag	Impedance Magnitude (combined complex impedance) <sup>**)</sup>	$ Z  = (R^2 + X^2)^{1/2}$
Index	Index of the current sweep point	–

<sup>\*)</sup> The delay aperture is defined in the TRACE > FORMAT softtool.

<sup>\*\*)</sup> An impedance Z is represented as  $Z = R + jX$ , the corresponding admittance as  $Y = 1/Z = G + jB$ . For  $X \geq 0$  we have an inductance  $L = X/\omega$ , for  $X < 0$  we have a capacitance  $C = 1/(\omega X)$ , where  $\omega$  denotes the stimulus frequency.

### Marker Coupling

The concept of marker coupling means that corresponding markers on different traces (i.e. markers with the same number or reference markers) are positioned to the same stimulus values but keep their independent format and type settings.



When a trace with markers is selected as the active trace and marker coupling is switched on, the following happens:

- The active trace and all associated markers are left unchanged. The active trace markers become the master markers of the recall set.
- Markers on the other traces which have no corresponding master marker are removed but remember their properties and can be re-activated after the coupling is released.
- The remaining markers on the other traces become slave markers and are moved to the position of the corresponding master markers. "Missing" slave markers are created so that each trace has the same number of markers placed at the same position.
- If the position of a master marker is outside the sweep range of the slave trace, the slave marker is displayed at the edge of the diagram. The marker info field indicates an invalid measurement result:

M1	5.732428 GHz	-5.0957 dB
M2	2.940895 GHz	-----
M3	4.750000 GHz	-6.7854 dB

While marker coupling is active, it is possible to:

- Move a master marker and thus change the position of all corresponding slave markers.
- Activate another trace in order to make the associated markers the new master markers.



Marker coupling makes sense only if the master and the slave traces use the same stimulus variable. Channels with a different stimulus variable (sweep type) are not coupled.

### Basic Marker Search Functions

The search functions are tools for searching measurement data according to specific criteria. A search consists of analyzing the measurement points of the current trace (or of a user-defined subrange termed the "Search Range") in order to find one of the following:

- Absolute or relative (local) maxima and minima (minimum/maximum search).
- Trace points with a specific response value (target search).
- Trace segments with a shape that is characteristic for bandpass or bandstop filters (bandfilter search); see "[Bandfilter Search](#)" on page 34.

When the search is activated, the active marker is moved to the (next) point that meets the search criteria. If the trace contains no markers, a marker M1 is created and used for the search. The search result is displayed in the marker info field. If no search result can be found, the marker remains at its original position.

Some search functions can be activated repeatedly in order to find all possible search results. Moreover the analyzer provides a "Tracking" mode where the search is repeated after each sweep.

### Multiple Peak Search

Multiple peak search allows to find multiple local minima/maxima at once. Markers 1 to 10 are assigned to the peaks detected from the start frequency towards the stop frequency. Multiple Peak Search uses its own search and tracking settings; search and tracking settings for standard marker search are ignored.

### Bandfilter Search

In a bandfilter search, the R&S ZNC/ZND locates trace segments with a bandpass or bandstop shape and determines characteristic filter parameters.

Bandpass and bandstop regions can be described with the same parameter set:

- A bandpass region contains a local maximum around which the magnitude of the trace falls off by more than a specified value.
- A bandstop region contains a local minimum around which the magnitude of the trace increases by more than a specified value.

The analyzer locates bandpass and bandstop regions and determines their position ("Center" frequency) and shape ("Bandwidth, lower and upper edge", quality factor. For a meaningful definition of the bandwidth factor, the trace format must be "dB Mag".

Bandstop Trc1	Ref to Max	Track
Bandwidth	653.8226535340 MHz	
Center	5.007709480401 GHz	
Lower Edge	4.691457457576 GHz	
Upper Edge	5.345280111110 GHz	
Quality Factor (3dB)	10.741 U	
Quality Factor (BW)	7.647 U	
Loss	15.2808 dB	

The info field contains the following search results:

- "Bandwidth" is the n-dB bandwidth of the bandpass/bandstop region, where n is a selectable bandwidth factor. The bandwidth is equal to the difference between the lower and the upper band edge frequency.
- "Center" is calculated as the geometric or arithmetic mean of the lower band edge frequency  $f_{LBE}$  and the upper band edge frequency  $f_{UBE}$ :  

$$f_{Center} = \sqrt{f_{LBE} * f_{UBE}} \quad (\text{geometric mean}) \text{ or}$$

$$f_{Center} = 1/2 (f_{LBE} + f_{UBE}) \quad (\text{arithmetic mean})$$

The arithmetic mean is always higher than the geometric mean. The values are close if the bandwidth is small compared to the geometric mean of the band edges.
- "Lower Edge" is the closest frequency below the maximum (or minimum), where the trace value is equal to the maximum (minimum) value minus (plus) n dB.
- "Upper Edge" is the closest frequency above the maximum (or minimum), where the trace value is equal to the maximum (minimum) value minus (plus) n dB.
- The "Quality Factor (3 dB)" is the ratio between the "Center" frequency and the 3-dB "Bandwidth"; it does not depend on the selected bandwidth factor.
- The "Quality Factor (BW)" is the ratio between the "Center" frequency and the "Bandwidth" displayed above. This result is available only if the selected bandwidth factor is different from 3 dB.
- "Loss" is the loss of the filter at its center frequency and is equal to the response value of marker no. 4. For an ideal bandpass filter the loss is zero (0 dB), for an ideal bandstop filter it is  $-\infty$  dB.

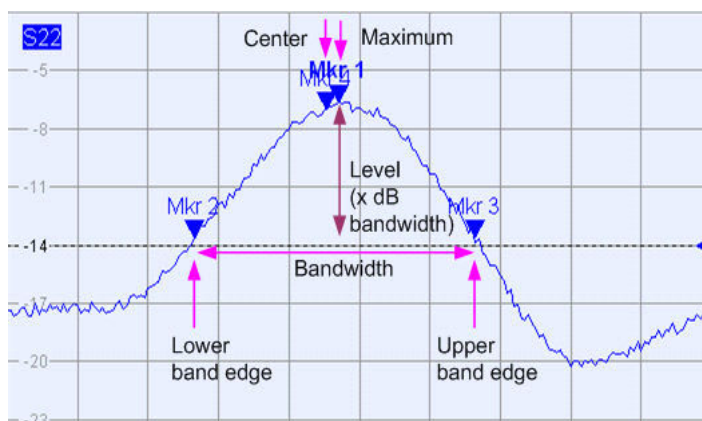

### 3.2.2.4 Channel List and Channel Settings

The main properties of all channels assigned to the traces in the diagram are displayed in the channel list below the diagram.

Ch1	Start	100 kHz	—	Pwr	-10 dBm	Bw	10 kHz	Stop	3 GHz
Ch2	Start	100 kHz	—	Pwr	-10 dBm	Bw	10 kHz	Stop	3 GHz
Ch3	Freq	1 GHz	—	Pwr	-10 dBm	Bw	10 kHz	Stop	1 s
Ch4	Start	100 kHz	—	Pwr	-10 dBm	Bw	10 kHz	Stop	3 GHz
Trc4	Start	-1 ns	—	Time Domain				Stop	4 ns

Each line in the channel list describes a single channel. The channel of the active trace is highlighted. The lines are divided into several sections with the following contents (from left to right):

- The "channel name" appears in the first section. The default names for new channels are Ch<n> with an automatically assigned number <n>. If a time domain transform is active, the R&S ZNC/ZND displays an additional line to indicate the stimulus range of the displayed time-domain trace. Open the "Channel Manager" from the name segment's context menu to change the channel name.
- **Start** indicates the lowest value of the sweep variable (e.g. the lowest frequency measured), corresponding to the left edge of a Cartesian diagram.
- The **color legend** shows the display color of all traces assigned to the channel. The colors are different, so the number of colors is equal to the numbers of traces assigned to the channel.
- The values behind the color legend show the **constant stimulus value**, which is either the power of the internal signal source (for frequency sweeps and time sweeps) or the CW frequency (for power sweeps), and the measurement bandwidth ("BW").
- **Stop** indicates the highest value of the sweep variable (e.g. the highest frequency measured), corresponding to the right edge of a Cartesian diagram.



Open a segment's context menu to access common related tasks.

**Example:**

The following context menu is assigned to the channel name section:

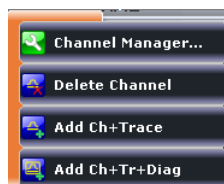

The settings in the context menus correspond to the most common functions in the "CHANNEL > CONFIG > Channels", "STIMULUS", "CHANNEL > SWEEP > Sweep Params" and "CHANNEL > POWER BW AVG" menus.

**3.2.2.5 Context Menus**

To provide access to the most common tasks and speed up the operation, the analyzer offers context menus (right-click menus) for the following display elements:

- Diagram
- Marker info field
- Trace list (separate context menus for trace name section, measured quantity section, format section, scale section, and channel section)
- Channel list (separate context menus for channel name section, sweep range section, additional parameter section)

To open a context menu associated with a display element, tap and hold the element for some seconds. Right-click the display element if you use a mouse.

**Example:**

The following context menu is assigned to the channel name section in the channel list:

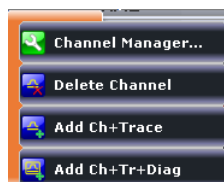

Except from some particular screen configurations, anything that can be done from the context menu can also be done from the menu bar, the front panel keys or softtool panels. Use whatever method is most convenient.

**3.2.3 Dialogs**

Dialogs provide groups of related settings and allow to make selections and enter data in an organized way. All softkeys with three dots behind their labeling (as in "Balanced Ports...") call up a dialog. The dialogs of the analyzer have an analogous structure and a number of common control elements.

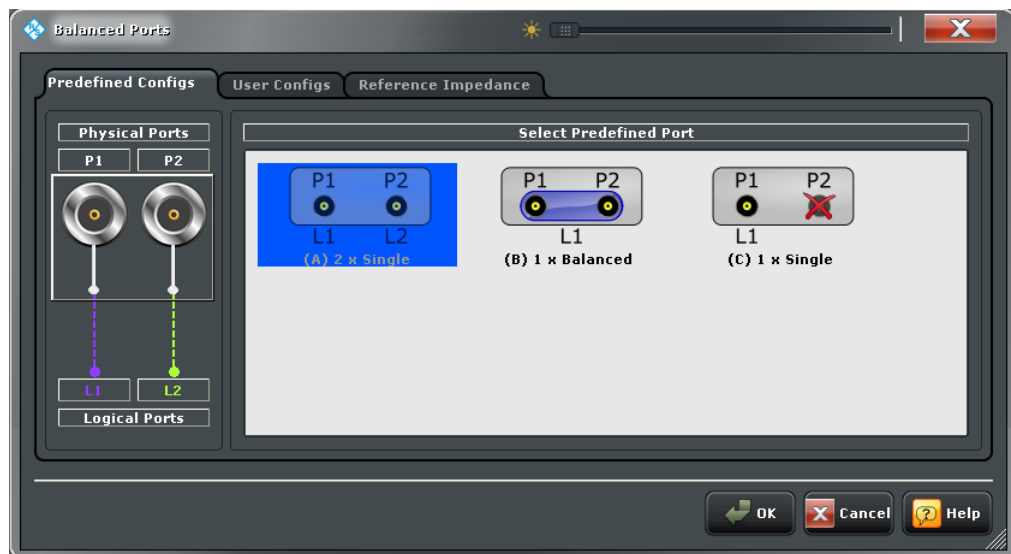

Dialogs are controlled in the usual way. For an introduction refer to section "Working with Dialogs" in the Help or in the Getting Started guide.

### 3.2.3.1 Immediate vs. Confirmed Settings

In some dialogs, the settings take effect immediately so that the effect on the measurement is observable while the dialog is still open. This is especially convenient when a numeric value is incremented or decremented, or when display elements are added or removed.

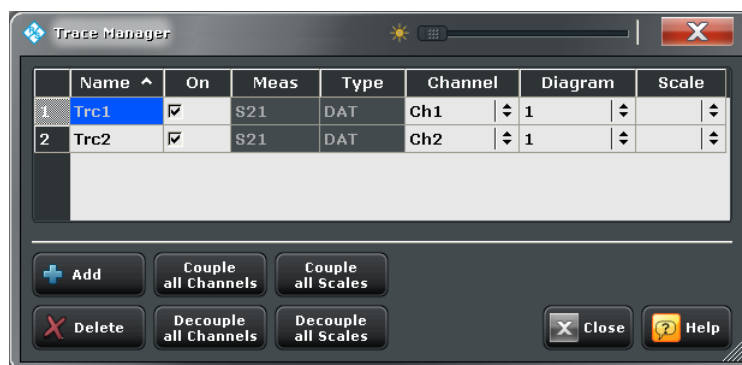

In most dialogs, however, it is possible to cancel an erroneous input before it takes effect. The settings in such dialogs must be confirmed explicitly.

The two types of dialogs are easy to distinguish:

- Dialogs with immediate settings provide a "Close" button but no "OK" button.  
Example: "Trace Manager" dialog
- Dialogs with confirmed settings provide both an "OK" button and a "Cancel" button.  
Example: "Balanced Ports" dialog



Immediate settings can be undone using the UNDO key or "System > Undo".

### 3.2.3.2 Common Dialogs

#### Open dialog

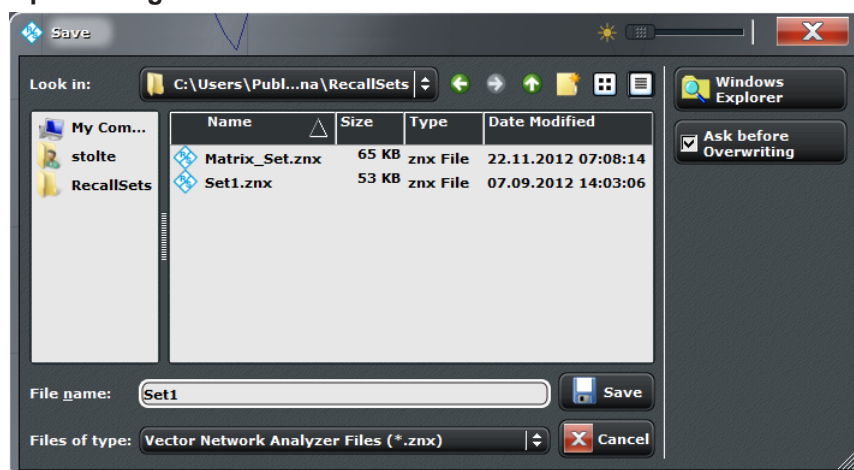

Specifies the name and location of a particular file (e.g. a VNA recall set file) to open:

- "Look in:" specifies the directory to be listed. The icons to the right of the pull-down list are provided for easy navigation in the file system (place the cursor on the icons to obtain "What's this?" help).
- "Windows Explorer" opens the selected directory in Windows Explorer.
- "File name:" specifies a file name to save the current data (e.g. the recall set). The analyzer adds the extension (e.g. \*.znx) in the "Files of type:" field.
- "Files of type:" filters the displayed files by type (e.g. recall set files, \*.znx).
- "Open" opens selected file and closes the dialog.
- "Cancel" closes the dialog without opening a file.

**Tip:** The "Open" dialog is used to open various file types (cal kit data, limit lines, sweep segment lists, ...). Depending on its use the dialog is opened with different captions, file locations and file type filters. File locations (directories) are remembered when the dialog is closed. To restore default directories use the "Presets" tab of the "SYSTEM > SETUP > Setup > System Config" dialog. See [Chapter 4.6.2.1, "Presets"](#), on page 334.

### Save dialog

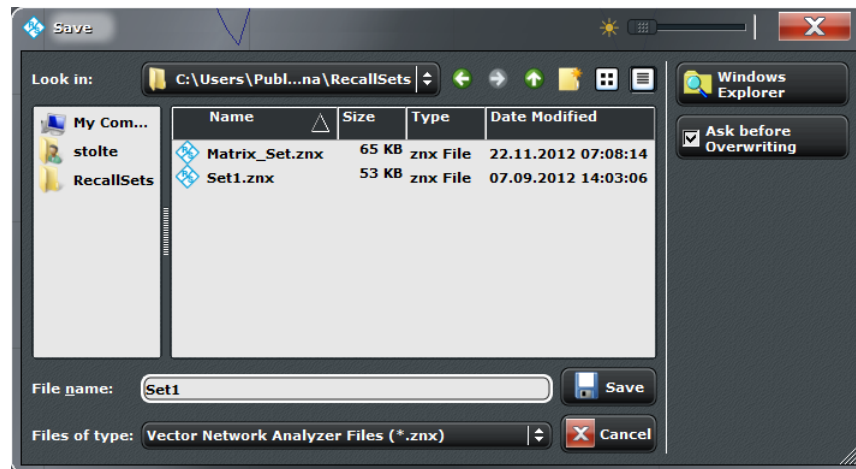

Specifies the name and location of a particular file (e.g. a VNA recall set file) to save:

- "Look in:" specifies the drive and directory in which the data is stored. The icons to the right of the pull-down list are provided for easy navigation in the file system (place the cursor on the icons to obtain "What's this?" help).
- "File name:" specifies a file name to save the current data (e.g. the recall set). The analyzer adds the extension (e.g. \*.znx) in the "Files of type:" field.
- "Files of type:" selects a particular file type (e.g. recall set files, \*.znx) for the created file.
- "Save" saves the data (e.g. the active recall set) in the selected file and directory and closes the dialog.
- "Cancel" closes the dialog without saving the data.
- "Windows Explorer" opens the selected directory in Windows Explorer.

**Tip:** The "Save" dialog is used to store various data types (e.g. cal kit data, limit lines, sweep segment lists, ...). Depending on its use the dialog is opened with different file locations and file type filters. File locations (directories) are remembered when the dialog is closed. To restore default directories use the "Presets" tab of the "SYSTEM > SETUP > Setup > System Config" dialog. See [Chapter 4.6.2.1, "Presets"](#), on page 334.

### 3.2.4 Display Formats and Diagram Types

A display format defines how the set of (complex) measurement points is converted and displayed in a diagram. The display formats in the "TRACE > FORMAT" menu use the following basic diagram types:

- Cartesian (rectangular) diagrams are used for all display formats involving a conversion of the measurement data into a real (scalar) quantity, i.e. for "dB Mag", "Phase", "Delay", "SWR", "Lin Mag", "Real", "Imag" and "Unwrapped Phase".
- Polar diagrams are used for the display format "Polar" and show a complex quantity as a vector in a single trace.
- Smith charts are used for the display format "Smith". They show a complex quantity like polar diagrams but with grid lines of constant real and imaginary part of the impedance.

- Inverted Smith charts are used for the display format "Inverted Smith". They show a complex quantity like polar diagrams but with grid lines of constant real and imaginary part of the admittance.



The analyzer allows arbitrary combinations of display formats and measured quantities ("TRACE > MEAS"). Nevertheless, in order to extract useful information from the data, it is important to select a display format which is appropriate to the analysis of a particular measured quantity; see [Chapter 3.2.4.6, "Measured Quantities and Display Formats"](#), on page 47.

### 3.2.4.1 Cartesian Diagrams

Cartesian diagrams are rectangular diagrams used to display a scalar quantity as a function of the stimulus variable (frequency / power / time).

- The stimulus variable appears on the horizontal axis (x-axis), scaled linearly (sweep types "Lin Frequency", "Power", "Time", "CW Mode") or logarithmically (sweep type "Log Frequency").
- The measured data (response values) appears on the vertical axis (y-axis). The scale of the y-axis is linear with equidistant grid lines although the y-axis values may be obtained from the measured data by non-linear conversions.

The following examples show the same trace in Cartesian diagrams with linear and logarithmic x-axis scaling.

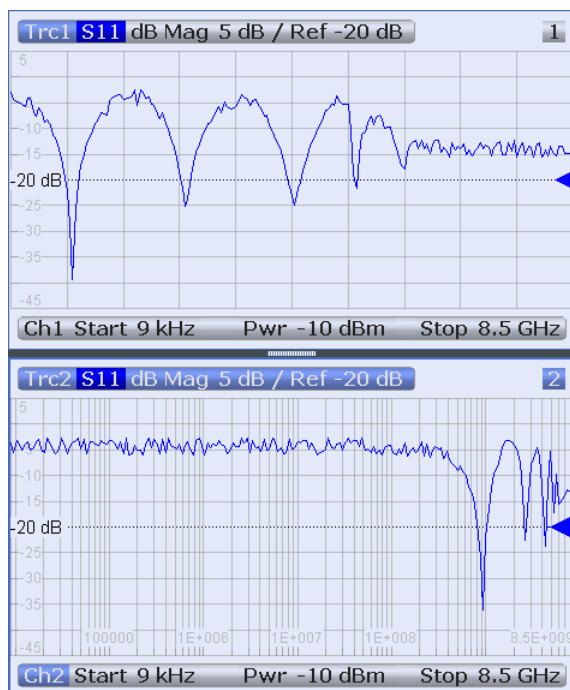



### 3.2.4.2 Conversion of Complex into Real Quantities

The results in the "TRACE > MEAS" menu can be divided into two groups: "Stability" factors and "Power Sensor" results are real, while all other results are complex.

The following table shows how the response values in the different Cartesian diagrams are calculated from the complex measurement values  $z = x + j y$  (where  $x$ ,  $y$ ,  $z$  are functions of the sweep variable). The formulas also hold for real results, which are treated as complex values with zero imaginary part ( $y = 0$ ).

Trace Format	Description	Formula
Lin Mag	Magnitude of $z$ , unconverted	$ z  = \sqrt{x^2 + y^2}$
dB Mag	Magnitude of $z$ in dB	$\text{dB Mag}(z) = 20 * \log z  \text{ dB}$
Phase	Phase of $z$	$\varphi(z) = \arctan(y/x)$
Real	Real part of $z$	$\text{Re}(z) = x$
Imag	Imaginary part of $z$	$\text{Im}(z) = y$
SWR	(Voltage) Standing Wave Ratio	$\text{SWR} = (1 +  z ) / (1 -  z )$
Delay	Group delay, neg. derivative of the phase response	$-d\varphi(z) / d\Omega \quad (\Omega = 2\pi * f)$



An extended range of formats and conversion formulas is available for markers. To convert any point on a trace, create a marker and select the appropriate marker format. Marker and trace formats can be selected independently.

### 3.2.4.3 Polar Diagrams

Polar diagrams show the measured data (response values) in the complex plane with a horizontal real axis and a vertical imaginary axis. The grid lines correspond to points of equal magnitude and phase.

- The magnitude of the response values corresponds to their distance from the center. Values with the same magnitude are located on circles.
- The phase of the response values is given by the angle from the positive horizontal axis. Values with the same phase are on straight lines originating at the center.

The following example shows a polar diagram with a marker used to display a pair of stimulus and response values.

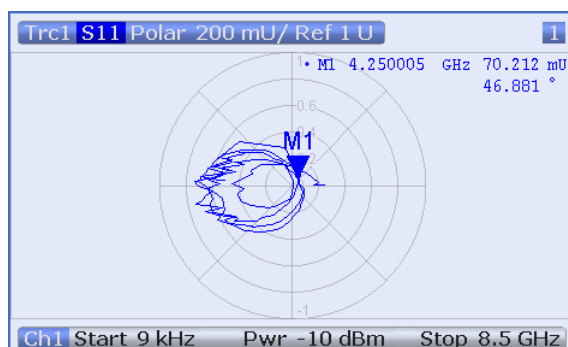

### Example: Reflection coefficients in polar diagrams

If the measured quantity is a complex reflection coefficient ( $S_{11}$ ,  $S_{22}$  etc.), then the center of the polar diagram corresponds to a perfect load  $Z_0$  at the input test port of the DUT (no reflection, matched input), whereas the outer circumference ( $|S_{ii}| = 1$ ) represents a totally reflected signal.

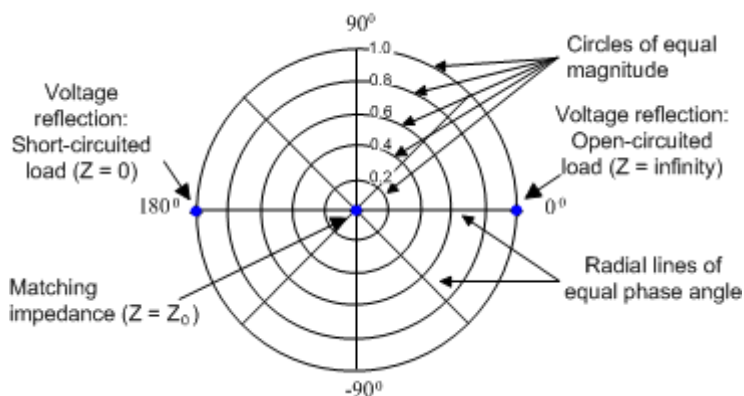

Examples for definite magnitudes and phase angles:

- The magnitude of the reflection coefficient of an open circuit ( $Z = \text{infinity}$ ,  $I = 0$ ) is one, its phase is zero.
- The magnitude of the reflection coefficient of a short circuit ( $Z = 0$ ,  $U = 0$ ) is one, its phase is  $-180$  deg.

#### 3.2.4.4 Smith Chart

The Smith chart is a circular diagram that maps the complex reflection coefficients  $S_{ii}$  to normalized impedance values. In contrast to the polar diagram, the scaling of the diagram is not linear. The grid lines correspond to points of constant resistance and reactance.

- Points with the same resistance are located on circles.
- Points with the same reactance produce arcs.

The following example shows a Smith chart with a marker used to display the stimulus value, the complex impedance  $Z = R + j X$  and the equivalent inductance  $L$ .

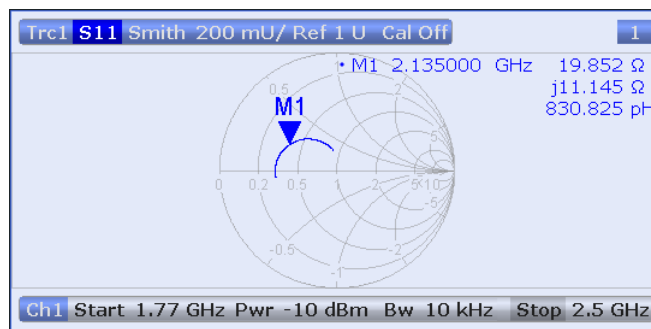

A comparison of the Smith chart, the inverted Smith chart and the polar diagram reveals many similarities between the two representations. In fact the shape of a trace does not change at all if the display format is switched from "Polar" to "Smith" or "Inverted Smith" – the analyzer simply replaces the underlying grid and the default marker format.

### Smith chart construction

In a Smith chart, the impedance plane is reshaped so that the area with positive resistance is mapped into a unit circle.

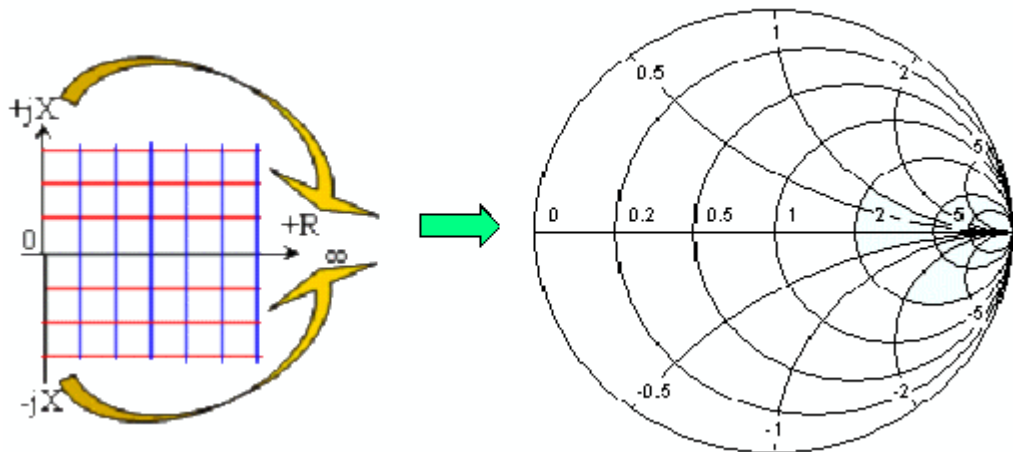

The basic properties of the Smith chart follow from this construction:

- The central horizontal axis corresponds to zero reactance (real impedance). The center of the diagram represents  $Z/Z_0 = 1$  which is the reference impedance of the system (zero reflection). At the left and right intersection points between the horizontal axis and the outer circle, the impedance is zero (short) and infinity (open).
- The outer circle corresponds to zero resistance (purely imaginary impedance). Points outside the outer circle indicate an active component.
- The upper and lower half of the diagram correspond to positive (inductive) and negative (capacitive) reactive components of the impedance, respectively.

**Example: Reflection coefficients in the Smith chart**

If the measured quantity is a complex reflection coefficient  $\Gamma$  (e.g.  $S_{11}$ ,  $S_{22}$ ), then the unit Smith chart can be used to read the normalized impedance of the DUT. The coordinates in the normalized impedance plane and in the reflection coefficient plane are related as follows (see also: definition of matched-circuit (converted) impedances):

$$Z / Z_0 = (1 + \Gamma) / (1 - \Gamma)$$

From this equation it is easy to relate the real and imaginary components of the complex resistance to the real and imaginary parts of  $\Gamma$ :

$$R = \text{Re}(Z / Z_0) = \frac{1 - \text{Re}(\Gamma)^2 - \text{Im}(\Gamma)^2}{[1 - \text{Re}(\Gamma)]^2 + \text{Im}(\Gamma)^2},$$

$$X = \text{Im}(Z / Z_0) = \frac{2 \cdot \text{Im}(\Gamma)}{[1 - \text{Re}(\Gamma)]^2 + \text{Im}(\Gamma)^2}$$

According to the two equations above, the graphical representation in a Smith chart has the following properties:

- Real reflection coefficients are mapped to real impedances (resistances).
- The center of the  $\Gamma$  plane ( $\Gamma = 0$ ) is mapped to the reference impedance  $Z_0$ , whereas the circle with  $|\Gamma| = 1$  is mapped to the imaginary axis of the  $Z$  plane.
- The circles for the points of equal resistance are centered on the real axis and intersect at  $Z = \text{infinity}$ . The arcs for the points of equal reactance also belong to circles intersecting at  $Z = \text{infinity}$  (open circuit point  $(1, 0)$ ), centered on a straight vertical line.

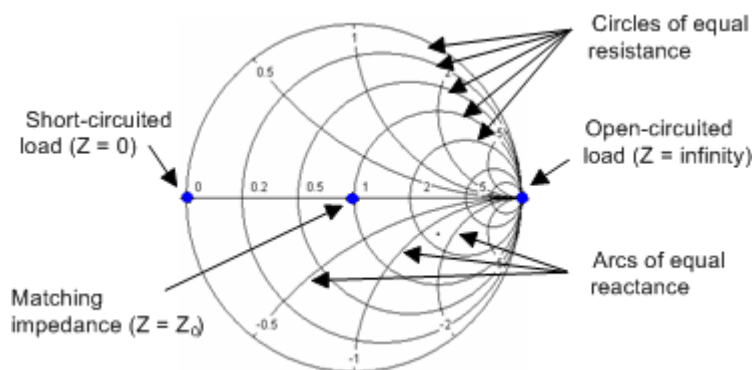

Examples for special points in the Smith chart:

- The magnitude of the reflection coefficient of an open circuit ( $Z = \text{infinity}$ ,  $\Gamma = 1$ ) is one, its phase is zero.
- The magnitude of the reflection coefficient of a short circuit ( $Z = 0$ ,  $\Gamma = -1$ ) is one, its phase is  $-180$  deg.

### 3.2.4.5 Inverted Smith Chart

The inverted Smith chart is a circular diagram that maps the complex reflection coefficients  $S_{ij}$  to normalized admittance values. In contrast to the polar diagram, the scaling of the diagram is not linear. The grid lines correspond to points of constant conductance and susceptance.

- Points with the same conductance are located on circles.
- Points with the same susceptance produce arcs.

The following example shows an inverted Smith chart with a marker used to display the stimulus value, the complex admittance  $Y = G + j B$  and the equivalent inductance  $L$ .

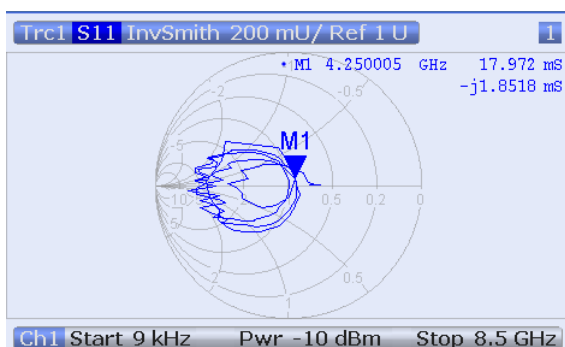

A comparison of the inverted Smith chart with the Smith chart and the polar diagram reveals many similarities between the different representations. In fact the shape of a trace does not change at all if the display format is switched from "Polar" to "Inverted Smith" or "Smith" – the analyzer simply replaces the underlying grid and the default marker format.

#### Inverted Smith chart construction

The inverted Smith chart is point-symmetric to the Smith chart:

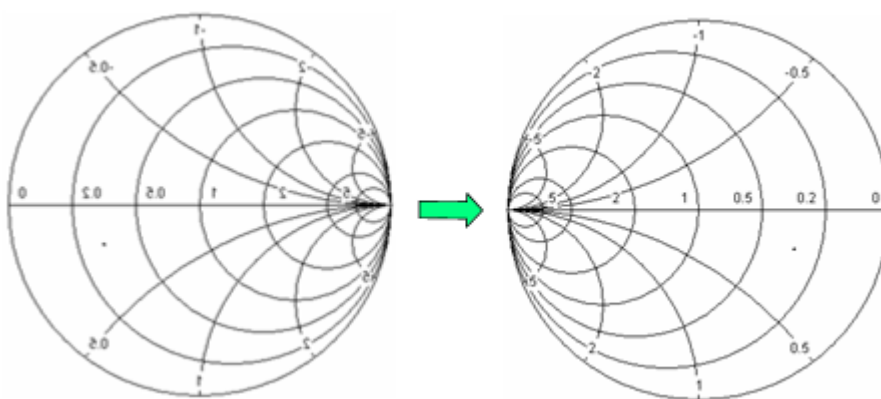

The basic properties of the inverted Smith chart follow from this construction:

- The central horizontal axis corresponds to zero susceptance (real admittance). The center of the diagram represents  $Y/Y_0 = 1$ , where  $Y_0$  is the reference admittance of the system (zero reflection). At the left and right intersection points between the

horizontal axis and the outer circle, the admittance is infinity (short) and zero (open).

- The outer circle corresponds to zero conductance (purely imaginary admittance). Points outside the outer circle indicate an active component.
- The upper and lower half of the diagram correspond to negative (inductive) and positive (capacitive) susceptive components of the admittance, respectively.

#### Example: Reflection coefficients in the inverted Smith chart

If the measured quantity is a complex reflection coefficient  $\Gamma$  (e.g.  $S_{11}$ ,  $S_{22}$ ), then the unit inverted Smith chart can be used to read the normalized admittance of the DUT. The coordinates in the normalized admittance plane and in the reflection coefficient plane are related as follows (see also: definition of matched-circuit (converted) admittances):

$$Y / Y_0 = (1 - \Gamma) / (1 + \Gamma)$$

From this equation it is easy to relate the real and imaginary components of the complex admittance to the real and imaginary parts of  $\Gamma$ :

$$G = \operatorname{Re}(Y / Y_0) = \frac{1 - \operatorname{Re}(\Gamma)^2 - \operatorname{Im}(\Gamma)^2}{[1 + \operatorname{Re}(\Gamma)]^2 + \operatorname{Im}(\Gamma)^2}$$

$$B = \operatorname{Im}(Y / Y_0) = \frac{-2 \cdot \operatorname{Im}(\Gamma)}{[1 + \operatorname{Re}(\Gamma)]^2 + \operatorname{Im}(\Gamma)^2} ,$$

According to the two equations above, the graphical representation in an inverted Smith chart has the following properties:

- Real reflection coefficients are mapped to real admittances (conductances).
- The center of the  $\Gamma$  plane ( $\Gamma = 0$ ) is mapped to the reference admittance  $Y_0$ , whereas the circle with  $|\Gamma| = 1$  is mapped to the imaginary axis of the  $Y$  plane.
- The circles for the points of equal conductance are centered on the real axis and intersect at  $Y = \text{infinity}$ . The arcs for the points of equal susceptance also belong to circles intersecting at  $Y = \text{infinity}$  (short circuit point  $(-1, 0)$ ), centered on a straight vertical line.

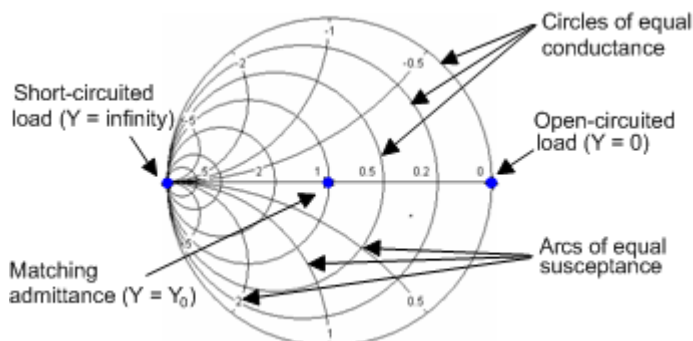

Examples for special points in the inverted Smith chart:

- The magnitude of the reflection coefficient of a short circuit ( $Y = \text{infinity}$ ,  $U = 0$ ) is one, its phase is  $-180$  deg.
- The magnitude of the reflection coefficient of an open circuit ( $Y = 0$ ,  $I = 0$ ) is one, its phase is zero.

### 3.2.4.6 Measured Quantities and Display Formats

The analyzer allows any combination of a display format and a measured quantity. The following rules can help to avoid inappropriate formats and find the format that is ideally suited to the measurement task.

- All formats are suitable for the analysis of reflection coefficients  $S_{ij}$ . The formats "SWR", "Smith" and "Inverted Smith" lose their original meaning (standing wave ratio, normalized impedance or admittance) if they are used for transmission S-parameters, ratios and other quantities.
- The complex "Impedances", "Admittances", "Z-parameters", and "Y-parameters" are generally displayed in one of the Cartesian diagrams with linear vertical axis scale or in a polar diagram.
- The real "Stability Factors" are generally displayed in a linear Cartesian diagram ("Lin Mag" or "Real"). In complex formats, real numbers represent complex numbers with zero imaginary part.

The following table gives an overview of recommended display formats.

	<b>Complex dimensionless quantities: S-parameters and ratios</b>	<b>Complex quantities with dimensions: Wave quantities, Z-parameters, Y-parameters, impedances, admittances</b>	<b>Real quantities: Stability Factors</b>
Lin Mag	ON	ON (default for Z-parameters, Y-parameters, impedances, admittances)	ON (default)
dB Mag	ON (default)	ON (default for wave quantities)	–
Phase	ON	ON	–
Real	ON	ON	ON
Imag	ON	ON	–
Unwrapped Phase	ON	ON	–
Smith	ON (reflection coefficients $S_{ij}$ )	–	–
Polar	ON	–	–
Inverted Smith	ON (reflection coefficients $S_{ij}$ )	–	–
SWR	ON (reflection coefficients $S_{ij}$ )	–	–
Delay	ON (transmission coefficients $S_{ij}$ )	–	–

The default formats are activated automatically when the measured quantity is changed.

### 3.3 Measurement Results

This section gives an overview of the measurement results of the network analyzer and the meaning of the different measured quantities. All quantities can be selected in the "TRACE > MEAS >" softtool panels.



The definitions in this and the following sections apply to general n-port DUTs. An analyzer with a smaller number of test ports provides a subset of the n-port quantities.

#### 3.3.1 S-Parameters

S-parameters are the basic measured quantities of a network analyzer. They describe how the DUT modifies a signal that is transmitted or reflected in forward or reverse direction. For a 2-port measurement the signal flow is as follows.

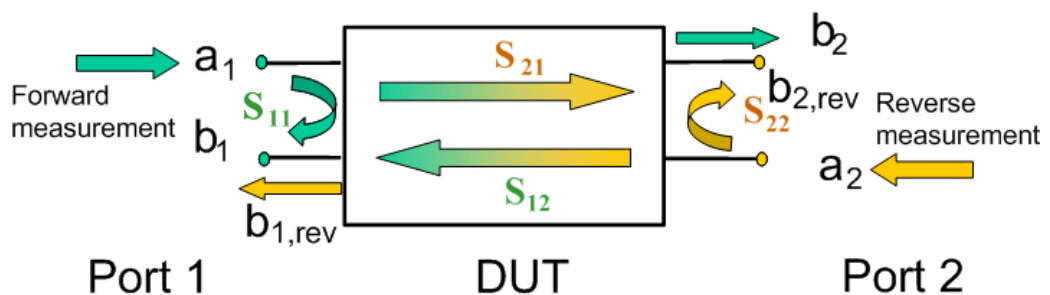

The figure above is sufficient for the definition of S-parameters but does not necessarily show the complete signal flow. In fact, if the source and load ports are not ideally matched, part of the transmitted waves are reflected off the receiver ports so that an additional  $a_2$  contribution occurs in forward measurements, and an  $a_1$  contribution occurs in reverse measurements. The 7-term calibration types Txx take these additional contributions into account.

The scattering matrix links the incident waves  $a_1$ ,  $a_2$  to the outgoing waves  $b_1$ ,  $b_2$  according to the following linear equation:

$$\begin{bmatrix} b_1 \\ b_2 \end{bmatrix} = \begin{bmatrix} S_{11} & S_{12} \\ S_{21} & S_{22} \end{bmatrix} * \begin{bmatrix} a_1 \\ a_2 \end{bmatrix}$$

#### Meaning of 2-port S-parameters

The four 2-port S-parameters can be interpreted as follows:

- $S_{11}$  is the reflection coefficient of port 1, i.e. the ratio between outgoing wave  $b_1$  and incident wave  $a_1$  in a forward measurement with matched port 2:  
 $S_{11} = b_1 / a_1$  , if  $|a_1| > 0$  and  $a_2 = 0$
- $S_{21}$  is the forward transmission coefficient, defined as the ratio between outgoing wave  $b_2$  and incident wave  $a_1$  in a forward measurement with matched port 2:  
 $S_{21} = b_2 / a_1$  , if  $|a_1| > 0$  and  $a_2 = 0$



- $S_{12}$  is the reverse transmission coefficient, defined as the ratio between outgoing wave  $b_1$  and incident wave  $a_2$  in a forward measurement with matched port 1:  
 $S_{12} = b_1 / a_2$  , if  $|a_2| > 0$  and  $a_1 = 0$
- $S_{22}$  is the reflection coefficient of port 2, i.e. the ratio between outgoing wave  $b_2$  and incident wave  $a_2$  in a forward measurement with matched port 1:  
 $S_{22} = b_2 / a_2$  , if  $|a_2| > 0$  and  $a_1 = 0$



For a unidirectional R&S ZND (see [Chapter 3.1.4.2, "R&S ZND: Unidirectional vs. Bidirectional Operation"](#), on page 16) neither "reverse direction" S-Parameters  $S_{12}$  nor "bidirectional" calibration types are available.

### Meaning of squared amplitudes

The squared amplitudes of the incident and outgoing waves and of the matrix elements have a simple meaning:

**Table 3-3: Squared S-parameters**

$ a_i ^2$	Available incident power (= the power provided by a generator with a source impedance equal to the reference impedance $Z_0$ ) at DUT port $i=1,2$
$ b_i ^2$	Reflected power at DUT port $i=1,2$
$10 \log S_{ii} ^2 = 20 \log S_{ii} $	Reflection loss at DUT port $i=1,2$
$10 \log S_{21} ^2 = 20 \log S_{21} $	Insertion loss of forward transmission
$10 \log S_{12} ^2 = 20 \log S_{12} $	Insertion loss of reverse transmission

## 3.3.2 Impedance Parameters

An impedance is the complex ratio between a voltage and a current. The analyzer provides two independent sets of impedance parameters:

- Converted impedances (each impedance parameter is obtained from a single S-parameter)
- Z-parameters (complete description of the n-port DUT)

### 3.3.2.1 Converted Impedances

The converted impedance parameters describe the input impedances of a DUT with fully matched outputs. In the figures below the indices  $i$  and  $j$  number the analyzer/DUT ports,  $Z_{0i}$  is the reference impedance at the DUT port  $i$ .

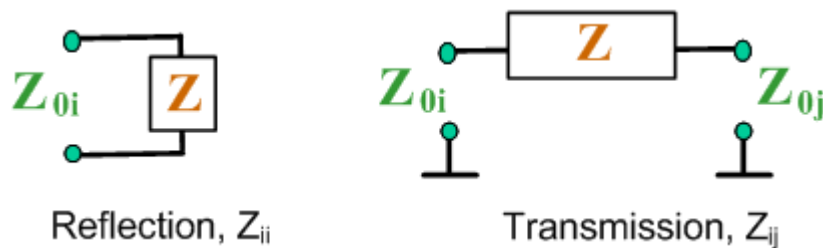

The analyzer converts a single measured S-parameter to determine the corresponding converted impedance. As a result, converted Z-parameters cannot completely describe general n-port DUTs:

- A reflection parameter  $Z_{ii}$  completely describes a one-port DUT. For n-port DUTs ( $n > 1$ ) the reflection parameters  $Z_{ii}$  describe the input impedances at ports  $i$  ( $i = 1$  to  $n$ ) under the condition that each of the other ports is terminated with its reference impedance (matched-circuit parameters).
- A two-port transmission parameter  $Z_{ij}$  ( $i \neq j$ ) can describe a pure serial impedance between the two ports.

#### Relation with S-parameters

The converted impedances  $Z_{ii}$  are calculated from the reflection S-parameters  $S_{ii}$  according to:

$$Z_{ii} = Z_{0i} \frac{1 + S_{ii}}{1 - S_{ii}}$$

The transmission parameters are calculated according to:

$$Z_{ij} = 2 \cdot \frac{\sqrt{Z_{0i} \cdot Z_{0j}}}{S_{ij}} - (Z_{0i} + Z_{0j}), \quad i \neq j,$$

The converted admittances are defined as the inverse of the impedances.



For a unidirectional R&S ZND (see [Chapter 3.1.4.2, "R&S ZND: Unidirectional vs. Bidirectional Operation"](#), on page 16) "reverse direction" converted impedances  $Z_{i2}$  are not available.

Examples:

- $Z_{11}$  is the input impedance of a 2-port DUT that is terminated at its output with the reference impedance  $Z_0$  (matched-circuit impedance measured in a forward reflection measurement).



You can also read the converted impedances in a reflection coefficient measurement from the Smith chart.

### 3.3.2.2 Z-Parameters

The Z-parameters describe the impedances of a DUT with open output ports ( $I = 0$ ). The analyzer provides the full set of Z-parameters including the transfer impedances (i.e. the complete  $n \times n$  Z-matrix for an  $n$  port DUT).

This means that Z-parameters can be used as an alternative to S-parameters (or Y-parameters) in order to completely characterize a linear  $n$ -port network.

#### 2-Port Z-Parameters

In analogy to S-parameters, Z-parameters are expressed as  $Z_{ij}$ , where  $i$  denotes the measured and  $j$  the stimulated port.

The Z-parameters for a two-port are based on a circuit model that can be expressed with two linear equations:

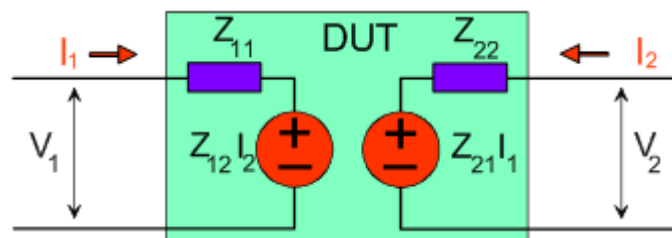

$$V_1 = Z_{11}I_1 + Z_{12}I_2$$

$$V_2 = Z_{21}I_1 + Z_{22}I_2$$

#### Meaning of Z-parameters

The four 2-port Z-parameters can be interpreted as follows:

- $Z_{11}$  is the input impedance, defined as the ratio of the voltage  $V_1$  to the current  $I_1$ , measured at port 1 (forward measurement with open output,  $I_2 = 0$ ).
- $Z_{21}$  is the forward transfer impedance, defined as the ratio of the voltage  $V_2$  to the current  $I_1$  (forward measurement with open output,  $I_2 = 0$ ).
- $Z_{12}$  is the reverse transfer impedance, defined as the ratio of the voltage  $V_1$  to the current  $I_2$  (reverse measurement with open input,  $I_1 = 0$ ).
- $Z_{22}$  is the output impedance, defined as the ratio of the voltage  $V_2$  to the current  $I_2$ , measured at port 2 (reverse measurement with open input,  $I_1 = 0$ ).

Z-parameters can be easily extended to describe circuits with more than two ports or several modes of propagation.



For a unidirectional R&S ZND (see [Chapter 3.1.4.2, "R&S ZND: Unidirectional vs. Bidirectional Operation"](#), on page 16) Z-Parameters are not available.

### 3.3.3 Admittance Parameters

An admittance is the complex ratio between a current and a voltage. The analyzer provides two independent sets of admittance parameters:

- Converted admittances (each admittance parameter is obtained from a single S-parameter)
- Y-parameters (complete description of the n-port DUT)

#### 3.3.3.1 Converted Admittances

The converted admittance parameters describe the input admittances of a DUT with fully matched outputs. The converted admittances are the inverse of the converted impedances.

The analyzer converts a single measured S-parameter to determine the corresponding converted admittance. As a result, converted Y-parameters cannot completely describe general n-port DUTs:

- A reflection parameter  $Y_{ii}$  completely describes a one-port DUT. For n-port DUTs ( $n > 1$ ) the reflection parameters  $Y_{ii}$  describe the input admittances at ports  $i$  ( $i = 1$  to  $n$ ) under the condition that each of the other ports is terminated with its reference impedance (matched-circuit parameters).
- A two-port transmission parameter  $Y_{ij}$  ( $i \neq j$ ) can describe a pure serial impedance between the two ports.

#### Relation with S-parameters

The converted admittances  $Y_{ii}$  are calculated from the reflection S-parameters  $S_{ii}$  according to:

$$Y_{ii} = \frac{1}{Z_{0i}} \frac{1 - S_{ii}}{1 + S_{ii}} = 1/Z_{ii}$$

The transmission parameters are calculated according to:

$$Y_{ij} = \frac{S_{ij}}{2 \cdot \sqrt{Z_{0i} \cdot Z_{0j}} - S_{ij} \cdot (Z_{0i} + Z_{0j})} = 1/Z_{ij}, \quad i \neq j, \quad i, j = 1, \dots, 99$$



For a unidirectional R&S ZND (see [Chapter 3.1.4.2, "R&S ZND: Unidirectional vs. Bidirectional Operation"](#), on page 16) "reverse direction" converted admittances  $Y_{i2}$  are not available.

Examples:

- $Y_{11}$  is the input admittance of a 2-port DUT that is terminated at its output with the reference impedance  $Z_0$  (matched-circuit admittance measured in a forward reflection measurement).



You can also read the converted admittances in a reflection coefficient measurement from the inverted Smith chart.

### 3.3.3.2 Y-Parameters

The Y-parameters describe the admittances of a DUT with output ports terminated in a short circuit ( $V = 0$ ). The analyzer provides the full set of Y-parameters including the transfer admittances (i.e. the complete  $n \times n$  Y-matrix for an  $n$  port DUT).

This means that Y-parameters can be used as an alternative to S-parameters (or Z-parameters) in order to completely characterize a linear  $n$ -port network.

#### 2-Port Y-Parameters

In analogy to S-parameters, Y-parameters are expressed as  $Y_{\langle out \rangle \langle in \rangle}$ , where  $\langle out \rangle$  and  $\langle in \rangle$  denote the output and input port numbers of the DUT. In analogy to Z-parameters, the Y-parameters for a two-port are based on a circuit model that can be expressed with two linear equations:

$$I_1 = Y_{11}V_1 + Y_{12}V_2$$

$$I_2 = Y_{21}V_1 + Y_{22}V_2$$

#### Meaning of Y-parameters

The four 2-port Y-parameters can be interpreted as follows:

- $Y_{11}$  is the input admittance, defined as the ratio of the current  $I_1$  to the voltage  $V_1$ , measured at port 1 (forward measurement with output terminated in a short circuit,  $V_2 = 0$ ).
- $Y_{21}$  is the forward transfer admittance, defined as the ratio of the current  $I_2$  to the voltage  $V_1$  (forward measurement with output terminated in a short circuit,  $V_2 = 0$ ).
- $Y_{12}$  is the reverse transfer admittance, defined as the ratio of the current  $I_1$  to the voltage  $V_2$  (reverse measurement with input terminated in a short circuit,  $V_1 = 0$ ).
- $Y_{22}$  is the output admittance, defined as the ratio of the current  $I_2$  to the voltage  $V_2$ , measured at port 2 (reverse measurement with input terminated in a short circuit,  $V_1 = 0$ ).

Y-parameters can be easily extended to describe circuits with more than two ports or several modes of propagation.



For a unidirectional R&S ZND (see [Chapter 3.1.4.2, "R&S ZND: Unidirectional vs. Bidirectional Operation"](#), on page 16) Y-Parameters are not available.

### 3.3.4 Wave Quantities and Ratios

The elements of the S-, Z- and Y-matrices represent fixed ratios of complex wave amplitudes. As long as the assumption of linearity holds, the S-, Z- and Y-parameters are independent of the source power.

The network analyzer provides two additional sets of measurement parameters which have a unambiguous meaning even if the DUT is measured outside its linear range:

- "Wave Quantities" provide the power of any of the transmitted or received waves.
- "Ratios" provide the complex ratio of any combination of transmitted or received wave quantities.



In contrast to S-, Z- and Y-parameters, wave quantities and ratios are not system-error corrected. A power calibration can be applied to wave quantities and ratios.

#### 3.3.4.1 Wave Quantities

A wave quantity measurement provides the power of any of the transmitted or received waves. The power can be displayed in voltage units (e.g. "V" or "dBmV") or equivalent power units (e.g. "W" or "dBm").



#### Examples for using wave quantities

The wave quantities provide the power at the different receive ports of the analyzer. This is different from an S-parameter measurement, where the absolute power of a linear device is cancelled. Wave quantities are therefore suitable for the following measurement tasks:

- Analysis of non-linearities of the DUT.
- Use of the analyzer as a selective power meter.  
To increase the accuracy or correct a possible attenuation in the source signal path, it is recommended to perform a power calibration.

The notation for wave quantities includes the direction and the test port number. Additionally, the source port must be specified. The letter a indicates a transmitted wave, b a received wave.

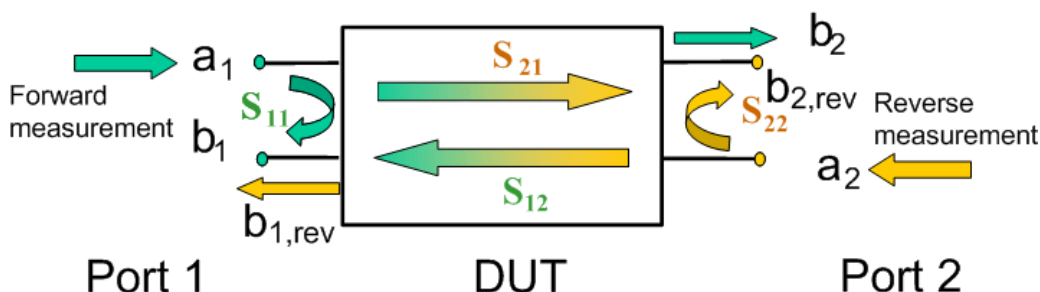

Examples:

- $a_1$  Src Port 1 is the outgoing wave at test port 1. In a standard S-parameter measurement, this wave is fed to the input port (port 1) of the DUT (forward measurement).
- $b_1$  Src Port 1 is the incoming wave at test port 1. In a standard S-parameter measurement, this is the reflected wave at port 1 of the DUT (forward measurement).



For a unidirectional R&S ZND (see [Chapter 3.1.4.2, "R&S ZND: Unidirectional vs. Bidirectional Operation"](#), on page 16) the reverse direction wave quantities  $a_2$  and  $b_{i,rev}$  are not available.

### 3.3.4.2 Ratios

A ratio measurement provides the complex ratio of any combination of transmitted or received wave amplitudes. Ratios complement the S-parameter measurements, where only ratios of the form  $b_i/a_j$  (ratio of the incoming wave to the outgoing wave at the test ports  $i$  and  $j$  of the DUT) are considered.



For a unidirectional R&S ZND (see [Chapter 3.1.4.2, "R&S ZND: Unidirectional vs. Bidirectional Operation"](#), on page 16) ratios involving the reverse wave quantities  $a_2$  and  $b_{i,rev}$  are not available.



#### Examples for using ratios

A measurement of ratios is particularly suitable for the following test scenarios:

- The test setup or some of its components (e.g. active components or non-reciprocal devices) do not allow a system error correction so that a complete S-parameter measurement is not possible.
- The test setup contains frequency-converting components so that the transmitted and the received waves are at different frequencies.
- A ratio of two arbitrary waves that is not an element of the S-matrix (e.g. a ratio of the form  $a_i/a_j$ ) is needed.

The notation for ratios includes the two waves with their directions and test port numbers. Additionally, the source port must be specified. In analogy to wave quantities, the letter  $a$  indicates an outgoing wave,  $b$  an incoming wave.

Examples:

- $b_2/a_1$  Src Port 1 is the ratio of the outgoing wave  $b_2$  at port 2 and the incident wave  $a_1$  at port 1; this corresponds to the S-parameter  $S_{21}$  (forward transmission coefficient).
- $b_1/a_1$  Src Port 1 is the ratio of the wave quantities  $b_1$  and  $a_1$ , measured at PORT 1; this corresponds to the S-parameter  $S_{11}$  (input reflection coefficient).

### 3.3.4.3 Detector Settings

The "Detector" settings select the algorithm that is used to calculate the displayed measurement points from the raw data. The "Detector" can be selected in the "More Ratios" and "More Wave Quantities" dialogs.

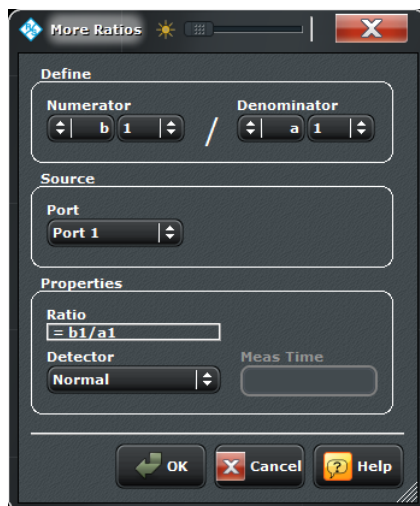

The following detectors are available:

- **Normal** selects the default detector mode where each measurement point is displayed without modification as soon as it is recognized to be valid. The analyzer then proceeds to the next sweep point. Normal detector mode ensures that the measurement is performed at maximum speed and that a meaningful complex result is obtained.
- **AVG Real Imag** collects all valid results at each sweep point during the "Meas. Time" set in the "More Ratios" or "More Wave Quantities" dialog and calculates the complex arithmetic mean value of these results. This yields the complex average of the wave quantities or ratios. Averaging tends to remove statistical fluctuations (e.g. noise contributions) from the measured signal.
- **AVG Mag Phase** collects all valid results at each sweep point during the "Meas. Time" set in the "More Ratios" or "More Wave Quantities" dialog and calculates the root mean square (RMS) of the linear magnitude of these results. This yields the magnitude of the measurement point. Note that the phase is not evaluated in this process so that complex conversions (e. g. the calculation of real and imaginary values) do not really make sense.



#### Combining different detectors

The detector setting in the "More Ratios" menu affects the ratio of a numerator and a denominator wave quantity. This does not place any restrictions on the measurement functionality of the analyzer, because ratios can also be formed by measuring the numerator and denominator individually and using the trace functions. A possible application is the comparison of different detector settings for a particular trace.





### Error Messages

The analyzer generates a warning if the selected measurement time for the "AVG..." detectors is too long. At the same time, bit no. 15 in the ...INTEGRITY:HARDWARE status register is set. Reduce the measurement time and/or reduce the IF bandwidth until the warning disappears. A warning also appears if the measurement time for the "AVG..." detectors is too short. Increase the measurement time and/or increase the IF bandwidth until the warning disappears.

### 3.3.5 Unbalance-Balance Conversion

Unbalance-balance conversion is the simulation of one or more unbalance-balance transformers (baluns) integrated in the measurement circuit in order to convert the DUT ports from an unbalanced state into a balanced state and virtually separate the differential and common mode signals. The analyzer measures the unbalanced state but converts the results and calculates mixed mode parameters, e.g. mixed mode S-parameters. No physical transformer is needed.

To perform balanced measurements, a pair of physical analyzer ports is combined to form a logical port. The balanced port of the DUT is directly connected to the analyzer ports. For a two-port analyzer, a single balanced port can be defined.

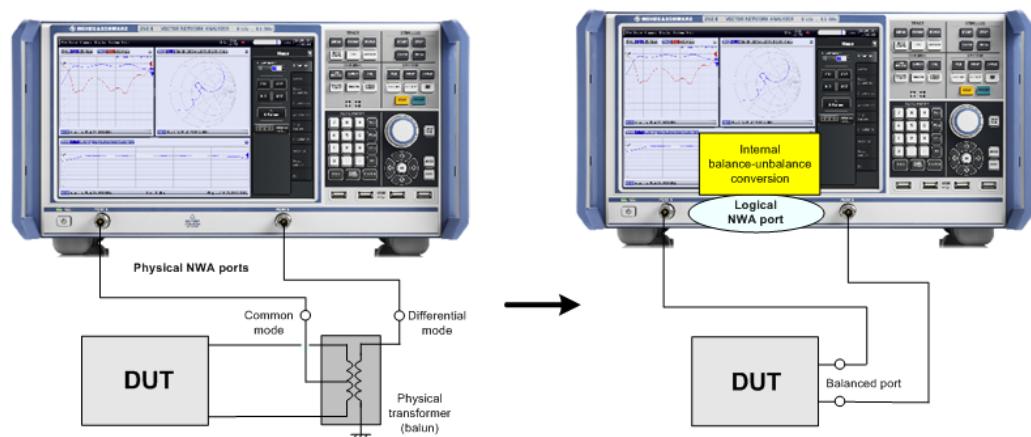

Unbalance-balance conversion avoids the disadvantages of real transformers:

- There is no need to fabricate test fixtures with integrated baluns for each type of DUT.
- The measurement is not impaired by the non-ideal characteristics of the balun (e.g. error tolerances, limited frequency range).
- Calibration can be performed at the DUT's ports. If necessary (e.g. to compensate for the effect of a test fixture), it is possible to shift the calibration plane using length offset parameters.
- Differential and common mode parameters can be evaluated with a single test setup.



For a unidirectional R&S ZND (see [Chapter 3.1.4.2, "R&S ZND: Unidirectional vs. Bidirectional Operation"](#), on page 16) balanced measurements are not possible.

### 3.3.5.1 Balanced Port Configurations

Defining a balanced logical port requires two physical ports.

It is possible to assign arbitrary, independent reference impedance values to the differential and common mode of the single balanced port.

**Example:**

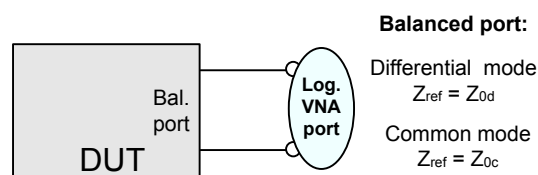

The "Balanced Ports" dialog allows to switch to balanced operation and to define the reference impedances the differential and common mode.

Depending on the test setup, the analyzer provides different types of mixed mode parameters; refer to the following sections for details.

### 3.3.5.2 Mixed Mode Parameters

Mixed mode parameters are an extension of normal mode parameters (e.g. S-parameters, impedances and admittances) for balanced measurements. The analyzer can measure mixed mode parameters as soon as a balanced port configuration is selected.

Mixed mode parameters are used to distinguish the following three port modes:

- s: Single-ended (for unbalanced ports)
- d: Differential mode (for balanced ports)
- c: Common mode (for balanced ports)

The notation of a general S-parameter is  $S_{<out><min><out><in>}$ , where <out> and <min> denote the output and input port modes, <out> and <in> denote the output and input port numbers.

#### Meaning of 2-port mixed mode S-parameters

The mixed mode 2-port S-parameters can be interpreted as follows:

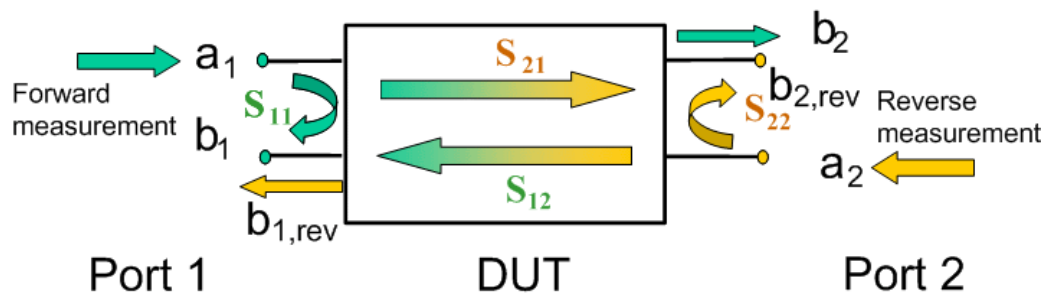

- $S_{<out><min>11}$  is the mixed mode input reflection coefficient, defined as the ratio of the wave quantities  $b_1$  (mode mout) to  $a_1$  (mode min), measured at PORT 1 (forward measurement with matched output and  $a_2 = 0$ ).
- $S_{<out><min>21}$  is the mixed mode forward transmission coefficient, defined as the ratio of the wave quantities  $b_2$  (mode mout) to  $a_1$  (mode min) (forward measurement with matched output and  $a_2 = 0$ ).
- $S_{<out><min>12}$  is the mixed mode reverse transmission coefficient, defined as the ratio of the wave quantities  $b_1$  (mode mout) (reverse measurement with matched input,  $b_1'$  in the figure above and  $a_1 = 0$ ) to  $a_2$  (mode min).
- $S_{<out><min>22}$  is the mixed mode output reflection coefficient, defined as the ratio of the wave quantities  $b_2$  (mode mout) (reverse measurement with matched input,  $b_2'$  in the figure above and  $a_1 = 0$ ) to  $a_2$  (mode min), measured at PORT 2.

If  $<out>$  is different from  $<min>$ , the S-parameters are called mode conversion factors.

**Mixed Mode Parameters for Different Test Setups**

Which types of mixed mode parameter are available depends on the measured device and the port configuration of the analyzer. The following examples of mixed mode parameters can all be obtained with a 2-port analyzer.

1. DUT with only single-ended ports: No balanced port definition necessary, the analyzer provides single-ended multiport parameters.
2. DUT with one balanced port: Only reflection and mode conversion measurements with differential and common mode parameters.

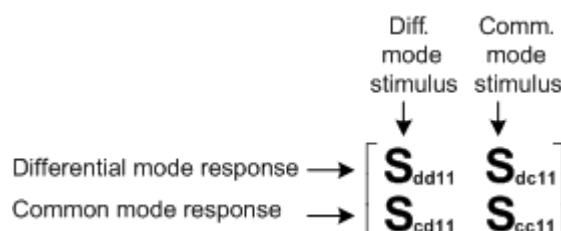

### 3.3.6 Reference Impedances

Changing the reference impedances of the analyzer ports is often referred to as renormalization of port impedances. Renormalization means that the measurement results measured at 50 Ω (75 Ω) are converted into results at arbitrary port impedance.

- Renormalization of the physical port impedances affects e.g. S-parameters and wave quantities in "Power" representation.
- Renormalization of the balanced port impedances affects all measured quantities ("Trace > Measure") that the analyzer provides for balanced ports.

The default reference impedance of a physical port is equal to the reference impedance of the connector type assigned to the port (50 Ω or 75 Ω). It can be defined as a complex value. For balanced ports it is possible to define separate complex reference impedances for differential and for common mode.

The default values for the balanced port reference impedances are derived from the default reference impedance of the physical analyzer ports ( $Z_0 = 50 \Omega$ ):

- The default value for the differential mode is  $Z_{0d} = 100 \Omega = 2 \cdot Z_0$ .
- The default value for the common mode is  $Z_{0c} = 25 \Omega = Z_0/2$

Renormalization can be based on two alternative waveguide circuit theories whose conversion formulas may yield different results if the reference impedance of at least one test port has a non-zero imaginary part.

#### Conversion formula for wave quantities and S-parameters

Renormalization transforms the "raw" S-matrix  $S_0$  for the default reference impedances  $Z_{0i}$  (with physical port number index  $i = 1, 2, \dots, n$ ) into a "renormalized" S-matrix  $S_1$  for the modified reference impedances  $Z_{1i}$ . In terms of raw and renormalized wave quantities  $a_{0i}$ ,  $b_{0i}$  and  $a_{1i}$ ,  $b_{1i}$ ,  $S_0$  and  $S_1$  are defined as follows:

$$\begin{pmatrix} b_{01} \\ b_{02} \\ \dots \\ b_{0n} \end{pmatrix} = S_0 \cdot \begin{pmatrix} a_{01} \\ a_{02} \\ \dots \\ a_{0n} \end{pmatrix}; \quad \begin{pmatrix} b_{11} \\ b_{12} \\ \dots \\ b_{1n} \end{pmatrix} = S_1 \cdot \begin{pmatrix} a_{11} \\ a_{12} \\ \dots \\ a_{1n} \end{pmatrix}.$$

The renormalized wave quantities ( $a_1$  and  $b_1$ ) and the S-matrix  $S_1$  can be calculated from  $S_0$  and the reference impedances  $Z_{0i}$ ,  $Z_{1i}$  according to two alternative waveguide circuit theories.

#### 1. Travelling waves

In the model of Marks and Williams ("A General Waveguide Circuit Theory"), the wave quantities  $a$  and  $b$  are transformed as follows:

$$\begin{pmatrix} a_{1i} \\ b_{1i} \end{pmatrix} = \frac{1}{2Z_{0i}} \left| \frac{Z_{0i}}{Z_{1i}} \right| \sqrt{\frac{\operatorname{Re}(Z_{1i})}{\operatorname{Re}(Z_{0i})}} \cdot \begin{pmatrix} Z_{0i} + Z_{1i} & Z_{0i} - Z_{1i} \\ Z_{0i} - Z_{1i} & Z_{0i} + Z_{1i} \end{pmatrix} \cdot \begin{pmatrix} a_{0i} \\ b_{0i} \end{pmatrix}$$

The renormalized S-matrix  $S_1$  is calculated as

$$S_1 = P^{-1}(S_0 - \gamma)(E - \gamma S_0)^{-1}P$$

with the unit matrix E and two additional matrices with the elements

$$\gamma_{ii} = \frac{Z_{1i} - Z_{0i}}{Z_{1i} + Z_{0i}}$$

$$P_{ii} = \frac{2Z_{0i}}{Z_{0i} + Z_{1i}} \left| \frac{Z_{1i}}{Z_{0i}} \right| \sqrt{\frac{\operatorname{Re}(Z_{0i})}{\operatorname{Re}(Z_{1i})}}$$

## 2. Power waves

In the model of Kurokawa ("Power Waves and the Scattering Matrix"), the wave quantities a and b are transformed as follows:

$$\begin{pmatrix} a_{1i} \\ b_{1i} \end{pmatrix} = \frac{1}{2\sqrt{\operatorname{Re}(Z_{0i})\operatorname{Re}(Z_{1i})}} \cdot \begin{pmatrix} \overline{Z_{0i}} + Z_{1i} & Z_{0i} - Z_{1i} \\ Z_{0i} - Z_{1i} & \overline{Z_{0i}} + Z_{1i} \end{pmatrix} \cdot \begin{pmatrix} a_{0i} \\ b_{0i} \end{pmatrix}$$

The renormalized S-matrix S1 is calculated as

$$S_1 = A^{-1}(S_0 - \bar{\Gamma})(E - \Gamma S_0)^{-1}A$$

with the unit matrix E and two additional matrices with the elements

$$\Gamma_{ii} = \frac{Z_{1i} - Z_{0i}}{Z_{1i} + Z_{0i}}$$

$$A_{ii} = \frac{1 - \bar{\Gamma}_{ii}}{|1 - \Gamma_{ii}|} \sqrt{|1 - \Gamma_{ii}\bar{\Gamma}_{ii}|}$$

### 3.3.7 Stability Factors

The stability factors K,  $\mu_1$  and  $\mu_2$  are real functions of the (complex) S-parameters, defined as follows:

$$K := \frac{1 - |S_{11}|^2 - |S_{22}|^2 + |S_{11} \cdot S_{22} - S_{12} \cdot S_{21}|^2}{2 \cdot |S_{12} \cdot S_{21}|}$$

$$\mu_1 := \frac{1 - |S_{11}|^2}{|S_{22} - \overline{S_{11}} \cdot (S_{11} \cdot S_{22} - S_{12} \cdot S_{21})| + |S_{12} \cdot S_{21}|}$$

$$\mu_2 := \frac{1 - |S_{22}|^2}{|S_{11} - \overline{S_{22}} \cdot (S_{11} \cdot S_{22} - S_{12} \cdot S_{21})| + |S_{12} \cdot S_{21}|}$$

where  $\bar{S}$  denotes the complex conjugate of  $S$ .

Stability factors are calculated as functions of the frequency or another stimulus parameter. They provide criteria for linear stability of two-ports such as amplifiers. A linear circuit is said to be unconditionally stable if no combination of passive source or load can cause the circuit to oscillate.



For a unidirectional R&S ZND (see [Chapter 3.1.4.2, "R&S ZND: Unidirectional vs. Bidirectional Operation"](#), on page 16) stability factors are not available.

- The K-factor provides a necessary condition for unconditional stability: A circuit is unconditionally stable if  $K > 1$  and an additional condition is met. The additional condition can be tested by means of the stability factors  $\mu_1$  and  $\mu_2$ .
- The  $\mu_1$  and  $\mu_2$  factors both provide a necessary and sufficient condition for unconditional stability: The conditions  $\mu_1 > 1$  or  $\mu_2 > 1$  are both equivalent to unconditional stability. This means that  $\mu_1$  and  $\mu_2$  provide direct insight into the degree of stability or potential instability of linear circuits.

References: Marion Lee Edwards and Jeffrey H. Sinsky, "A New Criterion for Linear 2-Port Stability Using a Single Geometrically Derived Parameter", IEEE Trans. MTT, vol. 40, No. 12, pp. 2303-2311, Dec. 1992.

### 3.3.8 Delay, Aperture, Electrical Length

The group delay  $\tau_g$  represents the propagation time of wave through a device.  $\tau_g$  is a real quantity and is calculated as the negative of the derivative of its phase response. A non-dispersive DUT shows a linear phase response, which produces a constant delay (a constant ratio of phase difference to frequency difference).

The group delay is defined as:

$$\tau_g = -\frac{d\phi_{rad}}{d\omega} = -\frac{d\phi_{deg}}{360^\circ df}$$

where

$\Phi_{rad}$ ,  $\Phi_{deg}$  = phase response in radians or degrees

$\omega$  = angular velocity in radians/s

$f$  = frequency in Hz

In practice, the analyzer calculates an approximation to the derivative of the phase response, taking a small frequency interval  $\Delta f$  and determining the corresponding phase change  $\Delta\Phi$ . The delay is thus computed as:

$$\tau_{g,meas} = -\frac{\Delta\phi_{deg}}{360^\circ \cdot \Delta f}$$

The aperture  $\Delta f$  must be adjusted to the conditions of the measurement.

If the delay is constant over the considered frequency range (non-dispersive DUT, e.g. a cable), then  $\tau_g$  and  $\tau_{g,meas}$  are identical and

$$\tau_g = \frac{d(360^\circ f \cdot \Delta t)}{360^\circ d f} = \Delta t = \frac{L_{mech} \cdot \sqrt{\epsilon}}{c}$$

where  $\Delta t$  is the propagation time of the wave across the DUT, which often can be expressed in terms of its mechanical length  $L_{mech}$ , the permittivity  $\epsilon$ , and the velocity of light  $c$ . The product  $L_{mech} \cdot \sqrt{\epsilon}$  is termed the electrical length of the DUT and is always larger or equal than the mechanical length ( $\epsilon > 1$  for all dielectrics and  $\epsilon = 1$  for the vacuum).

## 3.4 Operations on Traces

The R&S ZNC/ZND can perform more complex operations on the measured traces. Some of the operations, e.g. the time domain transform, require additional software options; see [Chapter 3.7, "Optional Extensions and Accessories"](#), on page 109.

The R&S ZNC/ZND can also check whether the measured values comply with specified limits and export trace data, using different file formats.

### 3.4.1 Limit Check

A limit line is a set of data to specify the allowed range for some or all points of a trace. Typically, limit lines are used to check whether a DUT conforms to the rated specifications (conformance testing).

- The "upper" limit line defines the maximum value for the trace points.
- The "lower" limit line defines the minimum value for the trace points.
- The "ripple" limit defines the maximum difference between the largest and the smallest response value of the trace. A ripple limit test is suitable e.g. to check whether the passband ripple of a filter is within acceptable limits, irrespective of the actual transmitted power in the passband.
- The "circle" limit defines the acceptable values as a circular area within a polar diagram.

A limit check consists of comparing the measurement results to the limit lines and display a pass/fail indication. An acoustic warning and a TTL signal at the "USER PORT" on the rear panel (for test automatization) can be generated in addition if a limit is exceeded.

Upper and lower limit lines are both defined as a combination of segments with a linear dependence between the measured quantity and the sweep variable (stimulus variable). Similar to this segmentation, ripple limits may be defined in several ranges. The limit lines (except circle limits) can be stored to a file and recalled. Data or memory traces can be used to define the segments of an upper or lower limit line. Moreover it is

possible to modify the upper and lower limit lines globally by adding an offset to the stimulus or response values.

### 3.4.1.1 Rules for Limit Line Definition

The analyzer places very few restrictions on the definition of limit line segments.

The following rules ensure a maximum of flexibility:

- Segments do not have to be sorted in ascending or descending order (e.g. the "Start Stimulus" value of segment no.  $n$  doesn't have to be smaller than the "Start Stimulus" value of segment no.  $n+1$ ).
- Overlapping segments are allowed. The limit check in the overlapping area is related to the tighter limit (the pass test involves a logical AND operation).
- Gaps between segments are allowed and equivalent to switching off an intermediate limit line segment.
- Limit lines can be partially or entirely outside the sweep range, however, the limits are only checked at the measurement points.

The following figure shows a limit line consisting of 3 upper and 2 lower limit line segments. To pass the limit check, the trace must be confined to the shaded area.

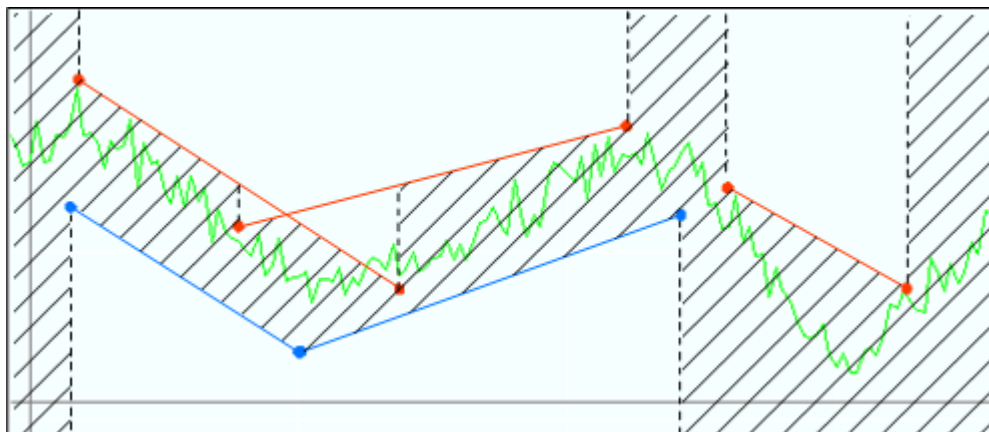

As a consequence of the limit line rules, a DUT will always pass the limit check if no limit lines are defined.

When the sweep axis is changed from linear frequency sweep to logarithmic sweeps, straight limit lines are transformed into exponential curves. The sweep points are re-distributed along the x-axis, so the number of failed points may change.



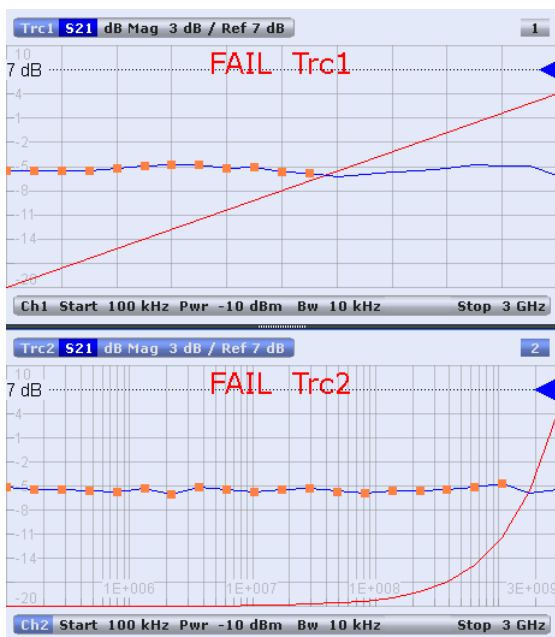

While "Show Limit Line" is active, the diagrams display all limit line segments.

**Exception:** In a segmented frequency sweep with point-based x-axis, gaps between the segments are minimized. To facilitate the interpretation, the R&S ZNC/ZND displays only the limit line segments which provides the limit check criterion (the "tighter" limit line at each point). In the example below, this rule results in a single, continuous lower limit line.

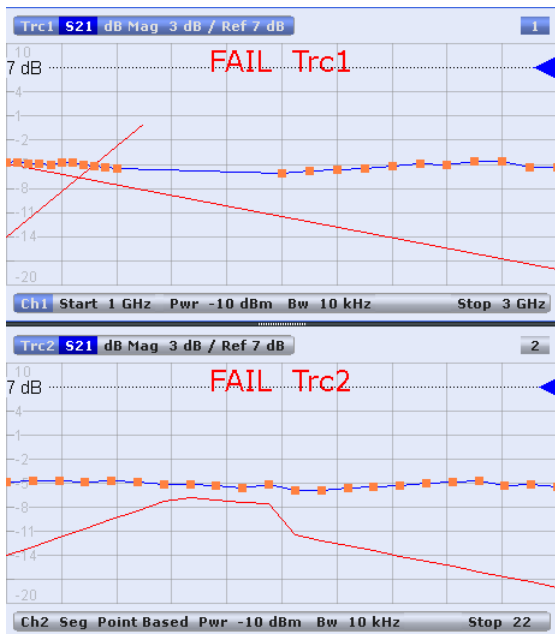

### 3.4.1.2 Rules for Ripple Test Definition

The analyzer places very few restrictions on the definition of ripple limit ranges.

The following rules ensure a maximum of flexibility:

- Ranges do not have to be sorted in ascending or descending order (e.g. the "Start Stimulus" value of range no. n doesn't have to be smaller than the "Start Stimulus" value of range no. n+1).
- Overlapping ranges are allowed. The limit check in the overlapping area is related to the tighter limit (the pass test involves a logical AND operation).
- Gaps between ranges are allowed and equivalent to switching off an intermediate ripple limit range.
- Ripple limit ranges can be partially or entirely outside the sweep range, however, the limits are only checked at the measurement points.

The following figure shows a ripple limit test involving 3 active ranges.

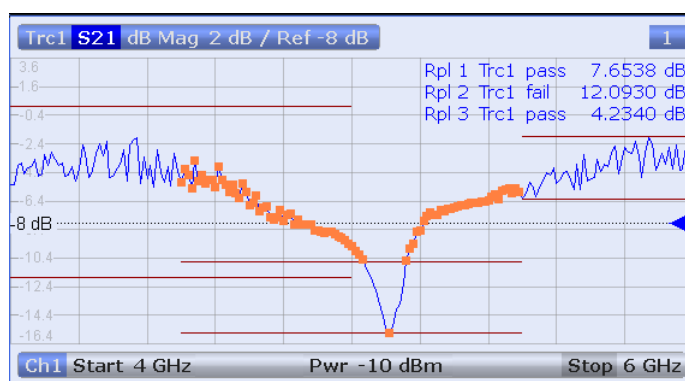

The limit line rules for logarithmic sweeps and segmented frequency sweeps with point based x-axis also apply to ripple limit lines (see [Chapter 3.4.1.1, "Rules for Limit Line Definition"](#), on page 64).

### 3.4.1.3 Circle Limits

A circle limit is a special type of **upper** limit line which is defined by its center coordinate in the diagram and its radius. Depending on the diagram type, circle limit can serve different purposes:

- With a circle limit line centered around the origin of a polar diagram, you can check whether the magnitude of the measurement results exceeds a limit, defined by the radius of the limit line.

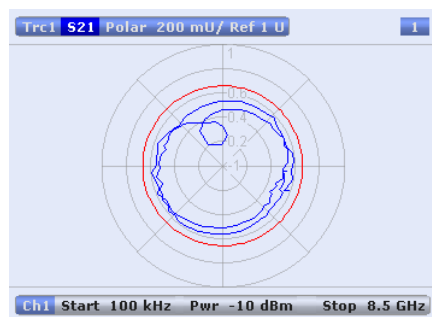

- With a circle limit line adjusted to the right border of a Smith diagram ( $Z = \text{infinity}$ ), you can check whether the imaginary part of the impedance ( $\text{Im}(Z)$ , reactance) falls below a limit.

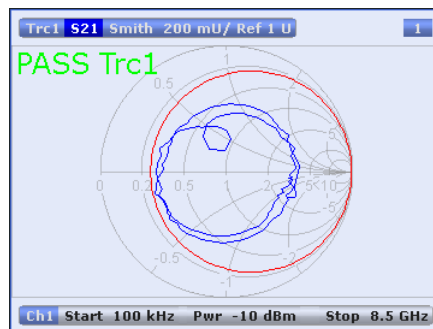

- With a circle limit line centered around the left border of an inverted Smith diagram ( $Y = \text{infinity}$ ), you can check whether the imaginary part of the admittance ( $\text{Im}(Y)$ , susceptance) falls below a limit.

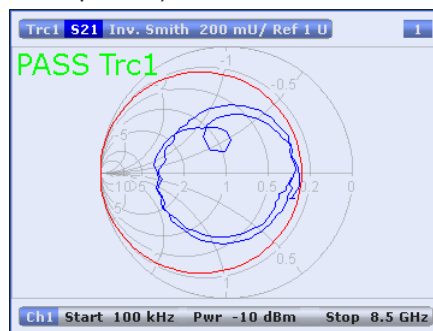

### 3.4.1.4 File Format for Limit Lines

The analyzer uses a simple ASCII format to export limit line data. By default, the limit line file has the extension \*.limit and is stored in the directory shown in the "Export Limit Line" and "Import Limit Line" dialogs. The file starts with a preamble containing the channel and trace name and the header of the segment list. The following lines contain the entries of all editable columns of the list.

#### Example of a limit line file

The limit line:

	Type	Start Stimulus	Stop Stimulus	Start Response	Stop Response
1	Upper	9 kHz	8.5 GHz	0 dB	0 dB
2	Lower	9 kHz	6 GHz	-20 dB	-10 dB
3	Off	6 GHz	8.5 GHz	-10 dB	-10 dB

is described by the limit line file:

```
# Version 1.00
#
# Channel 1
# Trace 1
en:Type,Start Stimulus[MHz],Stop Stimulus[MHz],Start Response[dB],Stop Response[dB],
Upper,8.999999999999999E-003,8.500000000000000E+003,0.000000000000000E+000,0.000000000000000E+000,
Lower,8.999999999999999E-003,6.000000000000000E+003,-2.000000000000000E+001,-1.000000000000000E+001,
Off,6.000000000000000E+003,8.500000000000000E+003,-1.000000000000000E+001,-1.000000000000000E+001,
```



### Compatibility with other instruments

Network analyzers of the R&S ZVA/ZVB family use the same file format. Limit line files can be interchanged without restriction.

#### 3.4.1.5 File Format for Ripple Limits

The analyzer uses a simple ASCII format to export ripple limit data. By default, the ripple limit file has the extension `*.ripple` and is stored in the directory shown in the "Save Ripple Limits" and "Recall Ripple Limits" dialogs. The file starts with a preamble containing the channel and trace name and the header of the range list. The following lines contain the entries of all editable columns of the list.

#### Example of a ripple limit file

The ripple limit list:

	Range On/Off ^	Start Stimulus	Stop Stimulus	Ripple Limit
1	<input checked="" type="checkbox"/>	3 GHz	5 GHz	12 dB
2	<input checked="" type="checkbox"/>	4.5 GHz	5.5 GHz	5 dB
3	<input type="checkbox"/>	5.5 GHz	6 GHz	4.3826 dB

is described by the ripple limit file:

```
# Version 1.00
#
# Channel 1
# Trace 1
bo:Range on/off,start stimulus[MHz],stop stimulus[MHz],Ripple Limit[dB],
true,3.000000000000000E+003,5.000000000000000E+003,1.200000000000000E+001,
true,4.500000000000000E+003,5.500000000000000E+003,5.000000000000000E+000,
false,5.500000000000000E+003,6.000000000000000E+003,4.382581058243317E+000,
```



### Compatibility with other instruments

Network analyzers of the R&S ZVA/ZVB family use the same file format. Ripple limit files can be interchanged without restriction.

#### 3.4.2 Trace Files

The R&S ZNC/ZND can store one or several data or memory traces to a file or load a memory trace from a file.

Trace files are ASCII files with selectable file format. The analyzer provides several types of trace files:

- Touchstone (`*.s<n>p`) files
- ASCII (`"*.csv"`) files
- Matlab (`"*.dat"`) files are ASCII files which can be imported and processed in Matlab.

The trace file formats complement each other; see [Chapter 3.4.2.3, "Finding the Best File Format"](#), on page 72.



When exporting traces to a file, it is recommended to set the analyzer to single sweep mode ("CHANNEL > SWEEP > Sweep Control > All Channels on Hold"). This will ensure that a complete sweep is exported.

### 3.4.2.1 Touchstone Files

Touchstone files contain a header, a comment section, and the actual trace data:

```
# HZ S RI R 50.00
! Rohde & Schwarz Vector Network Analyzer
! Rohde-Schwarz, ZNC3-2Port, 1311601044100005, 1.93.1.42
! Created: UTC 9/17/2013, 9:13:56 AM
! freq[Hz] re:S11 im:S11
1.0000000000000000E5 -4.897128641605377E-1 3.767784312367439E-2
4.2599500000000000E7 -5.450598597526550E-1 3.608805686235428E-2
...
```

# indicates the beginning of the header line (required at the top of file), which consists of the following data elements:

- <Frequency unit>: HZ / KHZ / MHZ / GHZ allowed for imported files; the analyzer always uses HZ for exported data.
- <Data file type>: at present only S for S-parameter files is supported
- <Data format>: RI for Re/Im, MA for linear Mag-Phase, DB for Mag-Phase in decibels; the data format for export files can be selected in the Export Data dialog.
- <Reference resistance>: specifies the impedance system underlying the trace data, given as a real, positive resistance (default 50 Ω)

Comment lines start with the exclamation mark (!) and may contain any text used for documentation of the trace data file. Any number of comment lines may be inserted before or after the header line.

The following information is displayed in the comments section:

- VNA identification (comment line 2 in above example)
- timestamp (comment line 3)
- port-specific renormalization information (comment lines 4ff, if applied; see [Example "Renormalization comments"](#) on page 71)
- headings for included data tables (comment lines right above the data tables, starting with ! freq)

The trace data section corresponds to a set of single-ended S-parameters. It depends on the number of ports and the data format. For real and imaginary values (<Data format> = RI) the trace data for each stimulus frequency is arranged as indicated in the lowermost comment lines during export:

#### 1-port files (\*.s1p)

```
! freq[Hz] re:S11 im:S11
```

$S_{11}$  can be replaced by any S-parameter, so the \*.s1p format is suitable for exporting an arbitrary data trace representing an S-parameter.

### 2-port files (\*.s2p)

```
! freq[Hz] re:S11 im:S11 re:S21 im:S21 re:S12 im:S12 re:S22 im:S22
```

(all values arranged in 1 line)

The stimulus frequencies are arranged in ascending order. If a "lin. Mag-Phase (MA)" or "dB Mag-Phase (DB)" data format is selected, the real and imaginary S-parameter values `re:Sij` `im:Sij` are replaced by `mag:Sij` `ang:Sij` or `db:Sij` `ang:Sij`, respectively.

The entries in the data lines are separated by white space, and a data line is terminated by a new line character.

### Conditions for Touchstone file export

- One-port Touchstone files with data from a single trace  
Touchstone files are normally intended for a complete set of <n>-port S-parameters. The only exceptions are one-port Touchstone files that can be created using an arbitrary trace. This type of export can be accessed using either the GUI function "TRACE > TRACE CONFIG > Trace Data > s1p Active Trace..." or the remote command `MMEMoRY:STORe:TRACe`.

The following restrictions apply to this export type:

- the reference resistance of the Touchstone option line is fixed to 50 Ω - regardless of the reference impedance setting of the involved port
- the data file type of the Touchstone option line is fixed to S (for S-parameter) although the trace may represent a different parameter type
- Touchstone files containing S-parameters
  - For a one-port Touchstone file, the reflection coefficient for the specified port ( $S_{ii}$  for port i) must be measured. If a full one-port (Refl OSM) or a full n-port (TOSM, TNA, TRL ...) calibration is available for the specified port, it is possible to export the data even when the trace is not displayed.
  - For a multiport Touchstone file \*.s<n>p, either a full multiport system error correction or a complete set of  $n^2$  S-parameters must be available. If the port configuration contains balanced ports, the exported Touchstone file contains the converted single-ended S-parameters.  
This type of export can be initiated from the GUI by using the "s<n>p Port ..." or "snp Free Config. ..." functions of the "TRACE > TRACE CONFIG > Trace Data" softtool or by the remote command `MMEMoRY:STORe:TRACe:PORTs`



For a unidirectional R&S ZND (see [Chapter 3.1.4.2, "R&S ZND: Unidirectional vs. Bidirectional Operation"](#), on page 16) the S-parameters  $S_{12}$  cannot be measured and hence an export to \*.s2p file is not available. However, you may *import* S-parameter traces from arbitrary \*.snp files.

### Renormalization of S-parameters

Renormalization means that the S-parameters at connector impedances are converted into S-parameters at certain target impedances. During export the S-parameters can be renormalized in two ways: either a common target impedance is used for all ports or the individual port reference impedances are used.

If the reference impedances are identical and real this common resistance value is used as reference resistance of the Touchstone option line. Otherwise the value 50  $\Omega$  is used.

- **Common Target Impedance**  
For multi-port S-parameters the reference resistance of the Touchstone option line is taken as common target impedance and the data is renormalized to the common target impedance, regardless of the port reference impedances. Thus in case of ambiguous port reference impedances the data is always renormalized to 50  $\Omega$ .

- **Port Reference Impedance**  
The [Chapter 3.3.6, "Reference Impedances"](#), on page 60 of the individual ports are used as target impedances for the renormalization. The target impedances are listed in a comment line in the Touchstone file; if the related ports use different reference impedances, an additional comment with a warning is added that the Touchstone option line contains a non-matching reference resistance (see example below).

**Note** that when re-importing this type of file into standard applications (including the R&S ZNC/ZND itself), the reference resistance from the Touchstone option line is used and the impedance system underlying the data will not be interpreted correctly.

#### Example: Renormalization comments

```
!The following Port Impedance Renormalization has been used when saving the data.
!PortZ Port1:50+j0 Port2:70+j0
!Note: The Port Impedances differ from the reference impedance of this file.
! While reading the file the reference impedance value of the option line above
! is always used.
```



Touchstone files cannot be used to export mathematical traces.

#### 3.4.2.2 ASCII (\*.csv) Files

An ASCII file contains a header and the actual trace data:

```
freq;reTrc1_S21;imTrc1_S21;reMem2[Trc1_S21;imMem2[Trc1_S21;
300000.000000;0.000000;0.000000;0.000000;0.000000;
40499497.487437;0.000000;0.000000;0.000000;0.000000;
80698994.974874;0.494927;-0.065174;0.500833;-0.074866;
120898492.462312;0.497959;-0.111724;0.488029;-0.107375;
```

...

The header consists of the following data elements:

- <Stimulus> stimulus variable: freq for Frequency sweep, power for Power sweep, time for Time sweep, trigger for CW Mode sweep.
- <reTrace1> first response value of first trace: re<Trace\_Name>, mag<Trace\_Name> or db<Trace\_Name> for output format Re/Im, lin. Mag-Phase or dB Mag-Phase, respectively. The data format for export files can be selected in the Export Data dialog.
- <imTrace1> second response value of first trace: im<Trace\_Name> for output format Re/Im, ang<Trace\_Name> for output formats lin. Mag-Phase or dB Mag-Phase. The data format for export files can be selected in the Export Data dialog.
- <reTrace2> first response value of second trace: re<Trace\_Name>, mag<Trace\_Name> or db<Trace\_Name> for output format Re/Im, lin. Mag-Phase or dB Mag-Phase, respectively. The data format for export files can be selected in the Export Data dialog.
- <imTrace2>... second response value of second trace: im<Trace\_Name> for output format Re/Im, ang<Trace\_Name> for output formats lin. Mag-Phase or dB Mag-Phase. The data format for export files can be selected in the Export Data dialog. first response value of second trace. HZ / KHZ / MHZ / GHZ allowed for imported files. The analyzer always uses HZ for exported data. second response value of first trace: im<Trace\_Name> for output format Re/Im, ang<Trace\_Name> for output formats lin. Mag-Phase or dB Mag-Phase. The data format for export files can be selected in the Export Data dialog.

The trace data is arranged as described in the header. Different values are separated by semicolons, commas or other characters, depending on the selected "Decimal Separator" in the "Export ... Data" dialogs. A semicolon is inserted before the end of each line.

The stimulus values are arranged in ascending order.

### 3.4.2.3 Finding the Best File Format

The file format depends on how you want to use the exported data.

Use a **Touchstone** file format to export single-ended S-parameter data traces to a file that can be evaluated with applications such as Agilent's Microwave Design System (MDS) and Advanced Design System (ADS), and to convert mixed mode parameters back to single-ended parameters. The data must be acquired in a frequency sweep. Note the "[Conditions for Touchstone file export](#)" on page 70.

Use the **ASCII (\*.csv)** format if you want to do one of the following:

- Import the created file into a spreadsheet application such as Microsoft Excel.
- Export an arbitrary number of traces, multiple traces with the same parameter or memory traces.
- Export traces acquired in a power sweep or CW sweep.
- Use export options.



Use a the **Matlab (\*.dat)** format if you want to import and process the trace data in Matlab.

## 3.5 Calibration

Calibration or "system error correction" is the process of eliminating systematic, reproducible errors from the measurement results (S-parameters and derived quantities; see [Chapter 3.1.5, "Data Flow"](#), on page 18). The process involves the following stages:

1. A set of calibration standards is selected and measured over the required sweep range. For many calibration types the magnitude and phase response of each calibration standard (i.e. its S-parameters if no system errors occur) must be known within the entire sweep range. In some calibration procedures (TRL, TNA, TRM), part of the characteristics of the standards can be auto-determined due to implicit redundancy (self-calibration).
2. The analyzer compares the measurement data of the standards with their known, ideal response. The difference is used to calculate the system errors using a particular error model (calibration type) and derive a set of system error correction data.
3. The system error correction data is used to correct the measurement results of a DUT that is measured instead of the standards.

Calibration is always channel-specific because it depends on the hardware settings, in particular on the sweep range. This means that a system error correction data set is stored with the calibrated channel.

The analyzer provides a wide range of sophisticated calibration methods for all types of measurements. Which calibration method is selected depends on the expected system errors, the accuracy requirements of the measurement, on the test setup and on the types of calibration standards available.

Due to the analyzer's calibration wizard, calibration is a straightforward, menu-guided process. Moreover, it is possible to perform the entire calibration process automatically using a Calibration Unit (e.g. R&S ZN-Z5x or R&S ZN-Z15x).



The system error correction data determined in a calibration procedure are stored on the analyzer. You can read these correction data using the remote control command `[SENSe<Ch>:]CORRection:CDATa`. You can also replace the correction data of the analyzer by your own correction data sets.

---



### Cal Off label

A label "Cal Off" appears in the trace line if the system error correction no longer applies to the trace:

Trc2 S21 dB Mag 10 dB/ Ref 0 dB Cal Off

This may happen for one of the following reasons:

- The sweep range is outside the calibrated frequency range.
- The measurement result is a wave quantity or ratio which is never system error corrected (see [Chapter 3.1.5, "Data Flow"](#), on page 18).
- The channel calibration is not sufficient for the measured quantity (e.g. a one-port calibration has been performed, but the measured quantity is a transmission parameter).
- The system error correction has been switched off deliberately ("User Cal Active" is disabled).

The analyzer provides other labels to indicate the status of the current calibration; see [Chapter 3.5.4, "Calibration Labels"](#), on page 91.



### Calibration and port de-/activation

The way the analyzer firmware activates/deactivates ports after a successful calibration (system error correction or power calibration) has slightly changed:

- In all FW releases, calibrated ports that were previously disabled, are automatically enabled as single-ended logical ports.
- Starting with FW version 2.10, uncalibrated ports were disabled in the related channel(s). If only one of the physical ports forming a balanced port was calibrated, the balanced port was dissolved and only the uncalibrated (single-ended) port was disabled.  
In earlier FW versions there was no such port deactivation mechanism.
- Since FW version 2.40 an uncalibrated port is only disabled if it is not used by a measurement, i.e. if it is not required by any trace of the related channel.

## 3.5.1 Calibration Types

The analyzer provides a wide range of calibration types for one, two or more ports. The calibration types differ in the number and types of standards used, the error terms, i.e. the type of systematic errors corrected and the general accuracy. The following table gives an overview.

Table 3-4: Overview of calibration types

Calibration Type	Standards	Parameters	Error Terms	General Accuracy	Application
Reflection Normalization	Open or Short	$S_{11}$ (or $S_{22}, \dots$ )	Reflection tracking	Low to medium	Reflection measurements on any port.
Transmission Normalization	Through	$S_{12}, S_{21}$ (or $S_{13}, \dots$ )	Transmission tracking	Medium	Transmission measurements in any direction and between any combination of ports.
Reflection OSM	Open, Short, Match <sup>1)</sup>	$S_{11}$ (or $S_{22}, \dots$ )	Reflection tracking, Source match Directivity,	High	Reflection measurements on any port.
One Path Two Ports	Open, Short, Match <sup>1)</sup> (at source port), Through <sup>2)</sup> between the source port and all target ports	$S_{11}, S_{21}$ (or $S_{22}, \dots$ )	Reflection tracking, Source match, Directivity, Transmission tracking	Medium to high	Unidirectional transmission measurements in any direction and between any combination of ports.
TOSM or UOSM (2-port)	Open, Short, Match <sup>1)</sup> (at each port), Through <sup>2)</sup> (between all port pairs)	All	Reflection tracking, Source match, Directivity, Load match, Transmission tracking,	High	Reflection and transmission measurements; classical 12-term error correction model.
Adapter Removal (2-port)	Open, Short, Match <sup>1)</sup> (at each port), Through	All Reflection parameters with and without adapter	Reflection tracking, Source match, Directivity, Load match, Transmission tracking,	High	Reflection and transmission measurements; classical 12-term error correction model.
TOM (2-port)	Open, Match (at both ports), Through (between all port pairs)	All	Reflection tracking, Source match, Directivity, Load match, Transmission tracking	High	Reflection and transmission measurements.
TSM (2-port)	Short, Match (at both ports), Through (between all port pairs)	All	Reflection tracking, Source match, Directivity, Load match, Transmission tracking	High	Reflection and transmission measurements.

Calibration Type	Standards	Parameters	Error Terms	General Accuracy	Application
TRM (2-port)	Reflect (equal at both ports), Match, Through (between all port pairs)	All	Reflection tracking, Source match, Directivity, Load match, Transmission tracking	High	Reflection and transmission measurements, especially in test fixtures.
TRL (2-port)	Reflect (at both ports), Through, Line1, other Lines (optional), combination with TRM (optional)	All	Reflection tracking, Source match, Directivity, Load match, Transmission tracking	High, high directivity	Reflection and transmission measurements, especially for planar circuits. Limited bandwidth.
TNA (2-port)	Through, Attenuation, Symmetric network	All	Reflection tracking, Source match, Directivity, Load match, Transmission tracking	High, lowest requirements on standards	Reflection and transmission measurements, especially for planar circuits.

<sup>1)</sup> Or any other 3 known one-port standards. To be used in a guided calibration, the known standards must be declared to be Open, Short, and Match irrespective of their properties.

<sup>2)</sup> Or any other known two-port standard. To be used in a guided calibration, the known standard must be declared to be Through, irrespective of its properties.



For a unidirectional R&S ZND (see [Chapter 3.1.4.2, "R&S ZND: Unidirectional vs. Bidirectional Operation"](#), on page 16) the "bidirectional calibrations" (TOSM and the following) are not available.



The calibration type must be selected in accordance with the test setup. Select the calibration type for which you can obtain or design the most accurate standards and for which you can measure the required parameters with best accuracy.

### 3.5.1.1 Normalization (Refl Norm..., Trans Norm...)

A normalization is the simplest calibration type since it requires the measurement of only one standard for each calibrated S-parameter:

- One-port (reflection) S-parameters ( $S_{11}$ ,  $S_{22}$ , ...) are calibrated with an Open or a Short standard providing the reflection tracking error term.
- Two-port (transmission) S-parameters ( $S_{12}$ ,  $S_{21}$ , ...) are calibrated with a Through standard providing the transmission tracking error term.

Normalization means that the measured S-parameter at each sweep point is divided by the corresponding S-parameter of the standard. A normalization eliminates the frequency-dependent attenuation and phase shift in the measurement path (reflection or

transmission tracking error). It does not compensate for directivity or mismatch errors. This limits the accuracy of a normalization.



Manual transmission normalizations support [Complementary Isolation Measurement](#) (optional).

### 3.5.1.2 Reflection OSM Calibration

A reflection OSM (full one-port) calibration requires a Short, an Open and a Match standard to be connected to a single test port. The three standard measurements are used to derive all three reflection error terms:

- The Short and Open standards are used to derive the source match and the reflection tracking error terms.
- The Match standard is used to derive the directivity error.

A reflection OSM calibration is more accurate than a normalization but is only applicable for reflection measurements.

### 3.5.1.3 One Path Two Ports Calibration

A one path two ports calibration combines a reflection OSM (full one-port) calibration with a transmission normalization. The fully calibrated port is termed the node port. This calibration type requires a Short, an Open and a Match standard to be connected to a single test port plus a Through standard between this calibrated source port and the other load ports. The four standard measurements are used to derive the following error terms:

- The Short and Open standards are used to derive the source match and the reflection tracking error terms at the source port.
- The Match standard is used to derive the directivity error at the source port.
- The Through standard provides the transmission tracking error terms.

For calibration of two ports, a one-path two-port calibration requires only four standards to be connected (instead of 7 for a full two-port TOSM calibration). It is suitable when only the forward (e.g.  $S_{11}$  and  $S_{21}$ ) or reverse S-parameters (e.g.  $S_{22}$  and  $S_{12}$ ) are needed, and if the DUT is well matched, especially at the load port. It is also the best calibration method for test setups with unidirectional signal flow, e.g. a pulsed measurement using an external generator.



For a unidirectional R&S ZND (see [Chapter 3.1.4.2, "R&S ZND: Unidirectional vs. Bidirectional Operation"](#), on page 16) only the forward direction (source port 1) is available.

### 3.5.1.4 TOSM and UOSM Calibration

#### TOSM

A TOSM (Through – Open – Short – Match) calibration requires the same standards as the one path two ports calibration, however, all measurements are performed in the forward and reverse direction. TOSM is also referred to as SOLT (Short – Open – Load = Match – Through) calibration. The four standards are used to derive 6 error terms for each signal direction:

- In addition to the source match and reflection tracking error terms provided by the one-path two-port calibration, TOSM also provides the load match.
- The directivity error is determined at all source ports.
- The transmission tracking is determined for each direction.

TOSM calibration is provided for 2-port measurements. A 2-port TOSM calibration requires 7 standard measurements (3 one-port standards at each port and a Through between the two ports). The Through must be measured in both directions, so the number of standard measurements (calibration sweeps) is 8. The calibration provides 10 error terms (no isolation terms are available).



For a unidirectional R&S ZND (see [Chapter 3.1.4.2, "R&S ZND: Unidirectional vs. Bidirectional Operation"](#), on page 16) neither TOSM nor UOSM calibration is available.



Manual TOSM calibration supports [Complementary Isolation Measurement](#) (optional).

#### UOSM: TOSM with unknown Through

The analyzer can perform a TOSM calibration with any 2-port network serving as through connection, provided that it fulfills the reciprocity condition  $S_{21} = S_{12}$ . The modified TOSM calibration is referred to as UOSM (Unknown through – Open – Short – Match) calibration. It can be selected as follows:

- If different connector types are assigned to the test ports, the analyzer automatically replaces TOSM by UOSM.  
[The network analyzer supports different connector types at its test ports in order to measure DUTs with different port connectors; see also [Chapter 3.5.1.5, "Adapter Removal"](#), on page 79. ]
- If the same connector types are used but an appropriate Through standard is not defined, the analyzer also replaces TOSM by UOSM.
- UOSM can be selected explicitly in the "Calibration Presetting" dialog.

After acquiring the calibration sweep data for the unknown through, the analyzer automatically determines its delay time/transmission phase.

### 3.5.1.5 Adapter Removal

Many DUTs use different connector types on their RF ports (e.g. port 1: N-type connector, female; port 2: PC 3.5-type connector, female).



DUTs of this sort are also known as **noninsertable devices**.

A suitable calibration kit is then required for each of the different connector types. The kit must include, as a minimum, the standards that are used for one-port calibration. The through-connection between test ports with different connector types must be made using **adapters**.

The problem here is that unlike Through standards, adapters are usually not characterized, i.e. their delay time/transmission phase is unknown.

If the adapter fulfills the reciprocity condition  $S_{21} = S_{12}$ , it can serve as **Unknown** through in an **UOSM** calibration (see "**UOSM: TOSM with unknown Through**" on page 78).

**Adapter Removal** is an extension of the **2-port** UOSM calibration. It requires two additional reflection OSM calibrations with the adapter successively connected to port 1 and port 2.

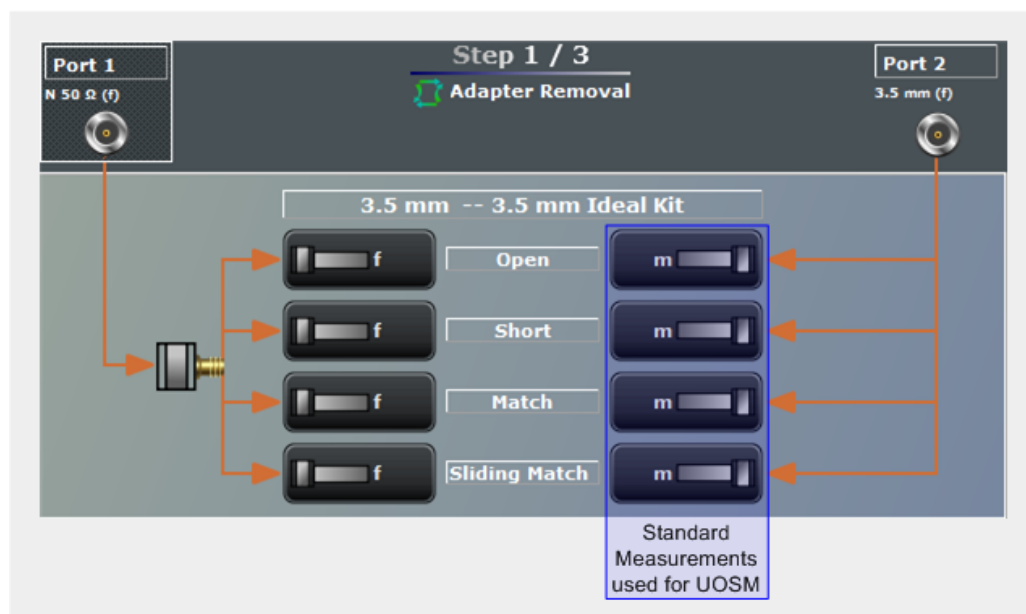

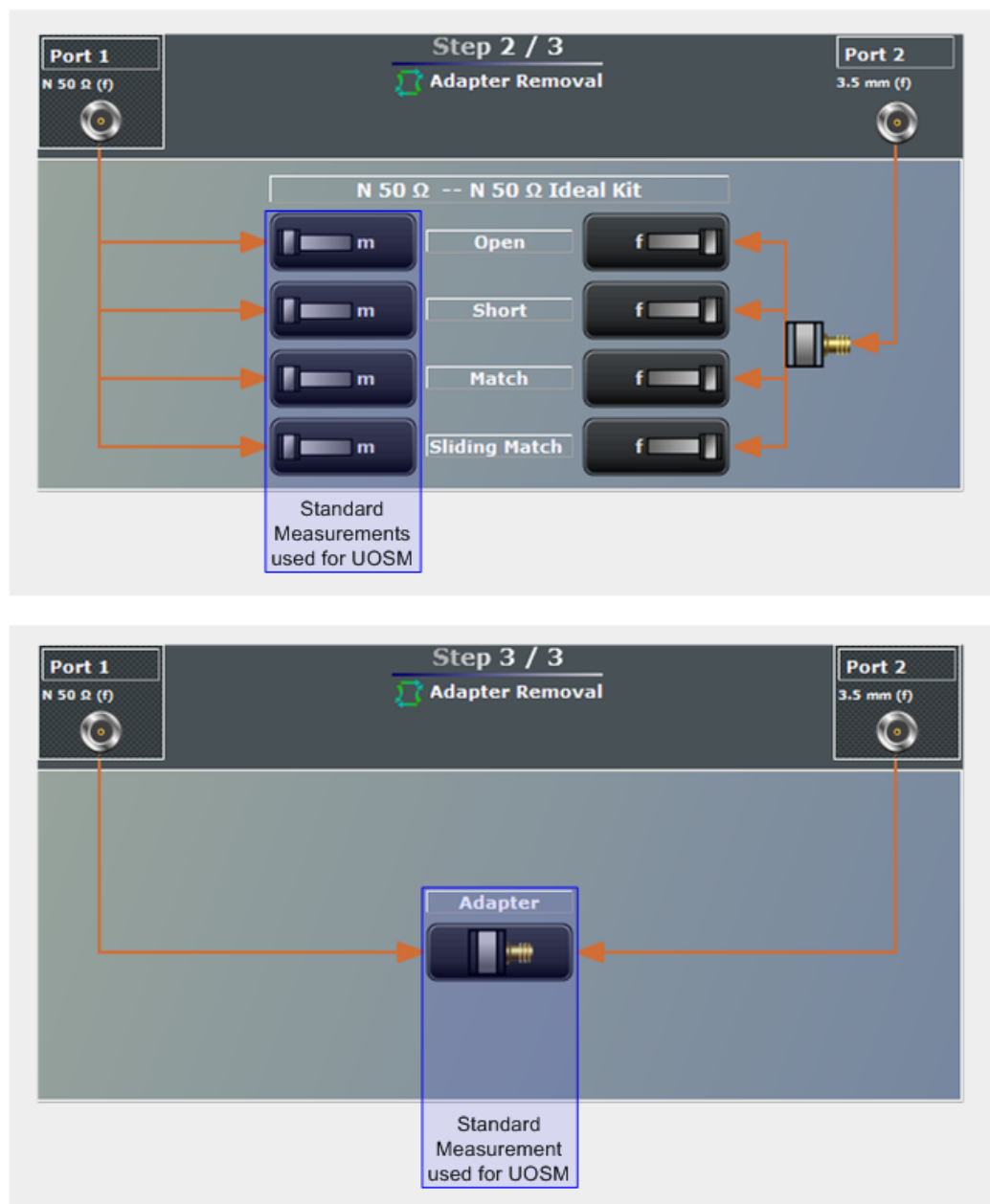

Figure 3-2: Adapter Removal vs. UOSM

The obtained adapter characteristics are mathematically removed from the obtained error coefficients. Uncertainties arising from a non-ideal characterization of the unknown through almost cancel, whereas they add up in the UOSM technique. As a consequence, Adapter Removal will provide more accurate results.



- For a unidirectional R&S ZND (see [Chapter 3.1.4.2, "R&S ZND: Unidirectional vs. Bidirectional Operation"](#), on page 16) Adapter Removal is not available.
- Currently Adapter Removal is not supported with [Automatic Calibration](#).



### 3.5.1.6 TOM Calibration

A TOM (Through – Open – Match) calibration requires a low-reflection, low-loss Through standard with an electrical length that may be different from zero, an Open, and a Match. The characteristics of all standards must be fully known; the Match may have non-ideal characteristics.



For a unidirectional R&S ZND (see [Chapter 3.1.4.2, "R&S ZND: Unidirectional vs. Bidirectional Operation"](#), on page 16) TOM calibration is not available.

---

### 3.5.1.7 TSM Calibration

A TSM (Through – Short – Match) calibration requires a low-reflection, low-loss Through standard with an electrical length that may be different from zero, a Short, and a Match. The characteristics of all standards must be fully known; the Match may have non-ideal characteristics.

TSM calibration can replace TOM calibration if no appropriate "Open" standard is available, especially in the high frequency domain.



For a unidirectional R&S ZND (see [Chapter 3.1.4.2, "R&S ZND: Unidirectional vs. Bidirectional Operation"](#), on page 16) TSM calibration is not available.

---

### 3.5.1.8 TRM Calibration

A TRM (Through – Reflect – Match) calibration requires a low-reflection, low-loss Through standard with an electrical length that may be different from zero, a Reflect, and a Match. The magnitude of the reflection coefficient of the Reflect standard can be unknown but must be nonzero; its phase must be roughly known (90 deg). The magnitude and phase of the reflection coefficient must be the same at both test ports.

TRM calibration is especially useful for DUTs in test fixtures.



For a unidirectional R&S ZND (see [Chapter 3.1.4.2, "R&S ZND: Unidirectional vs. Bidirectional Operation"](#), on page 16) TRM calibration is not available.

---

### 3.5.1.9 TRL Calibration

A TRL (Through – Reflect – Line) calibration requires the two-port standards Through and Line, which are both assumed to be ideally matched. Beyond that, the Through must be lossless, and its length must be exactly known. The length of the Line standard must be known approximately.

Furthermore, a reflecting one-port standard (Reflect) is needed. The magnitude of the reflection coefficient of the Reflect standard can be unknown but must be nonzero; its phase must be roughly known (90 deg). The magnitude and phase of the reflection coefficient must be the same at both test ports.

TRL calibration is especially useful for DUTs in planar line technology (e.g. test fixtures, on-wafer measurements) where it is difficult to design and connect accurately modeled Open, Short or Match standards. If TRL is not practicable, TNA may be an alternative.



For a unidirectional R&S ZND (see [Chapter 3.1.4.2, "R&S ZND: Unidirectional vs. Bidirectional Operation"](#), on page 16) TRL calibration is not available.

### TRL with several lines and with TRM

The system of equations solved to derive the error terms is such that singularities occur whenever the length difference  $\Delta L$  between the Through and the Line is an integer multiple of half of the wave length:

$$\Delta L \neq n \frac{\lambda}{2}$$

As a rule, singularities are avoided with sufficient accuracy if the phase shift resulting from the (electric) length difference between the Through and the Line standard is between  $20^\circ$  and  $160^\circ$ . This corresponds to a ratio of 1:8 for the start and stop frequency of the calibrated sweep range.



To shift the calibrated sweep range to smaller or larger frequencies, you can use a longer or shorter Line. To extend the calibrated range, use one of the following methods:

- Perform TRL calibration with two or three different Line standards. With an appropriate length of the Lines, the ratio for the start and stop frequency of the calibrated sweep range can increase to approx. 1:64 (for 2 lines) or 1:512 (for 3 lines).
- In the low-frequency domain where TRL becomes inaccurate, replace TRL by TRM calibration.

The methods can be combined or used separately. The list of measured standards in the "Calibration" dialog for TRL calibration is extended if the calibration kit in use contains the necessary standards:

- A 2-line (3-line) calibration requires two (three) different Lines of matching gender. The lines must be measured between any combination of two ports.
- A TRM extension at low frequencies requires either a Match or a Sliding Match standard. The standard must be measured at each port.

The complete list of measured standards for a two-port calibration is shown below.

- For a **TRL calibration with 1 Line**, the Reflect standard at both ports, the Through, and one Line standard must be measured.
- For a **TRL calibration with 2 Lines**, a second Line standard must be measured in addition.
- For a TRM calibration, The Reflect and Match standards at both ports and the Through must be measured. See also [Chapter 3.5.2.3, "Sliding Match Standards"](#), on page 88.

The TRL calibration is valid as soon as the standards for a "TRL calibration with 1 line" have been measured. The TRL extensions are applied automatically if the necessary standards have been measured.

P1 N 50 Ω (F) N 50 Ω Ideal Kit	P2 N 50 Ω (F) N 50 Ω Ideal Kit	P1 ↔ P2 N 50 Ω (F) N 50 Ω Ideal Kit
M Match (m)	M Match (m)	T Through (mm)
R Reflect (m)	R Reflect (m)	L Line 1 (mm)
Sliding M Pos 1	Sliding M Pos 1	L Line 2 (mm)
Sliding M Pos 2	Sliding M Pos 2	L Line 3 (mm)
Sliding M Pos 3	Sliding M Pos 3	

### Example: TRL calibration with two and three Lines

If several Lines with different lengths are measured, the analyzer automatically divides the calibrated range into segments. The calibration data of the longest line is applied to the lowest segment, the calibration data of the shortest line to the highest segment.

The calibration sweep segments for two Lines with electric lengths  $l_{\text{long}}$  and  $l_{\text{short}}$  ( $l_{\text{long}} > l_{\text{short}}$ ) are obtained as follows (the Through standard is assumed to be of length  $l_{\text{thr}}$ ):

- The longer Line can be used up to a frequency  $f_{\text{long}}$  where its transmission phase is equal to 160 deg. This frequency is equal to " $f_{\text{long}} = 4 * c_0 / [9 * (l_{\text{long}} - l_{\text{thr}})]$ ".
- The shorter Line can be used from a frequency  $f_{\text{short}}$  where its transmission phase is equal to 20 deg. This frequency is equal to " $f_{\text{short}} = c_0 / [18 * (l_{\text{short}} - l_{\text{thr}})]$ ".
- The border between the two frequency segments  $f_{\text{div}}$  is calculated as the geometric mean of  $f_{\text{long}}$  and  $f_{\text{short}}$ , i.e. " $f_{\text{div}} = \text{sqrt}(f_{\text{long}} * f_{\text{short}})$ ".

The formulas are also applied if " $f_{\text{long}} < f_{\text{short}}$ ".

For a TRL calibration using three Lines with different length, the allowed frequency ranges are calculated in an analogous manner in order to obtain three (ideally overlapping) frequency ranges. The borders between two adjacent frequency ranges are calculated as the geometric mean of the frequency limits  $f_{\text{long}}$  and  $f_{\text{short}}$  of the two ranges.



A second or third line in the list does not mean that you have to measure two or three line standards. If the calibrated frequency range is small enough, the calibration is valid as soon as the analyzer has acquired correction data for a single line standard. The Match and Sliding Match standards are not necessary for TRL calibration, however, they must be measured if TRL is combined with TRM calibration.

### Low-frequency extension with TRM

TRL calibration becomes inaccurate if the electrical length difference between Line and Through standard corresponds to a phase shift below 20°. In practice this means that TRL is only practicable above a threshold frequency  $f_{\text{TRM}}$  which depends on the lengths of the longest line and through standards. The threshold frequency is given by:

$$f_{\text{TRM}} = c_0 / [18 * (l_{\text{long}} - l_{\text{thr}})]$$

where  $l_{\text{long}}$  denotes the electrical length of the longest of the used Line standards,  $l_{\text{thr}}$  the length of the Through. The analyzer assumes  $l_{\text{thr}} \ll l_{\text{long}}$  and calculates  $f_{\text{TRM}} = c_0 / (18 * l_{\text{long}})$ . At frequencies below  $f_{\text{TRM}}$ , TRL calibration is automatically replaced by TRM, provided that the necessary calibration data has been acquired. For a line with  $l_{\text{long}} = 16.666$  cm, the threshold frequency is  $f_{\text{TRM}} = 100$  MHz.

#### Accuracy conditions for the Line(s)

The length error of the Line, converted into a transmission phase error, must be below the minimum difference to the singularity points 0 deg or 180 deg multiplied by two. Suppose that an approximately known Line standard causes a transmission phase 30 deg at the start frequency and of 160 deg at the stop frequency of the sweep. Its length error must cause a phase difference below  $(180 \text{ deg} - 160 \text{ deg}) * 2 = 40 \text{ deg}$ .

#### 3.5.1.10 TNA Calibration

A TNA (Through – Network – Attenuation) calibration requires two-port standards only. Again, the Through standard must be ideally matched and lossless. The Symmetric Network must have the same properties as the Reflect standard used for a TRL calibration, i.e. the magnitude of its reflection coefficient can be unknown but must be non-zero; its phase must be roughly known ( $\pm 90$  deg). The magnitude and phase of the reflection coefficient must be the same at both test ports. The Attenuation standard must be well matched on both sides and cause an attenuation different from 0 dB; the exact value of the transmission coefficient is not important.

As with TRL, TNA calibration is especially useful for planar DUTs. If TNA is not practicable, TRL may be an alternative.



For a unidirectional R&S ZND (see [Chapter 3.1.4.2, "R&S ZND: Unidirectional vs. Bidirectional Operation"](#), on page 16) TNA calibration is not available.

#### 3.5.1.11 Complementary Isolation Measurement

For each port pair in a manual transmission normalization or TOSM calibration, the Through measurement can be complemented by an isolation measurement, accounting for possible crosstalk between the related test ports (e.g. on a test fixture).

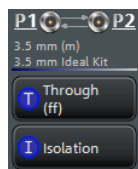

If isolation is measured, the corrected transmission coefficient of the DUT is calculated as

$$(Transmission\ coefficient\ DUT - Isolation) / (Transmission\ coefficient\ Through - Isolation)$$

There is no dedicated physical standard for isolation measurement; it is recommended to suitably terminate the test ports (e.g. with 50  $\Omega$  loads).

### 3.5.2 Calibration Standards and Calibration Kits

A calibration kit is a set of physical calibration standards for a particular connector type. The magnitude and phase response of the calibration standards (i.e. their S-parameters) must be known or predictable within a given frequency range.

The standards are grouped into several types (Open, Through, Match,...) corresponding to the different input quantities for the analyzer's error models. The standard type also determines the equivalent circuit model used to describe its properties. The circuit model depends on several parameters that are stored in the cal kit file associated with the calibration kit.

As an alternative to using circuit models, it is possible to describe the standards by means of S-parameter tables stored in a file.

The analyzer provides a large number of predefined cal kits but can also import cal kit files and create new kits:

- A selection of predefined kits is available for all connector types. The parameters of these kits are displayed in the "Add/Modify Standards" dialog, however, it is not possible to change or delete the kits.
- Imported and user-defined kits can be changed in the "Calibration Kits" dialog and its various sub-dialogs.

Calibration kits and connector types are global resources; the parameters are stored independently and are available irrespective of the current recall set.

#### 3.5.2.1 Calibration Standard Types

The following table gives an overview of the different standards and their circuit models (offset and load models).

**Table 3-5: Calibration standard types**

Standard Type	Characteristics	Ideal Standard	Offset Model	Load Model
Open	Open circuit (one-port)	$\infty \Omega$	<input checked="" type="checkbox"/>	<input checked="" type="checkbox"/>
Short	Short circuit (one-port)	0 $\Omega$	<input checked="" type="checkbox"/>	<input checked="" type="checkbox"/>
Offset short	Short circuit with added electrical length offset, for waveguide calibration (one-port)	0 $\Omega$	<input checked="" type="checkbox"/>	<input checked="" type="checkbox"/>
Match	Matched broadband termination (one-port)	$Z_0$ (characteristic impedance of the connector type)	<input checked="" type="checkbox"/>	<input checked="" type="checkbox"/>
Sliding match	One-port standard consisting of an air line with a movable, low-reflection load element (sliding load)	–	–	–
Reflect	Unknown mismatched standard (one-port)	$\infty \Omega$	<input checked="" type="checkbox"/>	<input checked="" type="checkbox"/>
Through	Through-connection with minimum loss (two-port)	–	<input checked="" type="checkbox"/>	–

Standard Type	Characteristics	Ideal Standard	Offset Model	Load Model
Line1, Line 2	Line(s) for TRL calibration with minimum loss (two-port)	–	<input checked="" type="checkbox"/>	–
Attenuation	Fully matched standard in both directions (two-port; the reflection factor at both ports is zero)	–	–	–
Symm. network	Unknown mismatched reflection-symmetric standard (two-port)	–	<input checked="" type="checkbox"/>	<input checked="" type="checkbox"/>

### Offset parameters

The offset parameters have the following physical meaning:

- The "Delay" is the propagation time of a wave traveling through the standard. The "Electrical Length" is equal to the "Delay" times the speed of light in the vacuum and is a measure for the length of transmission line between the standard and the actual calibration plane. For a waveguide with permittivity  $\epsilon_r$  and mechanical length  $L_{mech}$  the following relations hold:

$$\text{Delay} = \frac{L_{mech} \cdot \sqrt{\epsilon_r}}{c}; \quad \text{Electrical Length} = L_{mech} \cdot \sqrt{\epsilon_r}$$

The default delay is 0 s, the default step width is 1 ns, corresponding to a step width of 299.792 mm for the electrical length. The relations hold for one-port and 2-port standards.

- $Z_0$  is the "Characteristic Impedance" of the standard. If the standard is terminated with  $Z_0$ , then its input impedance is also equal to  $Z_0$ .  $Z_0$  is not necessarily equal to the reference impedance of the system (depending on the "Connector Type") or the terminal impedance of the standard. The characteristic impedance of the standard is only used in the context of calibration. The default characteristic impedance is equal to the reference impedance of the system.
- The "Loss" is the energy loss along the transmission line due to the skin effect. For resistive lines and at RF frequencies the loss is approximately proportional to the square root of the frequency. In Agilent mode the "Offset Loss" is expressed in units of  $\Omega/s$  at a frequency of 1 GHz. The following formula holds for two-port standards:

$$\text{Offset Loss} / [\Omega / s] = \frac{\text{Loss} / [dB] \cdot Z_0 / [\Omega]}{4.3429 / [dB] \cdot \text{delay} / [s]}$$

The conversion formula for one-port standards has an additional factor  $\frac{1}{2}$  on the right-hand side. The reason for this factor is that the Loss in dB accounts for the attenuation along the forward **and** the reverse path (no matter how often the wave actually propagates through the line), whereas the "Offset Loss" is proportional to the attenuation of the line.

To determine an offset loss value experimentally, measure the delay in seconds and the loss in dB at 1 GHz and use the formula above.

The default "Loss" or "Offset Loss" is zero.



The impedance for waveguides is frequency-dependent. If a waveguide line type is selected in the "Cal Connector Types" dialog, the "Char. Imp." field is disabled and indicates "varies" instead of a definite impedance value. Moreover no "Loss" or "Offset Loss" can be set.

### Offset parameters and standard types

Offset parameters are used to describe all types of standards except the Sliding Match and the Attenuation.

- The Sliding Match is a one-port standard with variable load parameters (sliding load) and unspecified length. The reference impedance is fixed and equal to the characteristic impedance of the connector type. No load and offset parameters need to be set.
- The Attenuation is a two-port standard which is fully matched in both directions (the reflection factor at both ports is zero). No load and offset parameters need to be set.

### Load parameters and standard types

Load parameters are used to describe all types of standards except a Through, a Sliding Match, a Line, and an Attenuation.

- The Through standard is a through-connection between two ports with minimum loss which is taken into account by the offset parameters.
- The Sliding Match is a one-port standard with variable load parameters (sliding load), so there is no fixed load model.
- The Line standard is a line of variable length with minimum loss which is taken into account by the offset parameters.
- The Attenuation is a two-port standard which is fully matched in both directions (the reflection factor at both ports is zero). No load and offset parameters need to be set.

### 3.5.2.2 Cal Kit Parameter Types

Available Cal Kits	
	Kit Name
1	N 50 $\Omega$ Ideal Kit
2	3653
3	ZV-Z121
4	ZCAN 50 $\Omega$
5	ZV-Z21 typical

The analyzer uses three types of parameters to describe the calibration standards. The parameter type is the same for all standards in a kit and therefore annexed to the kit name:

- **Universal** parameters (no label) describe calibration kit models with highly standardized components so that the parameters are valid for all calibration kits of the model.
- **Typical** parameters (labeled "typical") approximately describe a calibration kit model. To correct for deviations between the standards, each kit of the model is individually measured and delivered with an additional, kit-specific parameter set. Therefore each typical parameter set "<kit\_name> typical" is complemented by an additional parameter set "<kit\_name>" containing optimized parameters for an individual kit.
- **Ideal** parameters (labeled "Ideal Kit") describe an idealized calibration kit for each connector type; see below.



Make sure to use universal or individual parameter sets if you need to obtain high-precision results. The precision of the calibration kit parameters determine the accuracy of the system error correction and of the measurements. The R&S ZNC/ZND displays a warning if you use a typical or ideal parameter set to calibrate a channel.

Calibration kits can be obtained as network analyzer accessories; refer to the data sheet for the relevant ordering information. The name of all parameter sets is equal to the name of the corresponding calibration kit model.

### Ideal parameters

All ideal kits contain the standards listed below.

**Table 3-6: Ideal standard parameters**

Standard (Gender)	R (Load)	Electrical Length (Offset)
Open (f, m)	$\infty \Omega$	0 mm (Delay: 0 s)
Short (f, m)	$0 \Omega$	0 mm
Offset Short (f, m)	$0 \Omega$	10 mm
Match (f, m)	$Z_0$ (characteristic impedance of the connector type)	0 mm
Sliding Match (f, m)	–	0 mm
Reflect (f, m)	$\infty \Omega$	0 mm
Through (ff, mm, mf)	–	0 mm
Line (ff, mm, mf)	–	10 mm
Attenuation (ff, mm, mf)	–	0 mm
Symm. Network (ff, mm, mf)	–	0 mm

The following additional parameters are used:

- Characteristic impedance:  $Z_0$  (characteristic impedance of the connector type)
- Loss: 0 dB / sqrt(GHz) or (0 G $\Omega$  / s) in Agilent mode
- All inductance and capacitance parameters are set to zero.

#### 3.5.2.3 Sliding Match Standards

The Sliding Match is a one-port standard consisting of an air line with a movable, low-reflection load element (sliding load). This standard is used because a no perfect Match is available over a wide frequency range. However, a series of measurements at a given frequency with equal mismatch and varying phase yields reflection factors that are located on a circle in the Smith chart. The center of this circle corresponds to perfect match. The network analyzer determines and further corrects this match point following I. Kása's circle-fitting algorithm.

To obtain the reflection coefficient for a perfectly matched calibration standard, the Sliding Match must be measured at least at 3 positions which should be unequally



spaced to avoid overlapping data points. Increasing the number of positions to 4 – 6 can improve the accuracy. Moreover it is recommended to use the predefined load positions of the standard.

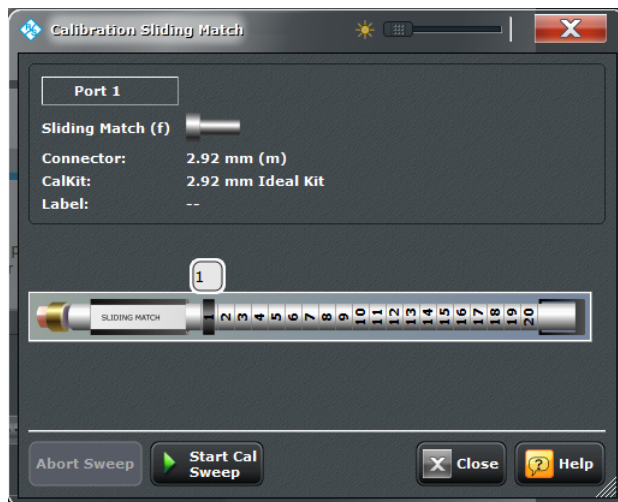

Figure 3-3: Sliding Match: GUI representation

A calibration is valid (and can be applied to the calibrated channel) if either the Match or three positions of the Sliding Match have been measured. However, it is often desirable to acquire calibration data from both standards.



The R&S ZNC/ZND can acquire correction data for up to 20 positions.

The analyzer combines the data in an appropriate manner:

- The Match results are used up to the lower edge of the specified frequency range of the Sliding Match (Min Freq).
- The Sliding Match results are used for frequencies above the Min Freq. In general, the Sliding Match will provide better results than the Match within its specified frequency range.

#### 3.5.2.4 Cal Kit Files

Calibration kit files can be used to store the parameters of a particular calibration kit, to re-load the data and to exchange calibration kits from one network analyzer to another.

##### Cal kit file contents

Cal kit files are independent of the current recall set and contain the following information:

- Name and label of the calibration kit
- Connector type including all connector type parameters (name, polarity, offset model, reference impedance)

- Type, gender and label of all standards in the kit together with the circuit model parameters (offsets, load) or S-parameter tables (.s<n>p file) that are necessary to determine its magnitude and phase response.

By default cal kit files are stored in the

C:\Users\Public\Documents\Rohde-Schwarz\Vna\Calibration directory.

- To **export** cal kit data, the analyzer uses a specific binary file format \*.calkit.
- Three different **import** file formats are supported: R&S ZVA-specific binary cal kit files (\*.calkit), R&S ZVR-specific binary cal kit files (\*.ck), cal kit files in Agilent-specific ASCII formats (\*.csv, \*.prn).



### Importing older R&S ZVR cal kit files

On loading some older R&S ZVR-specific \*.ck files, e.g. the R&S ZV-Z23 cal kit file, the R&S ZNC/ZND generates the message "File does not comply with instrument calibration kit file format". The files must be converted using an R&S ZVR network analyzer equipped with a firmware version V3.52 or higher.

Proceed as follows:

- On the R&S ZVR, press "CAL > CAL KITS > MODIFY KITS > INSTALL NEW KIT" to import the \*.ck file.
- Press "CREATE INST FILE" in the same submenu to export the \*.ck file in a R&S ZNC/ZND-compatible format.
- Import the converted file into the R&S ZNC/ZND.

### \*.csv cal kit files: VNA Cal Kit Manager 2.1

The "VNA Cal Kit Manager" is a free, Windows®-based software tool intended to import, edit, and export \*.csv cal kit files. The software is available for download at <http://www.vnahelp.com/products.html>. The decimal separator used by the "VNA Cal Kit Manager V2.1" depends on the language version of the Windows® operating system: Cal kit files generated on an English operating system contain dots, the ones generated on a German system contain commas.

The network analyzer expects the dot as a separator and displays an error message when a \*.csv file with commas is loaded. Please install the VNA Cal Kit Manager V2.1 on an appropriate (e.g. English) Windows® version to avoid trouble.

### \*.prn cal kit files: PNA Cal Kit Editor

The network analyzer can import and process cal kit files created with the "PNA Cal Kit Editor". The files use the extension \*.prn; the data format is identical to the \*.csv format.

The decimal separator used by the "PNA Cal Kit Editor" depends on the language version of the Windows® operating system: Cal kit files generated on an English operating system contain dots, the ones generated on a German system contain commas.

The network analyzer expects the dot as a separator and displays an error message when a \*.prn file with commas is loaded. Please install the "PNA Cal Kit Editor" on an appropriate (e.g. English) Windows® version to avoid trouble.

### 3.5.3 Calibration Pool

The calibration pool is a collection of correction data sets (cal groups) that the analyzer stores in a common directory

C:\Users\Public\Documents\Rohde-Schwarz\Vna\Calibration\Data. Cal groups in the pool can be applied to different channels and recall sets. Each cal group is stored in a separate file named <CalGroup\_name>.cal. The cal group name can be changed in the "Calibration Manager" dialog.

One of the available cal groups can be set as "Preset User Cal", i.e. the user correction data that shall be restored after a user-defined preset.

If a new channel is created, the channel calibration of the active channel is also applied to the new channel. See also [Calibration Labels](#).

### 3.5.4 Calibration Labels

The following labels in the trace list inform you about the status or type of the current system error correction.

**Table 3-7: Calibration labels (system error correction)**

Label	Meaning
Cal	The system error correction is applied without interpolation. This means that a set of measured correction data is available at each sweep point.
Cal int	The system error correction is applied, however, the correction data for at least one sweep point is interpolated from the measured values. This means that the channel settings have been changed so that a current sweep point is different from the calibrated sweep points. It is not possible to disable interpolation.
Cal Off	The system error correction is no longer applied (e.g. "User Cal Active" is disabled). See also "Cal Off label" on page 74.

### 3.5.5 Automatic Calibration

A calibration unit is an integrated solution for automatic system error correction of vector network analyzers. Rohde & Schwarz offers a wide range of calibration units for different frequency ranges and connector types.

For R&S ZNC/ZND analyzers, the new economic calibration unit R&S ZN-Z151 is recommended, however, all of the calibration units listed below can be used.

The connector types of the calibration unit should be selected according the connectors of the DUT.



Calibration unit	Frequency range	Connector type	No. of ports	Order no.
R&S ZN-Z51	100 kHz to 8.5 GHz	3.5 mm (f)	4	1319.5507.34
R&S ZN-Z51	100 kHz to 8.5 GHz	3.5 mm (f)	2	1319.5507.32
R&S ZN-Z51	100 kHz to 8.5 GHz	type N (f)	4	1319.5507.74
R&S ZN-Z51	100 kHz to 8.5 GHz	type N (f)	2	1319.5507.72
R&S ZN-Z51 custom configuration	<p>The R&amp;S ZN-Z51 allows a free/mixed port configuration with possible connector types N (m/f), 3.5 mm (m/f) and 7/16 (m/f).</p> <p>With an N(f)-type CalU serving as base unit, for each available port an alternative connector type N(m), 3.5 mm (m/f) or 7/16 (m/f) can be selected. For N(f)-type models alternative connectors can be also retrofitted, but the calibration unit has to be sent to service for that and has to be characterized again. See the data sheet for ordering information.</p> <p>The frequency range for 7/16 connector ports is limited to 100 kHz to 7.5 GHz.</p>			
R&S ZN-Z151	100 kHz to 8.5 GHz	type N (f)	2	1317.9134.72
R&S ZN-Z151	100 kHz to 8.5 GHz	SMA (f)	2	1317.9134.32
R&S ZN-Z152	100 kHz to 8.5 GHz	SMA (f)	6	1319.6003.36
R&S ZN-Z153	100 kHz to 8.5 GHz	SMA (f)	4	1319.6178.34
R&S ZN-Z154	100 kHz to 8.5 GHz	SMA (f)	6, 12, 18 or 24	1319.5120.02
	<p>Options R&amp;S ZN-Z154-B22, -B32 and -B42 (order nos 1319.5136.22, 1319.5136.32 and 1319.5136.42) extend the R&amp;S ZN-Z154 base unit with additional ports 7-12, 13-18 and 19-24, respectively.</p>			
R&S ZV-Z51	300 kHz to 8 GHz	3.5 mm (f)	4	1164.0515.30
R&S ZV-Z51	300 kHz to 8 GHz	type N (f)	4	1164.0515.70
R&S ZV-Z52	10 MHz to 24 GHz	3.5 mm (f)	4	1164.0521.30
R&S ZV-Z52	100 kHz to 18 GHz	type N (f)	4	1164.0521.70

Calibration unit	Frequency range	Connector type	No. of ports	Order no.
R&S ZV-Z53	300 kHz to 18 GHz	type N (f)	2	1164.0473.72
R&S ZV-Z53	300 kHz to 24 GHz	3.5 mm (f)	2	1164.0473.32
R&S ZV-Z54	10 MHz to 40 GHz	2.92 mm (f)	2	1164.0467.92
R&S ZV-Z55	10 MHz to 50 GHz	2.4 mm (f)	2	1164.0480.42
R&S ZV-Z58	300 kHz to 8 GHz	type N (f)	8	1164.0638.78
R&S ZV-Z58	300 kHz to 8 GHz	3.5 mm (f)	8	1164.0638.38
R&S ZV-Z58	10 MHz to 20 GHz	3.5 mm (f)	6	1164.0450.36
R&S ZV-Z59	10 MHz to 20 GHz	3.5 mm (f)	6	1164.0450.36

The units contain calibration standards that are electronically switched when a calibration is performed. The calibration kit data for the internal standards are also stored in the calibration unit, so that the analyzer can calculate the error terms and apply the calibration without any further input.

#### Advantages of automatic calibration

Automatic calibration is generally faster and more secure than manual calibration, because:

- There is no need to connect several standards manually. The number of connections to be performed quickly increases with the number of ports.
- Invalid calibrations due to operator errors (e.g. wrong standards or improper connections) are almost excluded.
- No need to handle calibration kit data.
- The internal standards don't wear out because they are switched electronically.

#### Limitations of automatic calibration

Calibration types TOM, TSM, TRM, TRL, TNA are not available.



For a unidirectional R&S ZND (see [Chapter 3.1.4.2, "R&S ZND: Unidirectional vs. Bidirectional Operation"](#), on page 16) automatic calibration is not available at all.

### NOTICE

#### Safety instructions

Please observe the safety instructions in the "Technical Information" provided with the calibration unit to avoid any damage to the unit and the network analyzer. Safety-related aspects of the connection and operation of the units are also reported in the following sections.

### 3.5.5.1 Connecting the Calibration Unit

The calibration units provide the following connectors:

- USB type B connector at the rear, which is used to power-supply and control the unit. A USB cable for connection to the network analyzer is provided with the calibration unit.
- RF connectors, which are connected to the test ports. The connector type is equal for all ports. Depending on the calibration unit model, it is either type N (f), 3.5 mm (f), 2.92 mm (f) or 2.4 mm (f).

**To connect the unit,**

1. Switch on and start up your network analyzer.
2. To protect your equipment against ESD damage use the wrist strap and grounding cord supplied with the instrument and connect yourself to the GND connector at the front panel.
3. Connect the USB type A connector of the USB cable to any of the USB type A connectors of the analyzer. Connect the USB type B connector of the USB cable to the USB type B connector of the calibration unit.
4. Wait until the operating system has recognized and initialized the new hardware. When the unit is connected for the first time, this may take longer than in normal use.

The unit is ready to be used, see [Chapter 3.5.5.2, "Performing an Automatic Calibration"](#), on page 95.



#### **Safety aspects**

- The calibration unit is intended for direct connection to R&S ZNC/ZND network analyzers following the procedure described above. You can also connect the unit before switching on the analyzer. Do not connect the unit to other USB hosts, e.g. a PC, or insert any USB hubs between the analyzer and the unit, as this may cause damage to the unit or the host.
- You can connect several calibration units to the different USB ports of the analyzer. You can also connect cal units and other devices (mouse, USB memory stick etc.) simultaneously.
- An unused calibration unit may remain connected to the USB port while the network analyzer is performing measurements. It must be disconnected during a firmware update.
- It is safe to connect or disconnect the calibration unit while the network analyzer is operating. Never connect or disconnect the unit while data is being transferred between the analyzer and the unit. Never connect the unit during a firmware update.

### 3.5.5.2 Performing an Automatic Calibration

After connection and initialization of the calibration unit, perform the automatic calibration of the related test ports using the "Calibration Unit" wizard (CHANNEL > CAL > Start Cal (Cal Unit); see [Chapter 4.4.3.2, "Calibration Unit Wizard"](#), on page 253). The wizard will indicate the required port (re-)connections.



The assignment between the analyzer ports and the cal unit ports can be detected automatically. If auto-detection fails (e.g. because of a high attenuation in the signal path), you can either enter the port assignment manually or connect matching port numbers and select "Default Port Assignment".

When finished, remove the test cables from the unit, connect your DUT instead and perform calibrated measurements.



#### Accuracy considerations

To ensure an accurate calibration, please observe the following items:

- Unused ports of the calibration unit must be terminated with a 50  $\Omega$  match.
- No adaptors must be inserted between the calibration unit and the test ports of the analyzer.
- Allow for a sufficient warm-up time before starting the calibration. Refer to the "Specifications" of the calibration unit for details.
- To ensure best accuracy the analyzer automatically reduces the source power to –10 dBm. If the test setup contains a large attenuation, deactivate "Auto Power Reduction for Cal Unit" in the "Calibration" tab of the "System Config" dialog and ensure an input power of –10 dBm at the ports of the calibration unit (please also refer to the "Specifications" of the calibration unit).

#### NOTICE

##### Maximum RF input power

The maximum RF input power of the calibration unit is beyond the RF output power range of the analyzer, so there is no risk of damage if the device is directly connected to the test ports. If you use an external power amplifier, make sure that the maximum RF input power of the calibration unit quoted in the data sheet is never exceeded.

The available calibration types depend on the number of ports to be calibrated. For a single calibrated port, the reflection calibration types are available ("Refl Norm Open", "Refl Norm Short", "Refl OSM").

If 2 ports shall be calibrated, the analyzer provides the following additional calibration types:

- A single full 2-port (TOSM or UOSM) calibration.
- Two full one-port calibrations for the two calibrated ports.

- A one path two port calibration. The node port is the source port for the one path two port calibration (fully calibrated port).
- A transmission normalization (bidirectional, forward or reverse). "Forward" transmission normalization means that the signal direction is from port 1 to port 2.



For a unidirectional R&S ZND (see [Chapter 3.1.4.2, "R&S ZND: Unidirectional vs. Bidirectional Operation"](#), on page 16) neither full 2-port nor transmission normalization calibrations are available. A one path two port calibration is only possible with port 1 as the node port.

### 3.5.5.3 Characterization of Calibration Units

Each calibration unit is delivered with factory characterization data which ensure an accurate calibration for all standard applications. For specific modifications of the test setup, e.g. the connection of additional adapters to a calibration unit, a modified set of characterization data (suitable for the cal unit with adapters) may be desirable. The R&S ZNC/ZND provides a characterization wizard which you can use to generate your own characterization data sets for (modified) R&S cal units. The characterization data can be stored in the cal unit and used for automatic calibration whenever needed.



For a unidirectional R&S ZND (see [Chapter 3.1.4.2, "R&S ZND: Unidirectional vs. Bidirectional Operation"](#), on page 16) calibration unit characterization is not available.

A cal unit characterization can be performed in a frequency sweep. The network analyzer must be properly calibrated, with the reference plane at the input ports of the (modified) cal unit to be characterized.

The procedure involves the following steps:

1. Perform a calibration of your network analyzer, using the test setup and the calibration type you wish to perform with your calibration unit.
2. Connect the calibration unit to the network analyzer.
3. Access the "Characterize Cal Unit" dialog ("CHANNEL > CAL > Cal Devices > Characterize Cal Unit") and start the characterization wizard.
4. Step through the wizard, following the instructions in the dialogs.

#### Dependency between calibration types and characterization data

A cal unit characterization provides full one-port (OSM) data at the selected ports plus two-port (Through) data between any pair of selected ports. The measurement of Through data is optional, however, it is required for some calibration types. The following table gives an overview.



Calibration type	Characterization data required
Refl Norm Open Refl Norm Short Refl OSM UOSM TOSM	OSM CalPort 1, OSM CalPort2 ... (all calibrated ports)
Trans Norm Both Trans Norm Forward One Path Two Ports	OSM CalPort 1, OSM CalPort2 ... (all calibrated ports), Through (between all pairs of ports)

### 3.5.6 Scalar Power Calibration

The purpose of a scalar power calibration is to ensure accurate source power levels and power readings at a particular position (calibration plane) in the test setup. Scalar power calibration is essentially different from the system error correction described in [Chapter 3.5, "Calibration"](#), on page 73.

A power calibration is required for accurate measurement of wave quantities or ratios (see section [Chapter 3.1.5, "Data Flow"](#), on page 18). For best accuracy, choose a calibration method according to the table below.

**Table 3-8: System error correction and power calibration for various measurements**

Measurement	System error correction	Scalar power calibration
S-parameter meas. on linear DUTs	<b>Yes, necessary</b>	Not necessary
Meas. of wave quantities or ratios on linear or non-linear DUTs	Yes, recommended	a-wave: power (source) necessary b-wave: meas. receiver necessary
Power sweep, e.g. for compression point measurement	Yes, necessary	Power (source): necessary Meas. receiver: not necessary

In general, a power calibration involves two stages:

1. **Source power calibration:** An external power meter is connected to the calibration plane. The analyzer uses the power meter readings to calibrate its reference receiver. Subsequently, it modifies its source power so that the calibrated reference receiver reading corresponds to the desired source power value (flatness calibration).
2. **Measurement receiver calibration:** The analyzer uses the calibrated source signal to adjust the power reading at the receive port.

### 3.5.6.1 Source Power Calibration

A source power calibration ensures an accurate power of the generated wave at an arbitrary calibration plane in the measurement path. Typically the calibration plane corresponds to the input of the DUT.

In a frequency sweep, the power at the calibration plane is maintained at a constant "Cal Power" value. The source power calibration eliminates frequency response errors in the signal path between the source and the calibration plane. It is possible to introduce an arbitrary attenuation or gain into the signal path so that the cal power is not restricted to the power range of the source. A typical application for a power calibration in a frequency sweep is the measurement of the gain of an amplifier across a frequency range but at a fixed input power.

In a power sweep, the power calibration ensures that the power at the calibration plane is either constant or a linear function of the stimulus power. A typical application for a power calibration in a power sweep is the measurement of the gain of an amplifier across a power range but at a fixed frequency. The correction data acquired in a frequency or power sweep is re-used if a "Time" or "CW Mode" sweep is activated.

#### Calibration procedure

The source power calibration requires an external power meter, to be connected via GPIB bus, USB or LAN interface. Use the USB-to-IEC/IEEE Adapter (option R&S ZVAB-B44 ) to control devices equipped with a GPIB interface. The power sensor can be connected directly at the calibration plane or to any other point in the test setup where the signal power is known to be proportional to the power at the calibration plane.

The source power calibration involves several steps:

1. **Reference receiver calibration:** The analyzer performs a first calibration sweep at the source power that is likely to produce the target power ("Cal Power") at the calibration plane. A known attenuation or gain at the source port and in the signal path between the source port and the calibration plane can be taken into account:

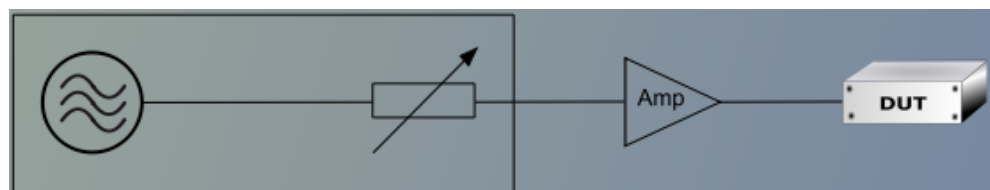

The power which the external power meter measured at the calibration plane is displayed in the calibration sweep diagram, together with the reference receiver reading. The difference between the two traces is used to correct the reference receiver reading, i.e. the reference receiver is calibrated by the external power meter results.

2. **Internal source power flatness calibration:** In the following steps, the calibrated reference receiver is used to adjust the source power. To this end, the R&S ZNC/ZND performs a series of calibration sweeps at varying source power

until the number of "Total Readings" is reached or until the deviation between the calibrated reference receiver power and the cal power is below a specified "Tolerance". The external power meter is no longer used for these repeated calibration sweeps; everything is based on the previously calibrated reference receiver. This speeds up the calibration procedure but does not impair its accuracy.

3. After the flatness calibration, the R&S ZNC/ZND performs an additional verification sweep in order to demonstrate the accuracy of the calibration.

After the source power calibration, one can expect the power at the calibration plane to be within the range of uncertainty of the power meter. The reference receiver reading corresponds to the calibrated source power. After a change of the sweep points or sweep range, the analyzer interpolates or extrapolates the calibration data; see [Chapter 3.5.6.3, "Power Calibration Labels"](#), on page 100.

### 3.5.6.2 Measurement Receiver Calibration

A measurement receiver calibration ensures that the power readings at a specified receive port of the analyzer (b-waves) agree with the source power level calibrated at an arbitrary calibration plane. Typically, the calibration plane is at the input of the receiver so that the calibration eliminates frequency response errors in the calibrated receiver.

In contrast, the reference receiver calibration, which is automatically performed together with the (source) power calibration, ensures correct power readings for the generated waves (a-waves).

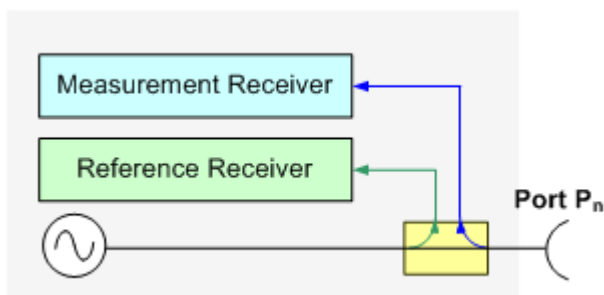

A measurement receiver calibration generally improves the accuracy of power (wave quantity) measurements. The correction data acquired in a frequency or power sweep is re-used if a "Time" or "CW Mode" sweep is activated.

#### Calibration procedure

The measurement receiver calibration is based on a received wave  $b_n$  with known power. The calibration involves a connection to a (previously source power-calibrated) source port.

The received wave to calibrate is generated by the other analyzer port  $P_m$  ( $m \neq n$ ). Alternatively, it is possible to connect an Open or Short standard to port  $P_n$ : The measurement receiver is calibrated using the reflected wave  $a_n$ .

The measurement receiver calibration involves a single calibration sweep. The calibration sweep is performed with current channel settings but with a maximum IF bandwidth of 10 kHz. Smaller IF bandwidths are maintained during the calibration sweep; larger bandwidths are restored after the sweep. The analyzer measures the power at each sweep point, compares the result with the nominal power of the source, and compiles a correction table.

An acoustic signal indicates the end of the calibration sweep. At the same time, a checkmark symbol next to the calibrated source indicates the status of the measurement receiver calibration. After a change of the sweep points or sweep range, the analyzer interpolates or extrapolates the calibration data.

### 3.5.6.3 Power Calibration Labels

Power calibration labels in the trace list for wave quantities and ratios inform you about the status and type of the current scalar power calibration. The labels appear in the following instances:

- For a-waves, if a source power calibration is available.
- For b-waves, if a measurement receiver power calibration is available.
- For ratios between a- and b-waves, if both a source power and a measurement receiver power calibration is available.



#### Calibration of S-parameters

S-parameters and derived quantities (e.g. impedances, admittances, stability factors) are assumed to be linear.

Therefore, a scalar power calibration is not applied to S-parameters and derived quantities; no power calibration labels appear in the trace list.

**Table 3-9: Power calibration labels**

Label	Meaning
PCal	A scalar power calibration is available and applied without interpolation or extrapolation (see below). This means that a set of measured correction data is available at each sweep point.
PCai	The power calibration is applied, however, the correction data for at least one sweep point is interpolated from the measured values. This means that the channel settings have been changed so that a current sweep point is different from the calibrated sweep points. It is not possible to disable interpolation.
PCao	The power calibration is applied, however, the source power (channel base power) was changed.
PCax	The power calibration is applied, however the calibration data is extrapolated. The current stimulus range exceeds the calibrated stimulus range. The power calibration data of the first calibrated sweep point is used for all smaller stimulus values; the power calibration data of the last calibrated sweep point is used for all larger stimulus values.
PCal Off	The power calibration is no longer applied (e.g. deliberately turned off in the "Calibration > Use Cal" softtool panel).

A lower label in the list has priority over the higher labels (e.g. if the power calibration is interpolated and the source power is changed, then the label PCao is displayed).

### Interpolation and extrapolation

The analyzer can interpolate and extrapolate power correction data so that a source or receiver power calibration can be reused after a change of the frequency sweep range:

- At new sweep points within the calibrated sweep range, interpolation is applied to calculate the correction data. A label "PCai" in the trace list indicates an interpolated power calibration.
- At new sweep points outside the calibrated sweep range, the correction values are extrapolated: Sweep points below the lowest calibrated frequency are assigned the correction value of the lowest frequency. Sweep points above the highest calibrated frequency are assigned the correction value of the highest frequency. A label "PCax" in the trace list indicates an extrapolated power calibration.

#### 3.5.6.4 Extended Test Setups

The power calibration data can be modified to account for an additional two-port device in the test setup. The known transmission coefficients of the two-port can be entered manually or automatically ("CHANNEL > CAL > Pwr Cal Settings > Transm. Coefficients"). The R&S ZNC/ZND supports two different test scenarios.

##### A: Two-port at DUT (during measurement)

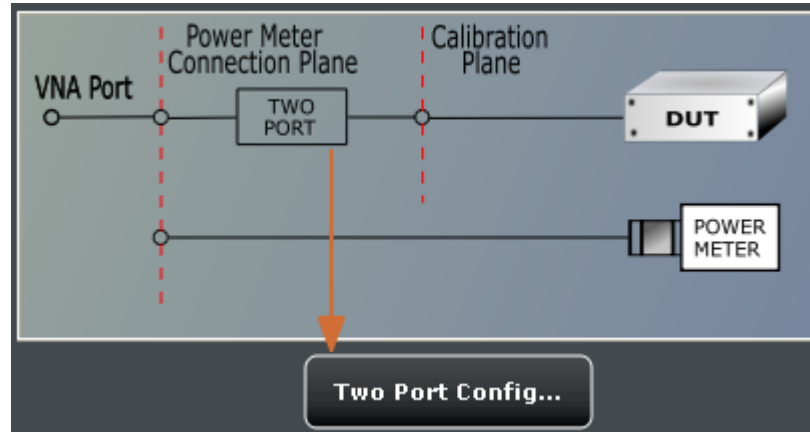

Test and measurement procedure:

1. Perform the calibration without the additional two-port. During the calibration the analyzer decreases the power sensor values by the 2-port transmission coefficients to move the calibration plane of the power calibration towards the input of the DUT. The calibration plane corresponds to the output of the 2-port which is placed in-between the network analyzer port and the DUT.
2. Perform the measurement with the additional two-port.

**Practical example:** On-wafer measurements. The power sensor cannot be directly connected to the input of the DUT. The transmission coefficients of the wafer probe are used for the power meter correction.

#### B: Two-port at power meter (during calibration)

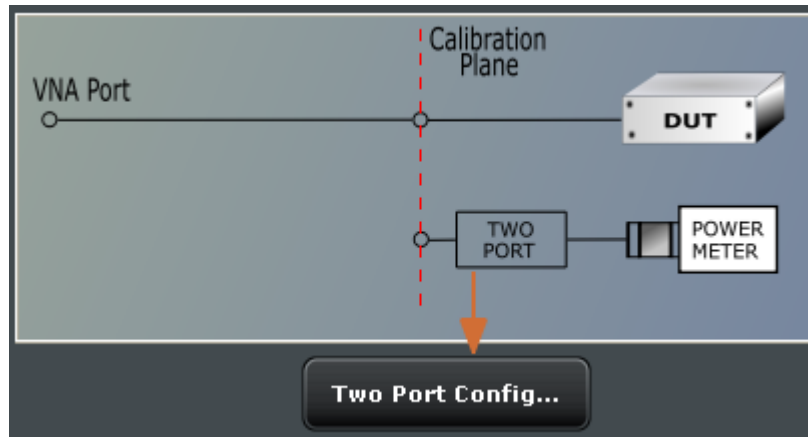

Test and measurement procedure:

1. Perform the calibration with the additional two-port between the analyzer port and the power sensor. During the calibration the analyzer increases the power sensor values by the 2-port transmission coefficients to move the calibration plane of the power calibration towards the input of the DUT. The calibration plane corresponds to the input of the additional 2-port.
2. Perform the measurement without the additional two-port.

**Practical example:** An adapter or attenuator with known attenuation is needed to connect the power sensor to the test port of the network analyzer. The transmission coefficients of the adapter are used for the power meter correction.

### 3.5.7 Parallel Calibration of Multiple Channels

If multiple channels are configured, clearly they can be calibrated one after the other, but this may be quite inefficient in terms of necessary reconnections of calibration standards (or calibration units).

The R&S ZNC/ZND offers two possibilities to calibrate several channels in parallel:

- Calibrate all channels in one go using the same calibration type on the same ports for all channels  
In this case, for each port to be calibrated the same calibration standards have to be connected and after connecting one of these standards, a calibration sweep has to be performed for each channel.

This simple mode of parallel calibration is supported from the analyzer GUI (see ["Calibrate all Channels"](#) on page 257) and via remote control (see [\[SENSe:\]CORrection:COLlect:CHANnels:ALL](#) on page 612).

- Calibrate a subset of the available channels, possibly using different ports and calibration types

In this case, for each port to be calibrated a different set of calibration standards might be required and for each of these standards only a subset of the available channels might have to be swept.

This advanced mode of parallel calibration is available via **remote control only** (see [SENSe:]CORRection:COLLect:CHANnels:MCTypes on page 613).

## 3.6 Offset Parameters and Embedding

The R&S ZNC/ZND functionality described in this section complements the calibration, compensating for the effect of known transmission lines between the calibrated reference plane and the DUT.

### 3.6.1 Offset Parameters

Offset parameters compensate for the known length and loss of a (non-dispersive and perfectly matched) transmission line between the calibrated reference plane and the DUT.

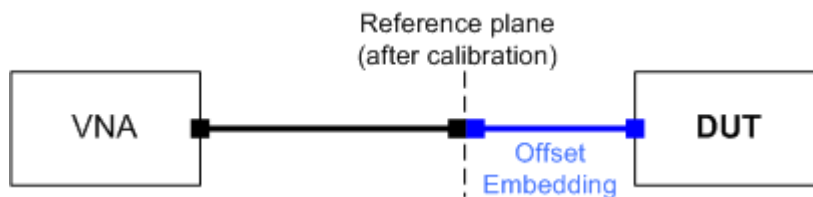

The analyzer can also auto-determine length and loss parameters, assuming that the actual values should minimize the group delay and loss across the sweep range.

#### 3.6.1.1 Definition of Offset Parameters

The **delay** is the propagation time of a wave traveling through the transmission line. The **electrical length** is equal to the delay times the speed of light in the vacuum and is a measure for the length of the transmission line between the standard and the actual calibration plane. For a line with permittivity  $\epsilon_r$  and **mechanical length**  $L_{\text{mech}}$  the delay and the electrical length are calculated as follows:

$$\text{Delay} = \frac{L_{\text{mech}} \cdot \sqrt{\epsilon_r}}{c}; \quad \text{Electrical Length} = L_{\text{mech}} \cdot \sqrt{\epsilon_r}$$

In the "CHANNEL > OFFSET EMBED > Offset" tab, "Delay", "Electrical Length" and "Mechanical Length" are coupled parameters. When one of them is changed, the other two are adjusted accordingly.

For a non-dispersive DUT, the delay defined above is constant over the considered frequency range and equal to the negative derivative of the phase response with respect

to the frequency (see mathematical relations). The length offset parameters compensate for a constant delay, which is equivalent to a linear phase response.

### 3.6.1.2 Definition of Loss Parameters

The **loss "L"** is the attenuation of a wave when traveling through the offset transmission line. In logarithmic representation, the loss can be modeled as the sum of a constant and a frequency-dependent part. The frequency dependence is essentially due to the skin effect; the total loss can be approximated by an expression of the following form:

$$Loss(f) = [Loss(f_{ref}) - Loss_{DC}] \sqrt{\frac{f}{f_{ref}}} + Loss_{DC}$$

The "Loss at DC"  $Loss_{DC}$ , the reference "Frequency for Loss"  $f_{ref}$ , and the loss at the reference frequency  $Loss(f_{ref})$  are empirical parameters for the transmission lines connected to each port which can be entered in the "CHANNEL > OFFSET EMBED > One Way Loss" tab. For a lossless transmission line,  $Loss_{DC} = Loss(f_{ref}) = 0$  dB. In practice, the frequency-dependent loss often represents the dominant contribution so that  $Loss_{DC}$  can be set to zero.

Experimentally, the two loss values  $Loss_{DC}$  and  $Loss(f_{ref})$  are determined in two separate measurements at a very low frequency ( $f \rightarrow 0$ ) and at  $f = f_{ref}$ .

### 3.6.1.3 Auto Length

The "Auto Length" function ("CHANNEL > OFFSET EMBED > Offset > Auto Length") adds an electrical length offset to a test port with the condition that the residual delay of the active trace (defined as the negative derivative of the phase response) is minimized across the entire sweep range. If "Delay" is the selected trace format, the entire trace is shifted in vertical direction and centered around zero. In phase format, the "Auto Length" corrected trace shows the deviation from linear phase.

#### Length and delay measurement, related settings

"Auto Length" is suited for length and delay measurements on transmission lines.

1. Connect a (non-dispersive) cable to a single analyzer port no.  $n$  and measure the reflection factor  $S_{nn}$ .
2. Select "Auto Length".

The delay is displayed in the "CHANNEL > OFFSET EMBED > Offset > Auto Length" tab. The cable length, depending on the velocity factor, can be read in the "Mechanical Length" field.

It is also possible to determine cable lengths using a transmission measurement. Note that "Auto Length" always provides the **single** cable length and the delay for a propagation in **one** direction.



The analyzer provides alternative ways for delay measurements:

1. Measure the reflection factor and select "TRACE > FORMAT > Delay". This yields the delay for propagation in forward and reverse direction and should be approx. twice the "Auto Length" result. For transmission measurements, both results should be approx. equal.
2. Measure the reflection factor and select "TRACE > FORMAT > Phase". Place a marker to the trace and activate "TRACE > TRACE CONFIG > Trace Statistics > Phase / El Length". This yields the delay in one direction and should be approx. equal to the "Auto Length" result.

The measurement results using trace formats and trace statistics functions depend on the selected delay aperture and evaluation range. Auto Length is particularly accurate because it uses all sweep points. For non-dispersive cables, aperture and evaluation range effects are expected to vanish.

Use "Zero Delay at Marker" to set the delay at a special trace point to zero.

#### **Preconditions for Auto Length, effect on measured quantities and exceptions**

"Auto Length" is enabled if the measured quantity contains the necessary phase information as a function of frequency, and if the interpretation of the results is unambiguous:

- A frequency sweep must be active.
- The measured quantity must be an S-parameter, ratio, wave quantity, a converted impedance or a converted admittance.

The effect of "Auto Length" on S-parameters, wave quantities and ratios is to eliminate a linear phase response as described above. The magnitude of the measured quantity is not affected. Converted admittances or impedances are calculated from the corresponding "Auto Length" corrected S-parameters. Y-parameters, Z-parameters and stability factors are not derived from a single S-parameter, therefore "Auto Length" is disabled.

#### **Auto Length for logical ports**

The "Auto Length" function can be used for balanced port configurations as well. If the active test port is a logical port, then the same length offset must be assigned to both physical ports that are combined to form the logical port. If different length offsets have been assigned to the physical ports before, they are both corrected by the same amount.

#### **3.6.1.4 Auto Length and Loss**

The "Auto Length and Loss" function ("CHANNEL > OFFSET EMBED > One Way Loss > Auto Length and Loss") determines all offset parameters such that the residual group delay of the active trace (defined as the negative derivative of the phase response) is minimized and the measured loss is minimized as far as possible across the entire sweep range.

"Auto Length and Loss" involves a two-step procedure:

- An "Auto Length" correction modifies the phase of the measured quantity, minimizing the residual group delay. The magnitude of the measured quantity is not affected.
- The "Auto Loss" correction modifies the magnitude of the measured quantity, leaving the (auto length-corrected) phase unchanged.

#### **Preconditions for Auto Length and Loss, effect on measured quantities and exceptions**

"Auto Length and Loss" is enabled if the measured quantity contains the necessary phase information as a function of the frequency, and if the interpretation of the results is unambiguous:

- A frequency sweep must be active.
- The measured quantity must be an S-parameter, ratio, wave quantity, a converted impedance or a converted admittance.

The effect of "Auto Length and Loss" on S-parameters, wave quantities and ratios is to eliminate a linear phase response and account for a loss as described above. Converted admittances or impedances are calculated from the corresponding "Auto Length and Loss" corrected S-parameters. Y-parameters, Z-parameters and stability factors are not derived from a single S-parameter, therefore "Auto Length and Loss" is disabled.

#### **Calculation of loss parameters**

The loss is assumed to be given in terms of the DC loss  $Loss_{DC}$ , the reference frequency  $f_{ref}$ , and the loss at the reference frequency  $Loss(f_{ref})$ . The formula used in the Auto Loss algorithm is similar to the formula for manual entry of the loss parameters (see [Chapter 3.6.1.2, "Definition of Loss Parameters"](#), on page 104).

The result is calculated according to the following rules:

- The reference frequency  $f_{ref}$  is kept at its previously defined value (default: 1 GHz).
- The DC loss  $c$  is zero except for wave quantities and for S-parameters and ratios with maximum dB magnitude larger than  $-0.01$  dB.
- "Auto Length and Loss" for a wave quantity centers the corrected dB magnitude as close as possible around 0 dBm.
- "Auto Length and Loss" for S-parameters and ratios centers the corrected dB magnitude as close as possible around 0 dB.

The resulting offset parameters are displayed in the "CHANNEL > OFFSET EMBED > Offset" tab.

#### **Auto Length and Loss for logical ports**

The "Auto Length and Loss" function can be used for balanced port configurations as well. If the active test port is a logical port, then the same offset parameters must be assigned to both physical ports that are combined to form the logical port. If different offset parameters have been assigned to the physical ports before, they are both corrected by the same amount.

### 3.6.1.5 Fixture Compensation

Fixture compensation is an automated length offset and loss compensation for test fixtures. The analyzer performs a one-port reflection measurement at each port, assuming the inner contacts of the test fixtures to be terminated with an open or short circuit.

Fixture compensation complements a previous system error correction and replaces a possible manual length offset and loss correction. For maximum accuracy, it is recommended to place the reference plane as close as possible towards the outer test fixture connectors using a full n-port calibration. The fixture compensation is then carried out in a second step, it only has to compensate for the effect of the test fixture connections.

The following features can further improve the accuracy of the fixture compensation:

- "Direct Compensation" provides a frequency-dependent transmission factor (instead of a global electrical length and loss).
- "Open and Short" causes the analyzer to calculate the correction data from two subsequent sweeps. The results are averaged in order to compensate for errors due to non-ideal terminations.

#### Auto Length and Loss vs. Direct Compensation

"Auto Length and Loss" compensation is a descriptive correction type: The effects of the test fixture connection are traced back to quantities that are commonly used to characterize transmission lines.

Use this correction type if your test fixture connections have suitable properties in the considered frequency range:

- The electrical length is approximately constant.
- The loss varies essentially due to the skin effect.

"Direct Compensation" provides a frequency-dependent transmission factor. The phase of the transmission factor is calculated from the square root of the measured reflection factor, assuming a reciprocal test fixture. The sign ambiguity of this calculated transmission factor is resolved by a comparison with the phase obtained in an Auto Length calculation. This compensation type is recommended for test fixture connections that do not have the properties described above.

A "Direct Compensation" resets the offset parameters to zero.

#### Open / Short vs. Open and Short compensation

A non-ideal open or short termination of the test fixture connections during fixture compensation impairs subsequent measurements, causing an artificial ripple in the measured reflection factor of the DUT. If you observe this effect, an "Open and Short" compensation may improve the accuracy.

"Open and Short" compensation is more time-consuming because it requires two consecutive fixture compensation sweeps for each port, the first with an open, the second with a short circuit. The analyzer automatically calculates suitable averages from both fixture compensation sweeps in order to compensate for the inaccuracies of the individual "Open and Short" compensations.

### 3.6.1.6 Application and Effect of Offset Parameters

Offset and loss parameters can be particularly useful if the reference plane of the calibration cannot be placed directly at the DUT ports, e.g. because the DUT has non-coaxial ports and can only be measured in a test fixture. Offset parameters can also help to avoid a new complete system error correction if a cable with known properties has to be included in the test setup.

- A positive length offset moves the reference plane of the port towards the DUT, which is equivalent to deembedding the DUT by numerically removing a (perfectly matched) transmission line at that port.
- A negative offset moves the reference plane away from the DUT, which is equivalent to embedding the DUT by numerically adding a (perfectly matched) transmission line at that port.

The offset parameters are also suited for length and delay measurements; see [Chapter 3.6.1.3, "Auto Length"](#), on page 104. The parameters cannot compensate for a possible mismatch in the test setup.

Each offset parameter is assigned to a particular port. The delay parameters affect the phase of all measured quantities related to this port; the loss parameters affect their magnitude. An offset at port 1 affects the S-parameters  $S_{11}$ ,  $S_{21}$ ,  $S_{12}$ ,  $S_{31}$ ... Some quantities (like the Z-parameters) depend on the whole of all S-parameters, so they are all more or less affected when one S-parameter changes due to the addition of an offset length.



To account for the propagation in both directions, the phase shift of a reflection parameter due to a given length offset is twice the phase shift of a transmission parameter. If, at a frequency of 300 MHz, the electrical length is increased by 250 mm ( $\lambda/4$ ), then the phase of  $S_{21}$  increases by 90 deg, whereas the phase of  $S_{11}$  increases by 180 deg.

Equivalent relations hold for the loss.

If the trace is displayed in "Delay" format, changing the offset parameters simply shifts the whole trace in vertical direction.

The sign of the phase shift is determined as follows:

- A positive offset parameter causes a positive phase shift of the measured parameter and therefore reduces the calculated group delay.
- A negative offset parameter causes a negative phase shift of the measured parameter and therefore increases the calculated group delay.

### 3.6.1.7 Offset Parameters for Balanced Ports

The offset parameters can be used for balanced port configurations:

- Offset parameters must be assigned to both physical ports of a logical port.
- "Auto Length" corrects the length offset of both physical ports of a logical port by the same amount.

## 3.7 Optional Extensions and Accessories

The network analyzer can be upgraded with a number of hardware and software options, providing enhanced flexibility and an extended measurement functionality. The available options are listed in the "Info" dialog ("SETUP > Setup > Info..."). For a complete list of options, accessories, and extras refer to the product brochure of your analyzer or to the "Ordering Information" section of the R&S ZNC/ZND product pages on the internet.

The following sections provide an introduction to the software and hardware options described in this documentation. The use of external power meters does not require any additional hardware or software options; it is described at the end of the chapter.

### 3.7.1 Frequency Range Extension to 8.5 GHz for unidirectional R&S ZND

#### Option R&S ZND-K1

Software option R&S ZND-K1 increases the upper frequency limit of a unidirectional R&S ZND (i.e. not equipped with R&S ZND-K5) from 4.5 GHz to 8.5 GHz.



#### Recalibration Required

Although this is a software option, the R&S ZND has to be recalibrated at Rohde & Schwarz service in order to comply with the specifications of the data sheet.

---

### 3.7.2 Bidirectional measurements 100 kHz to 4.5 GHz for R&S ZND

#### Option R&S ZND-K5

Software option R&S ZND-K5 enables bidirectional measurements for a R&S ZND with standard frequency range (i.e without option R&S ZND-K1).



#### Recalibration Required

Although this is a software option, the R&S ZND has to be recalibrated at Rohde & Schwarz service in order to comply with the specifications of the data sheet.

---

### 3.7.3 Bidirectional measurements 100 kHz to 8.5 GHz for R&S ZND

#### Option R&S ZND-K6

Software option R&S ZND-K6 enables bidirectional measurements for a R&S ZND with extended frequency range (i.e.with option R&S ZND-K1).

**Recalibration Required**

Although this is a software option, the R&S ZND has to be recalibrated at Rohde & Schwarz service in order to comply with the specifications of the data sheet.

### 3.7.4 Frequency Range Extension to 8.5 GHz for bidirectional R&S ZND

**Option R&S ZND-K8**

Increases the upper frequency limit of a bidirectional R&S ZND (i.e. equipped with R&S ZND-K5) from 4.5 GHz to 8.5 GHz.

**Recalibration Required**

Although this is a software option, the R&S ZND has to be recalibrated at Rohde & Schwarz service in order to comply with the specifications of the data sheet.

### 3.7.5 Time Domain Analysis

**Option R&S ZNC-K2 / R&S ZND-K2**

The network analyzer measures and displays complex S-parameters and other quantities as a function of the frequency. The measurement results can be filtered and mathematically transformed in order to obtain the time domain representation, which often gives a clearer insight into the characteristics of the DUT.

Time domain transforms can be calculated in band pass or low pass mode. For the latter the analyzer offers the impulse and step response as two alternative transformation types. A wide selection of windows can be used to optimize the time domain response and suppress sidelobes due to the finite sweep range. Moreover, it is possible to eliminate unwanted responses by means of a time gate and transform the gated result back into the frequency domain.

For a detailed discussion of the time domain transformation including many examples refer to the application note 1EZ44\_OE which is posted on the R&S internet.

#### 3.7.5.1 Chirp z-Transformation

The Chirp z-transformation that the analyzer uses to compute the time domain response is an extension of the (inverse) Fast Fourier Transform (FFT). Compared to the FFT, the number of sweep points is arbitrary (not necessarily an integer power of 2), but the computation time is increased by approx. a factor of 2. This increased computation time is usually negligible compared to the sweep times of the analyzer.

The following properties of the Chirp z-transformation are relevant for the analyzer settings:

- The frequency points must be equidistant.

- The time domain response is repeated after a time interval which is equal to  $\Delta t = 1/\Delta f$ , where  $\Delta f$  is the spacing between two consecutive sweep points in the frequency domain. For a sweep span of 4 GHz and 201 equidistant sweep points,  $\Delta f = 4 \text{ GHz}/200 = 2 \cdot 10^7 \text{ Hz}$ , so that  $\Delta t = 50 \text{ ns}$ .  $\Delta t$  is termed measurement range (in time domain) or unambiguous range.

Additional constraints apply if the selected Chirp z-transformation is a lowpass transformation.

### 3.7.5.2 Band Pass and Low Pass Mode

The analyzer provides two essentially different types of time domain transforms:

- **Band pass mode:** The time domain transform is based on the measurement results obtained in the sweep range between any set of positive start and stop values. The sweep points must be equidistant. No assumption is made about the measurement point at zero frequency (DC value). The time domain result is complex with a generally undetermined phase depending on the delay of the signal.
- **Low pass mode:** The measurement results are continued towards  $f = 0$  (DC value) and mirrored at the frequency origin so that the effective sweep range (and thus the response resolution) is more than doubled. Together with the DC value, the condition of equidistant sweep points implies that the frequency grid must be harmonic. Due to the symmetry of the trace in the frequency domain, the time domain result is harmonic.

See also [Chapter 3.7.5.4, "Harmonic Grid"](#), on page 112.

Two different types of response are available in low pass mode; see below.

**Table 3-10: Comparison of band pass and low pass modes**

Transform type	Band pass	Low pass
Advantages	Easiest to use: works with any set of equidistant sweep points	Higher response resolution (doubled) Includes information about DC value Real result Impulse and step response
Restrictions	No step response Undetermined phase	Needs harmonic grid
Use for...	Scalar measurements where the phase is not needed DUTs that don't operate down to $f = 0$ (e.g. pass band or high pass filters)	Scalar measurements where the sign is of interest DUT's with known DC value

#### Impulse and step response

In low pass mode, the analyzer can calculate two different types of responses:

- The impulse response corresponds to the response of a DUT that is stimulated with a short pulse.
- The step response corresponds to the response of a DUT that is stimulated with a voltage waveform that transitions from zero to unity.

The two alternative responses are mathematically equivalent; the step response can be obtained by integrating the impulse response:

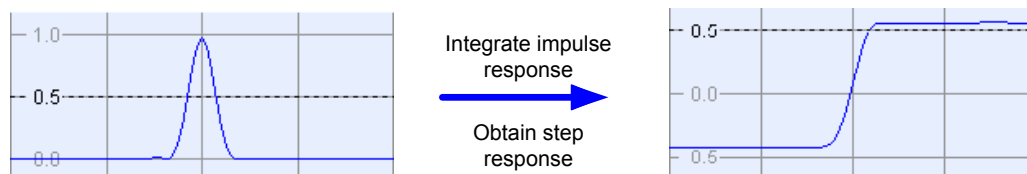

The step response is recommended for impedance measurements and for the analysis of discontinuities (especially inductive and capacitive discontinuities). The impulse response has an unambiguous magnitude and is therefore recommended for most other applications.

### 3.7.5.3 Windows in the Frequency Domain

The finite sweep range in a frequency domain measurement with the discontinuous transitions at the start and stop frequency broadens the impulses and causes side-lobes (ringing) in the time domain response. The windows offered in the "Define Transform" dialog can reduce this effect and optimize the time domain response. The windows have the following characteristics:

**Table 3-11: Properties of frequency windows**

Window	Sidelobe suppression	Relative impulse width	Best for...
No Profiling (Rectangle)	13 dB	1	–
Low First Sidelobe (Hamming)	43 dB	1.4	Response resolution: separation of closely spaced responses with comparable amplitude
Normal Profile (Hann)	32 dB	1.6	Good compromise between pulse width and sidelobe suppression
Steep Falloff (Bohman)	46 dB	1.9	Dynamic range: separation of distant responses with different amplitude
Arbitrary Sidelobes (Dolph-Chebyshev)	User defined between 10 dB and 120 dB	1.2 (at 32 dB sidelobe suppression)	Adjustment to individual needs; tradeoff between sidelobe suppression and impulse width

### 3.7.5.4 Harmonic Grid

A harmonic grid is formed by a set of equidistant frequency points  $f_i$  ( $i = 1 \dots n$ ) with spacing  $\Delta f$  and the additional condition that  $f_1 = \Delta f$ . In other words, all frequencies  $f_i$  are set to harmonics of the start frequency  $f_1$ .

If a harmonic grid, including the DC value ( $f = 0$ ), is mirrored to the negative frequency range, the result is again an equidistant grid.



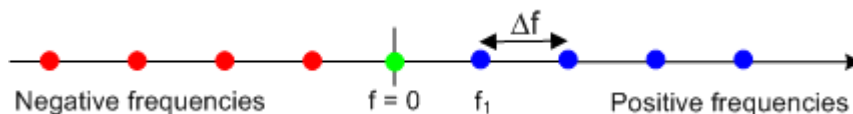

The point symmetry with respect to the DC value makes harmonic grids suitable for lowpass time domain transformations.

**Visualization of the harmonic grid algorithms**

The R&S ZNC/ZND provides three different algorithms for harmonic grid calculation. The three harmonic grids have the following characteristics:

- Keep "Stop Frequency and Number of Points" means that the stop frequency and the number of sweep points is maintained. The sweep points are re-distributed across the range between the minimum frequency of the analyzer and the stop frequency; the step width may be increased.

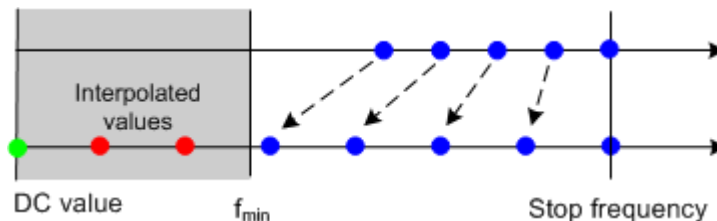

- Keep "Frequency Gap and Number of Points" means that the number of sweep points and their relative spacing is maintained. If the start frequency of the sweep is sufficiently above the f<sub>min</sub>, the entire set of sweep points is shifted towards lower frequencies so that the stop frequency is decreased.

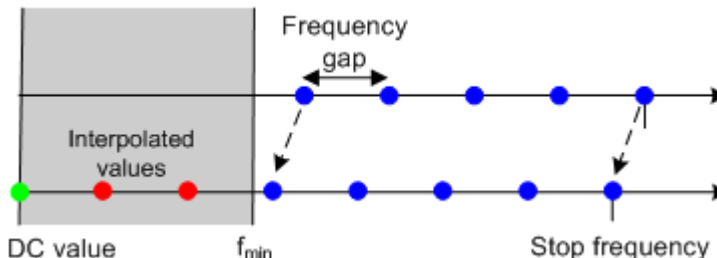

If the start frequency of the sweep is close to f<sub>min</sub>, then the sweep points may have to be shifted towards higher frequencies. If the last sweep point of the calculated harmonic grid exceeds the maximum frequency of the analyzer, then an error message is displayed, and another harmonic grid algorithm must be used.

- Keep "Stop Frequency and Approximate Frequency Gap" means that the stop frequency is maintained and the number of sweep points is increased until the range between f<sub>min</sub> and the stop frequency is filled. The frequency gap is approximately maintained.

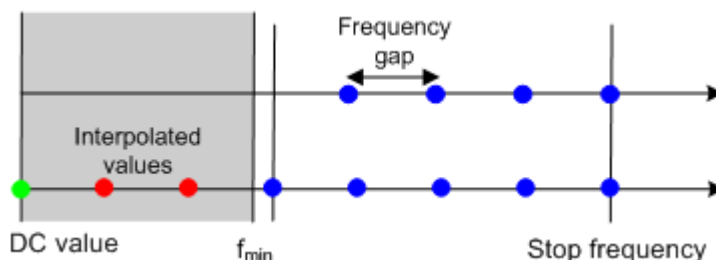

The figures above are schematic and do not comply with the conditions placed on the number of sweep points and interpolated/extrapolated values.



The harmonic grids can not be calculated for any set of sweep points. If the minimum number of sweep points is smaller than 5, then the interpolation/extrapolation algorithm for additional sweep points will not work. The same is true if the number of sweep points or stop frequency exceeds the upper limit. Besides, the ratio between the sweep range and the interpolation range between  $f = 0$  and  $f = f_{min}$  must be large enough to ensure accurate results. If the sweep range for the harmonic grid exceeds the frequency range of the current system error correction, a warning is displayed.

### Finding the appropriate algorithm

The three types of harmonic grids have different advantages and drawbacks. Note that for a bandpass transformation the grid parameters have the following effect:

- A wider sweep range (i.e. a larger bandwidth) increases the time domain resolution.
- A smaller frequency gap extends the unambiguous range.
- A larger number of points increases the sweep time.

With default analyzer settings, the difference between the grid types are small. The following table helps you find the appropriate grid.

Table 3-12: Properties of grid types

Grid type: Keep	Sweep time	Time domain resolution	Unambiguous range	Algorithm fails if...
Stop freq. and no. of points	➡	⬆	⬇	–
Freq. gap and no. of points	➡	➡	➡	Stop frequency beyond upper frequency limit
Stop freq. and approx. freq. gap	⬆	⬆	➡	Number of sweep points beyond limit

### 3.7.5.5 Time Gates

A time gate is used to eliminate unwanted responses that appear on the time domain transform. An active time gate acts on the trace in time domain as well as in frequency domain representation.

The properties of the time gates are analogous to the properties of the frequency domain windows. The following table gives an overview:

**Table 3-13: Properties of time gates**

Window	Sidelobe suppression	Passband ripple	Best for...
Steepest Edges (Rectangle)	13 dB	0.547 dB	Eliminate small distortions in the vicinity of the useful signal, if demands on amplitude accuracy are low
Steep Edges (Hamming)	43 dB	0.019 dB	Good compromise between edge steepness and sidelobe suppression
Normal Gate (Hann)	32 dB	0.032 dB	Good compromise between edge steepness and sidelobe suppression
Maximum Flatness (Bohman)	46 dB	0 dB	Maximum attenuation of responses outside the gate span
Arbitrary Gate Shape (Dolph-Chebyshev)	User defined between 10 dB and 120 dB	0.071 dB	Adjustment to individual needs; tradeoff between sidelobe suppression and edge steepness

### Time-Gated Frequency Domain Trace

The trace in the frequency domain depends on the state of the "Time Gate":

- If the gate is disabled, the frequency domain (FD) trace corresponds to the measured sweep results prior to the time-domain transformation.
- If the gate is enabled, the displayed frequency domain trace is calculated from the time domain (TD) trace which is gated and transformed back into the frequency domain.

The analyzer uses fixed "No Profiling (Rectangle)" window settings to transform the measured trace into time domain. The TD trace is gated using the selected time gate. The gated trace is transformed back into frequency domain using a "No Profiling (Rectangle)" window.

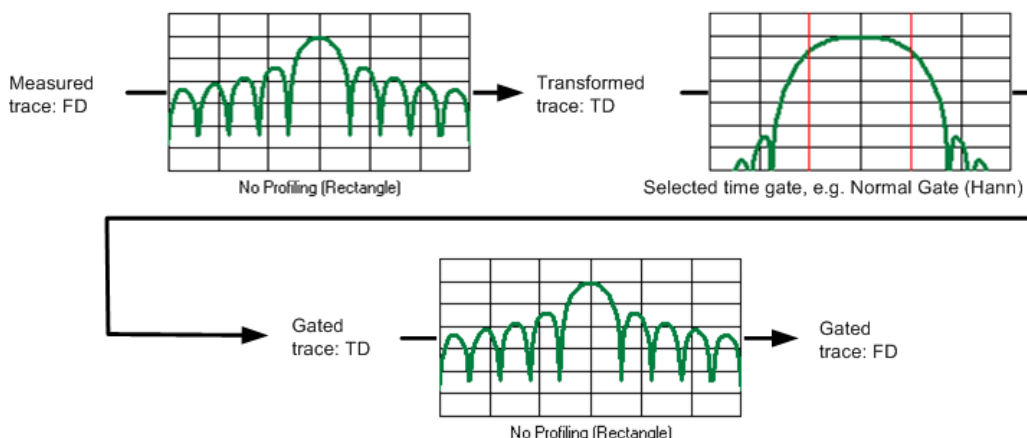

The shape, width and position of the time gate affect the gated frequency domain trace. The window type selection in the "Define Transform" dialog is ignored. The selected window is used again when the TD trace is displayed ("Time Domain: On").

The rectangular "No Profiling (Rectangle)" windows minimize numerical inaccuracies near the boundaries of the measured frequency span. In the limit where the effect of the time gate vanishes (e.g. a gate of type "Notch" and a very small width), the time gated trace is equal to the original measured trace.

### 3.7.6 Frequency Resolution 1 MHz

#### Option R&S ZNC/ZND-K19

This software option improves the frequency resolution of a R&S ZNC/ZND to 1 MHz.

### 3.7.7 GPIB Interface

#### Option R&S ZNC-B10 / R&S ZND-B10

This hardware option provides a GPIB bus connector according to standard IEEE 488 / IEC 625. The GPIB interface is used for remote control purposes and for the connection of external devices such as power meters. For details refer to [Chapter 9.1.3, "GPIB Interface"](#), on page 805.

### 3.7.8 Handler I/O

#### Option R&S ZN-B14

A network analyzer that is equipped with a Handler I/O (Universal Interface), can interact with an external part handler. The digital control signals on the interface connector indicate the possible start and the end of a measurement, as well as a global limit check result. Typically, the handler will insert the device to be tested into a test fixture, provide a trigger pulse to initiate the measurement, remove and replace the device after the measurement is complete and sort it into pass/fail bins. For details refer to [Chapter 9.1.4, "Universal Interface"](#), on page 808.

### 3.7.9 Additional Removable HD (R&S ZNC only)

#### Option R&S ZNC-B19 / R&S ZNC-B19\_Var08

Provides an additional removable HD:

- Order no. 1323.9503.02 is for instruments with controller IPS1; it comes with 32 bit versions of Windows 7 and the VNA firmware
- Order no. 1323.9503.08 is for instruments with controller IPS2; it comes with 64 bit versions of Windows 7 and the VNA firmware



- This hardware option is not available for the R&S ZND.
- A R&S ZNC with controller IPS1 (IPS2) can only run 32 bit (64 bit) versions of OS and FW.

### 3.7.10 Extended Power Range

#### Option R&S ZNC3-B22 / R&S ZND-K7

For the R&S ZNC hardware option R&S ZNC3-B22 reduces the minimum receive power down to -50 dBm.

For the R&S ZND software option R&S ZND-K7 enables an extended power range of -45 dBm to +3 dBm.

It is also required to manually configure AGC for a-waves (see [Manual Config...](#)).



#### R&S ZND: Recalibration Required

Although this is a software option for the R&S ZND, the instrument has to be recalibrated at Rohde & Schwarz service in order to comply with the specifications of the data sheet.

### 3.7.11 External Power Meters

The connection of an external power meter to the R&S ZNC/ZND can serve different purposes.

- Extended measurement functionality: Each external power meter represents an additional receive port. External generators increase the number of RF output signals of a DUT that the analyzer can measure simultaneously. They can also provide accurate results for signals at inaccurate or unknown frequencies. A typical example is a mixer measurement with an unknown LO signal (and therefore unknown IF output frequency).

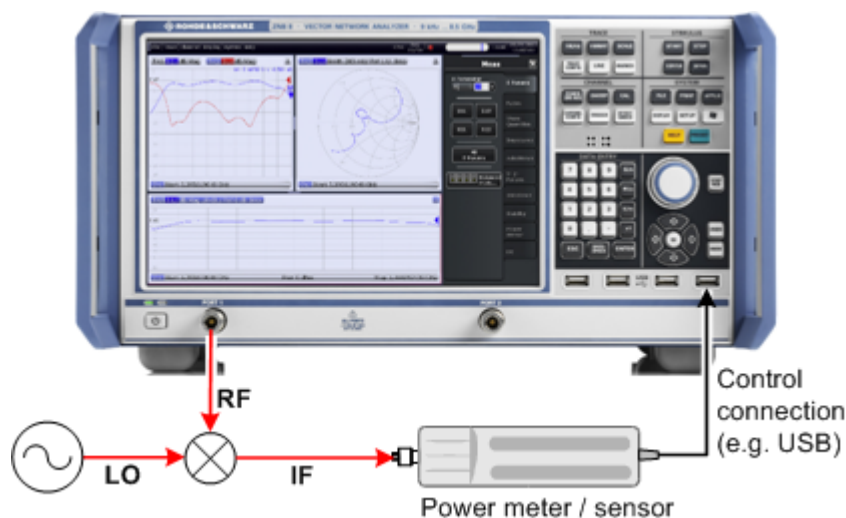

- Power calibration: An external power meter can measure the exact signal power at an arbitrary point in the test setup (reference plane) and thus provide the reference values for a power calibration. A typical example is a source power calibration for an arbitrary analyzer port.

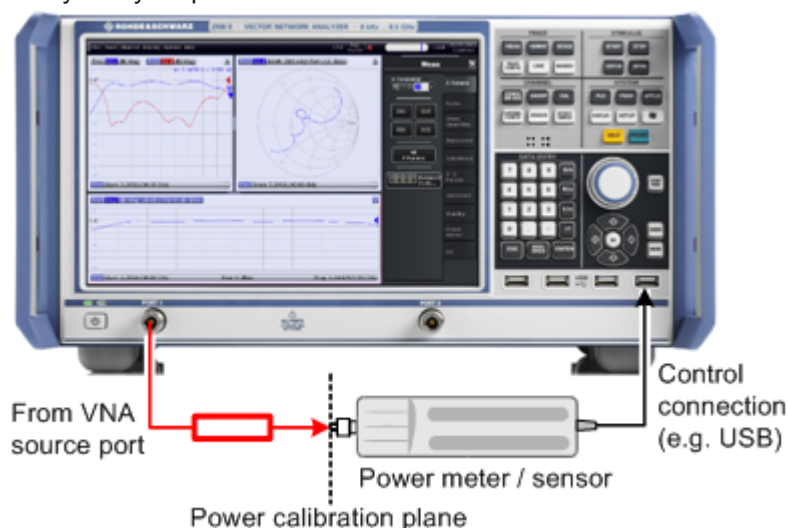

External power meters must be configured with their connection type and device address before they are available as additional receivers ("SYSTEM SETUP > External Devices > Power Meters"). Configured power meters appear in many control elements of the R&S ZNC/ZND, e.g. in the port configuration and in the power calibration dialogs.

### Zeroing

Zeroing calibrates the external power meter by adjusting its reading at zero signal power. For this purpose, the RF cable between the analyzer and the power sensor must be disconnected (see tips below!). R&S power sensors and power meters automatically detect the presence of any significant input power. This aborts zeroing and generates an error message. Zeroing can take a few seconds, depending on the power

meter model; refer to the documentation of your external power meter for more information.



#### **Repeat zeroing**

- During warm-up after switching on or connecting the instrument
- After a substantial change of the ambient temperature
- After fastening the power meter to an RF connector at high temperature
- After several hours of operation
- When very low-power signals are to be measured, e.g. less than 10 dB above the lower measurement limit.

---

A reset of the network analyzer does not affect the last zeroing result.

## 4 GUI Reference

This chapter explains all functions of the analyzer and their application. It is organized according to the menus of the Graphical User Interface (GUI).

The topics in this chapter can be called up directly using the HELP key or the Help buttons in the dialogs. A link at the end of each function description leads to the corresponding remote control command.

For a general overview of the analyzer's capabilities and their use refer to [Chapter 3, "Concepts and Features"](#), on page 11.

### 4.1 File Settings

The "File" softtool allows to work with recall sets and trace data.

**Access:** SYSTEM > FILE key or Ctrl + O

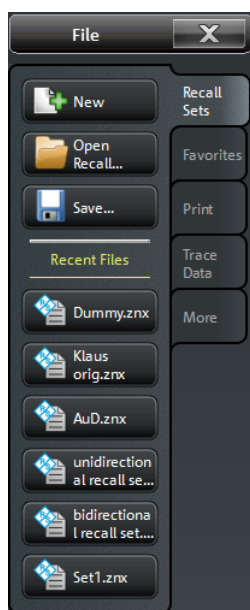

#### 4.1.1 File > Recall Sets

A recall set comprises a set of diagrams together with the underlying system, channel, trace and display settings. It can be stored to a VNA recall set file (\*.znx).





For background information see [Chapter 3.1.2, "Recall Sets"](#), on page 12.

#### 4.1.1.1 Basic Recall Set Functions

To create a recall set based on the current analyzer configuration, select [Save](#). To open an existing recall set, select [Open Recall](#).



If the memory consumption of the VNA is too high, new setups can only be created (via [New](#) or [Open Recall](#)) if the existing ones are closed. This is indicated by the following dialog:

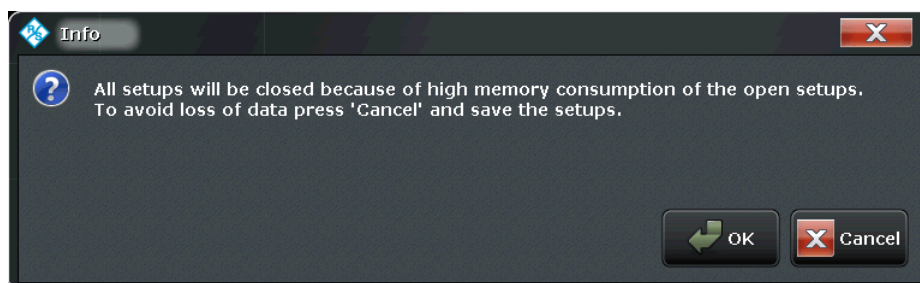

Run the Windows Task Manager to check the current memory consumption of the `Vna.exe` process and use the [Save](#) action to save unpersisted changes.

#### New

Creates a new recall set. The default names for recall sets are "Set1", "Set2" ... Recall sets are accessible via tabs in the diagram area:



**Tip:** To open an existing recall set, use "Open Recall...". To rename a setup, use "Save..."

Remote command:

MEMory:DEFine

### Open Recall

Loads an existing recall set from a file.

Opens the [Open dialog](#) that allows you to select the file from all VNA recall set files (\*.znx) stored on the file system.

Remote command:

MMEMory:LOAD:STATe

### Save

Saves the active recall set to a file (\*.znx).

Displays the ["Save dialog"](#) on page 39 that allows you to specify a file name and location for the recall set file.

Remote command:

MMEMory:STORe:STATe

### Recent Files

The buttons are labelled with the last recall sets which were stored in the current or in previous sessions. They open the corresponding recall set.

## 4.1.2 File > Favorites

The "Favorites" tab allows to manage a list of favorite recall sets.



A favorite is actually a path to the related recall set, i.e.

- if the recall set is modified, then the modified recall set is loaded the next time the favorite is selected

- if the recall set is moved or deleted, the corresponding favorite is broken

The firmware can manage up to 6 favorites. New favorites are always created at the topmost spare position in the favorites list. If the list is complete (i.e. if there are no more spare positions), new favorites can only be added after existing ones were removed

#### Add Active Recall Set

Adds the active recall set to the list of favorites.

This button is only active if the current setup was loaded from or saved to a recall set.

#### Import

Opens a file browser that allows you to add an arbitrary recall set to the favorites list.

Remote command:

`MMEMoRY:FAVORite<FavId>`

#### Favorites

Select one of the active buttons to open the corresponding recall set.

#### Favorites combo-box / Remove

Use the "Favorites" combo-box to select the favorite to be removed from the list, then select "Remove"

### 4.1.3 File > Print

The "File > Print" buttons allow to send the active recall set (i.e. the contents of the active diagrams) to an external printer, to a file or to the clipboard.

**Access:** SYSTEM > PRINT key or Ctrl + P

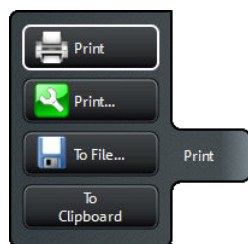

#### Print (<Printer>)

Prints the active recall set using the current printer and printer settings.

Remote command:

The `HCOPY . . .` commands provide the printer settings; see [Chapter 6.3.8, "HCOPY Commands"](#), on page 536.

`HCOPY[:IMMEDIATE]` initiates printing.

#### Print...

The "Printer Setup" dialog specifies how the active recall set is printed. Printer options are specified in three tabs. The lower part of the diagram shows a preview of the print.

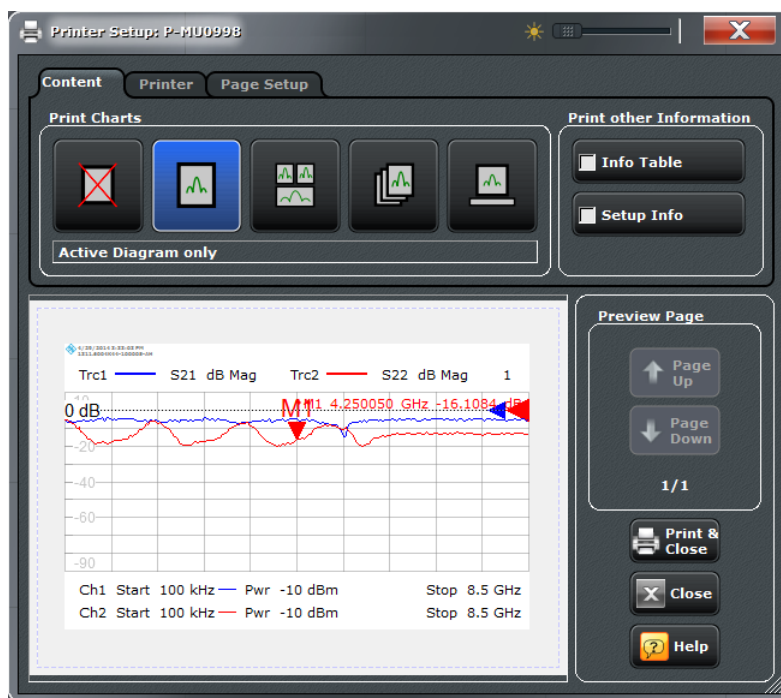

#### Content ← Print...

The selected item in the "Print Charts" group specifies how the active recall set is printed. Currently the following options are offered: "No Diagram at all", "Active Diagram only", "All diagrams on one page", "All diagrams on their own page" and "Hard copy of the diagram". The latter is the new print option which preserves colors and layout.

If selected in the "Print other information" group, the content of the "Info Table" (see ["Info Table / Position"](#) on page 327) and/or "Setup Info" (see [Chapter 4.6.3.1, "Setup"](#), on page 342) is printed on additional pages.

Remote command:

The `HCOPY...` commands provide the printer settings; see [Chapter 6.3.8, "HCOPY Commands"](#), on page 536.

#### Printer ← Print...

The "Printer" settings select one of the installed printers and specify printer options. Printers can be installed using the "Start > Control Panel > Hardware and Sound > Devices and Printers" menu in the Windows® "Control Panel".

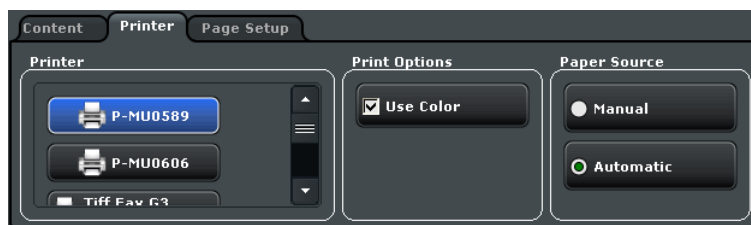

Remote command:

The `HCOPY...` commands provide the printer settings; see [Chapter 6.3.8, "HCOPY Commands"](#), on page 536.

**Page Setup ← Print...**

The "Page Setup" settings are visualized in the preview page in the lower part of the dialog.

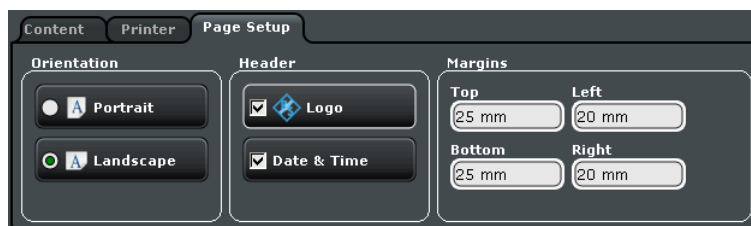

**Tip:** The printer settings are not affected by a preset of the R&S ZNC/ZND. Use the "Remote" tab in the "System Configuration" dialog ("SYSTEM > SETUP > Setup > System Config...") to restore default settings.

Remote command:

The `HCOPY...` commands provide the printer settings; see [Chapter 6.3.8, "HCOPY Commands"](#), on page 536.

**To File...**

The "Save Image" dialog selects a file and file format to store the current diagrams. See also ["Save dialog"](#) on page 39.

Remote command:

`HCOPY:DESTINATION`

**To Clipboard**

Copies the current diagram to the clipboard from where you can paste it into another application.

**4.1.4 File > Trace Data**

Imports and exports trace data. The settings are identical with the "TRACE > TRACE CONFIG > Trace Data" settings; see [Chapter 4.2.4, "Trace Config Settings"](#), on page 162.

**4.1.5 File > More**

The "File > More" buttons load simulation data or close the VNA application.

**Access:** SYSTEM > FILE key or Ctrl + O



**Load Simulation Data...**

Imports previously stored trace data into the active diagram. The analyzer opens a dialog box to select the file from all trace files (\*.s?p, \*.csv, \*.dat) stored on the file system; see "Open dialog" on page 38. The opened trace replaces the active trace.

**Exit**

Saves the active recall set and ends the analyzer session. The active recall set is automatically recalled when the analyzer application is re-started.

**Tip:** This button is equivalent to the "Close" command on the application "Control" menu (see [Chapter 4.9, "Control Menu"](#), on page 357) and to the close icon  in the title bar.

## 4.2 Trace Settings

The "Trace" menu provides all trace settings, limit check settings, and the marker functions including marker search.

**Background information**

Refer to the following sections:

- [Chapter 3.1.3, "Traces, Channels and Diagrams"](#), on page 12
  - [Chapter 3.1.3.1, "Trace Settings"](#), on page 13
  - [Chapter 3.1.4, "Sweep Control"](#), on page 14
- 

### 4.2.1 Meas Settings

The "Meas" functions select the measured and displayed results.

**Background information**

For a detailed description of all measurement results of the R&S ZNC/ZND refer to [Chapter 3.3, "Measurement Results"](#), on page 48.

---

**Efficient trace handling**

To select a result and display it as a trace, you can simply drag and drop the corresponding button into a diagram area. See also section "Handling Diagrams, Traces, and Markers" in the Help or in the "Getting Started" guide.

---

**Port activation on demand**

If a requested result involves disabled ports, but could be calculated if those ports were configured as single-ended ports with "logical port number = physical port number", then the required logical port configuration is performed automatically.

E.g. with P1 assigned to L1 and P2 disabled, S21 could be measured if P2 would be assigned to L2.

At the GUI, buttons representing results that require such an implicit logical port configuration ("S21 " in the example above), are labeled with yellow font color.

Currently, port activation on demand is supported for the following result types:

- S-parameters
- Converted impedances and admittances
- Y- and Z-parameters
- Imbalances and common mode rejection ratios

#### 4.2.1.1 Meas > S-Params

Selects S-parameters as measured quantities. Supports [Port activation on demand](#).



#### Background information

Refer to [Chapter 3.3.1, "S-Parameters"](#), on page 48.

**Access:** TRACE > MEAS key or Alt + Shift + A



left = R&S ZNC or bidirectional R&S ZND  
right = unidirectional R&S ZND

Some of the softkeys in the "S-Params" tab open dialogs.

- see [Chapter 4.2.1.2, "S-Parameter Wizard"](#), on page 129
- see [Chapter 4.2.1.3, "Balanced Ports Dialog"](#), on page 132



If the "Fixture Simulator" is disabled for the related channel (see ["Fixture Simulator"](#) on page 298), the button in the "Balanced Ports" section is inactive (greyed out).

### S-Parameter

Selects a scattering parameter (S-parameter) as measured quantity for the active trace.

The S-parameters are the basic measured quantities of a network analyzer. They describe how the DUT modifies a signal that is transmitted or reflected in forward or reverse direction. For background information see [Chapter 3.3.1, "S-Parameters"](#), on page 48.

Single-ended (unbalanced) S-parameters are referred to as  $S_{\langle out \rangle \langle in \rangle}$ , where  $\langle out \rangle$  and  $\langle in \rangle$  denote the output and input **logical** port numbers, respectively.

In presence of balanced ports, standard S-parameters are defined in the form  $S_{\langle m\_out \rangle \langle m\_in \rangle \langle out \rangle \langle in \rangle}$ , where output mode  $\langle m\_out \rangle$  and input mode  $\langle m\_in \rangle$  can be one of

- d (differential, balanced)
- c (common, balanced)
- s (single-ended, unbalanced)

It is also possible to display "raw" single-ended S-parameters within the same channel: after setting the S-Parameter type to "S" any pair of (used) **physical** ports may be selected.

**Note:** For a unidirectional R&S ZND (see [Chapter 3.1.4.2, "R&S ZND: Unidirectional vs. Bidirectional Operation"](#), on page 16) the reverse direction cannot be measured. Hence  $S_{12}$ ,  $S_{22}$  and balanced measurements are not available.

Remote command:

```
CALCulate<Ch>:PARAmeter:MEASure
```

```
CALCulate<Ch>:PARAmeter:MEASure:SENDEd
```

```
CALCulate<Ch>:PARAmeter:SDEFine
```

```
CALCulate<Ch>:PARAmeter:SDEFine:SENDEd
```

### $S_{\langle out \rangle \langle in \rangle}$ (softkeys)

Selects one of the four elements of the standard 2-port scattering matrix (S-parameters) as a measured quantity for the active trace.

The S-parameters are the basic measured quantities of a network analyzer. They describe how the DUT modifies a signal that is transmitted or reflected in forward or reverse direction. S-parameters are expressed as  $S_{\langle out \rangle \langle in \rangle}$ , where  $\langle out \rangle$  and  $\langle in \rangle$  denote the output and input port numbers of the DUT.

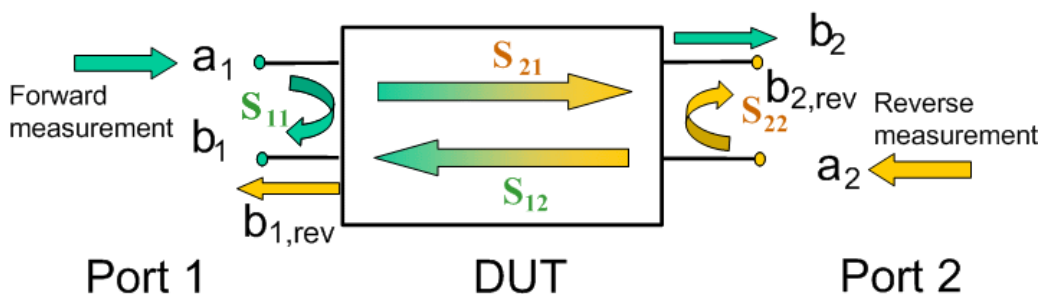

**Note:** For a unidirectional R&S ZND (see [Chapter 3.1.4.2, "R&S ZND: Unidirectional vs. Bidirectional Operation"](#), on page 16) the reverse direction ( $S_{12}$ ,  $S_{22}$ ) cannot be measured.



Remote command:

```
CALCulate<Ch>:PARAmeter:MEASure "<Trace_Name>", "S11" | "S12" |  
"S21" | "S22"
```

Create new trace and select trace name and measurement parameter:

```
CALCulate<Ch>:PARAmeter:SDEFine "<Trace_Name>", "S11" | "S12" |  
"S21" | "S22"
```

### All S-Params

Creates  $n^2$  diagrams (for an  $n$ -port vector network analyzer) and displays the full set of S-parameters, one in each diagram. The diagrams are arranged as an  $(n \times n)$  matrix. The reflection coefficients  $S_{ii}$  appear in the diagrams on the main diagonal, the transmission coefficients  $S_{ij}$  ( $i \neq j$ ) occupy the other diagrams. Reflection coefficients are displayed in Smith diagrams; transmission coefficients in Cartesian diagrams with logarithmic ("dB mag") scale.

See also: [Format Settings](#)

**Note:** For a unidirectional R&S ZND (see [Chapter 3.1.4.2, "R&S ZND: Unidirectional vs. Bidirectional Operation"](#), on page 16) "All S-Params" is limited to  $S_{11}$  and  $S_{21}$ , whose diagrams are presented one beneath the other.

Remote command:

```
CALCulate<Ch>:PARAmeter:SDEFine  
CALCulate<Ch>:PARAmeter:DEFine:SGRoup
```

#### 4.2.1.2 S-Parameter Wizard

The "S-Parameter Wizard" dialog consists of a series of dialogs providing the settings for a standard two-port S-parameter measurement in a frequency sweep.

**Access:** E.g. TRACE > MEAS > S-Params > S-Param Wizard ...

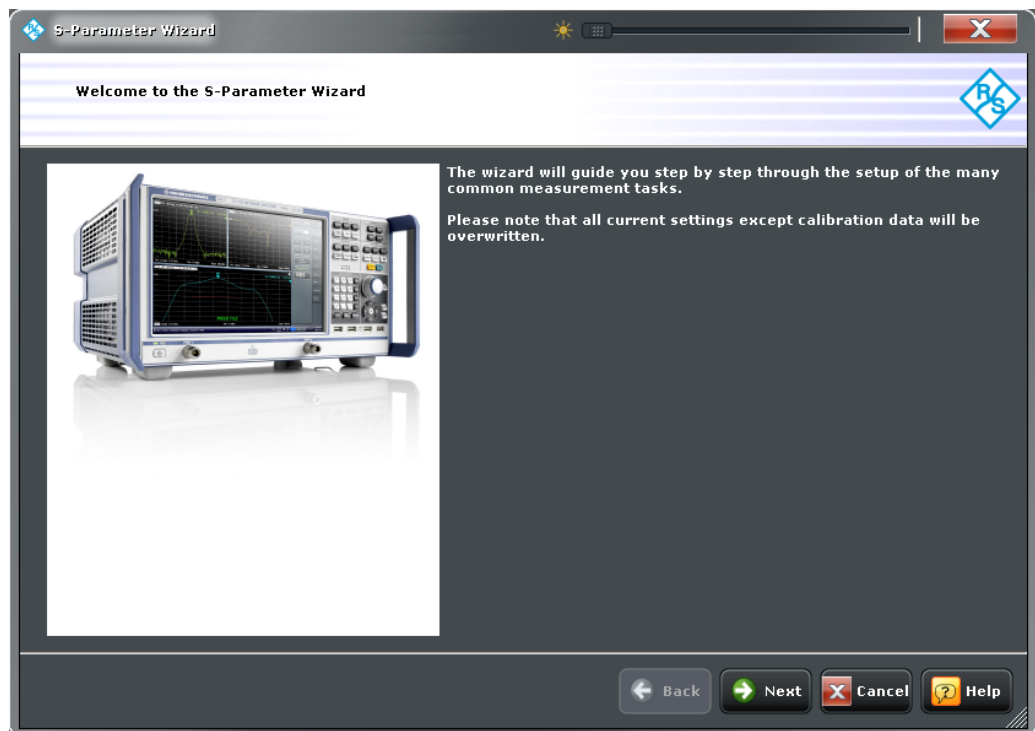

The measurement comprises the following stages:

1. **Select the test setup**

Choose the port setup of the analyzer according to the port configuration of your DUT and connect the DUT to the selected analyzer ports. This step corresponds to the "Predefined Configs" tab of the "Balanced Ports" dialog; see "[Predefined Configs](#)" on page 132.

2. **Define port impedances**

Assign reference impedances to all physical and balanced test ports selected in the previous step. The reference impedances can be complex. This step corresponds to the "Reference Impedance" tab of the "Balanced Ports" dialog; see "[Predefined Configs](#)" on page 132.

**Tip:** The default reference impedance of the physical analyzer ports is  $Z_0 = 50 \Omega$ . The default reference impedances for balanced ports are derived hereof. You do not need to change these value unless you want to renormalize the port impedances; see [Chapter 3.3.6, "Reference Impedances"](#), on page 60.

**Note:** For a unidirectional R&S ZND (see [Chapter 3.1.4.2, "R&S ZND: Unidirectional vs. Bidirectional Operation"](#), on page 16) balanced measurements are not supported.

3. **Select the measurement parameters and the diagram areas**

Choose an S-parameter or a group of S-parameters to be measured and displayed. The measurement parameters are displayed in separate diagram areas: Cartesian diagram areas are used for transmission S-parameters, Cartesian or Smith diagrams for reflection parameters. The selections to be made depend on the test setup selected in the previous stage.

**Tip:** In case of an error in a previous stage, you can always use the "Back" button and correct your settings.

4. **Select the sweep settings**

Choose the frequency range and the number of measurement points per sweep. The sweep range is defined by two values (start and stop frequency or center frequency and span). The measurement points are equidistant across the sweep range. Increasing the number of points also increases the measurement time per single sweep.

5. **Select the measurement bandwidth and source power**

Choose a typical measurement bandwidth and one of three typical source power values. A smaller measurement bandwidth increases the dynamic range but slows down the measurement. A smaller source power protects the input port of the analyzer from being overdriven, especially if an active DUT with high gain is measured.

**Note:**

The predefined bandwidths and source powers have been selected according to the following criteria:

- The large measurement bandwidth ("Fast Sweep") ensures that the noise of a  $S_{21}$  trace at minimum source power and 0 dB attenuation is smaller than 0.1 dB.
- The default source power for a passive DUT ensures that the analyzer receiver is in its linear range (no compression) if a passive DUT with 0 dB attenuation is measured. The default source powers for active DUTs ensure no compression if an active DUT with 20 dB or 40 dB gain is measured. If the actual gain of the DUT is more than 50 dB, then the default source power of -40 dB is still too high and needs to be changed after finishing the wizard.

6. **Perform a calibration (optional)**

Call the calibration wizard and perform a calibration. For a R&S ZNC or a bidirectional R&S ZND the default calibration type is a full two-port (TOSM) calibration; calibration can also be performed automatically (if a calibration unit is available). For a unidirectional R&S ZND (see [Chapter 3.1.4.2, "R&S ZND: Unidirectional vs. Bidirectional Operation"](#), on page 16) the default calibration type is a one path two ports calibration; automatic calibration is not supported.

**Tip:**

You can skip the calibration step (select "Finish now without Calibration") if one of the following applies:

- A valid calibration is already assigned to the active channel
- You want to apply a valid calibration stored in the cal pool.
- You don't want to use a calibration, e.g. because the factory calibration is accurate enough for your measurement.



**Instrument reset**

In order to obtain a predictable result the measurement wizard has to reset all settings except the current calibration data. Store your recall set if you don't want to lose the current configuration.

### 4.2.1.3 Balanced Ports Dialog

The "Balanced Ports" dialog selects a balanced port configuration and defines reference impedances for the balanced ports. Selecting a balanced port configuration means that one or more pairs of physical test ports are combined to form logical (balanced) ports.

Measurements do not necessarily require all of the physical and logical ports of the network analyzer. To save measurement time, it is recommended to specify the ports that are not used in the current test setup as "Unused" ports. Unused ports will not be considered for the calculation of mixed mode, Z- and Y-parameters.



#### Background information

Refer to the following sections:

- [Chapter 3.3.5, "Unbalance-Balance Conversion"](#), on page 57
- [Chapter 3.3.5.1, "Balanced Port Configurations"](#), on page 58
- [Chapter 3.3.6, "Reference Impedances"](#), on page 60

#### Predefined Configs

The "Predefined Configs" tab of the "Balanced and Measured Ports" dialog provides the most commonly used balanced port configurations for the analyzer.

**Access:** E.g. TRACE > MEAS > S-Params > Balanced Ports...

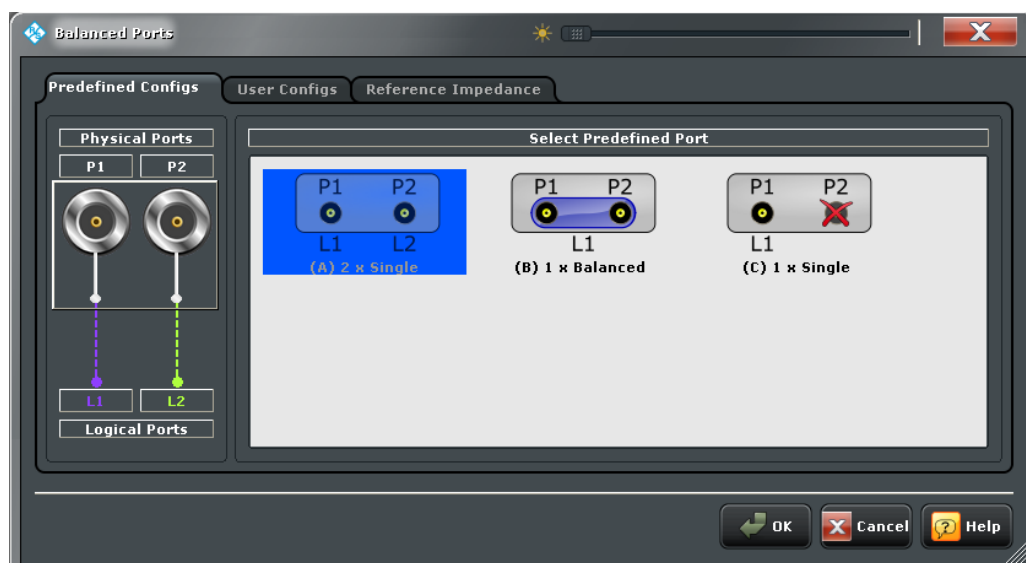

The port configurations are arranged in a scrollable list. The resulting port number assignment is shown on the left-hand side of the "Predefined Configs" tab.

- For a single-ended port, the diagram shows a single line between the physical test port and the logical port.
- For a balanced port, two physical ports are combined to form a single logical port.
- For unused ports, the physical port is crossed out; no logical port number is assigned.



For a unidirectional R&S ZND (see [Chapter 3.1.4.2, "R&S ZND: Unidirectional vs. Bidirectional Operation"](#), on page 16) the balanced port scenario (B) is not available.

### Select Predefined

List of predefined port configurations.

For a R&S ZNC or bidirectional R&S ZND three configurations are possible: Two single-ended ports, one balanced port, only port 1 in use (single-ended reflection measurement). For a unidirectional R&S ZND (see [Chapter 3.1.4.2, "R&S ZND: Unidirectional vs. Bidirectional Operation"](#), on page 16) the balanced port configuration is not available.

Remote command:

```
SOURce<Ch>:LPORt<LogPt>
SOURce<Ch>:LPORt<LogPt>:CLEAr
```

### User Config

The "User Config" tab of the "Balanced Ports" dialog defines a new balanced port configuration.

**Access:** E.g. TRACE > MEAS > S-Params > Balanced Ports...



For a unidirectional R&S ZND (see [Chapter 3.1.4.2, "R&S ZND: Unidirectional vs. Bidirectional Operation"](#), on page 16) this tab is not available.

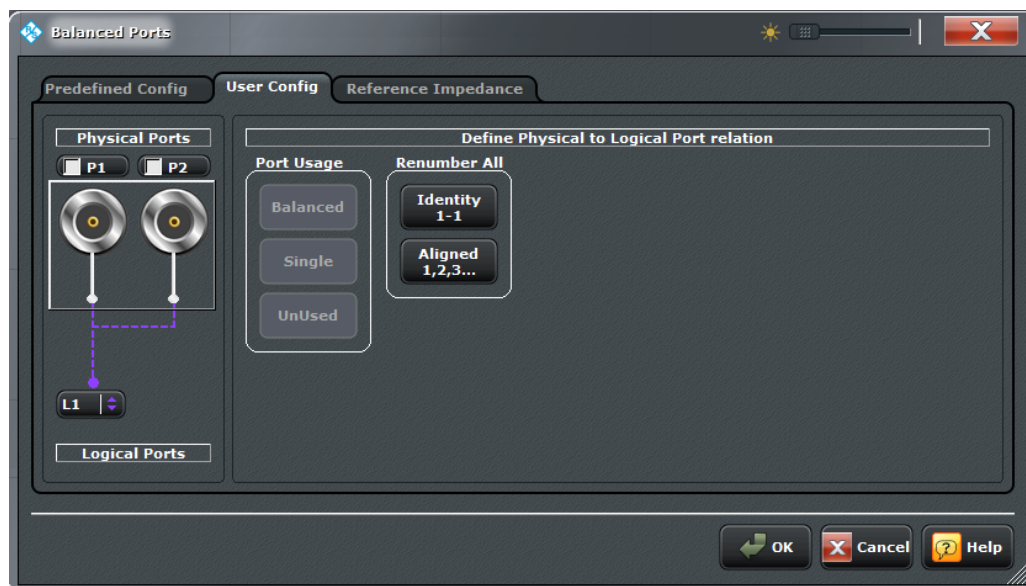

### Physical/Logical Ports

Allows to freely assign logical port numbers to balanced and single-ended ports.

Remote command:

```
SOURce<Ch>:LPORt<LogPt>
```

### Define Physical to Logical Port Relation

Allows to define balanced, single-ended, and unused ports. The two physical ports of the analyzer can be combined into a balanced port.

Furthermore, provides functions for renumbering the logical ports.

- To define a balanced port, select two physical ports and tap "Balanced".
- To dissolve a balanced port, select it and tap "Single".
- To exclude a physical port from the measurement, select the port and tap "Unused".
- To number the logical ports in line with the physical ports, tap "Identity 1-1"
- To number the logical ports consecutively from left to right, tap "Aligned 1,2,3..."

Remote command:

```
SOURce<Ch>:LPORT<LogPt>:CLEar
```

```
SOURce<Ch>:GROup<Grp>
```

```
SOURce<Ch>:GROup<Grp>:PORTs
```

```
SOURce<Ch>:GROup<Grp>:CLEar
```

### Reference Impedance

The "Reference Impedance" tab of the "Balanced Ports" dialog (re-)defines the port impedances of the logical ports.



### Background information

Refer to [Chapter 3.3.6, "Reference Impedances"](#), on page 60.

**Access:** E.g. TRACE > MEAS > S-Params > Balanced Ports...

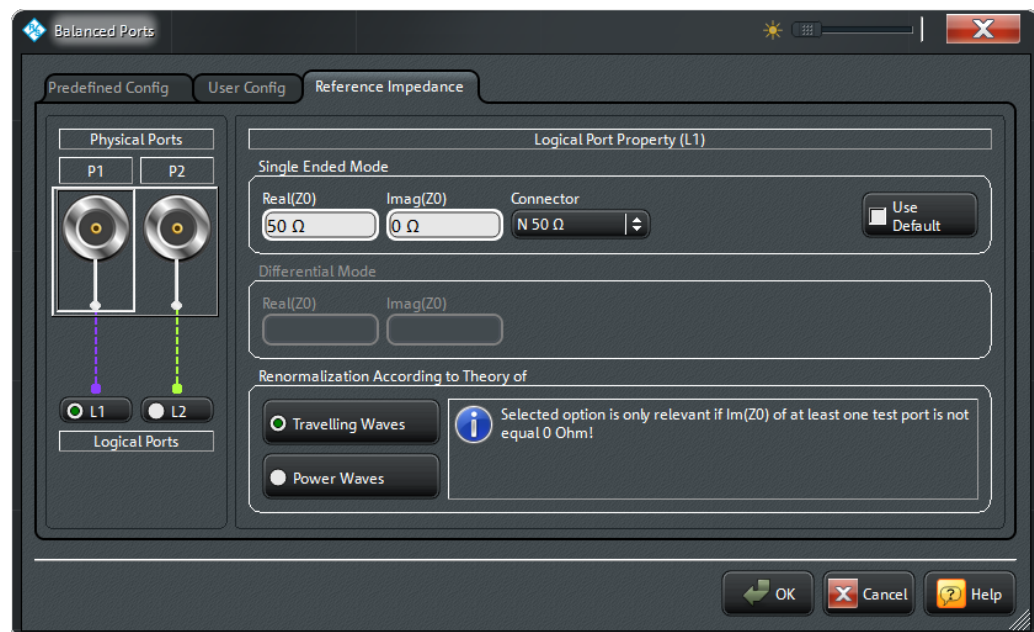

The default reference impedance for a physical port is equal to the reference impedance of the connector type assigned to the port but can be defined as an arbitrary complex value (renormalization of port impedances). By changing the reference impe-

dance, it is possible to convert the measured values at 50 Ω (75 Ω) into values at arbitrary port impedances.

For balanced ports it is possible to define separate complex reference impedances for differential and for common mode.

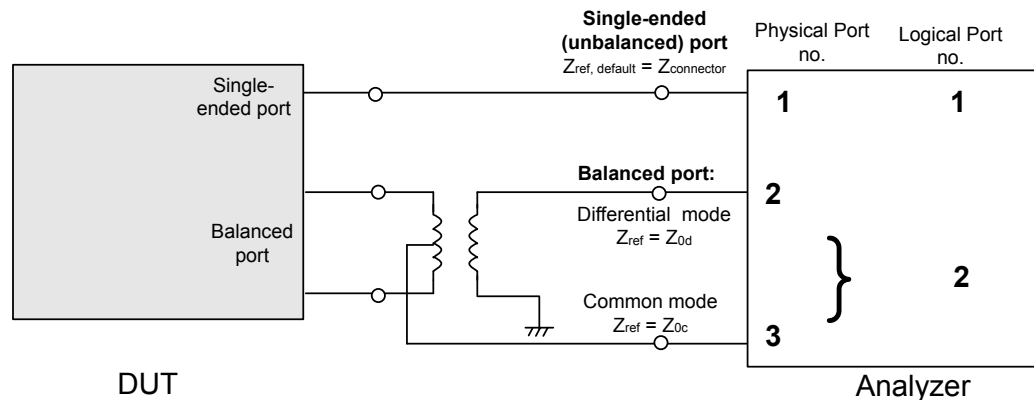

For a unidirectional R&S ZND (see [Chapter 3.1.4.2, "R&S ZND: Unidirectional vs. Bidirectional Operation"](#), on page 16) balanced measurements are not available.

### Single Ended Mode / Common Mode / Differential Mode

Defines arbitrary reference impedances.

"Single Ended Mode" is available for single-ended logical ports only, "Common Mode" and "Differential Mode" impedances for balanced ports only.

The default values for the balanced port reference impedances are derived from the (real) default reference impedance  $Z_0 = 50 \Omega$  of the (single-ended) physical analyzer ports:

- The default value for the differential mode is  $Z_{0d} = 100 \Omega = 2 \cdot Z_0$ .
- The default value for the common mode is  $Z_{0c} = 25 \Omega = Z_0/2$ .

**Note:** For a unidirectional R&S ZND (see [Chapter 3.1.4.2, "R&S ZND: Unidirectional vs. Bidirectional Operation"](#), on page 16) only single ended mode is available.

Remote command:

```
[SENSe<Ch>:] PORT<PhyPt>: ZREFerence
```

```
[SENSe<Ch>:] LPORT<LogPt>: ZCOMmon
```

```
[SENSe<Ch>:] LPORT<LogPt>: ZDIFferent
```

### Connector

Allows to specify the connector type of the related physical port.

Remote command:

```
[SENSe<Ch>:] CORRection: COLLect: CONNectiOn<PhyPt>
```

### Use Default

Allows to toggle between default and renormalized port impedance(s) for the selected logical port and connector type.

Remote command:

```
[SENSe<Ch>:] LPORT<LogPt>:ZDEFault[:STATe]
```

**Renormalization according to Theory of**

Selects the waveguide circuit theory for renormalization. The conversion formula of both theories differ only if the reference impedance of at least one test port has a non-zero imaginary part.

Refer to [Chapter 3.3.6, "Reference Impedances"](#), on page 60.

Remote command:

```
CALCulate<Chn>:TRANSform:IMPedance:RNORmal on page 484
```

**4.2.1.4 Meas > Ratios**

Selects ratios of wave quantities as measured quantities.



**Background information**

Refer to [Chapter 3.3.4, "Wave Quantities and Ratios"](#), on page 54.

**Access:** TRACE > MEAS key or Alt + Shift + A

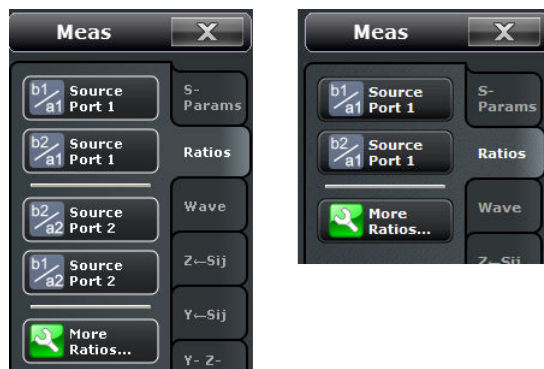

left = R&S ZNC or bidirectional R&S ZND  
right = unidirectional R&S ZND

**b<i> / a<j> Source Port <j> (softkeys)**

Selects predefined complex ratios of the standard 2-port wave quantities  $a_1$ ,  $a_2$ ,  $b_1$ , and  $b_2$ .

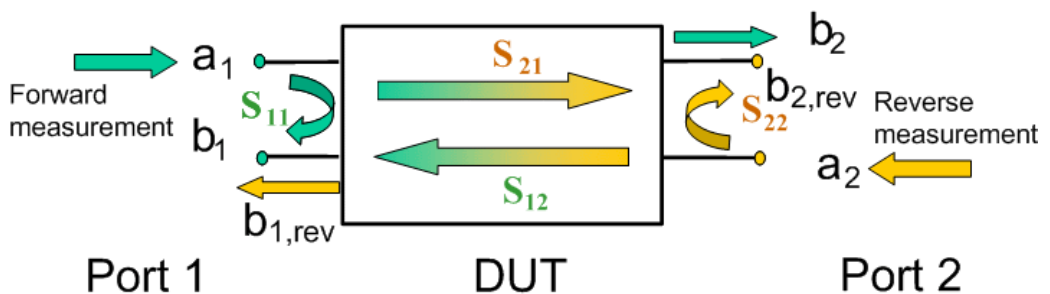



The predefined wave quantities can all be obtained with the same test setup, where a 2-port DUT is connected between the analyzer ports 1 and 2. The stimulus signal is provided by the analyzer port 1 or 2 ("Source Port").

The predefined wave quantities correspond to the 2-port S-parameters:

- "b1/a1 Source Port 1" is the ratio of the wave quantities  $b_1$  and  $a_1$ , measured at port 1. This ratio corresponds to the S-parameter  $S_{11}$  (input reflection coefficient).
- "b2/a1 Source Port 1" is the ratio of the wave quantities  $b_2$  and  $a_1$  and corresponds to the S-parameter  $S_{21}$  (forward transmission coefficient).
- "b2/a2 Source Port 2" is the ratio of the wave quantities  $b_2$  and  $a_2$ , measured at port 2. This ratio corresponds to the S-parameter  $S_{22}$  (output reflection coefficient).
- "b1/a2 Source Port 2" is the ratio of the wave quantities  $b_1$  and  $a_2$  and corresponds to the S-parameter  $S_{12}$  (reverse transmission coefficient).

The analyzer can also measure arbitrary ratios for other source ports; see "[More Ratios](#)" on page 137.

**Tip:** In the trace list the source port is indicated in brackets. "b2/a1(P1)" denotes the ratio  $b_2/a_1$  with source port 1.

**Note:** For a unidirectional R&S ZND (see [Chapter 3.1.4.2, "R&S ZND: Unidirectional vs. Bidirectional Operation"](#), on page 16) ratios for source port 2 are not available.

Remote command:

```
CALCulate<Ch>:PARAMeter:MEASure "<Trace_Name>", "B2/A1" | ...
```

Create new trace and select trace name and measurement parameter:

```
CALCulate<Ch>:PARAMeter:SDEFine "<Trace_Name>", "B2/A1" | ...
```

### More Ratios

Opens a dialog to select arbitrary ratios of wave quantities.

#### 4.2.1.5 More Ratios (Dialog)

The "More Ratios" dialog allows to select arbitrary ratios between wave quantities  $b_i$ ,  $a_j$  as measured quantity. The ratios can be calculated with arbitrary source port and different detector settings.



#### Background information

Refer to the following sections:

- [Chapter 3.3.4.1, "Wave Quantities"](#), on page 54
- [Chapter 3.3.4.2, "Ratios"](#), on page 55

**Access:** TRACE > MEAS > Ratios > More Ratios...

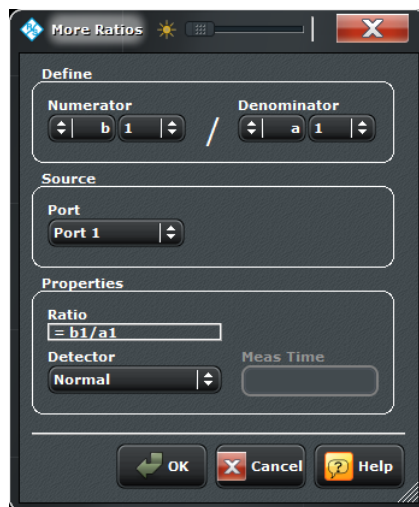

For a unidirectional R&S ZND (see [Chapter 3.1.4.2, "R&S ZND: Unidirectional vs. Bidirectional Operation"](#), on page 16) only port 1 may serve as source and hence the corresponding control is disabled.

The notation for ratios follows the usual scheme of the vector network analyzer:

- The a-waves are the outgoing/transmitted waves at the analyzer's test ports.
- The b-waves are the incoming/measured waves.
- The source port for the stimulus signal must be specified in addition.
- The port number range covers all test ports of the analyzer.

#### Numerator

Selects the type (left pull-down list) and the port number assignment (right pull-down list) of the wave that forms the numerator of the ratio.

Remote command:

```
CALCulate<Ch>:PARAMeter:MEASure "<Trace_Name>", "B2/A1" | ...
```

Create new trace and select trace name and measurement parameter:

```
CALCulate<Ch>:PARAMeter:SDEFine "<Trace_Name>", "B2/A1" | ...
```

#### Denominator

Selects the type (left pull-down list) and the port number assignment (right pull-down list) of the wave that forms the denominator of the ratio.

Remote command:

```
CALCulate<Ch>:PARAMeter:MEASure "<Trace_Name>", "B2/A1" | ...
```

Create new trace and select trace name and measurement parameter:

```
CALCulate<Ch>:PARAMeter:SDEFine "<Trace_Name>", "B2/A1" | ...
```

#### Port

The source port for the stimulus signal: "Port 1" or "Port 2" for a R&S ZNC or a bidirectional R&S ZND. For a unidirectional R&S ZND (see [Chapter 3.1.4.2, "R&S ZND: Unidirectional vs. Bidirectional Operation"](#), on page 16) only port 1 may serve as source and hence this control is disabled.

Remote command:

```
CALCulate<Ch>:PARAmeter:MEASure "<Trace_Name>", "<Ratio>"
```

Create new trace and select trace name and measurement parameter:

```
CALCulate<Ch>:PARAmeter:SDEFine "<Trace_Name>", "<Ratio>"
```

(the parameter name <Ratio> can also contain the source port)

### Detector

Selects the algorithm that is used to calculate the displayed measurement points from the raw data.

For details refer to: [Chapter 3.3.4.3, "Detector Settings"](#), on page 56.

Remote command:

```
CALCulate<Ch>:PARAmeter:MEASure "<Trace_Name>", "<Ratio>"
```

```
CALCulate<Ch>:PARAmeter:SDEFine "<Trace_Name>", "<Ratio>"
```

(the parameter name <Ratio> can also contain the detector)

```
[SENSe<Ch>:]SWEep:DETECTOR:TIME
```

#### 4.2.1.6 Meas > Wave

Selects wave quantities as measured quantities.



### Background information

Refer to [Chapter 3.3.4, "Wave Quantities and Ratios"](#), on page 54.

**Access:** TRACE > MEAS key or Alt + Shift + A



left = R&S ZNC or bidirectional R&S ZND

right = unidirectional R&S ZND

### a<i> Source Port <i>, b<j> Source Port <i> (softkeys)

Selects one of the standard 2-port wave quantities  $a_i$ ,  $b_j$  for different source ports.

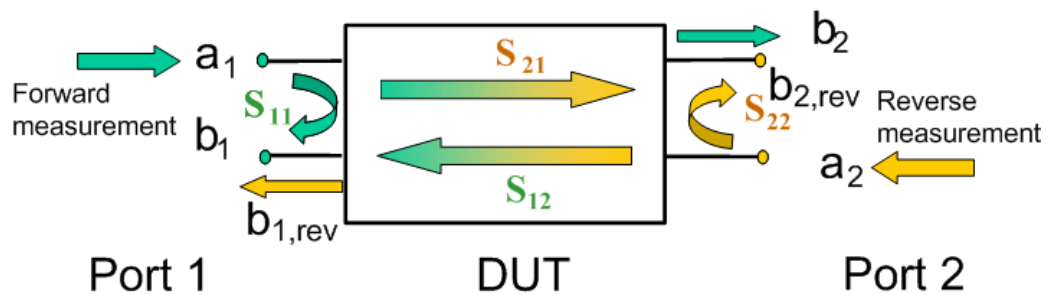

The predefined wave quantities are obtained with different source ports. "a1 Source Port 1, b1 Source Port 1" and "b1 Source Port 2" are measured at Port 1 of the analyzer. "a2 Source Port 2, b2 Source Port 1" and "b2 Source Port 2" are measured at Port 2 of the analyzer.

- "a1 Source Port 1" is the wave transmitted at test port 1. In a standard S-parameter measurement, this wave is fed to the input port (port 1) of the DUT (forward measurement).
- "b1 Source Port 1" is the wave received at test port 1. In a standard S-parameter measurement, this is the reflected wave at port 1 of the DUT (forward measurement).
- "b2 Source Port 1" is the wave received at test port 2. In a standard S-parameter measurement, this wave is transmitted at port 2 of the DUT (forward measurement).
- "a2 Source Port 2" is the wave transmitted at test port 2. In a standard S-parameter measurement, this wave is fed to the output port (port 2) of the DUT (reverse measurement).
- "b1 Source Port 2" is the wave received at test port 1. In a standard S-parameter measurement, this wave is transmitted at port 2 of the DUT (reverse measurement).
- "b2 Source Port 2" is the wave received at test port 2. In a standard S-parameter measurement, this wave is fed to the output port (port 2) of the DUT (reverse measurement).

**Tip:** In the trace list the source port is indicated in brackets. "a1(P1)" denotes the wave  $a_1$  with source port 1.

The analyzer can also measure arbitrary wave quantities for other source ports; see [More Wave Quantities](#).

**Note:** For a unidirectional R&S ZND (see [Chapter 3.1.4.2, "R&S ZND: Unidirectional vs. Bidirectional Operation"](#), on page 16) wave quantities for source port 2 are not available.

Remote command:

```
CALCulate<Ch>:PARAMeter:MEASure "<Trace_Name>", "A1" | ...
```

Create new trace and select trace name and measurement parameter:

```
CALCulate<Ch>:PARAMeter:SDEFine "<Trace_Name>", "A1" | ...
```

### More Wave Quantities

Opens a dialog to select arbitrary wave quantities, e.g. for different source ports or higher port numbers.

#### 4.2.1.7 More Wave Quantities (Dialog)

The "More Wave Quantities" dialog provides arbitrary wave quantities with arbitrary source ports as measured quantities. All wave quantities can be calculated with different detector settings.



#### Background information

Refer to the following sections:

- [Chapter 3.3.4.1, "Wave Quantities"](#), on page 54
- [Chapter 3.3.4.2, "Ratios"](#), on page 55

**Access:** TRACE > MEAS > Wave Quantities > More Wave Quantities...

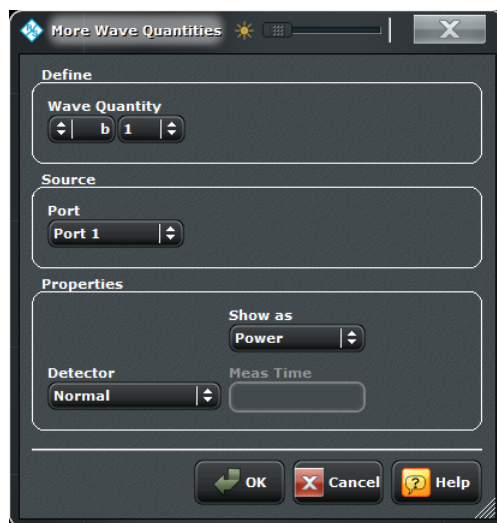

For a unidirectional R&S ZND (see [Chapter 3.1.4.2, "R&S ZND: Unidirectional vs. Bidirectional Operation"](#), on page 16) only port 1 may serve as source and hence the corresponding control is disabled.

The notation for wave quantities follows the usual scheme of the vector network analyzer:

- The a-waves are the outgoing/transmitted waves at the analyzer's test ports.
- The b-waves are the incoming/measured waves.
- The source port for the stimulus signal must be specified in addition.
- The port number range covers all test ports of the analyzer.

#### Wave Quantity

Selects the type (left pull-down list) and the port number assignment (right pull-down list) of the wave quantity.

Remote command:

```
CALCulate<Ch>:PARAmeter:MEASure "<Trace_Name>", "A1" ...
```

Create new trace and select trace name and measurement parameter:

```
CALCulate<Ch>:PARAmeter:SDEFine "<Trace_Name>", "A1" ...
```

### Port

The source port for the stimulus signal: "Port 1" or "Port 2" for a R&S ZNC or a bidirectional R&S ZND. For a unidirectional R&S ZND (see [Chapter 3.1.4.2, "R&S ZND: Unidirectional vs. Bidirectional Operation"](#), on page 16) only port 1 may serve as source and hence this control is disabled.

The analyzer places no restriction on the combination of source ports and port numbers of the measured wave quantity, so it is even possible to measure  $a_2$  while the source port is Port 1 (e.g. in order to estimate the directivity of the coupler in the internal test set).

Remote command:

```
CALCulate<Ch>:PARAmeter:MEASure "<Trace_Name>", "A1" ...
```

Create new trace and select trace name and measurement parameter:

```
CALCulate<Ch>:PARAmeter:SDEFine "<Trace_Name>", "A1" ...
```

(the parameter name <Ratio> can also contain the source port)

### Show as

Selects the physical unit of the displayed trace. It is possible to display the measured "Voltage" V or convert the wave quantity into an effective power according to  $P = V^2 / \text{Re}(Z_0)$ .  $Z_0$  denotes the reference impedance of the source port (for wave quantities  $a_n$ ) or of the receive port (for wave quantities  $b_n$ ).

The reference impedances are defined in the "Balanced Ports" dialog; see [Chapter 4.2.1.3, "Balanced Ports Dialog"](#), on page 132.

Remote command:

```
CALCulate<Chn>:FORMat:WQUType
```

### Detector

Selects the algorithm that is used to calculate the displayed measurement points from the raw data.

For details refer to: [Chapter 3.3.4.3, "Detector Settings"](#), on page 56.

Remote command:

```
CALCulate<Ch>:PARAmeter:MEASure "<Trace_Name>", "<Ratio>"
```

```
CALCulate<Ch>:PARAmeter:SDEFine "<Trace_Name>", "<Ratio>"
```

(the parameter name <Ratio> can also contain the detector)

```
[SENSe<Ch>:]SWEep:DETEctor:TIME
```

#### 4.2.1.8 Meas > Z←Sij

Selects converted impedances as measured quantities. The impedances are calculated from the measured S-parameters.



### Background information

Refer to the following sections:

- [Chapter 3.3.2, "Impedance Parameters"](#), on page 49
- [Chapter 3.3.2.1, "Converted Impedances"](#), on page 49

**Access:** TRACE > MEAS key or Alt + Shift + A

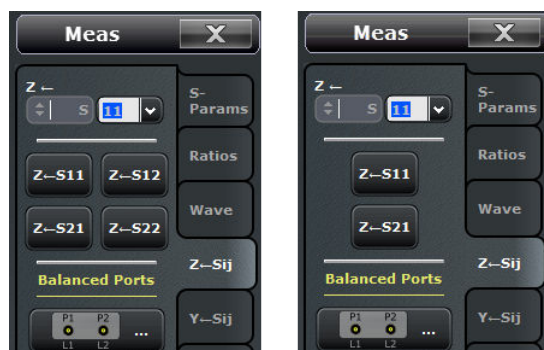

left = R&S ZNC or bidirectional R&S ZND  
right = unidirectional R&S ZND

### Z←S<out><in> selector

Selects a converted impedance parameter as a measured quantity for the active trace. For an n-port vector network analyzer, the pull-down list provides the full set of  $n^2$  impedance parameters.

Converted impedance parameters are expressed as  $Z \leftarrow_{\langle \text{out} \rangle \langle \text{in} \rangle}$ , where  $\langle \text{out} \rangle$  and  $\langle \text{in} \rangle$  denote the output and input port numbers of the DUT.

**Note:** For a unidirectional R&S ZND (see [Chapter 3.1.4.2, "R&S ZND: Unidirectional vs. Bidirectional Operation"](#), on page 16) the reverse direction cannot be measured. Hence  $Z \leftarrow S_{12}$ ,  $Z \leftarrow S_{22}$  are not available.

Remote command:

```
CALCulate<Ch>:PARAmeter:MEASure "<Trace_Name>", "Z-S11" |
"Z-S12" ...
```

Create new trace and select trace name and measurement parameter:

```
CALCulate<Ch>:PARAmeter:SDEFine "<Trace_Name>", "Z-S11" |
"Z-S22" | ...
```

### Z←S<out><in> softkeys

Selects the 2-port converted impedance parameters. The parameters describe the impedances of a 2-port DUT, obtained in forward and reverse transmission and reflection measurements:

- $Z_{11}$  is the input impedance at port 1 of a 2-port DUT that is terminated at port 2 with the reference impedance  $Z_0$  (matched-circuit impedance measured in a forward reflection measurement).
- $Z_{22}$  is the input impedance at port 2 of a 2-port DUT that is terminated at port 1 with the reference impedance  $Z_0$  (matched-circuit impedance measured in a reverse reflection measurement).

- $Z_{12}$  and  $Z_{21}$  denote the forward and reverse converted transfer impedances, respectively.

Use the Smith chart to obtain an alternative, graphical representation of the converted impedances in a reflection measurement.

**Note:** For a unidirectional R&S ZND (see [Chapter 3.1.4.2, "R&S ZND: Unidirectional vs. Bidirectional Operation"](#), on page 16) the reverse direction cannot be measured. Hence  $Z_{12}$ ,  $Z_{22}$  are not available.

**Tip:** For a R&S ZNC or bidirectional R&S ZND you can use the "Y- Z-Params" tab to measure Z-parameters including the transfer parameters.

Remote command:

```
CALCulate<Ch>:PARAmeter:MEASure "<Trace_Name>", "Z-S11" |
"Z-S12" | "Z-S21" | "Z-S22"
```

Create new trace and select trace name and measurement parameter:

```
CALCulate<Ch>:PARAmeter:SDEFine "<Trace_Name>", "Z-S11" |
"Z-S12" | "Z-S21" | "Z-S22"
```

### Balanced Ports...

Opens a dialog to configure the logical ports of the analyzer.

See [Chapter 4.2.1.3, "Balanced Ports Dialog"](#), on page 132.

#### 4.2.1.9 Meas > Y←Sij

Selects converted admittances as measured quantities. The admittances are calculated from the measured S-parameters.



### Background information

Refer to the following sections:

- [Chapter 3.3.3, "Admittance Parameters"](#), on page 52
- [Chapter 3.3.3.1, "Converted Admittances"](#), on page 52

**Access:** TRACE > MEAS key or Alt + Shift + A



left = R&S ZNC or bidirectional R&S ZND  
right = unidirectional R&S ZND



**Y←S<out><in> selector**

Selects a converted admittance parameter as a measured quantity for the active trace. For an n-port vector network analyzer, the pull-down list provides the full set of  $n^2$  admittance parameters.

Converted admittance parameters are expressed as  $Y_{\leftarrow S_{\leftarrow \text{out}} \leftarrow \text{in}} \rightleftarrows$ , where <out> and <in> denote the output and input port numbers of the DUT.

**Note:** For a unidirectional R&S ZND (see [Chapter 3.1.4.2, "R&S ZND: Unidirectional vs. Bidirectional Operation"](#), on page 16) the reverse direction cannot be measured. Hence  $Y_{\leftarrow S_{12}}$ ,  $Y_{\leftarrow S_{22}}$  are not available.

Remote command:

```
CALCulate<Ch>:PARAmeter:MEASure "<Trace_Name>", "Y-S11" |
"Y-S12" ...
```

Create new trace and select trace name and measurement parameter:

```
CALCulate<Ch>:PARAmeter:SDEFine "<Trace_Name>", "Y-S11" |
"Y-S22" | ...
```

**Y←S<out><in> softkeys**

Selects the 2-port converted admittance parameters. The parameters describe the admittances of a 2-port DUT, obtained in forward and reverse transmission and reflection measurements:

- $Y_{11}$  is the input admittance at port 1 of a 2-port DUT that is terminated at port 2 with the reference impedance  $Z_0$  (matched-circuit admittance measured in a forward reflection measurement).
- $Y_{22}$  is the input admittance at port 2 of a 2-port DUT that is terminated at port 1 with the reference impedance  $Z_0$  (matched-circuit admittance measured in a reverse reflection measurement).
- $Y_{12}$  and  $Y_{21}$  denote the forward and reverse converted transfer admittances, respectively.

Use the Smith chart to obtain an alternative, graphical representation of the converted impedances in a reflection measurement.

**Note:** For a unidirectional R&S ZND (see [Chapter 3.1.4.2, "R&S ZND: Unidirectional vs. Bidirectional Operation"](#), on page 16) the reverse direction cannot be measured. Hence  $Y_{12}$ ,  $Y_{22}$  are not available.

**Tip:** For a R&S ZNC or bidirectional R&S ZND you can use the "Y- Z-Params" tab to measure Y-parameters including the transfer parameters.

Remote command:

```
CALCulate<Ch>:PARAmeter:MEASure "<Trace_Name>", "Y-S11" |
"Y-S12" | "Y-S21" | "Y-S22"
```

Create new trace and select trace name and measurement parameter:

```
CALCulate<Ch>:PARAmeter:SDEFine "<Trace_Name>", "Y-S11" |
"Y-S12" | "Y-S21" | "Y-S22"
```

**Balanced Ports...**

Opens a dialog to configure the logical ports of the analyzer.

See [Chapter 4.2.1.3, "Balanced Ports Dialog"](#), on page 132.

#### 4.2.1.10 Meas > Y-Z-Params

Selects Y- and Z-parameters as measured quantities. Both the Y-parameters and the Z-parameters can be used as an alternative to S-parameters in order to completely characterize a linear n-port network.



#### Background information

Refer to the following sections:

- [Chapter 3.3.2, "Impedance Parameters"](#), on page 49
- [Chapter 3.3.3, "Admittance Parameters"](#), on page 52
- [Chapter 3.3.2.2, "Z-Parameters"](#), on page 51
- [Chapter 3.3.3.2, "Y-Parameters"](#), on page 53

**Access:** TRACE > MEAS key or Alt + Shift + A

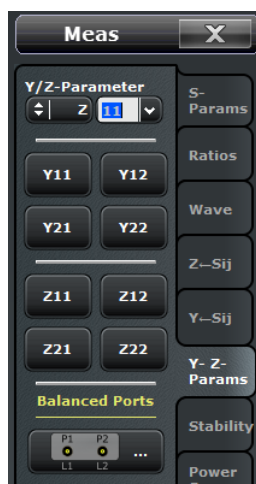

For a unidirectional R&S ZND (see [Chapter 3.1.4.2, "R&S ZND: Unidirectional vs. Bidirectional Operation"](#), on page 16) this tab is not available.

#### Y/Z-Parameter

Selects an Y- or Z-parameter as a measured quantity for the active trace. For an n-port vector network analyzer, the pull-down list provides the full set of  $n^2$  Y- and Z-parameters.

Y- and Z-parameters are expressed as  $Y/Z_{\text{out} \leftarrow \text{in}}$ , where <out> and <in> denote the output and input port numbers of the DUT.

Remote command:

```
CALCulate<Ch>:PARAmeter:MEASure "<Trace_Name>", "Y11" |
"Z11" ...
```

Create new trace and select trace name and measurement parameter:

```
CALCulate<Ch>:PARAmeter:SDEFine "<Trace_Name>", "Y11" |
"Z11" ...
```

**Y11 / Y12 / Y21 / Y22**

Selects the 2-port Y- parameters as a measured quantity for the active trace. The Y- parameters describe the admittances of a DUT with output ports terminated in a short circuit ( $V = 0$ ).

The four 2-port Y-parameters can be interpreted as follows:

- $Y_{11}$  is the input admittance, defined as the ratio of the current  $I_1$  to the voltage  $V_1$ , measured at port 1 (forward measurement with output terminated in a short circuit,  $V_2 = 0$ ).
- $Y_{21}$  is the forward transfer admittance, defined as the ratio of the current  $I_2$  to the voltage  $V_1$  (forward measurement with output terminated in a short circuit,  $V_2 = 0$ ).
- $Y_{12}$  is the reverse transfer admittance, defined as the ratio of the current  $I_1$  to the voltage  $V_2$  (reverse measurement with input terminated in a short circuit,  $V_1 = 0$ ).
- $Y_{22}$  is the output admittance, defined as the ratio of the current  $I_2$  to the voltage  $V_2$ , measured at port 2 (reverse measurement with input terminated in a short circuit,  $V_1 = 0$ ).

Remote command:

```
CALCulate<Ch>:PARAmeter:MEASure "<Trace_Name>", "Y11" | "Y12" | "Y21" | "Y22"
```

Create new trace and select trace name and measurement parameter:

```
CALCulate<Ch>:PARAmeter:SDEFine "<Trace_Name>", "Y11" | "Y12" | "Y21" | "Y22"
```

**Z11 / Z12 / Z21 / Z22**

Selects the 2-port Z-parameters as a measured quantity for the active trace. The Z- parameters describe the impedances of a DUT with open output ports ( $I = 0$ ).

The four 2-port Z-parameters can be interpreted as follows:

- $Z_{11}$  is the input impedance, defined as the ratio of the voltage  $V_1$  to the current  $I_1$ , measured at port 1 (forward measurement with open output,  $I_2 = 0$ ).
- $Z_{21}$  is the forward transfer impedance, defined as the ratio of the voltage  $V_2$  to the current  $I_1$  (forward measurement with open output,  $I_2 = 0$ ).
- $Z_{12}$  is the reverse transfer impedance, defined as the ratio of the voltage  $V_1$  to the current  $I_2$  (reverse measurement with open input,  $I_1 = 0$ ).
- $Z_{22}$  is the output impedance, defined as the ratio of the voltage  $V_2$  to the current  $I_2$ , measured at port 2 (reverse measurement with open input,  $I_1 = 0$ ).

Remote command:

```
CALCulate<Ch>:PARAmeter:MEASure "<Trace_Name>", "Z11" | "Z12" | "Z21" | "Z22"
```

Create new trace and select trace name and measurement parameter:

```
CALCulate<Ch>:PARAmeter:SDEFine "<Trace_Name>", "Z11" | "Z12" | "Z21" | "Z22"
```

**Balanced Ports...**

Opens a dialog to define a balanced port configuration.

See [Balanced Ports Dialog](#).

#### 4.2.1.11 Meas > Stability

Selects one of the three two port stability factors  $K$ ,  $\mu_1$  or  $\mu_2$  as measured quantities. A typical application of stability factors is to assess the stability of an amplifier. Stability factors cannot be calculated in balanced port configurations.



#### Background information

Refer to [Chapter 3.3.7, "Stability Factors"](#), on page 61.

**Access:** TRACE > MEAS key or Alt + Shift + A

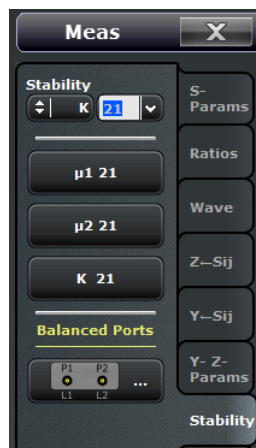

For a unidirectional R&S ZND (see [Chapter 3.1.4.2, "R&S ZND: Unidirectional vs. Bidirectional Operation"](#), on page 16) this tab is not available.

#### Stability

Selects a stability parameter as a measured quantity for the active trace. The stability factor calculation is based on 2-port reflection **and** transmission S-parameters so that the input and output port numbers must be different. The pull-down list contains all possible physical (single-ended) port combinations. For an analyzer with  $n$  ports, provides  $n * (n - 1)$  stability parameters.

Stability parameters are expressed as " $K_{\langle out \rangle \langle in \rangle}$ ", " $\mu 1_{\langle out \rangle \langle in \rangle}$ ", and " $\mu 2_{\langle out \rangle \langle in \rangle}$ ", where  $\langle out \rangle$  and  $\langle in \rangle$  denote the logical output and input port numbers of the DUT.

Remote command:

```
CALCulate<Ch>:PARAmeter:MEASure "<Trace_Name>", "KFAC21" |
"MU121" | "MU221" | ...
```

Create new trace and select trace name and measurement parameter:

```
CALCulate<Ch>:PARAmeter:SDEFine "<Trace_Name>", "KFAC21" |
"MU121" | "MU221" | ...
```

#### $\mu 1$ 21 / $\mu 2$ 21 / K 21

Selects one of the standard 2-port stability factors as a measured quantity for the active trace. The buttons are available if none of the logical ports 1 and 2 is defined as a balanced port.

Remote command:

```
CALCulate<Ch>:PARAmeter:MEASure "<Trace_Name>", "MUF121" |
"MUF221" | "KFAC21"
```

Create new trace and select trace name and measurement parameter:

```
CALCulate<Ch>:PARAmeter:SDEFine "<Trace_Name>", "MUF121" |
"MUF221" | "KFAC21"
```

### Balanced Ports...

Opens a dialog to define a balanced port configuration.

See [Chapter 4.2.1.3, "Balanced Ports Dialog"](#), on page 132.

#### 4.2.1.12 Meas > Power Sensor

Opens a configuration dialog for the measurement of wave quantities using an external power meter.

**Access:** TRACE > MEAS key or Alt + Shift + A



left = R&S ZNC or bidirectional R&S ZND  
right = unidirectional R&S ZND

The standard test setup for a "Power Sensor" measurement involves one analyzer source port and a power sensor. The power sensor is connected e.g. to the analyzer's USB port and provides the (scalar) wave quantity results. See examples in [Chapter 3.7.11, "External Power Meters"](#), on page 117.

### Power Meter

Shows a list of all power meters that have been properly configured. See ["Configured Devices"](#) on page 352.

The bordered label below displays the type and serial number of the selected power meter.

Remote command:

```
CALCulate<Ch>:PARAmeter:MEASure 'TraceName', 'PmtrD1 | ...
CALCulate<Ch>:PARAmeter:SDEFine 'TraceName', 'PmtrD1 | ...
```

**Auto Zero**

Initiates an automatic zeroing procedure of the power meter which must be disconnected from the RF power; see "Zeroing" on page 118. A message indicates that zeroing is finished.

Remote command:

```
SYSTem:COMMUnicate:RDEvice:PMETer<Pmtr>:AZERo
```

**Source Port**

Selects one of the available test ports of the analyzer as a source of the stimulus signal.

**Note:** For a unidirectional R&S ZND (see [Chapter 3.1.4.2, "R&S ZND: Unidirectional vs. Bidirectional Operation"](#), on page 16) only port 1 may serve as source and hence this control is disabled.

Remote command:

```
CALCulate<Ch>:PARAmeter:MEASure 'TraceName', 'PmtrD1 | ...  
CALCulate<Ch>:PARAmeter:SDEFine 'TraceName', 'PmtrD1 | ...
```

**Show as**

Selects the physical unit of the displayed trace. It is possible to display the measured "Voltage" V or convert the wave quantity into an effective power according to  $P = V^2 / \text{Re}(Z_0)$ .  $Z_0$  denotes the reference impedance of the source port. The reference impedances are defined in the "Balanced Ports" dialog ("TRACE > MEAS > S-Params > Balanced Ports...").

Remote command:

```
CALCulate<Chn>:FORMat:WQUType
```

## 4.2.2 Format Settings

The "Format" menu defines how the measured data is presented in the diagram area.

**Measured quantities and display formats**

The analyzer allows arbitrary combinations of display formats and measured quantities ("Trace > Measure"). Nevertheless, in order to extract useful information from the data, it is important to select a display format which is appropriate to the analysis of a particular measured quantity.

An extended range of formats is available for markers. To convert any point on a trace, create a marker and select the appropriate marker format ("TRACE > MARKER > Marker Format"). Marker and trace formats can be applied independently.

---

**Background information**

Refer to the following sections:

- [Chapter 3.2.4, "Display Formats and Diagram Types"](#), on page 39
  - [Chapter 3.2.4.6, "Measured Quantities and Display Formats"](#), on page 47
-

**Access:** TRACE > FORMAT key or Alt + Shift + B



### dB Mag

Selects a Cartesian diagram with a logarithmic scale of the vertical axis to display the magnitude of the complex measured quantity.

**Properties:** The stimulus variable appears on the horizontal axis, scaled linearly. The magnitude of the complex quantity  $C$ , i.e.  $|C| = \sqrt{\text{Re}(C)^2 + \text{Im}(C)^2}$ , appears on the vertical axis, scaled in dB. The decibel conversion is calculated according to  $\text{dB Mag}(C) = 20 * \log(|C|)$  dB.

**Application:** dB Mag is the default format for the complex, dimensionless S-parameters. The dB-scale is the natural scale for measurements related to power ratios (insertion loss, gain etc.).

**Tip (alternative formats):** The magnitude of each complex quantity can be displayed on a linear scale. It is possible to view the real and imaginary parts instead of the magnitude and phase. Both the magnitude and phase are displayed in the polar diagram.

Remote command:

`CALCulate<Chn>:FORMat MLOGarithmic`

### Phase

Selects a Cartesian diagram with a linear vertical axis to display the phase of a complex measured quantity in the range between  $-180$  degrees and  $+180$  degrees.

**Properties:** The stimulus variable appears on the horizontal axis, scaled linearly. The phase of the complex quantity  $C$ , i.e.  $\varphi(C) = \arctan(\text{Im}(C) / \text{Re}(C))$ , appears on the vertical axis.  $\varphi(C)$  is measured relative to the phase at the start of the sweep (reference phase =  $0^\circ$ ). If  $\varphi(C)$  exceeds  $+180^\circ$  the curve jumps by  $-360^\circ$ ; if it falls below  $-180^\circ$ , the trace jumps by  $+360^\circ$ . The result is a trace with a typical sawtooth shape. The alternative "Phase Unwrapped" format avoids this behavior.

**Application:** Phase measurements, e.g. phase distortion, deviation from linearity.

**Tip (alternative formats):** The magnitude of each complex quantity can be displayed on a linear scale or on a logarithmic scale. It is possible to view the real and imaginary parts instead of the magnitude and phase. Both the magnitude and phase are displayed in the polar diagram. As an alternative to direct phase measurements, the analyzer provides the derivative of the phase response for a frequency sweep (Delay).

Remote command:

```
CALCulate<Chn>:FORMat PHASe
```

### Smith

Selects a Smith chart to display a complex quantity, primarily a reflection S-parameter.

**Properties:** The Smith chart is a circular diagram obtained by mapping the positive complex semi-plane into a unit circle. Points with the same resistance are located on circles, points with the same reactance produce arcs. If the measured quantity is a complex reflection coefficient  $S_{ij}$ , then the unit Smith chart represents the normalized impedance. In contrast to the polar diagram, the scaling of the diagram is not linear.

**Application:** Reflection measurements; see example in [Chapter 3.2.4.4, "Smith Chart"](#), on page 42.

**Tip:** The axis for the sweep variable is lost in Smith charts but the marker functions easily provide the stimulus value of any measurement point. dB values for the magnitude and other conversions can be obtained by means of the "Marker Format" functions.

Remote command:

```
CALCulate<Chn>:FORMat SMITh
```

### Polar

Selects a polar diagram to display a complex quantity, primarily an S-parameter or ratio.

**Properties:** The polar diagram shows the measured data (response values) in the complex plane with a horizontal real axis and a vertical imaginary axis. The magnitude of a complex value is determined by its distance from the center, its phase is given by the angle from the positive horizontal axis. In contrast to the Smith chart, the scaling of the axes is linear.

**Application:** Reflection or transmission measurements, see example in [Chapter 3.2.4.3, "Polar Diagrams"](#), on page 41.

**Tip:** The axis for the sweep variable is lost in polar diagrams but the marker functions easily provide the stimulus value of any measurement point. dB values for the magnitude and other conversions can be obtained by means of the "Marker Format" functions.

Remote command:

```
CALCulate<Chn>:FORMat POLar
```

### Delay

Calculates the (group) delay from the measured quantity (primarily: from a transmission S-parameter) and displays it in a Cartesian diagram.



**Properties:** The group delay  $\tau_g$  represents the propagation time of wave through a device.  $\tau_g$  is a real quantity and is calculated as the negative of the derivative of its phase response. A non-dispersive DUT shows a linear phase response, which produces a constant delay (a constant ratio of phase difference to frequency difference).

For more information refer to [Chapter 3.3.8, "Delay, Aperture, Electrical Length"](#), on page 62.

**Application:** Transmission measurements, especially with the purpose of investigating deviations from linear phase response and phase distortions. To obtain the delay a frequency sweep must be active.

**Tip:** The cables between the analyzer test ports and the DUT introduce an unwanted delay, which often can be assumed to be constant. Use the "Zero Delay at Marker" function, define a numeric length "Offset" or use the "Auto Length" function to mathematically compensate for this effect in the measurement results. To compensate for a frequency-dependent delay in the test setup, a system error correction is required.

**Note:** The delay for reflection factors corresponds to the transmission time in forward and reverse direction; see "Length and delay measurement" in [Chapter 3.6.1.3, "Auto Length"](#), on page 104.

Remote command:

`CALCulate<Chn>:FORMat GDElay`

### Aperture

Sets a delay aperture for the delay calculation. The aperture  $\Delta f$  is entered as an integer number of steps. An aperture step corresponds to the distance between two sweep points.

**Properties:** The delay at each sweep point is computed as:

$$\tau_{g,meas} = -\frac{\Delta\phi_{deg}}{360^\circ \cdot \Delta f}$$

where the aperture  $\Delta f$  is a finite frequency interval around the sweep point  $f_0$  and the analyzer measures the corresponding phase change  $\Delta\Phi$ .

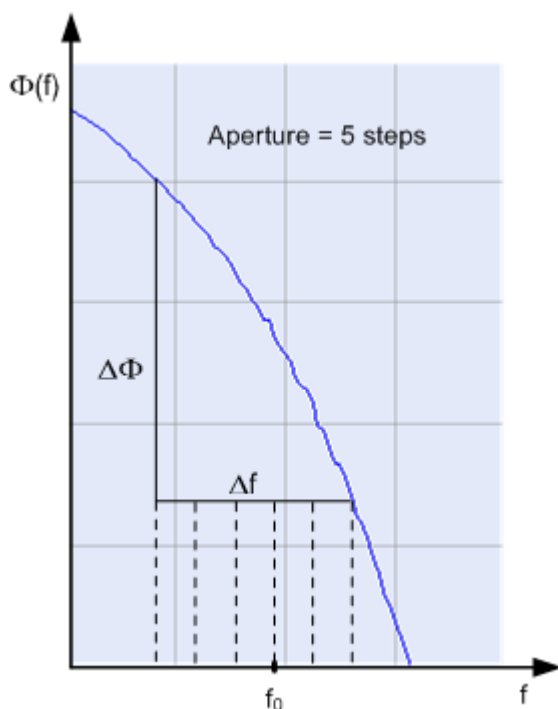

#### Calculation of $\Delta f$ and $\Delta\Phi$

With a given number of aperture steps  $n$  the delay at sweep point no.  $m$  is calculated as follows:

- If  $n$  is even ( $n = 2k$ ), then  $\Delta f(m) = f(m+k) - f(m-k)$  and  $\Delta\Phi(m) = \Delta\Phi(m+k) - \Delta\Phi(m-k)$ .
- If  $n$  is odd ( $n = 2k+1$ ), then  $\Delta f(m) = f(m+k) - f(m-k-1)$  and  $\Delta\Phi(m) = \Delta\Phi(m+k) - \Delta\Phi(m-k-1)$ .

The calculated phase difference (and thus the group delay) is always assigned to the frequency point no.  $m$ . For linear sweeps and odd numbers of aperture steps, the center of the aperture range is  $[f(m+k) + f(m-k-1)] / 2 = f(m-1/2)$ , i.e. half a frequency step size below the sweep point  $f(m)$ . This is why toggling from even to odd numbers of aperture steps and back can virtually shift the group delay curve towards higher/lower frequencies. It is recommended to use even numbers of aperture steps, especially for large frequency step sizes.

The delay calculation is based on the already measured sweep points and does not slow down the measurement.

$\Delta f$  is constant over the entire sweep range, if the sweep type is a Lin. Frequency sweep. For Log. Frequency and Segmented Frequency sweeps, it varies with the sweep point number  $m$ .

**Application:** The aperture must be adjusted to the conditions of the measurement. A small aperture increases the noise in the group delay; a large aperture tends to minimize the effects of noise and phase uncertainty, but at the expense of frequency resolution. Phase distortions (i.e. deviations from linear phase) which are narrower in frequency than the aperture tend to be smeared over and cannot be measured.

Remote command:

`CALCulate<Chn>:GDAPerture:SCount`

**SWR**

Calculates the Standing Wave Ratio (SWR) from the measured quantity (primarily: from a reflection S-parameter) and displays it in a Cartesian diagram.

**Properties:** The SWR (or Voltage Standing Wave Ratio, VSWR) is a measure of the power reflected at the input of the DUT. It is calculated from the magnitude of the reflection coefficients  $S_{ii}$  (where  $i$  denotes the port number of the DUT) according to:

$$SWR = \frac{1 + |S_{ii}|}{1 - |S_{ii}|}$$

The superposition of the incident and the reflected wave on the transmission line connecting the analyzer and the DUT causes an interference pattern with variable envelope voltage. The SWR is the ratio of the maximum voltage to the minimum envelope voltage along the line.

**Interpretation of the SWR**

The superposition of the incident wave  $I$  and the reflected wave  $R$  on the transmission line connecting the analyzer and the DUT causes an interference pattern with variable envelope voltage. The SWR is the ratio of the maximum voltage to the minimum envelope voltage along the line:

$$SWR = V_{Max}/V_{Min} = (|V_I| + |V_R|) / (|V_I| - |V_R|) = (1 + |S_{ii}|) / (1 - |S_{ii}|)$$

**Application:** Reflection measurements with conversion of the complex S-parameter to a real SWR.

Remote command:

`CALCulate<Chn>:FORMat SWR`

**Unwrapped Phase**

Selects a Cartesian diagram with an arbitrarily scaled linear vertical axis to display the phase of the measured quantity.

**Properties:** The stimulus variable appears on the horizontal axis, scaled linearly. The phase of the complex quantity  $C$ , i.e.  $\varphi(C) = \arctan(\text{Im}(C) / \text{Re}(C))$ , appears on the vertical axis.  $\varphi(C)$  is measured relative to the phase at the start of the sweep (reference phase =  $0^\circ$ ). In contrast to the normal Phase format, the display range is not limited to values between  $-180^\circ$  and  $+180^\circ$ . This avoids artificial jumps of the trace but can entail a relatively wide phase range if the sweep span is large.

**Application:** Phase measurements, e.g. phase distortion, deviation from linearity.

**Tip:** After changing to the "Unwrapped Phase" format, use "TRACE > SCALE – Auto Scale Trace" to re-scale the vertical axis and view the entire trace.

Remote command:

`CALCulate<Chn>:FORMat SWR`

**Lin Mag**

Selects a Cartesian diagram with a linear vertical axis scale to display the magnitude of the measured quantity.

**Properties:** The stimulus variable appears on the horizontal axis, scaled linearly. The magnitude of the complex quantity  $C$ , i.e.  $|C| = \sqrt{\text{Re}(C)^2 + \text{Im}(C)^2}$ , appears on the vertical axis, also scaled linearly.

**Application:** Real measurement data (i.e. the Stability Factors and the DC voltages) are always displayed in a Lin Mag diagram.

**Tip (alternative formats):** The magnitude of each complex quantity can be displayed on a logarithmic scale. It is possible to view the real and imaginary parts instead of the magnitude and phase.

Remote command:

```
CALCulate<Chn>:FORMat MLINear
```

### Inv Smith

Selects an inverted Smith chart to display a complex quantity, primarily a reflection S-parameter.

**Properties:** The Inverted Smith chart is a circular diagram obtained by mapping the positive complex semi-plane into a unit circle. If the measured quantity is a complex reflection coefficient  $S_{ij}$ , then the unit Inverted Smith chart represents the normalized admittance. In contrast to the polar diagram, the scaling of the diagram is not linear.

**Application:** Reflection measurements, see example in [Chapter 3.2.4.5, "Inverted Smith Chart"](#), on page 45.

**Tip:** The axis for the sweep variable is lost in Smith charts but the marker functions easily provide the stimulus value of any measurement point. dB values for the magnitude and other conversions can be obtained by means of the "Marker Format" functions.

Remote command:

```
CALCulate<Chn>:FORMat ISMith
```

### Real

Selects a Cartesian diagram to display the real part of a complex measured quantity.

**Properties:** The stimulus variable appears on the horizontal axis, scaled linearly. The real part  $\text{Re}(C)$  of the complex quantity  $C = \text{Re}(C) + j \text{Im}(C)$ , appears on the vertical axis, also scaled linearly.

**Application:** The real part of an impedance corresponds to its resistive portion.

**Tip (alternative formats):** It is possible to view the magnitude and phase of a complex quantity instead of the real and imaginary part. The magnitude can be displayed on a linear scale or on a logarithmic scale. Both the real and imaginary parts are displayed in the polar diagram.

Remote command:

```
CALCulate<Chn>:FORMat REAL
```

### Imag

Selects a Cartesian diagram to display the imaginary part of a complex measured quantity.

**Properties:** The stimulus variable appears on the horizontal axis, scaled linearly. The imaginary part  $\text{Im}(C)$  of the complex quantity  $C = \text{Re}(C) + j \text{Im}(C)$ , appears on the vertical axis, also scaled linearly.

**Application:** The imaginary part of an impedance corresponds to its reactive portion. Positive (negative) values represent inductive (capacitive) reactance.

**Tip (alternative formats):** It is possible to view the magnitude and phase of a complex quantity instead of the real and imaginary part. The magnitude can be displayed on a linear scale or on a logarithmic scale. Both the real and imaginary parts are displayed in the polar diagram.

Remote command:

```
CALCulate<Chn>:FORMat IMAGinary
```

#### Default Marker Frmt

Defines the default marker format of the active trace. "Default" means formatted according to the selected trace format.

New markers will be formatted with the trace's "Default Marker Frmt"; previously existing markers will be reformatted if (and only if) their [Marker Format](#) is set to "(Trace) Default".

For background information on marker formats see "[Marker Format](#)" on page 31.

Remote command:

```
CALCulate<Chn>:MARKer:DEFault:FORMat
```

### 4.2.3 Scale Settings

The "Scale" settings define how the active trace is displayed in the diagram selected in the "Trace > Format" tab.

#### 4.2.3.1 Scale > Scale Values

Provides the functions for diagram scaling.

The "Scale" settings are closely related to the settings in the "Format" submenu and in the "Display" menu. All of them have an influence on the way the analyzer presents data on the screen.

The "Scale" settings depend on the diagram type (Trace > Format) because not all diagrams can be scaled in the same way:

- In Cartesian diagrams, all scale settings are available.
- In circular diagrams, no "Scale/Div.", no "Ref. Position", and no "Max" and "Min" values can be defined.

The default scale is activated automatically when a display format (diagram type) is selected. Scale settings that are not compatible with the current display format are unavailable (grayed).

#### Relations between the scaling parameters

The scaling parameters "Scale / Div, Ref Value, Ref Position, Max, Min" are coupled together in the following manner:

- $\text{Max} - \text{Min} = \text{Scale} / \text{Div} * \langle \text{Number of graticule divisions} \rangle$
- $\text{Max} = \text{Ref Value}$  when Ref Position is 10
- $\text{Min} = \text{Ref Value}$  when Ref Position is 0



### Alternatives and examples

The marker functions and the icons in the toolbar provide alternatives to manual diagram scaling. Refer to the following sections:

- chapter "Scaling Diagrams" in the Getting Started guide
- [Chapter 4.3.1, "Stimulus > Stimulus"](#), on page 228

**Access:** TRACE > SCALE key or Alt + Shift + C

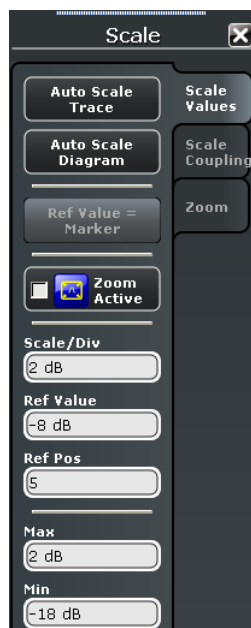

#### Auto Scale Trace

Adjusts the "Scale/Div" and the "Ref Value" in order to display the entire active trace in the diagram area, leaving an appropriate display margin.

- In Cartesian diagrams, the analyzer re-calculates the values of the vertical divisions so that the trace fits onto approx. 80% of the vertical grid. The reference value is chosen to center the trace in the diagram.
- In circular diagrams ("Polar, Smith, Inverted Smith"), the analyzer re-calculates the values of the radial divisions so that the diagram is confined to approx. 80% of the outer circumference. The reference value is set to the value of the outer circumference.

Auto scale does not affect the stimulus values and the horizontal axis.

Remote command:

`DISPlay[:WINDow<Wnd>]:TRACe<WndTr>:Y[:SCALE]:AUTO`

#### Auto Scale Diagram

Adjusts the "Scale/Div" and the "Ref Value" in order to display all traces in the diagram area, leaving an appropriate display margin. This scale settings are analogous to the "Auto Scale Trace" function. The traces in the active diagram area are taken into account irrespective of their channel assignment.

**Ref Value = Marker**

See "Ref Val / Max / Min = Marker" on page 227.

**Zoom Active**

Enables or disables the current scale settings, including all the numeric entries in the input fields below. See also "Using the Graphic Zoom" in the R&S ZNC/ZND Getting Started manual.

**Scale/Div**

Sets the value of the vertical diagram divisions in Cartesian diagrams.

"Scale /Div" corresponds to the increment between two consecutive grid lines. The unit depends on the display format: dB for display format "dB Mag", degrees for "Phase" and "Unwrapped Phase", ns for "Delay", U (units) for all other (dimensionless) formats.

"Scale /Div" is not available (grayed) for circular diagrams ("Polar, Smith, Inverted Smith").

Remote command:

```
DISPlay[:WINDow<Wnd>]:TRACe<WndTr>:Y[:SCALe]:PDIVision
```

**Ref Value**

Sets the reference line of a Cartesian diagram or the outer circumference of a circular diagram.

- In Cartesian diagrams "Ref. Value" defines the value of the reference line, indicated by a ◀ symbol at the right edge of the diagram area. The color of the symbol corresponds to the trace color. As the "Ref. Value" is varied, the position of the reference line (Ref. Position) is left unchanged, so that the current trace is shifted in vertical direction. The unit of the "Ref. Value" depends on the display format: dB for display format "dB Mag", degrees for "Phase" and "Unwrapped Phase", ns for "Delay", U (units) for all other (dimensionless) formats.
- In circular diagrams ("Polar, Smith, Inverted Smith"), Ref. Value defines the value of the outer circumference. Changing Ref. Value enlarges or scales down the diagram, leaving the center unchanged. The unit is U (units) for all circular diagrams.

Remote command:

```
DISPlay[:WINDow<Wnd>]:TRACe<WndTr>:Y[:SCALe]:RLEVel
```

**Ref Position**

Defines the position of the reference line in a Cartesian diagram.

The reference line is indicated by a ◀ symbol at the right edge of the diagram area. The color of the symbol corresponds to the trace color. "Ref. Position" is defined on a linear scale between 0 (bottom line of the diagram) and 10 (top line of the diagram). As the "Ref. Position" is varied, the value of the reference line (Ref. Value) is left unchanged, so the current trace is shifted together with the "Ref. Position".

"Ref. Position" is not available (grayed) for polar diagrams ("Polar, Smith, Inverted Smith").

Remote command:

```
DISPlay[:WINDow<Wnd>]:TRACe<WndTr>:Y[:SCALe]:RPOSition
```

**Max / Min**

Define the upper and lower edge of a Cartesian diagram.

"Max" and "Min" are not available (grayed) for polar diagrams ("Polar, Smith, Inverted Smith").

Remote command:

```
DISPlay[:WINDow<Wnd>]:TRACe<WndTr>:Y[:SCALe]:TOP
```

```
DISPlay[:WINDow<Wnd>]:TRACe<WndTr>:Y[:SCALe]:BOTTom
```

#### 4.2.3.2 Scale > Scale Coupling

Selects common scale settings for all traces. The softkeys are available if the active recall set contains at least two traces, and if the active trace is not a reference trace ("To Trace").



#### Related settings

Refer to [Chapter 4.2.4.2, "Trace Manager \(Dialog\)"](#), on page 164.

**Access:** TRACE > SCALE key or Alt + Shift + C

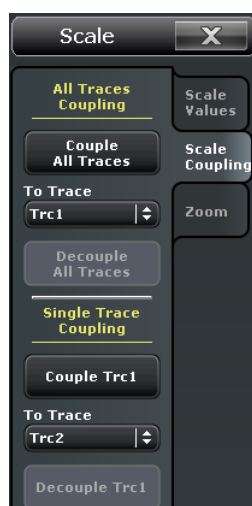

#### Couple ... To Trace

Applies the scale settings of the reference trace ("To Trace") to the active trace or to all traces.

Remote command:

n/a

#### Decouple Active Trace / All Traces

Assigns independent scale settings to the active trace or to all traces.

Remote command:

n/a



### 4.2.3.3 Scale > Zoom

Provides the graphical and numerical zoom functions. A zoom magnifies a rectangular portion of a diagram (zoom window) to fill the entire diagram area ([Zoom Select](#)) or the zoom area ([Overview Select](#)).



#### Alternative settings and examples

The icons in the toolbar provide alternatives to manual zooming. Refer to the following sections:

- chapter "Using the Graphic Zoom" in the Getting Started guide
- [Chapter 4.3.1, "Stimulus > Stimulus"](#), on page 228

**Access:** TRACE > SCALE key or Alt + Shift + C

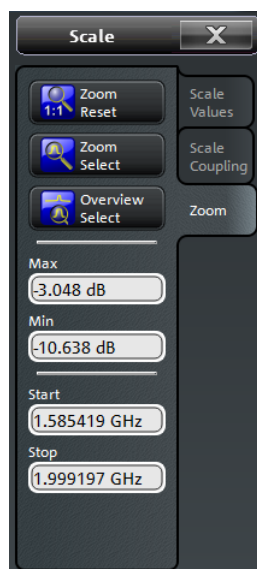

#### Zoom Reset

Disables the zoom function for the active diagram.

Remote command:

```
DISPlay[:WINDow<Wnd>]:TRACe<WndTr>:ZOOM[:STATe]
```

#### Zoom Select

Enables the "zoom in-place" function.

You can define a zoom window for any diagram using the touchscreen or the mouse. Alternatively, you can use the numerical input fields "Max", "Min", "Start", "Stop" to (re)define the zoom window of the active diagram.

Remote command:

```
DISPlay[:WINDow<Wnd>]:TRACe<WndTr>:ZOOM[:STATe]
```

#### Overview Select

Enables the "zoom with overview" function.

The overview appears in the upper part of the active diagram and shows the original diagram and the zoom area. You can move the zoomed part of the trace by moving the zoom area or use the numerical input fields "Max", "Min", "Start", "Stop" to do so.

Remote command:

`DISPlay[:WINDow<Wnd>]:OVERview[:STATe]` on page 522

#### Max / Min / Start / Stop

Defines the coordinates of the zoom window for the active diagram. "Max" and "Min" define the response axis range, "Start" and "Stop" define the stimulus axis range. The input fields are enabled if [Zoom Select](#) or [Overview Select](#) is selected; they are updated after a graphical zoom.

Remote command:

`DISPlay[:WINDow<Wnd>]:TRACe<WndTr>:ZOOM:BOTTom`

`DISPlay[:WINDow<Wnd>]:TRACe<WndTr>:ZOOM:START`

`DISPlay[:WINDow<Wnd>]:TRACe<WndTr>:ZOOM:STOP`

`DISPlay[:WINDow<Wnd>]:TRACe<WndTr>:ZOOM:TOP`

## 4.2.4 Trace Config Settings

The "Trace Config" settings store traces to the memory and perform mathematical operations on traces.

### 4.2.4.1 Trace Config > Traces

Provides functions to handle traces and diagram areas, and assign traces to channels.



#### Related information

Refer to the following sections:

- [Chapter 3.1.3.3, "Active and Inactive Traces and Channels"](#), on page 14
  - See chapter "Operating the Instrument > Handling Diagrams, Traces, and Markers" in the Help system or in the R&S ZNC/ZND Getting Started guide.
- 



In remote control each channel can contain an active trace. The active remote traces and the active manual trace are independent of each other; see [Chapter 5.3.2, "Active Traces in Remote Control"](#), on page 372.

---

**Access:** TRACE > TRACE CONFIG key or Alt + Shift + D

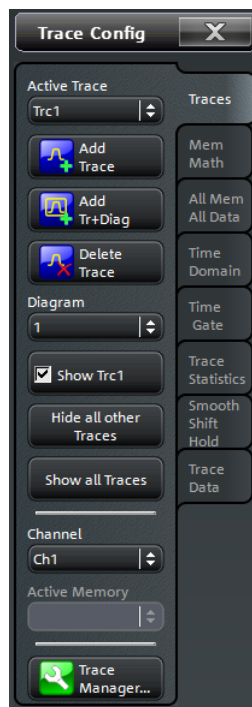

### Active Trace / Diagram / Channel

Selects an arbitrary trace / diagram / channel of the active recall set as the active trace. This function is disabled if only one trace / diagram / channel is defined.

**Tip:** You can simply tap a line in the trace list, the trace itself, a diagram, or a line in the channel list to activate the corresponding elements.

Remote command:

The numeric suffixes <Chn> / <Ch> appended to the first-level mnemonic of a command selects a trace / channel as the active trace / channel. The numeric suffix <Wnd> appended to the DISPLAY:WINDOW<Wnd>: . . . commands selects a diagram area.

### Add Trace

Creates a new trace in the active diagram area and assigns it to the active channel. The new trace is created with the trace and channel settings of the former active trace but displayed with another color. The former and the new active trace are superimposed but can be easily separated, e.g. by changing the "Reference Position".

The new trace is named Trc <n>, where <n> is the largest of all existing trace numbers plus one. The name can be changed in the "Trace Manager" dialog.

**Tip:** To create a new trace in a new channel, use "Channel > Channel Config > Add Ch + Trace".

Remote command:

```
CALCulate<Ch>:PARAMeter:SDEFine
DISPlay[:WINDOW<Wnd>]:TRACe<WndTr>:FEED
```

**Add Trace + Diag**

Creates a new trace in a new diagram area and assigns the trace to the active channel. The new trace is created with the trace and channel settings of the former active trace but displayed with another color.

The new trace is named Trc <n>, where <n> is the largest of all existing trace numbers plus one. The name can be changed in the "Trace Manager".

Remote command:

```
CALCulate<Ch>:PARAmeter:SDEFine
DISPlay[:WINDow<Wnd>] [:STATe] ON
DISPlay[:WINDow<Wnd>]:TRACe<WndTr>:FEED
```

**Delete Trace**

Deletes the active trace and removes it from the diagram area. If the active diagram contains only one trace, the diagram is also deleted.

"Delete Trace" is disabled if the recall set contains only one trace: In manual control, each recall set must contain at least one diagram area with one channel and one trace.

**Tips:** Use the "Trace Manager" to hide traces in the diagrams.

Use the UNDO key to restore a trace that was unintentionally deleted.

Remote command:

```
CALCulate<Ch>:PARAmeter:DELeTe
CALCulate:PARAmeter:DELeTe:ALL
CALCulate<Ch>:PARAmeter:DELeTe:CALL
```

**Diagram**

Allows to move the active trace to another diagram (existing or new)

**Show <Trace Name> / Hide all other Traces / Show all Traces**

Configures the visibility of the traces in the active diagram:

- "Show <Trace Name>" toggles the visibility of the active trace
- "Hide all other Traces" hides all traces except the active one (which may be visible or not)
- "Show all Traces" makes all traces visible

**Note:** These actions can also be performed from the context menu of the trace name segment in the trace list (see [Chapter 3.2.2.4, "Channel List and Channel Settings"](#), on page 35).

**4.2.4.2 Trace Manager (Dialog)**

The "Trace Manager" dialog performs operations on traces.

**Access:** TRACE > TRACE CONFIG > Traces > Trace Manager...

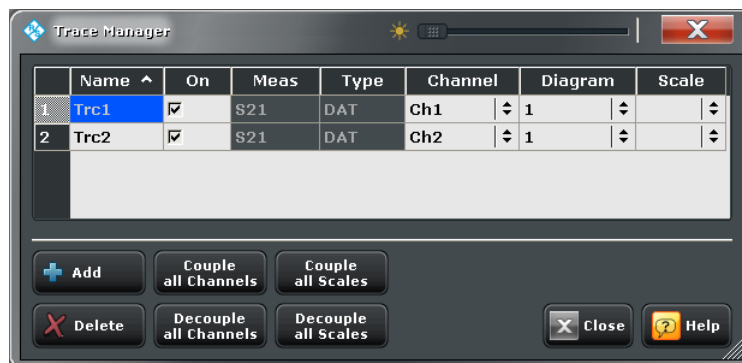

All existing traces of the current recall set are listed in a table with several editable (white) or non-editable (gray) columns.

### Trace Manager Table

The list contains the following columns:

- "Name" indicates the current trace name. The default names for new traces are Trc<n> where <n> is a current number. Current numbers in the trace names are necessary to make automatic assignments, e.g. decouple the channel settings in the "Coupling" dialog. To serve as an unambiguous reference (e.g. in remote control commands), trace names must be unique across all channels and diagram areas in a recall set.
- "On" indicates whether the trace is displayed on the screen ("On") or invisible.
- "Meas" indicates the measured parameter.
- "Type" indicates whether the trace is a data trace ("DAT"), displaying the current measurement data, or a memory trace ("MEM").
- "Channel" indicates the channel of each trace.
- "Area" indicates the diagram area of each trace.
- "Scale" shows which traces use common scaling and format settings.

### Rules for trace names

The analyzer can define mathematical relations between different traces and calculate new mathematical traces (User Def Math). The trace names are used as operands in the mathematical expressions and must be distinguished from the mathematical operators +, -, \*, /, (, ) etc. This places some restrictions on the syntax of trace names:

- The first character of a trace name can be either one of the upper case letters A to Z, one of the lower case letters a to z, an underscore \_ or a square bracket [ or ].
- For all other characters of a trace name, the numbers 0 to 9 can be used in addition.

The analyzer does not accept illegal trace names. If an illegal name is specified, the entry is denied.

Remote command:

```
CALCulate<Ch>:PARAMeter:SDEFine
CONFigure:TRACe<Trc>:REName
CONFigure:TRACe:CATalog?
CONFigure:CHANnel<Ch>:TRACe:CATalog?
CONFigure:CHANnel<Ch>:NAME
CONFigure:CHANnel<Ch>:NAME:ID?
CONFigure:CHANnel<Ch>:TRACe:REName
```

**Add**

Creates a new trace and adds it to the list in the "Trace Manager", assigning it to the channel and diagram area of the active trace.

Remote command:

```
CALCulate<Ch>:PARAmeter:SDEFine
DISPlay[:WINDow<Wnd>]:TRACe<WndTr>:FEED
DISPlay[:WINDow<Wnd>]:TRACe<WndTr>:EFEEd
CONFigure:TRACe:WINDow?
CONFigure:TRACe:WINDow:TRACe?
```

**Delete**

Deletes the selected trace, removing it from the list in the Trace Manager and from the screen. This button is disabled if the recall set contains only one trace: In manual control, each recall set must contain at least one diagram area with one channel and one trace.

Remote command:

```
CALCulate<Ch>:PARAmeter:DELeTe
```

**Couple / Decouple all Channels / Scales**

Selects common channel or scale settings for all traces in the Trace Manager dialog.

- "Couple All ..." assigns all traces to the channel or scale settings of the active trace. All channel or scale settings except the selected ones are lost. The analyzer displays a confirmation dialog box before deleting the unused channels.
- "Decouple All ..." assigns independent channel or scale settings to all traces in the "Trace Manager". If the channel and trace names include numbers, the trace with the lowest number is assigned to the channel with the lowest number and so forth. Measurement or data traces and their associated memory traces are assigned to the same channel.

Remote command:

n/a

**4.2.4.3 New Trace Dialog**

The "New Trace" and "New Ch + Tr" tool bar buttons offer the opportunity to create a new trace either in the active channel or a new one. By dragging and dropping the button onto the diagram area a new diagram can be created on the fly.

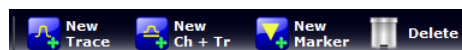

After the button has been dropped, the "New Trace" dialog pops up and allows you to select the S-Parameter for the new trace.

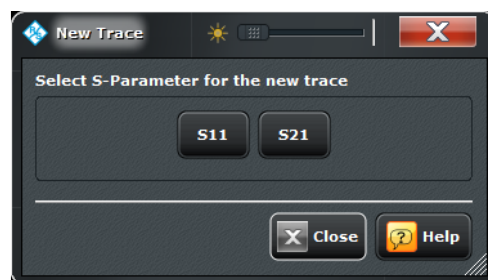
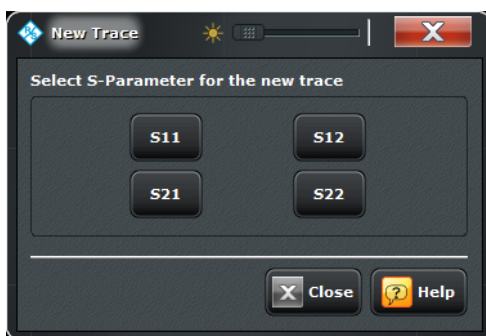

left = R&S ZNC or bidirectional R&S ZND  
 right = unidirectional R&S ZND

#### 4.2.4.4 Trace Config > Mem Math

Stores traces to the memory and performs mathematical operations on traces.



#### Background information

Refer to "Trace Types" on page 27.

**Access:** TRACE > TRACE CONFIG key or Alt + Shift + D



#### Destination

Shows the available memory traces. Some of the other softkeys (e.g. "Data to Mem") act on the selected memory trace.

Remote command:  
 n/a

**Data to <Destination>**

Stores the current state of the active trace as a memory trace. No trace functions are applied to the stored trace. The memory trace is displayed in the active diagram area with another color, and its properties are indicated in the trace list:



Memory traces are named "Mem<n>[<Data\_Trace>]" where <n> counts all data and memory traces in the active recall set in chronological order, and <Data\_Trace> is the name of the associated data trace. Trace names can be changed in the "Trace Manager" dialog.

"Data to <Destination>" overwrites the memory trace selected under "Destination". If "New" is selected, a new memory trace is created.

**Tips:** You can also create memory traces using the "File > More > Import... > Import Data" dialog. Notice that it is not possible to store "Max. Hold" traces to memory ("TRACE CONFIG > Smooth Shift Hold > Hold Mode").

**Coupling of data and memory traces**

When a memory trace is generated from a data trace, it is displayed in the same diagram area and inherits all channel and trace settings from the data trace.

The following display settings of a data trace and the associated memory traces are **fully coupled**. Changing a property of one trace affects the properties of all other traces.

- All "Trace > Format" settings
- All "Trace > Scale" settings

Selection of the measured quantity ("Trace > Measure") is possible for the data trace but disabled for the memory traces.

Channel settings made for a memory trace act on the associated data trace. Some of the channel settings for a data trace (e.g. the "Stimulus" range) also affect the display of the memory traces.

**Note:** If the sweep type of a data trace is changed so that the stimulus ranges of the data traces and the memory traces become incompatible, all coupled memory traces are removed from the diagram area and deleted.

Remote command:

```
CALCulate<Chn>:MATH:MEMorize
TRACe:COPY
```

**Data & Func to <Destination>**

Stores the current state of the active data trace modified by the trace functions as a memory trace.

**Trace functions**

The trace functions comprise the following mathematical operations:

- Any mathematical relation applied to the trace ("Math = Data/Mem, Math = User Def").
- A shift of the trace in horizontal or vertical direction ("TRACE CONFIG > Smooth Shift Hold > Shift Trace").



"Data to <Destination>" stores the raw trace without the trace functions, "Data & Funct to <Destination>" stores the trace after it has been transformed using the trace functions.

Remote command:

```
CALCulate<Chn>:MATH:MEMorize
```

### Show <Destination>

Displays or hides the active memory trace or the memory trace associated with the active data trace.

- If no memory trace is associated with the active data trace, "Show <Destination>" is disabled.
- If several memory traces are associated with the active data trace, "Show <Destination>" affects the last generated or changed memory trace.

Remote command:

```
DISPlay[:WINDow<Wnd>]:TRACe<WndTr>:SHOW
```

### Show <Data>

Displays or hides the active data trace in the diagram area. If "Trace Math" is active, then the active mathematical trace is displayed or hidden.

Remote command:

```
DISPlay[:WINDow<Wnd>]:TRACe<WndTr>:SHOW
```

### Trace Math

Activates the mathematical mode, applying the last active mathematical relation to the active data trace. The data trace is replaced by the mathematical trace. "Math" is displayed in the trace list while the mathematical mode is active.

```
Trc1 S21 dB Mag 10 dB / Ref 0 dB Math
```

"Trace Math" is enabled if the active data trace fulfils the conditions for evaluating the mathematical relation. E.g. if no "User Defined" mathematical relation is defined, a memory trace must be coupled to the active data trace, so that the R&S ZNC/ZND can evaluate one of the relations "Data / Mem" or "Data – Mem".

Remote command:

```
CALCulate<Chn>:MATH:STATe
```

### Data / Mem, Data – Mem

Activates the mathematical mode where the active data trace is divided by (subtracted from) the last generated memory trace. The division (subtraction) is calculated on a point-to-point basis: Each measurement point of the active trace is divided by (subtracted from) the corresponding measurement point of the memory trace. If the memory trace represents the result of a previous sweep with unchanged settings, the divided (subtracted) curve is typically centered around 1 / 0 dB (0); it shows the variation of the results in subsequent sweeps.

The result of the division is a mathematical trace and replaces the active data trace in the diagram area. The mathematical trace is updated as the measurement goes on and the analyzer provides new active trace data.

This function is disabled unless a memory trace is coupled to the active data trace. Trace coupling ensures that the two traces have the same number of points so that the mathematical trace is well-defined.

Remote command:

```
CALCulate<Chn>:MATH:STATE
CALCulate<Chn>:MATH[:EXPRession]:SDEFine
CALCulate<Chn>:MATH:FUNctIon
```

### Define Math

Activates the mathematical mode and displays the mathematical trace defined in the "User Def Math" dialog (see [Chapter 4.2.4.5, "User Def Math \(Dialog\)"](#), on page 170). The mathematical trace replaces the active data trace in the diagram area; it is updated as the measurement goes on and the analyzer provides new active trace data.

Remote command:

```
CALCulate<Chn>:MATH:STATE
CALCulate<Chn>:MATH[:EXPRession]:SDEFine
```

#### 4.2.4.5 User Def Math (Dialog)

The "User Def Math" dialog defines a mathematical relation between traces and calculate a new mathematical trace. Each measurement point of the active trace is replaced by the corresponding point of the mathematical trace.

#### Compatibility between traces in mathematical relations

Mathematical traces are either constant functions or functions of one or more data or memory traces. They are calculated on a point-to-point basis. Each trace point no.  $i$  of the mathematical trace is calculated from a set of constant values  $c_1, \dots, c_n$  plus the trace points  $\text{Trc1}_i, \text{Trcm}_i$  of all traces 1 to  $m$  in the mathematical relation:

$$\text{Math}_i = \text{Fct.}(c_1, \dots, c_n, \text{Trc1}_i, \text{Trcm}_i), i = 1, \text{no. of points}$$

Different traces can be used in the same mathematical relation provided that they contain the same number of points. The analyzer places no further restriction on the compatibility of traces, e.g. the sweep points of the traces do not have to be the same.

The number of points belongs to the channel settings. Coupled data and memory traces are always compatible because they have the same channel settings.



The analyzer processes only numeric values without units in the mathematical formulas. No consistency check for units is performed.

**Access:** TRACE > TRACE CONFIG > Mem Math > Def Math...

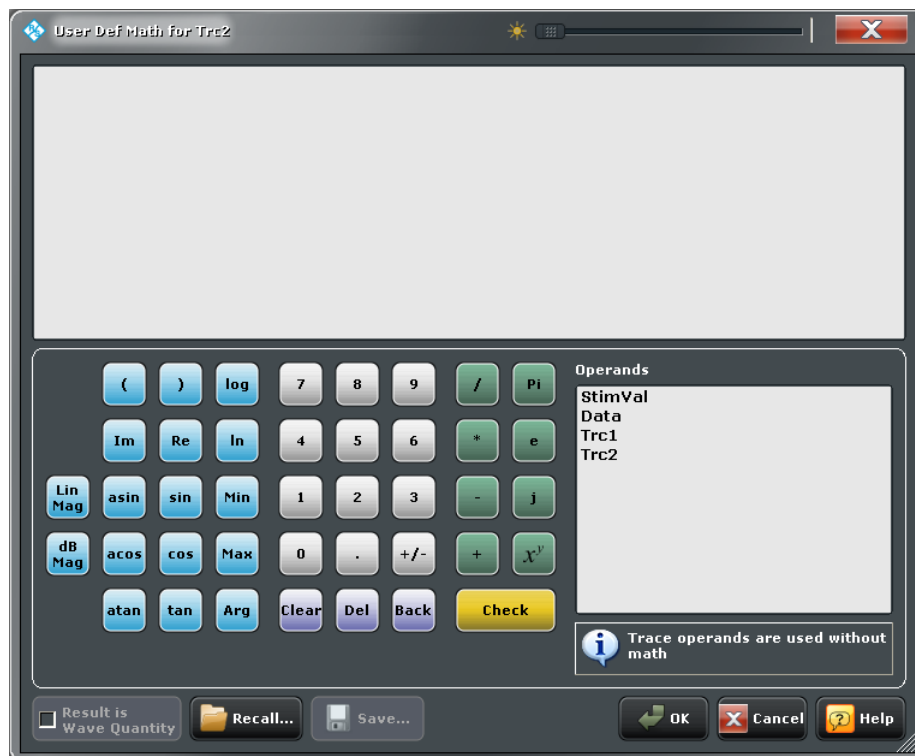

### Mathematical Expression

The mathematical expression appears in the upper part of the dialog. The operands and operators in the expression can be selected from a keyboard and the list of "Operands":

- The keyboard supports the entry of numeric values, constants, and mathematical functions. In addition to the numbers 0 to 9, the decimal point and the constants j (complex unit), pi (approx. 3.14159) and e (approx. 2.71828), it contains the following buttons:
  - +/- changes the sign
  - The effect of the basic arithmetic operators ( $/$ ,  $*$ ,  $-$ ,  $+$ ) and the mathematical functions is described in [Table 4-1](#).  
Products of numbers and constants may be entered in abbreviated form, e.g. 2e for  $2 * e$ .
  - The Clear, Del, Back buttons are used to correct faulty entries.
  - Check performs a consistency check of the displayed mathematical expression and displays a message.
- Operand contains all data traces and memory traces of the active recall set.
  - Data and memory traces are identified by their trace names.
  - "Data" denotes the active data trace.
  - "Mem" is the memory trace associated with the active data trace (or the last created/modified memory trace, if several memory traces are associated with the active data trace).
  - "StimVal" is the array of stimulus values; see footnote for [Table 4-1](#).

The trace operands denote unmodified data and memory traces. Mathematical relations for the traces are not taken into account, even if the mathematical mode

is active ("User Defined: On"). The same applies to smoothing and the "Shift Trace" functions.

**Table 4-1: Effect of the operators on a complex quantity  $z = x + jy$ .**

+ , - , * , /	Basic arithmetic operations
()	Grouping parts of an expression
Lin Mag	$ z  = \sqrt{x^2 + y^2}$
$x^y$	Exponential, e.g. $z^2$
dB Mag	$\text{dB Mag}(z) = 20 * \log z  \text{ dB}$
Arg	Phase $\varphi (z) = \arctan ( \text{Im}(z) / \text{Re}(z) )$
Re, Im	x, y (Real and Imag)
log, ln	Common (base 10) or natural (base e) logarithm
Min, Max	Smaller or larger values of all points of two traces, e.g. $\text{Min}(\text{Trc1}, \text{Trc2})$
StimVal *)	Stimulus value*)
tan, atan, sin, asin, cos, acos	Direct and inverse trigonometric functions.

\*) The function StimVal can be used for all sweep types. Please note that - as with all user math operands - only the numerical value without unit is processed in the user math formula.

- In frequency sweeps StimVal provides the stimulus frequency in Hz.
- In power sweeps, StimVal provides the voltage in V that results from the source power in dBm. To obtain the correct source power in dBm (for "dB Mag" trace format), "Result is Wave Quantity" must be enabled. Note that, due to the conversion into a dBm value, the source power depends on the reference impedance of the port associated with the measured wave quantity, to be set in the "Balanced Ports" dialog.
- In time sweeps, StimVal is the stimulus time in s.
- In CW mode sweeps, StimVal is the number of the point.

Remote command:

`CALCulate<Chn>:MATH:WUNit[:STATe]`

### Result is Wave Quantity

Controls the conversion and formatting of the mathematic expression.

- If "Result is Wave Quantity" is enabled the analyzer assumes that the result of the mathematical expression represents a voltage. Examples for voltage-type expressions are all terms proportional to a wave quantity (e.g.  $1.1 * \text{Data}$ , if a wave quantity is measured) or to a stimulus value of a power sweep. If "Show As: Power" is selected in the "More Wave Quantities" dialog, the result is converted into a linear power before the selected trace format is applied. Otherwise no conversion is performed, and "dB Mag" results are referenced to 1  $\mu\text{V}$ .
- If "Result is Wave Quantity" is disabled the analyzer assumes that the result of the mathematical expression is dimensionless. Examples for dimensionless expressions are all terms proportional to ratios of wave quantities, e.g.  $\text{Data} / \text{Mem2}[\text{Trc1}]$ . The selected trace format is applied without previous conversion.

"Result is Wave Quantity" acts on the result of the mathematical expression only. Wave quantities and power sweep stimulus values always enter into the expression as voltages.

#### Effect of "Result is Wave Quantity"

In the "More Wave Quantities" dialog, the "Show as:" control element specifies whether wave quantities are displayed as voltages or equivalent powers, using the port impedances for a conversion between the two representations. "Result is Wave Quantity" is relevant for mathematical traces displayed in units of "dBm" ("Show as: Power" and trace format "dB Mag"):

If "Result is Wave Quantity" is on (checked), the mathematical trace values  $\langle W \rangle$  are interpreted as voltages and first converted into equivalent powers ( $\langle W \rangle \rightarrow \langle P \rangle = \langle W \rangle^2 / \text{Re}(Z_0)$ ). Results in "dB Mag" format are calculated according to  $\langle P \rangle_{\log} = 10 * \log(\langle P \rangle / 1\text{mW})$ .

- If "Result is Wave Quantity" is off, the mathematical trace values  $\langle W \rangle$  are interpreted as dimensionless quantities. Results in "dB Mag" format are calculated according to  $\langle W \rangle_{\log} = 20 * \log(\langle W \rangle)$ .

#### Example:

A mathematical trace value amounts to 1 (real value); the port impedance is 50 Ω. If "Result is Wave Quantity" is on, the analyzer assumes the trace value to be 1 V, which is converted into a linear power of 20 mW, corresponding to approx. 13 dBm. With "Result is Wave Quantity" off, the trace value 1 is directly converted into a logarithmic power of 0 dBm.

**Tip:** See also example for `CALCulate<Chn>:MATH:WUNit:STATe`.

Remote command:

```
CALCulate<Chn>:MATH:WUNit[:STATe]
```

#### Recall... / Save...

Recalls / saves a mathematical expression from / to a trace math string file. Trace math string files are ASCII files with the default extension `*.mth` and contain the mathematical expression as it is written in the User Def Math... dialog. It is possible to change or create math string files using a text editor.

Remote command:

```
CALCulate<Chn>:MATH:WUNit[:STATe]
```

#### 4.2.4.6 Trace Config > All Mem All Data

Performs actions on all data or memory traces in the active recall set.



#### Background information

Refer to "Trace Types" on page 27.

**Access:** TRACE > TRACE CONFIG key or Alt + Shift + D



### All Data to Mem

Stores all data traces in the current recall set to memory traces, in accordance with the "Copy Dest" setting. No trace functions are applied to the stored traces.

If no memory trace is associated with a data trace, then a new memory trace is created. The new trace is named "Mem<n+1>[<Data\_Trace>]", where n is the largest of all existing memory trace indices. If several memory traces are associated with a data trace, the newest memory trace is replaced.

Remote command:

`TRACe:COPI`

### All Data & Func to Mem

Stores the current state of the active data traces modified by the trace functions to memory traces, in accordance with the "Destination" setting.

### Trace functions

The trace functions comprise the following mathematical operations:

- Any mathematical relation applied to the trace ("Math = Data/Mem, Math = User Def").
- A shift of the trace in horizontal or vertical direction ("TRACE CONFIG > Smooth Shift Hold > Shift Trace").

"All Data to Mem" stores the raw trace without the trace functions, "All Data & Func to Mem" stores the trace after it has been transformed using the trace functions.

Remote command:

`CALCulate<Chn>:MATH:MEMorize`

### Destination

Specifies whether data will be copied to existing memory traces ("Mem"), overwriting the previous values, or to "New" memory traces.

Remote command:

n/a

**Show / Hide All Data / Mem**

Displays or hides all data or memory traces. Hidden traces are not deleted.

Remote command:

`DISPlay[:WINDow<Wnd>]:TRACe<WndTr>:SHOW`

**Delete all Mem**

Deletes all memory traces in the active recall set.

**Tips:** Use "TRACE CONFIG > Traces > Delete Trace" to delete a (single) data trace.

Use the "Trace Manager" to hide traces in the diagrams.

Use the UNDO key to restore a trace that was unintentionally deleted.

Remote command:

`CALCulate:PARAmeter:DELeTe:MEMory`

**4.2.4.7 Trace Config > Time Domain**

Calculates and displays the results as a function of time.

The "Time Domain" and "Time Gate" features are part of option R&S ZNC-K2/  
R&S ZND-K2 "Time Domain Analysis".

**Background information**

Refer to [Chapter 3.7.5, "Time Domain Analysis"](#), on page 110.

For a comparison of the different transformation types and windows and for application examples please also refer to the application note 1EZ44\_OE which is posted on the R&S internet.

**Access:** TRACE > TRACE CONFIG key or Alt + Shift + D



### Time Domain

Selects the time domain representation for the active diagram area. The softkey is enabled if a linear frequency sweep ("CHANNEL > SWEEP > Sweep Type > Lin. Frequency") is active. The analyzer automatically quits time domain representation as soon as a different sweep type is selected.

The time domain results are obtained by transforming the measured frequency sweep data into the time domain using an appropriate mathematical transformation type and frequency window ("Impulse Response"). The sweep range and the output power for the active channel is still displayed below the diagram; the displayed time interval is shown in a second line:

Ch1	Start 9 kHz	—	Stop 8.5 GHz
Trc1	Start -1 ns	—	Stop 4 ns

### Trace settings in time domain representation

While the time domain representation is active the trace settings behave as follows:

- The "Start" and "Stop" settings in the "Time Gate" tab configure the time axis.
- All trace formats including the circular diagrams are available.
- Limit lines can be defined like the limit lines for time sweeps.
- The bandfilter search functions are available for the transformed trace.
- If marker coupling is active, then the markers in the time domain and in the frequency domain are coupled with each other.

The analyzer places no restriction on the measured quantities to be transformed into the time domain. Impedances and admittances are first converted back into the equivalent S-parameter, transformed, and restored after the transformation.

See also [Chapter 3.7.5.1, "Chirp z-Transformation"](#), on page 110.

Remote command:

```
CALCulate<Chn>:TRANSform:TIME:STATE
```

### Type

Selects a band pass or low pass time domain transform. See [Chapter 3.7.5.2, "Band Pass and Low Pass Mode"](#), on page 111.

To calculate a low pass transform the sweep points must be on a harmonic grid (otherwise the analyzer will only be able to calculate an approximate result and generate a warning). "Low Pass Settings"... opens a dialog to establish or change a harmonic grid (not available for memory traces).

See [Chapter 4.2.4.8, "Low Pass Settings \(Dialog\)"](#), on page 177

Remote command:

```
CALCulate<Chn>:TRANSform:TIME[:TYPE]
```

```
CALCulate<Chn>:TRANSform:TIME:STIMulus
```

### Impulse Response

Selects a window type which the R&S ZNC/ZND uses to filter the trace in the frequency domain. The drop-down list shows the impulse response of a constant trace over a finite sweep range (i.e. a rectangular function) that was filtered using the different available window types. The selected window is applied to the active trace.

See also [Chapter 3.7.5.3, "Windows in the Frequency Domain"](#), on page 112.



**Note:** The frequency domain window is used to filter the trace prior to the time domain transformation. An independent time gate ("TRACE CONFIG > Time Gate") can be used after the transformation in order to eliminate unwanted responses.

The analyzer always uses a "No Profiling (Rectangle)" window to calculate the time-gated frequency domain trace, see ["Time-Gated Frequency Domain Trace"](#) on page 115.

Remote command:

```
CALCulate<Chn>:TRANSform:TIME:WINDow
```

#### Side Lobe Level

Defines the side lobe suppression for an "Arbitrary Sidelobes (Dolph-Chebyshev)" window. The entered value is the ratio of the power of the central lobe to the power of the first side lobe in dB.

Remote command:

```
CALCulate<Chn>:TRANSform:TIME:DCHebyshev
```

#### Resolution Enh(ancement)

Broadens the frequency range that the analyzer considers for the time domain transform by a linear factor. A factor of 1 means that the original sweep range and the measured sweep points are used; no additional assumptions are made. With higher resolution enhancement factors, the measurement data is extrapolated using a linear prediction method. As a result, the resolution in time domain can be improved.

The ideal resolution enhancement factor depends on the properties of the DUT. In distance to fault measurements on cables, factors between 3 and 5 turned out to be a good choice.

Remote command:

```
CALCulate<Chn>:TRANSform:TIME:RESolution:EFACtor
```

#### 4.2.4.8 Low Pass Settings (Dialog)

The "Low Pass Settings" dialog defines the harmonic grid for low pass time domain transforms.



#### Background information

Refer to [Chapter 3.7.5.4, "Harmonic Grid"](#), on page 112.

---

**Access:** TRACE > TRACE CONFIG > Time Domain > Low Pass Settings...



### Set Harmonic Grid and Keep

The three buttons provide alternative algorithms for calculation of a harmonic grid, based on the current sweep points.

- Keep "Stop Frequency and Number of Points" calculates a harmonic grid based on the current stop frequency ("STIMULUS STOP") and the current number of sweep points ("CHANNEL SWEEP > Number of Points"). This may increase the frequency gap (the spacing between the equidistant sweep points, i.e. the sweep "Span" divided by the "Number of Points" minus one).
- Keep "Frequency Gap and Number of Points" calculates a harmonic grid based on the current stop frequency ("STIMULUS STOP") and the current frequency gap.
- Keep "Stop Frequency and Approximate Frequency Gap" calculates a harmonic grid based on the current stop frequency ("STIMULUS STOP"), increasing the number of points ("CHANNEL SWEEP > Number of Points") in such a way that the frequency gap remains approximately the same. This may increase the sweep time, due to the additional sweep points introduced.

The three grids can be calculated repeatedly in any order; the analyzer always starts from the original set of sweep points.

For more information refer to [Chapter 3.7.5.4, "Harmonic Grid"](#), on page 112.

Remote command:

```
CALCulate<Chn>:TRANSform:TIME:LPASs
```

### Automatic Harmonic Grid

If enabled (default) the frequency grid is automatically kept harmonic.

Remote command:

```
[SENSe<Ch>:]HARMonic:AUTO
```

### DC Value

The control elements define the measurement result at zero frequency and in the interpolation/extrapolation range between  $f = 0$  and  $f = f_{\min}$ . They are enabled after a harmonic grid has been established.

### Defining the low frequency sweep points

After calculating a harmonic grid, the analyzer must determine the value of the measured quantity at zero frequency and possibly at additional points in the range between  $f = 0$  and  $f = f_{\min}$ .

The following figure shows a scenario where the harmonic grid was calculated with fixed "Stop Frequency and Number of Points". The DC value and the values at the two additional red points must be extrapolated or interpolated according to the measured sweep points (blue dots) and the properties of the DUT.

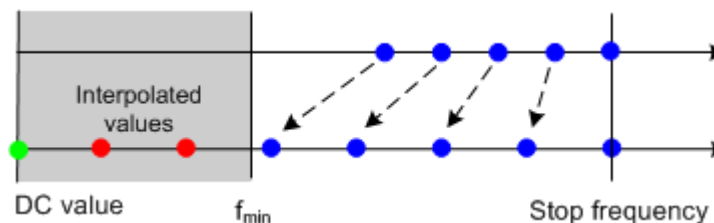

- If the properties of the DUT at  $f = 0$  are sufficiently well known, then it is recommendable to enter the DC value manually ("Manual Entry") and let the analyzer calculate the remaining values (red dots) by linear interpolation of the magnitude and phase.

**Examples:** At  $f = 0$  the reflection factor of an open-ended cable is 1. It is  $-1$  for a short-circuited cable and 0 for a cable with matched termination. If a cable with known termination is measured, then these real numbers should be entered as DC values.

The "Extrapolate" button initiates an extrapolation of the measured trace towards  $f = 0$  and overwrite the current DC value. This can be used for a consistency check.

- "Continuous Extrapolation" initiates an extrapolation of the measured trace towards lower frequencies, so that the missing values (green and red dots) are obtained without any additional input. The extrapolation is repeated after each sweep.

Remote command:

```
CALCulate<Chn>:TRANSform:TIME:LPASs:DCSParam
CALCulate<Chn>:TRANSform:TIME:LPASs:DCSParam:CONTinuous
CALCulate<Chn>:TRANSform:TIME:LPASs:DCSParam:EXTRapolate
CALCulate<Chn>:TRANSform:TIME:LPFRequency
```

#### 4.2.4.9 Trace Config > Time Gate

Defines and activates a time gate. An active time gate acts on the trace in time domain as well as in frequency domain representation. In time domain representation, you can use the time gate settings in order to eliminate unwanted responses in your signal.

After switching back to the frequency domain, you will receive the frequency response of your DUT without the contribution of the unwanted responses. The time gate is independent of the frequency window used to filter the trace prior to the time domain transformation.

The "Time Domain" and "Time Gate" features are part of option R&S ZNC-K2/R&S ZND-K2 "Time Domain Analysis".



### Background information

Refer to [Chapter 3.7.5.5, "Time Gates"](#), on page 114.

**Access:** TRACE > TRACE CONFIG key or Alt + Shift + D



### Time Gate

Enables or disables the time gate for the time domain and frequency domain traces. "Gat" is displayed in the trace list while the time gate is active.

Trc1 S21 dB Mag 10 dB / Ref 0 dB Gat

Remote command:

```
CALCulate<Chn>:FILTer[:GATE]:TIME:STATE
```

### Axis Pair

"Start" and "Stop" or "Center" and "Span" define the size of the time gate. The analyzer generates a warning if the selected time span exceeds the unambiguous range which is given by  $\Delta t = 1/\Delta f$ , where  $\Delta f$  is the spacing between two consecutive frequency points. Simply reduce the time span until the warning disappears.

Remote command:

```
CALCulate<Chn>:FILTer[:GATE]:TIME:CENTER
CALCulate<Chn>:FILTer[:GATE]:TIME:SPAN
CALCulate<Chn>:FILTer[:GATE]:TIME:START
CALCulate<Chn>:FILTer[:GATE]:TIME:STOP
```

### Show Range Limits

Displays or hides two red lines indicating the start and stop of the time gate in the diagram.

Remote command:

```
CALCulate<Chn>:FILTer[:GATE]:TIME:SHOW
```

### Bandpass / Notch

The filter type defines what happens to the data in the specific time region.

- A "Band Pass" filter passes all information in the specified time region and rejects everything else.
- A "Notch" filter rejects all information in the specified time region and passes everything else.

Remote command:

```
CALCulate<Chn>:FILTer[:GATE]:TIME[:TYPE]
```

### Shape

Selects a gate shape which the R&S ZNC/ZND uses to filter the trace in the time domain. The drop-down list visualizes how the time gate will affect a constant function after transformation back into the frequency domain. The selected window is applied to the active trace. The two red vertical lines represent the "Start" and "Stop" values defining the size of the time gate.

The R&S ZNC/ZND always uses a "Steepest Edges (Rectangle)" window to calculate the time-gated frequency domain trace, see "[Time-Gated Frequency Domain Trace](#)" on page 115.

See also [Chapter 3.7.5.5, "Time Gates"](#), on page 114.

Remote command:

```
CALCulate<Chn>:FILTer[:GATE]:TIME:SHAPE
```

```
CALCulate<Chn>:FILTer[:GATE]:TIME:WINDOW
```

### Side Lobe Level

Defines the side lobe suppression for an "Arbitrary Gate Shape (Dolph-Chebyshev)" gate. The entered value is the ratio of the power of the central lobe to the power of the first side lobe in dB.

Remote command:

```
CALCulate<Chn>:FILTer[:GATE]:TIME:DCHebyshev
```

## 4.2.4.10 Trace Config > Trace Statistics

Evaluates statistical and phase information of the entire trace or of a specific evaluation range and calculates the x-dB compression point.

**Access:** TRACE > TRACE CONFIG key or Alt + Shift + D



### Statistical Functions

The upper two softkeys in the "Trace Statistics" tab display or hide groups of statistical results. The values are based on all response values of the trace in the selected evaluation range ("Eval Range...").

Statistics: Trc1 (S21)	
Min	-15.2777 dB
Max	-1.9120 dB
Pk-Pk	13.3658 dB
Mean	-4.7478 dB
Std Dev	1.7521 dB
Rms	-4.4653 dB

Suppose that the trace in the evaluation range contains  $n$  stimulus values  $x_i$  and  $n$  corresponding response values  $y_i$  (measurement points). The statistical values are obtained as follows:

- "Min." and "Max." are the largest and the smallest of all response values  $y_i$ .
- "Peak-Peak" is the peak-to-peak value and is equal to the difference "Max. – Min."
- "Mean" is the arithmetic mean value of all response values:

$$\text{Mean} = \frac{1}{n} \sum_{i=1}^n y_i$$

- SDev is the standard deviation of all response values:

$$\text{Std. Dev.} = \sqrt{\frac{1}{n} \sum_{i=1}^n (y_i - \frac{1}{n} \sum_{i=1}^n y_i)^2}$$

- RMS is the root mean square (effective value) of all response values:

$$\text{RMS} = \sqrt{\frac{1}{n} \sum_{i=1}^n |y_i|^2}$$

**Note:** To calculate the Min., Max., Pk-Pk values and the SDev, the analyzer uses formatted response values  $y_i$  (see trace formats). Consequently, the mean value and the standard deviation of a trace depend on the selected trace format. In contrast, the RMS calculation is based on linear, unformatted values. The physical units for unformatted wave quantities is 1 Volt. The RMS value has zero phase. The selected trace format is applied to the unformatted RMS value, which means that the RMS result of a trace does depend on the trace format.

Remote command:

```
CALCulate<Chn>:STATistics[:STATe]
CALCulate<Chn>:STATistics:RESult?
CALCulate<Chn>:STATistics:MMPTpeak[:STATe]
CALCulate<Chn>:STATistics:MSTDdev[:STATe]
CALCulate<Chn>:STATistics:RMS[:STATe]
```

### Format

This determines how [Statistical Functions](#) for complex-valued traces (Smith, Polar) are calculated:

- ZVAB: the results are based on unformatted wave quantities (voltages)
- R + jX: the results are based on the resistance values R
- G + jB: the results are based on the conductance values G

In the two latter cases, the RMS value is not displayed.

Remote command:

```
CALCulate<Chn>:STATistics:FORMat
```

### Phase / EI Length

Displays or hides the phase delay ("Delay") and the electrical length ("EL") of the trace in the selected evaluation range ("Eval Range..."). The parameters are only available for trace formats that contain phase information, i.e. for the formats "Phase, Unwrapped Phase", and the polar diagram formats "Polar, Smith, Inverted Smith". Moreover, the sweep type must be a "frequency sweep", and the evaluation range must contain at least 3 measurement points.

Statistics: Trc1	(S21)
Phs Dly	273.3929 ps
EI Len	81.9611 mm

The phase parameters are obtained from an approximation to the derivative of the phase with respect to frequency in the selected evaluation range.

- "Delay" is the phase delay, which is an approximation to the group delay and calculated as follows:

$$PD = -\frac{\Delta \phi_{deg}}{360^\circ \cdot \Delta f}$$

where  $\Delta f$  is the width of the evaluation range and  $\Delta \Phi$  is the corresponding phase change. See also note on transmission and reflection parameters below.

- "EL" is the electrical length, which is the product of the phase delay times the speed of light in the vacuum.

If no dispersion occurs the phase delay is equal to the group delay. For more information refer to [Chapter 3.3.8, "Delay, Aperture, Electrical Length"](#), on page 62.

**Note:** To account for the propagation in both directions, the delay and the electrical length of a reflection parameter is only half the delay and the electrical length of a transmission parameter. The formula for PD above is for transmission parameters. See also "Length and delay measurement" in [Chapter 3.6.1.3, "Auto Length"](#), on page 104.

"Tip:" The phase evaluation can cause misleading results if the evaluation range contains a 360 deg phase jump. The trace format "Unwrapped Phase" avoids this behavior.

Remote command:

```
CALCulate<Chn>:STATistics[:STATe]
CALCulate<Chn>:STATistics:RESult?
CALCulate<Chn>:STATistics:EPDelay[:STATe]
```

### Flatness / Gain / Slope

Displays or hides trace parameters that the analyzer calculates for the selected evaluation range ("Eval Range...").

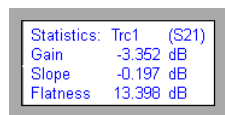

Statistics: Trc1 (S21)
Gain -3.352 dB
Slope -0.197 dB
Flatness 13.398 dB

Suppose that A and B denote the trace points at the beginning and at the end of the evaluation range, respectively.

- "Gain" is the larger of the two stimulus values of points A and B.
- "Slope" is the difference of the stimulus values of point B minus point A.
- "Flatness" is a measure of the deviation of the trace in the evaluation range from linearity. The analyzer calculates the difference trace between the active trace and the straight line between points A and B. The flatness is the difference between the largest and the smallest response value of this difference trace.

Remote command:

```
CALCulate<Chn>:STATistics[:STATe]
CALCulate<Chn>:STATistics:RESult?
CALCulate<Chn>:STATistics:SFLatness[:STATe]
```

### Compr Point / Value

Displays or hides all results related to the x-dB compression point of the trace, where x is the selected compression value. To obtain valid compression point results, a power sweep must be active, and the trace format must be "dB Mag".

The x-dB compression point of an S-parameter or ratio is the stimulus signal level where the magnitude of the measured quantity has dropped by x dB compared to its value at small stimulus signal levels (small-signal value). As an approximation for the small-signal value, the analyzer uses the value at the start level of the evaluation range ("Eval Range...").



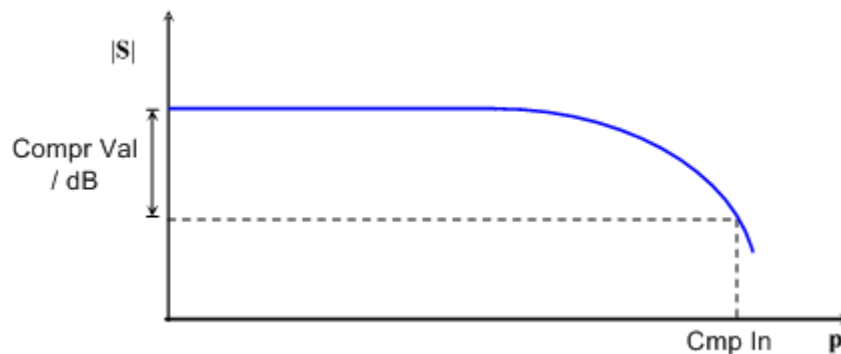

The compression point is a measure for the upper edge of the linearity range of a DUT. It is close to the highest input signal level for which the DUT shows a linear response ( $|a_n| \rightarrow x \cdot |a_n| \leftrightarrow |b_n| \rightarrow x \cdot |b_n|$ , so that the magnitude of all S-parameters remains constant).

When "Compression Point" is activated, a marker labeled "Cmp" is placed to the compression point with the smallest stimulus level. Moreover the movable "Trace Statistics" info field shows the numerical results of the compression point measurement:

Statistics: Trc1 (S21)
Cmp In -24.9 dBm
Cmp Out -45.7 dBm

- "Cmp In" is the stimulus level at the compression point in units of dBm. "Cmp In" always corresponds to the driving port level (e.g. the level from port no. j, if a transmission parameter  $S_{ij}$  is measured).
- "Cmp Out" is the sum of the stimulus level "Cmp In" and the magnitude of the measured response value at the compression point. The magnitude of a transmission S-parameter  $S_{ij}$  is a measure for the attenuation (or gain) of the DUT, hence: "Cmp Out = Cmp In + <Attenuation>". The example above is based on an attenuation of  $-20.8$  dB, hence "Cmp Out" =  $-24.9$  dB –  $20.8$  dB =  $-45.7$  dBm.

The info field shows invalid results ('---') if the wrong sweep type or trace format is selected, or if the trace contains no x-dB compression points in the selected evaluation range.

Remote command:

```
CALCulate<Chn>:STATistics:NLINear:COMP[:STATe]
CALCulate<Chn>:STATistics:NLINear:COMP:RESult?
CALCulate<Chn>:STATistics:NLINear:COMP:LEVel
CALCulate<Chn>:STATistics[:STATe]:AREA
```

### Decimal Places

Opens the "System Config" dialog to define the (maximum) number of fractional digits for setting values and measurement results. See also [Chapter 4.6.2.3, "User Interface"](#), on page 336.

#### 4.2.4.11 Evaluation Range (Dialog)

The "Evaluation Range" dialog defines the range for the "Trace Statistics" and certain marker search results (bandfilter and multiple peak search). The evaluation range is a continuous interval of the sweep variable.

See also [Chapter 4.2.4.10, "Trace Config > Trace Statistics"](#), on page 181 and [Chapter 4.2.6, "Marker Settings"](#), on page 210.

**Access:** TRACE > TRACE CONFIG > Trace Statistics > Eval Range...

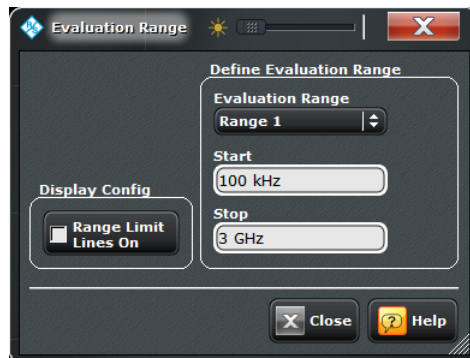

#### Evaluation Range

Selects a predefined evaluation range. Up to ten different ranges are available for each recall set. "Full Span" means that the search range is equal to the entire sweep range. The statistical and phase evaluation and the compression point measurement take into account all measurement points with stimulus values  $x_i$  between the "Start" and "Stop" value of the evaluation range:

"Start  $\leq x_i \leq$  Stop"

The evaluation ranges are defined similar to the marker search ranges. For more information see [Chapter 4.2.6.4, "Search Range \(Dialog\)"](#), on page 217.

**Note:** A restricted evaluation range is indicated in the "Trace Statistics" info field

```
Statistics (S21, Range 1)
Min      -15.4692 dB
Max      -4.0813 dB
Pk-Pk    11.3879 dB
```

Remote command:

```
CALCulate<Chn>:STATistics:DOMain:USER
CALCulate<Chn>:STATistics:DOMain:USER:START
CALCulate<Chn>:STATistics:DOMain:USER:STOP
```

#### Range Limit Lines on

Displays or hides the range limit lines in the diagram area. Range limit lines are two vertical lines at the Start and Stop values of the active evaluation range ("Range 1" to "Range 10").

Remote command:

```
CALCulate<Chn>:STATistics:DOMain:USER:SHOW
```

#### 4.2.4.12 Trace Config > Smooth Shift Hold

Provides various functions to modify the entire measured trace.



#### Trace functions and exported data

The analyzer can export the raw complex (unformatted) data or formatted data. The unformatted data are independent of all "Smooth Shift Hold" settings; see "[Formatted Values](#)" on page 193.

**Access:** TRACE > TRACE CONFIG key or Alt + Shift + D



#### Smoothing

Activates the smoothing function for the active trace, which may be a data or a memory trace. With active smoothing function, each measurement point is replaced by the arithmetic mean value of all measurement points located in a symmetric interval centered on the stimulus value. The width of the smoothing interval is referred to as the "Smoothing Aperture" and can be adjusted according to the properties of the trace.

**Tip:** The sweep average is an alternative method of compensating for random effects on the trace by averaging consecutive traces. Compared to smoothing, the sweep average requires a longer measurement time but does not have the drawback of averaging out quick variations of the measured values. See [Chapter 4.4.1.3, "Power Bw Avg > Average"](#), on page 234.

Remote command:

```
CALCulate<Chn>:SMOothing[:STATE]
```

#### Aperture

Defines how many measurement points are averaged to smooth the trace if smoothing is switched on. The "Smoothing Aperture" is entered as a percentage of the total sweep span.

An aperture of  $n\%$  means that the smoothing interval for each sweep point  $i$  with stimulus value  $x_i$  is equal to  $[x_i - \text{span} \cdot n/200, x_i + \text{span} \cdot n/200]$ , and that the result of  $i$  is replaced by the arithmetic mean value of all measurement points in this interval. The average is calculated for every measurement point. Smoothing does not significantly increase the measurement time.

**Tips:** Finding the appropriate aperture

A large smoothing aperture enhances the smoothing effect but may also average out quick variations of the measured values and thus produce misleading results.

To avoid errors, observe the following recommendations.

- Start with a small aperture and increase it only as long as you are certain that the trace is still correctly reproduced.
- As a general rule, the smoothing aperture should be small compared to the width of the observed structures (e.g. the resonance peaks of a filter). If necessary, restrict the sweep range or switch smoothing off to analyze narrow structures.

Remote command:

`CALCulate<Chn>:SMOothing:APERture` on page 476

### Hold

Selects the Max Hold (peak hold) or Min Hold function for the active trace, or disables both functions (Hold Off). With enabled Max Hold or Min Hold function, the displayed trace shows the maximum or minimum values that the analyzer acquired since the start of the measurement. The max hold and min hold trace is real, it is based on the magnitude of the trace values (the phase values are discarded).

The max hold or min hold process can be restarted any time using "Restart". It is also restarted automatically when the channel or trace settings are changed so that the previous measurement results are no longer compatible.

**Note:** A memory trace is unformatted by definition. Therefore, "Data --> Mem" stores the last measured trace instead of the real Max Hold or Min Hold trace.

Remote command:

`CALCulate<Chn>:PHOLd`

### Shift Trace > Stimulus

Shifts the active trace in horizontal direction, leaving the positions of all markers unchanged. The unit of the offset value depends on the sweep type.

**Note:**

"Shift Stimulus Value" can be used in Cartesian as well as in polar diagrams. The visible effect depends on the diagram type:

- In Cartesian diagrams, the trace is shifted relative to the markers and the x-axis.
- In polar diagrams, the trace is not affected, however, markers change their position.

Remote command:

`DISPlay[:WINDow<Wnd>]:TRACe<WndTr>:X:OFFSet`

### Shift Trace > Mag / Phase / Real / Imag

Modifies all points of the active trace by means of an added and/or a multiplied complex constant.

The units of the constants are adjusted to the format of the active trace. Setting all values to zero ("Shift Reset") restores the original trace.

The trace points are modified according to the following formula:

$$M_{new} = M_{old} \cdot 10^{<Magnitude>/20 \text{ dB}} a \cdot e^{j \cdot <Phase>/180^\circ} + <Real> + j <Imag>$$

The formula and the different constants are adjusted to the different display formats of a trace:

- The "Mag(nitude)" factor shifts a dB Mag trace in vertical direction, leaving the phase of a complex parameter unchanged.
- The "Phase" factor rotates a trace that is displayed in a polar diagram around the origin, leaving the magnitude unchanged.
- The "Real" added constant shifts a real trace in vertical direction, leaving the imaginary part unchanged.
- The "Imag(inary)" added constant shifts a imaginary trace in vertical direction, leaving the real part unchanged.

**Tip:** Shifting the trace by means of constant values is a simple case of trace mathematics. Use the "User Defined Math" dialog to define more complicated mathematical operations. See [Chapter 4.2.4.5, "User Def Math \(Dialog\)"](#), on page 170.

Remote command:

```
DISPlay[:WINDow<Wnd>]:TRACe<WndTr>:Y:OFFSet
```

#### 4.2.4.13 Trace Config > Trace Data

Stores one or several data or memory traces to a file or loads a memory trace from a file.



#### Background information

Refer to [Chapter 3.4.2, "Trace Files"](#), on page 68.

**Access:** TRACE > TRACE CONFIG key or Alt + Shift + D

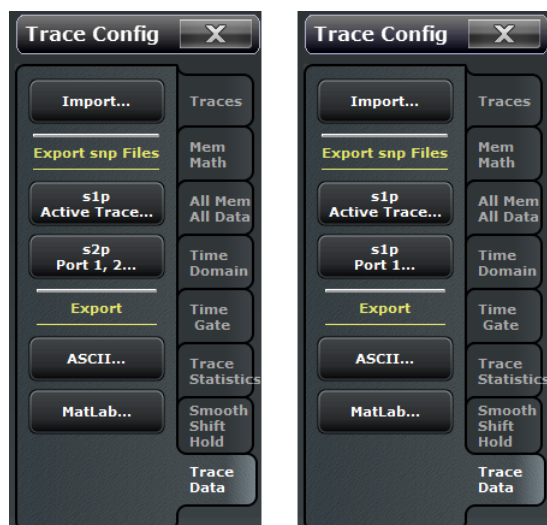

left = R&S ZNC or bidirectional R&S ZND  
 right = unidirectional R&S ZND

### Import...

Calls up a dialog to load a memory trace from a trace file. See [Chapter 4.2.4.14, "Import Complex Data \(Dialog\)"](#), on page 190.

Remote command:

`MMEMemory:LOAD:TRACe`

### Export...

Calls up a dialog to store data or memory traces to a trace file of the selected file format. See [Chapter 4.2.4.15, "Export Data \(Dialog\)"](#), on page 191

**Note:** For a unidirectional R&S ZND (see [Chapter 3.1.4.2, "R&S ZND: Unidirectional vs. Bidirectional Operation"](#), on page 16)  $S_{12}$  and  $S_{22}$  can not be measured and hence an export to `s2p` is not available.

Remote command:

`MMEMemory:STORe:TRACe`

`MMEMemory:STORe:TRACe:CHANnel`

`MMEMemory:STORe:TRACe:PORTs`

#### 4.2.4.14 Import Complex Data (Dialog)

The "Import Complex Data" dialog loads a memory trace from a trace file. Trace files are ASCII files with selectable file format. The loaded trace data is used to generate a memory trace which is coupled to the active data trace.



### Background information

Refer to [Chapter 3.4.2, "Trace Files"](#), on page 68.

**Access:** TRACE > TRACE CONFIG > Trace Data > Import...

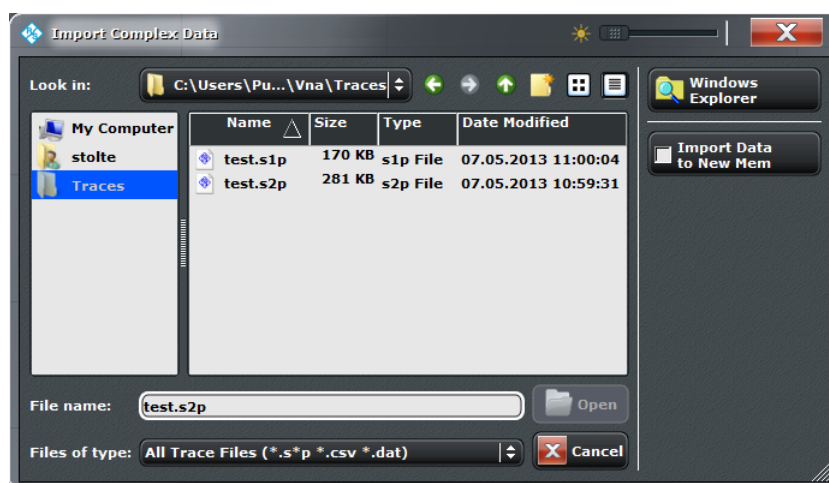

On loading data from a trace file with several traces, the analyzer displays a dialog to select one or more of the traces stored in the file (see [Chapter 4.2.4.16, "Select](#)

[Parameters \(Dialog\)](#)", on page 194). E.g. for an \*.s2p Touchstone file, the box offers all four 2-port S-parameters (see [Chapter 3.4.2.1, "Touchstone Files"](#), on page 69).

Coupling between the imported memory trace and the active data trace implies that the stimulus values of the imported data and of the active trace must be compatible. Compatibility means that the "Sweep Type" of the two traces must match; the position and number of the sweep points do not have to be the same.

The analyzer checks for compatibility before importing data. The "Select Parameter" box remains empty if the selected files contains no compatible data.

"Import Complex Data" is a standard "Open File" dialog with an additional button.

#### Import Data to New Mem

Qualifies whether the loaded data overwrite the active memory trace (box unchecked, analogous to "Data -> Mem" with selected memory trace) or whether they are used to generate a new memory trace (box checked, analogous to "Data -> Mem" with selected "New" memory trace).

Remote command:

`MMEMoRY:LOAD:TRACe`

#### 4.2.4.15 Export Data (Dialog)

The "Export Data - <file type>" dialog stores data or memory traces to a trace file. Trace files are ASCII files with selectable file format.

Data export can serve many purposes, e.g.:

- To process and evaluate measurement data in an external application.
- To store measurement data and re-import it in a future measurement session.



#### Background information

Refer to the following sections:

- [Chapter 3.4.2, "Trace Files"](#), on page 68.
- [Chapter 3.4.2.3, "Finding the Best File Format"](#), on page 72

---

**Access:** TRACE > TRACE CONFIG > Trace Data > s1p Active Trace...

and all other "Export snp Files " and "Export" functions

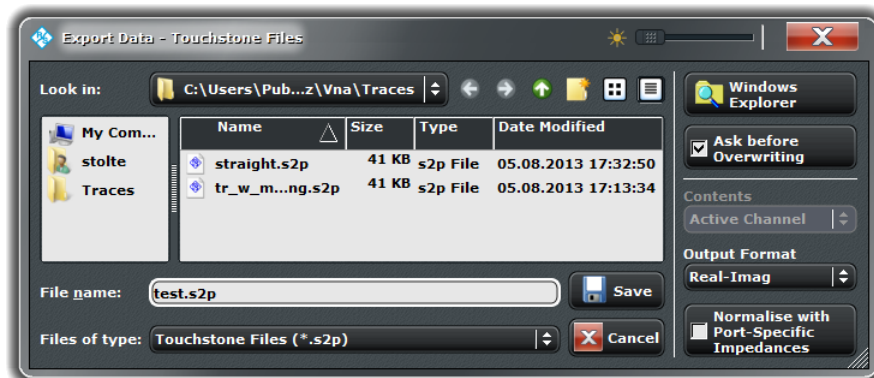

For a unidirectional R&S ZND export to s2p is not available.

"Export Data" is a standard "Save File" dialog with a number of additional buttons to specify the export options. Many options depend on the selected export file format ("Files of Type"). The displayed controls change accordingly.

The export options are remembered when the dialog is closed.

#### Ask before Overwriting

Activates a message box to be displayed before an older trace file with the same file name and directory is overwritten.

#### Contents

Selects only the active trace or all traces of the active channel (including all data and memory traces) or all traces in all channels for data export to an ASCII (\*.csv) or Matlab (\*.dat) file.

For Touchstone file export, it is possible to export the traces in the active channel or in all channels. See also ["Conditions for Touchstone file export"](#) on page 70.

#### Output Format

For Touchstone file export only: Selects the format of the exported raw, complex measurement values. The exported values can be represented by the real and imaginary parts, the linear magnitude and phase, or dB magnitude and phase; see also ["Formatted Values"](#) on page 193.

Export of [Formatted Values](#) is not available for Touchstone files.

#### Normalize with Port-Specific Impedances

For Touchstone file export only: activate this in order to renormalize according to the port-specific reference impedances instead of a common target impedance (see ["Renormalization of S-parameters"](#) on page 71).

#### Add Ref Impedances

For ASCII (\*.csv) or Matlab (\*.dat) files only: Includes the reference impedances  $Z_0$  for all analyzer ports in the file header.



### Formatted Values

For ASCII (\*.csv) or Matlab (\*.dat) files only: Selects the format for the exported trace data.

- **Check box cleared (off):** Export the raw complex (unformatted) measurement values, represented by the real and imaginary parts, the linear magnitude and phase, or dB magnitude and phase.  
The exported complex trace values are the values at the beginning of the trace data flow. None of the following stages (trace mathematics, shift, time domain gate, trace formatting and smoothing) affects the exported data. "Save" writes the raw stimulus values (frequency/power/time, according to the sweep type) and the raw, complex measurement points to a file. See [Chapter 3.1.5, "Data Flow"](#), on page 18. Export of complex data is available for all trace file types.
- **Check box selected (on):** Export the the values as they are displayed in the diagram, e.g. export the logarithmic magnitude, if trace format "dB Mag" is selected. The trace file does not necessarily contain the full (complex) information about the trace.  
For trace formats involving Cartesian diagrams (dB Mag, Real, Imag...), the stimulus value and a single real response value is exported. For circular diagrams, both the real and imaginary part of the response value is exported.  
The trace values are the fully processed values as they appear in the diagram area. They correspond to the results in the marker info field. All possible stages of the trace data flow (e.g. trace formats, trace mathematics, time domain transform, shift, smoothing) are taken into account. Some trace functions (e.g. time scale, shift stimulus) also affect the stimulus values.  
Export of formatted data is not available for Touchstone files.

### Field Separator

For ASCII (\*.csv) or Matlab (\*.dat) files only: Defines the separator that the analyzer uses to separate different numbers in each line of the file.

### Decimal Separator

For ASCII (\*.csv) files only: Selects either the "Point" or the "Comma" (if needed to process the exported data with an external application) as a separator for decimal numbers.

### Save

Stores the trace data, according to the selected options.

**Tip:** Note the conditions described in ["Conditions for Touchstone file export"](#) on page 70.

Remote command:

`MMEMemory:STORe:TRACe:PORTs`

`MMEMemory:STORe:TRACe`

`MMEMemory:STORe:TRACe:CHANnel`

#### 4.2.4.16 Select Parameters (Dialog)

The "Select Parameters" dialog provides a selection of measurement results (e.g. S-parameters) or traces, e.g. for trace import, import of power correction coefficients, limit line import.

**Access:** The dialog may be called from several dialogs, e.g. "TRACE > TRACE CONFIG > Trace Data > Import...".

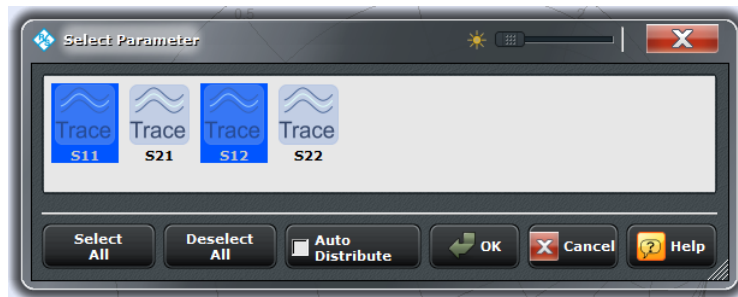

##### Select All / Deselect All

During trace data import, selects/deselects all traces contained in the opened trace file.

##### Auto Distribute

Available for trace data import only.

If checked, an imported trace for  $S_{ij}$  is imported as a memory trace into all diagrams currently displaying  $S_{ij}$ .

Remote command:

[MMEemory:LOAD:TRACe:AUTO](#)

### 4.2.5 Lines Settings

The commands in the "Lines" softtool define limits for the measurement results, visualize them in the diagrams and activate/deactivate the limit check. The analyzer provides upper, lower, ripple and circle limits. Besides this the "Lines" softtool provides functions to limit polar diagrams to a user-defined "Display Circle" and to add a user-defined horizontal lines to cartesian diagrams.



#### Background information

Refer to [Chapter 3.4.1, "Limit Check"](#), on page 63.

#### 4.2.5.1 Lines > Limit Test

Defines limit lines for the measurement results (upper and lower limits), visualizes them in the diagrams and activates/deactivates the limit check.

Limit lines are available for all cartesian diagram types (TRACE > FORMAT); "dB Mag" limits can also be checked in polar diagrams (Smith, Polar).



### Background information

Refer to [Chapter 3.4.1, "Limit Check"](#), on page 63.

**Access:** TRACE > LINES key or Alt + Shift + E



### Show Limit Line

Shows or hides the limit line associated with the active trace in a Cartesian diagram area.



The limit line colors are defined in the "Define User Color Scheme" dialog ("SYSTEM > DISPLAY > Config > Define User Color..."). You can choose between various options:

- Display upper and lower limit lines with different colors.
- Assign the same color to traces and associated limit lines.
- Assign different colors to limit line segments with disabled limit check.

**Note:** Display of the limit line and limit check are independent of each other: Hiding the limit line does not switch off the limit check.

Remote command:

`CALCulate<Chn>:LIMit:DISPlay[:STATe]`

### Limit Check

Switches the limit check of the active trace on or off.

When the limit check is switched on, a movable "PASS" or "FAIL" message is displayed in the diagram. If the limit check fails at a measurement point, the point is marked with a colored square. The "Limit Fail Trace" color is defined in the "Define User Color Scheme" dialog ("Display > Display Config. > Define User Color..."). An acoustic signal ("Global Beep") and a TTL signal indicating pass or fail can be generated in addition.

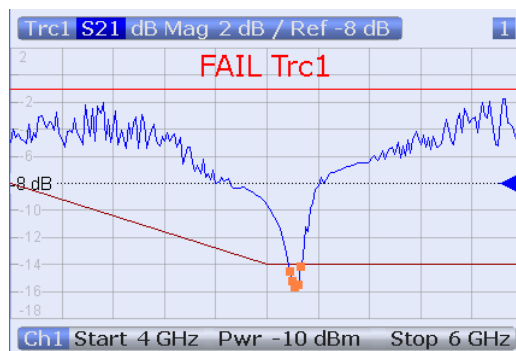

The appearance of the limit fail symbols is defined in the "Define User Color Scheme" dialog ("SYSTEM > DISPLAY > Config > Define User Color..."). You can choose between various options:

- Change the trace color between failed measurement points.
- Show or hide the colored squares.

#### Note:

- Limit check and display of the limit lines are independent of each other: With disabled limit check, the limit line can still be displayed. If no limit lines are defined for the active trace, the limit check can be switched on but will always PASS the trace.
- Limit lines in "dB Mag" format are also valid for polar diagrams: if the corresponding limit check is enabled it will show the correct PASS/FAIL state and limit fail symbols (if any).

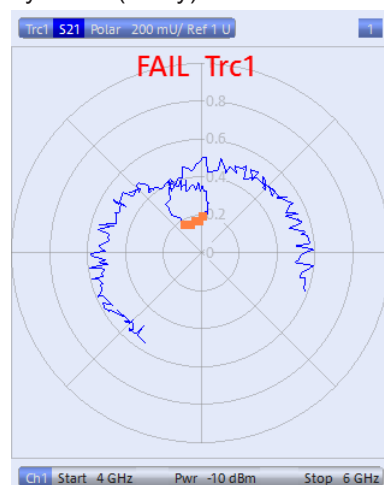

Figure 4-1: dB Mag limit line check in polar diagrams

If enabled, the [Circle Test](#) will be evaluated as well.

Remote command:

```
CALCulate<Chn>:LIMit:STATe
CALCulate<Chn>:LIMit:LOWer:STATe
CALCulate<Chn>:LIMit:UPPer:STATe
CALCulate<Chn>:LIMit:FAIL?
CALCulate:LIMit:FAIL:ALL?
CALCulate<Chn>:LIMit:STATe:AREA
```

### Limit Fail Beep

Activates or deactivates the fail beep. The fail beep is a low-tone acoustic signal that is generated each time the analyzer detects an exceeded limit. No fail beep can be generated if the limit check is switched off.

Remote command:

```
CALCulate<Chn>:LIMit:SOUNd[:STATe]
```

### Clear Test

Resets the limit check results.

Remote command:

```
CALCulate<Chn>:LIMit:CLEar
```

### Global Check

Activates or deactivates the global limit check including upper/lower limits and ripple limits. The global limit check is a composite limit check over all traces of the current recall set. The result of the global check appears in a semi-transparent popup box whenever "Global Limit Check" is selected.



- "PASS "represents pass for all traces with enabled limit check. A trace without limit lines or with disabled individual limit check always passes the global check.
- "FAIL" means that the limit check for one or more traces failed.

Remote command:

```
CALCulate:CLIMits:FAIL?
```

**TTL 1 / 2 Pass**

Assigns the active trace to the low-voltage (3.3 V) TTL output signals at the "USER PORT" connector (see [Chapter 9.1.1.1, "USER PORT"](#), on page 803). To generate the signals, the limit check of the active trace must be switched on.

- If "TTL 1 Pass" is selected and the active trace passes the limit check (including upper/lower limits and ripple limits), then the TTL signal is applied to pin 13 of the "USER PORT" connector.
- If "TTL 2 Pass" is selected and the active trace passes the limit check (including upper/lower limits and ripple limits), then the TTL signal is applied to pin 14 of the "USER PORT" connector.

If the active trace exceeds the limits, then no TTL signal is generated. It is possible to activate both pass/fail signals for the same trace or assign several traces to a signal.

**Monitoring several traces**

If a channel contains several traces, it is possible to assign them one after another to each pass/fail signal. The procedure divides the traces of the channel into four groups that are either assigned to signal 1, to signal 2, to both signals, or to none of them.

If several traces with independent limit check are assigned to a pass/fail signal, then the TTL signal is generated only if all traces are within limits. It is switched off as soon as one trace exceeds the limits.

**Application: Graduated limit check**

The two pass/fail signals can be used to distinguish three quality levels of a DUT. The test is performed with a looser and a tighter set of limit lines that are assigned to two traces with identical channel and trace settings. The limit check for the two traces is monitored by means of the signals "TTL Out Pass 1 /TTL Out Pass 2", respectively.

- If the DUT is passed in both limit checks, the quality is good.
- If the DUT is failed in the limit check with tighter limits, the quality is still sufficient.
- If the DUT is failed in both limit checks, the quality is poor.

Instead of using two traces, it is possible to consider two groups of traces that are assigned to "TTL 1 Pass" and "TTL 2 Pass".

Remote command:

```
CALCulate<Chn>:LIMit:TTLout<Pt>[:STATe]
```

**Shift Lines**

By setting the "Stimulus" and "Response" values it is possible to shift a previously defined limit line in x and y direction, respectively, without having to redefine the constituent line segments.

Remote command:

```
CALCulate<Chn>:LIMit:CONTRol:SHIFt
```

```
CALCulate<Chn>:LIMit:UPPer:SHIFt
```

```
CALCulate<Chn>:LIMit:LOWer:SHIFt
```

**4.2.5.2 Define Limit Lines (Dialog)**

The "Define Limit Lines" dialog defines the limit lines for the active trace on a segment-by-segment basis. In each segment the limit line is defined as a straight line connecting two points.



### Creating limit lines with minimum effort

Choose one of the following methods to efficiently create and handle limit lines:

- To define limit lines with only a few segments, use "Add Segment" and edit each segment in the segment table individually.
- Select a data or memory trace as a limit line ("Import Trace...") or import a trace stored in a file ("Import File...").
- Save your limit lines to a file so you can re-use or modify them later sessions ("Save Limit Line...", "Recall Limit Line...").



### Background information

Refer to [Chapter 3.4.1, "Limit Check"](#), on page 63.

**Access:** TRACE > LINES > Limit Test > Define Limit Line...

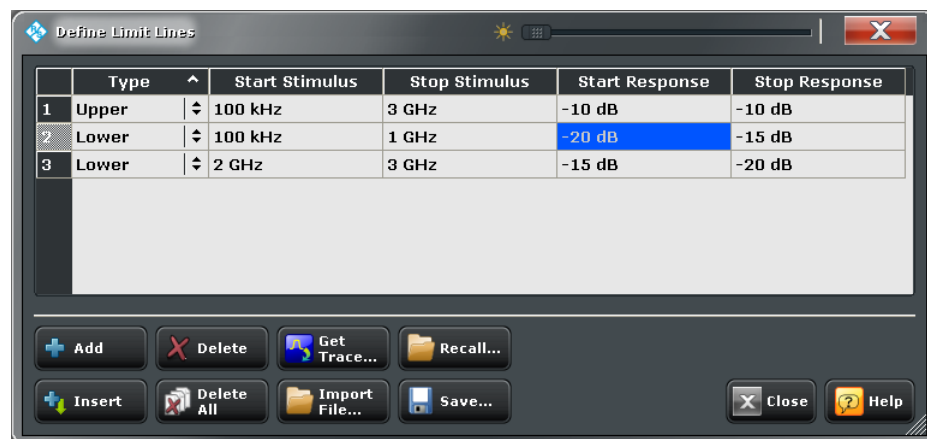

The "Define Limit Lines" dialog contains a table to edit the individual segments of the limit lines. The buttons below the table extend or shorten the segment list.

### Segment List

Defines the individual limit line segments.

The table contains an automatically assigned current number for each segment plus the following editable columns:

- "Type" indicates whether the segment belongs to an "Upper" or a "Lower" limit line, or if the limit check at the segment is switched "Off". Switching off the limit check does not delete the segment but changes its screen color.
- "Start Stimulus" is the stimulus (x-axis) value of the first point of the segment.
- "Stop Stimulus" is the stimulus (x-axis) value of the last point of the segment.
- "Start Response" is the response (y-axis) value of the first point of the segment.
- "Stop Response" is the response (y-axis) value of the last point of the segment. The limit line segment is calculated as a straight line connecting the two points (<Start Stimulus>, <Start Response>) and (<Stop Stimulus>, <Stop Response>); see [Chapter 3.4.1.1, "Rules for Limit Line Definition"](#), on page 64.

Remote command:

```
CALCulate<Chn>:LIMit:SEGment:COUNT?
CALCulate<Chn>:LIMit:SEGment<Seg>:TYPE
CALCulate<Chn>:LIMit:SEGment<Seg>:STIMulus:START
CALCulate<Chn>:LIMit:SEGment<Seg>:STIMulus:STOP
CALCulate<Chn>:LIMit:SEGment<Seg>:AMPLitude:START
CALCulate<Chn>:LIMit:SEGment<Seg>:AMPLitude:STOP
CALCulate<Chn>:LIMit:CONTRol[:DATA]
CALCulate<Chn>:LIMit:CONTRol:SHIFt
CALCulate<Chn>:LIMit:DATA
CALCulate<Chn>:LIMit:LOWer[:DATA]
CALCulate<Chn>:LIMit:LOWer:SHIFt
CALCulate<Chn>:LIMit:UPPer[:DATA]
CALCulate<Chn>:LIMit:UPPer:FEED
```

#### Add / Insert / Delete / Delete All

The first four buttons below the segment list extend or shorten the list. The analyzer places no restriction on the number of segments in a limit line.

- **Add** adds a new segment to the end of the list. The new segment extends from the "Stop Stimulus" value of the last segment to the end of the sweep range. Its response values are equal to the "Stop Response" value of the last segment.
- **Insert** adds a new segment before the active segment (marked by a blue background in the first column of the segment list). The new segment extends from the "Stop Stimulus" value of the segment before the active segment to the "Start Stimulus" value of the active segment. Its response values are equal to the "Start Response" value of the active segment. The segment numbers in the list are adapted.  
If no segment is active, "Insert" is equivalent to "Add".
- **Delete** removes the selected segment from the list.
- **Delete All** clears the entire segment list so it is possible to define or load a new limit line.

Remote command:

```
CALCulate<Chn>:LIMit:DELeTe:ALL
```

#### Recall / Save Limit Line...

The buttons open an Open File / Save File dialog to load a limit line from a limit line file or store the current limit line configuration to a file.

Limit line files are ASCII files with the default extension \*.limit and a special file format. See [Chapter 3.4.1.4, "File Format for Limit Lines"](#), on page 67.

Remote command:

```
MMEMory:LOAD:LIMit
MMEMory:STORe:LIMit
```

#### Import Trace / File...

The buttons open a dialog to load a limit line from a data or memory trace in the active recall set or from a trace which has been stored to a file (see [Chapter 4.2.4.13, "Trace Config > Trace Data"](#), on page 189).



Imported traces are polygonal curves with  $n$  points and  $n - 1$  segments. The number of points  $n$  is set via "CHANNEL > SWEEP > Sweeps > Number of Points". The  $n - 1$  segments are appended to the current segment table for further editing. Existing limit line segments are not overwritten.

The import dialogs contain a list of all available traces or files and the following file import settings.

- "Offsets" contains two input fields to define constant offset values for all imported segments. The "Response" offset shifts all segments in vertical direction, the "Stimulus" offset shifts them in horizontal direction. The offsets are added to the start and stop values of all segments.
- "Type" defines whether the imported segments belong to the "Upper" or "Lower" limit line. A third option is to import the segments but disable the limit check ("Off").

Remote command:

```
CALCulate<Chn>:LIMit:LOWer:FEED
```

```
CALCulate<Chn>:LIMit:UPPer:FEED
```

#### 4.2.5.3 Lines > Ripple Test

Defines ripple limits for the measurement results, visualizes them in the diagrams and activates/deactivates the ripple limit check. A ripple test is a special type of limit test where the maximum **difference** between the largest and the smallest response value of the trace must not exceed the specified limit.

Ripple limit lines are available for all Cartesian diagram types (TRACE > FORMAT). For polar diagrams, the functions of the "Ripple Test" softtool except the "Global Check" are grayed. The ripple limit lines are hidden and the limit check is disabled when a Cartesian trace format is replaced by a polar diagram.



#### Background information

Refer to [Chapter 3.4.1, "Limit Check"](#), on page 63.

**Access:** TRACE > LINES key or Alt + Shift + E

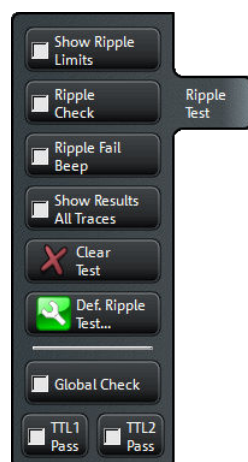

Some of the softkeys are coupled to the softkeys in the "Limit Test" tab and provide identical results:

- [Global Check](#)
- [TTL 1 / 2 Pass](#)

### Show Ripple Limits

Shows or hides the ripple limit lines associated with the active trace in a Cartesian diagram area. The vertical positions of the ripple lines are re-calculated after each sweep; only their stimulus range and distance (the ripple limit) is fixed.

#### Note:

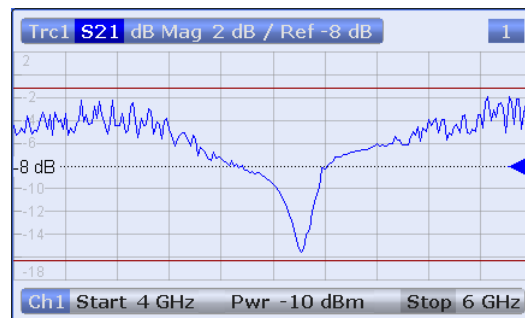

Display of the ripple limit line and limit check are independent of each other: Hiding the limit line does not switch off the limit check.

Remote command:

`CALCulate<Chn>:RIPple:DISPlay[:STATe]`

### Ripple Check

Switches the ripple limit check of the active trace on or off.

When the limit check is switched on, a movable info field shows the pass/fail information and the measured ripple in each ripple limit range. If the ripple limit check fails at a measurement point, the point is marked with a colored square. The "Limit Fail Trace" color is defined in the "Define User Color Scheme" dialog ("Display > Display Config. > Define User Color..."). An acoustic signal ("Global Beep") and a TTL signal indicating pass or fail can be generated in addition.

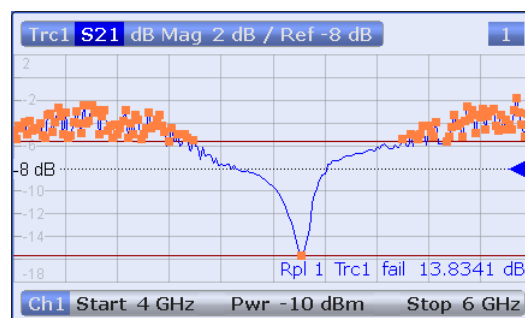

**Note:** Ripple limit check and display of the ripple limit lines are independent of each other: With disabled limit check, the limit line can still be displayed. If no limit lines are defined for the active trace, the limit check can still be switched on but the info field will display a warning ("No ripple defined!").

Remote command:

```
CALCulate<Chn>:RIPple:STATe
CALCulate<Chn>:RIPple:FAIL?
CALCulate:RIPple:FAIL:ALL?
CALCulate<Chn>:RIPple:SEGment<Seg>:RESult?
CALCulate<Chn>:RIPple:STATe:AREA
```

### Ripple Fail Beep

Activates or deactivates the fail beep. The fail beep is a low-tone acoustic signal that is generated each time the analyzer detects an exceeded ripple limit. No fail beep can be generated if the ripple limit check is switched off.

Remote command:

```
CALCulate<Chn>:RIPple:SOUNd[:STATe]
```

### Show Results All Traces

Shows or hides the info fields for all traces in the active recall set for which a limit check is enabled, irrespective of the active trace. If "Show Results All Traces" is disabled (and the ripple check is on), the info field for the active trace is displayed only.

Remote command:

```
CALCulate:RIPple:DISPlay:RESult:ALL[:STATe]
```

### Clear Test

Resets the limit check results.

Remote command:

```
CALCulate<Chn>:RIPple:CLEar
```

#### 4.2.5.4 Define Ripple Test (Dialog)

The "Define Ripple Test" dialog defines the ripple limits for the active trace on a range-by-range basis. A separate ripple limit can be assigned to each range.



#### Defining ripple limits with minimum effort

Choose one of the following methods to efficiently create and handle ripple limit ranges:

- To configure a limit test with only a few ranges, use "Add" and edit each range in the table individually.
- Use the "Align All" button to create non-overlapping, contiguous ranges of equal width.
- Save your ripple ranges to a file so you can re-use or modify them later sessions ("Save Ripple Test...", Recall Ripple Test...").



#### Background information

Refer to [Chapter 3.4.1, "Limit Check"](#), on page 63.

**Access:** TRACE > LINES > Ripple Test > Def. Ripple Test...

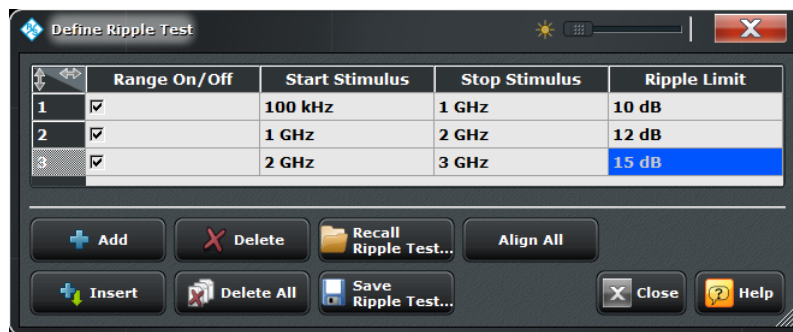

The "Define Ripple Test" dialog contains a table to edit the individual ranges of the ripple check ranges. The buttons below the table extend, shorten, or re-order the range list and save/recall ripple test data.

### Range List

Defines the individual ripple limit ranges.

The table contains an automatically assigned current number for each range plus the following editable columns:

- "Range On/Off" enables or disables the ripple limit check in each range. Disabling the ripple limit check does not delete the range but hides the entry in the info field.
- "Start Stimulus" is the smallest stimulus (x-axis) value of the range.
- "Stop Stimulus" is the largest stimulus (x-axis) value of the range.
- "Ripple Limit" is the maximum allowed difference between the largest and the smallest trace value in the range.

The ripple limit range is displayed as two parallel, horizontal lines in the diagram. "Stop Stimulus" – "Start Stimulus" is the length of both lines (if the range is within the sweep range); "Ripple Limit" is their vertical distance. See [Chapter 3.4.1.2, "Rules for Ripple Test Definition"](#), on page 65.

Remote command:

```
CALCulate<Chn>:RIPple:SEGment<Seg>[:STATE]
CALCulate<Chn>:RIPple:SEGment<Seg>:STIMulus:START
CALCulate<Chn>:RIPple:SEGment<Seg>:STIMulus:STOP
CALCulate<Chn>:RIPple:SEGment<Seg>:LIMit
CALCulate<Chn>:RIPple:SEGment:COUNT?
```

### Add / Insert / Delete / Delete All / Align All

The first four buttons below the range list extend, shorten, or re-order the list.

- **Add** adds a new range to the list. The new range is inserted after the previously selected range. The current range numbers are adapted; the start and stop stimulus values are set so that an overlap is avoided. Moreover, the ripple limit is estimated according to the measured ripple of the trace in the created range. The analyzer places no restriction on the number of ranges assigned to each trace.
- **Insert** adds a new range before the active range (marked by a blue background in the first column of the range list). The new range extends from the "Stop Stimulus" value of the range before the active range to the "Start Stimulus" value of the active range. Its ripple limit is estimated according to the measured ripple of the trace in the created range. The range numbers in the list are adapted. If no range is active, "Insert" is equivalent to "Add".

- **Delete** removes the selected range from the list.
- **Delete All** clears the entire range list so it is possible to define or load a new ripple limit line.
- **Align All** subdivides the entire sweep range into contiguous ripple limit ranges of equal width. The ripple limits are estimated according to the measured ripple of the trace in the created ranges.

Remote command:

```
CALCulate<Chn>:RIPPlE:CONTRol:DOMain
```

```
CALCulate<Chn>:RIPPlE:DATA
```

```
CALCulate<Chn>:RIPPlE:DELeTE:ALL
```

#### Recall / Save Ripple Test...

The buttons open an Open File / Save File dialog to load a ripple limit line from a ripple limit file or store the current ripple limit configuration to a file.

Ripple limit files are ASCII files with the default extension \*.ripple and a special file format. See [Chapter 3.4.1.5, "File Format for Ripple Limits"](#), on page 68.

Remote command:

```
MMEMory:LOAD:RIPPlE
```

```
MMEMory:STORe:RIPPlE
```

#### 4.2.5.5 Circle Test

Defines circular limit lines for the measurement results in polar diagrams ("Polar", "Smith", "Inverted Smith"), visualizes them in the diagram and activates/deactivates the circle limit check.

Most of the control elements in the "Circle Test" tab are unavailable unless the active diagram is a circular diagram.



#### Background information

Refer to [Chapter 3.4.1.3, "Circle Limits"](#), on page 66.

---

**Access:** TRACE > LINES key or Alt + Shift + E



Some of the softkeys are coupled to the softkeys in the "Limit Test" tab and provide identical results:

- [Global Check](#)
- [TTL 1 / 2 Pass](#)

### Show Limit Circle

Shows or hides the limit line associated with the active trace in a polar diagram area.

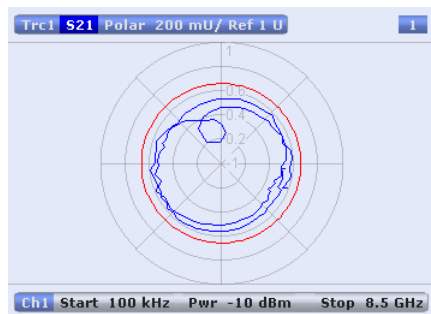

The limit line colors are defined in the "Define User Color Scheme" dialog ("Display > Config > Define User Color..."). You can choose between various options:

- Assign the same color to traces and associated limit lines.
- Assign different colors to limit line segments with disabled limit check.

**Note:** Display of the limit line and limit check are independent of each other: Hiding the limit line does not switch off the limit check.

Remote command:

```
CALCulate<Chn>:LIMit:CIRCle:DISPlay[:STATe]
```

### Limit Check

Switches the limit check of the active trace on or off.

When the limit check is switched on, a movable "PASS" or "FAIL" message is displayed in the diagram. If the limit check fails at a measurement point, the point is marked with a colored square. The "Limit Fail Trace" color is defined in the "Define User Color Scheme" dialog ("Display > Display Config. > Define User Color..."). An acoustic signal ("Global Beep") and a TTL signal indicating pass or fail can be generated in addition.

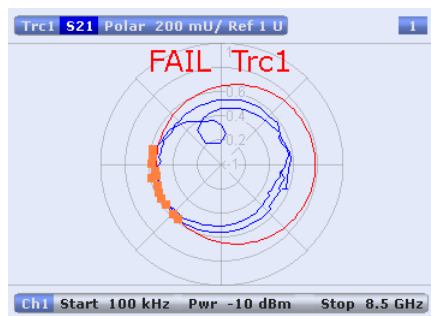

The appearance of the limit fail symbols is defined in the "Define User Color Scheme" dialog ("Display > Config > Define User Color..."). You can choose between various options:

- Change the trace color between failed measurement points.
- Show or hide the colored squares.

**Note:**

- Limit check and display of the limit lines are independent of each other: With disabled limit check, the limit line can still be displayed. If no limit lines are defined for the active trace, the limit check can be switched on but will always PASS the trace.
- If enabled, dB mag **limit lines** will also be checked.

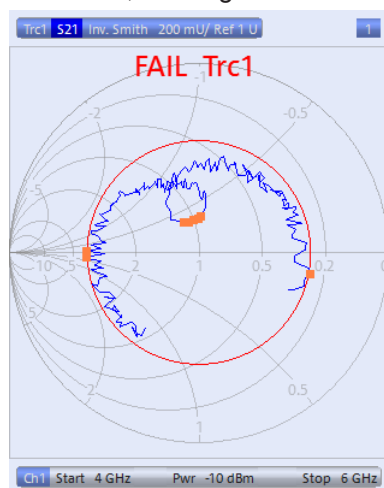

**Figure 4-2: Simultaneous "dB Mag" limit line and circle check**

Remote command:

```
CALCulate<Chn>:LIMit:CIRClE[:STATe]
CALCulate<Chn>:LIMit:CIRClE:FAIL?
CALCulate:LIMit:CIRClE:FAIL:ALL?
```

**Limit Fail Beep**

Activates or deactivates the fail beep. The fail beep is a low-tone acoustic signal that is generated each time the analyzer detects an exceeded limit. No fail beep can be generated if the limit check is switched off.

Remote command:

```
CALCulate<Chn>:LIMit:CIRClE:SOUNd[:STATe]
```

**Clear Test**

Resets the limit check results.

Remote command:

```
CALCulate<Chn>:LIMit:CIRClE:CLEAr
```

**Draw Circle**

Activates touchscreen operation; tap the diagram at one border of the limit circle and draw the circle to the required size and position.

Remote command:

n/a

**Radius / Center X/Y**

Defines the limit circle by its radius and its center on the x-axis and y-axis.

Remote command:

```
CALCulate<Chn>:LIMit:CIRClE:DATA
```

**4.2.5.6 Display Circle**

The "Display Circle" functionality allows to limit results displayed in the complex plane (Smith, Polar) to a user-defined circle. At the same time the active limit tests (line, circle) are restricted to the configured Display Circle.

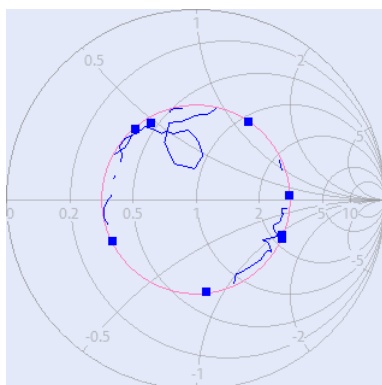

The controls on this tab are active only if the active trace is currently displayed in complex format.



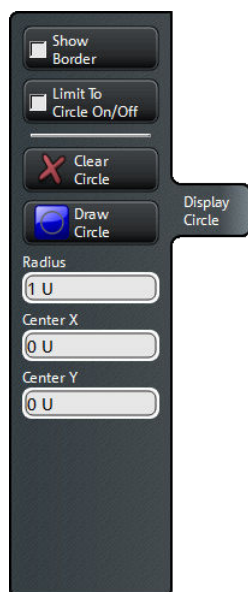

### Show Border

If enabled, the border of the Display Circle is shown whenever the related trace is displayed in complex format. The border color can be modified by a user-defined color scheme (Element "Horizontal Line / Vertical Range Lines").

Remote command:

```
CALCulate<Chn>:LIMit:DCIRcle:DISPlay[:STATe]
```

### Limit to Circle On/Off

If enabled, only trace points within the configured Display Circle are shown whenever the related trace is displayed in complex format.

Remote command:

```
CALCulate<Chn>:LIMit:DCIRcle[:STATe]
```

### Clear Circle

Resets the Display Circle to its default configuration (unit circle; show border: off; limit to circle: off)

Remote command:

```
CALCulate<Chn>:LIMit:DCIRcle:CLEar on page 425
```

### Draw Circle | Radius, Center X, Center Y

Defines the Display Circle - either by drawing it in the diagram area or by providing its radius and center

Remote command:

```
CALCulate<Chn>:LIMit:DCIRcle:DATA on page 425
```

#### 4.2.5.7 Lines > Horizontal Line

Shows or hides the horizontal line associated to the active trace in a Cartesian diagram area. The horizontal line (or display line) can be moved to particular trace points in

order to retrieve the response values. It also shows which parts of a trace are above or below a definite response value.

**Access:** TRACE > Lines key or Alt + Shift + E



### Response Value

Defines/shows the response value of the horizontal line.

**Tip:** Use the R&S ZNC/ZND's drag-and-drop functionality to move the horizontal line to a particular position. The response value appears in the numeric entry field.

Remote command:

`CALCulate<Chn>:DLINe`

### Horizontal Line

Displays or hides the horizontal line.

Remote command:

`CALCulate<Chn>:DLINe:STATe`

## 4.2.6 Marker Settings

The marker settings are used to position markers on a trace and define their properties. Markers are also convenient tools for searching special points on traces and for scaling diagrams.



### Background information

Refer to the following sections:

- [Chapter 3.2.2.3, "Markers"](#), on page 29
- chapter "Set by Marker" in the Help or in the Getting Started guide

### 4.2.6.1 Marker > Markers

Creates markers and configures their properties. Markers are available for all diagram types (TRACE > FORMAT). A first marker labeled "M1" is automatically created when the MARKER key is pressed.

The "Mkr 1 ... Mkr 10" and "Ref Mkr" softkeys create markers or remove them from the display. A removed marker remembers its properties (stimulus value, format, delta mode, number) and will be restored with these properties when "Mkr <n>" or "Ref Mkr" is selected again. The marker properties are definitely lost when the associated trace is deleted.



### Related information

Refer to the following sections:

- [Chapter 3.2.2.3, "Markers"](#), on page 29
- See chapter "Operating the Instrument > Handling Diagrams, Traces, and Markers" in the Help system or in the R&S ZNC/ZND Getting Started guide.

**Access:** TRACE > MARKER key or Alt + Shift + G

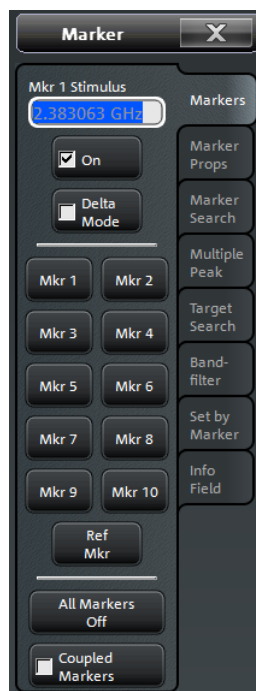

### Mkr Stimulus / On / Delta Mode

The functions on top of the softkey panel act on all markers; see "[Mkr 1 ... Mkr 10](#)" on page 211.

Remote command:

```
CALCulate<Chn>:MARKer<Mk>:X
CALCulate<Chn>:MARKer<Mk>[:STATe]
CALCulate<Chn>:MARKer<Mk>:REFerence:X
CALCulate<Chn>:MARKer<Mk>:REFerence[:STATe]
CALCulate<Chn>:MARKer<Mk>:DELTA[:STATe]
```

### Mkr 1 ... Mkr 10

Creates the markers numbered 1 to 10 and assigns them to the active trace. When a marker is created, a triangle labeled "M<n>" is positioned on the trace and the marker coordinates are displayed in the movable info field.

The stimulus position of an active marker can be entered in the "Mkr <n> Stimulus" entry field. The default position is the center of the sweep range. You can also simply drag and drop markers to change their x-axis position.

See also "[Activating and Moving Markers](#)" on page 29.

Remote command:

```
CALCulate<Chn>:MARKer<Mk>[:STATe]
CALCulate<Chn>:MARKer<Mk>:Y?
CALCulate<Chn>:MARKer[:STATe]:AREA
```

### Ref Mkr

Creates a reference marker and assigns it to the active trace. When a marker is created, a triangle labeled "R" is positioned on the trace and the marker coordinates are displayed in the info field.

The stimulus position of the active reference marker can be entered in the "Ref Marker Stimulus" entry field. The default position is the start of the sweep range or the position of the last active marker.

The reference marker defines the reference value for all markers that are in "Delta Mode".

Remote command:

```
CALCulate<Chn>:MARKer<Mk>:REFerence[:STATe]
CALCulate<Chn>:MARKer<Mk>:REFerence:Y?
```

### All Markers Off

Removes all markers from the active trace. Markers on other traces are not affected. The removed markers remember their properties (stimulus value, format, delta mode, number) when they are restored. The marker properties are definitely lost when the associated trace is deleted.

**Tip:** To delete a single marker, drag it into vertical direction to release it from the trace and drop it onto the "Delete" icon.

Remote command:

```
CALCulate<Chn>:MARKer<Mk>:AOFF
```

### Coupled Markers

Couples the markers of all traces in the active recall set to the markers of the active trace. While marker coupling is active, the active trace markers assume the role of master markers; the other markers behave as slave markers, following any change of position of the master marker. Coupled markers allow you to compare different measurement results (assigned to different traces) at the same stimulus value (i.e., at the same measurement point).

See also "[Marker Coupling](#)" on page 32.

Remote command:

```
CALCulate<Chn>:MARKer<Mk>:COUPled[:STATe]
```

#### 4.2.6.2 Marker > Marker Props

Modifies the properties of a marker created previously (see [Chapter 4.2.6.1, "Marker > Markers"](#), on page 210). The functions (except "Export Markers...") are unavailable if the active trace contains no markers.

**Access:** TRACE > MARKER key or Alt + Shift + G

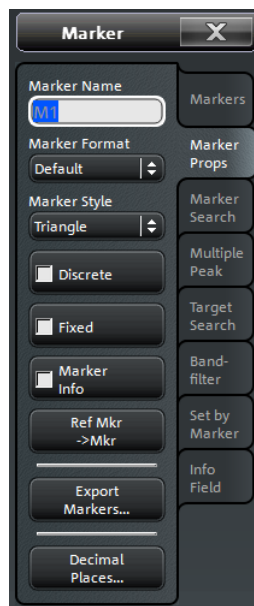

### Marker Name

Assigns a (new) name to the active marker. Marker names may exceed the length of the input box and contain letters, numbers, blanks and special characters.

Remote command:

```
CALCulate<Chn>:MARKer<Mk>:NAME
```

```
CALCulate<Chn>:MARKer<Mk>:REFerence:NAME
```

### Marker Format

Defines the formatting of the active marker in the movable marker info field.

Note that in contrast to previous releases "Default" now means the marker is formatted according the related trace's [Default Marker Frmt](#), which may not be set to "Default" (i.e. formatted according to the selected trace format).

For background information on marker formats see "[Marker Format](#)" on page 31.

Remote command:

```
CALCulate<Chn>:MARKer<Mk>:FORMat
```

### Marker Style

Defines how the selected marker is displayed on the screen.

Remote command:

n/a

### Discrete

Discrete mode means that a marker can be set to discrete sweep points only. If discrete mode is switched off, the marker can be positioned on any point of the trace, and its response values are obtained by interpolation.

Remote command:

```
CALCulate<Chn>:MARKer<Mk>:MODE
```

```
CALCulate<Chn>:MARKer<Mk>:REFerence:MODE
```

**Fixed**

Freezes the current response value of the selected marker. The marker can still be shifted horizontally but the vertical position remains fixed if the other marker settings are changed. Markers must be inside the sweep range and have a valid response value when they are fixed.

Remote command:

```
CALCulate<Chn>:MARKer<Mk>:TYPE
```

```
CALCulate<Chn>:MARKer<Mk>:REFerence:TYPE
```

**Marker Info**

Displays the marker coordinates above the marker symbol.

Remote command:

n/a

**Ref Mkr -> Mkr**

Places the reference marker to the position of the active marker. "Ref. Mkr -> Mkr" is not active if the active marker is a reference marker.

Remote command:

n/a

**Export Markers**

Calls up a "Save As"... dialog to store the current marker values to a marker file.

The analyzer uses a simple ASCII format to export marker values. By default, the marker file extension is \*.txt. The file contains all traces in the active recall set together with their names and measured quantities. Below each trace, the file shows a list of all markers with their names, stimulus and response values.

The following example of a marker file describes a recall set with two traces, "Trc1" and its memory trace "Mem2[Trc1]". "Trc1" has a reference marker "R" and three normal markers "M1, M2, M3" assigned, the memory trace has no markers.

```
Trc1 S21
R 869.01766 MHz -4.751 dB
M1 5.621400 GHz 1.351 dB
M2 3.380996 GHz -6.043 dB
M3 1.928122 GHz -4.700 dB

Mem2[Trc1] S21
No Markers
```

Remote command:

```
MMEMorY:STORe:MARKer
```

**Decimal Places**

Opens the "System Config" dialog to define the (maximum) number of fractional digits for setting values and measurement results. See also [Chapter 4.6.2.3, "User Interface"](#), on page 336.

**4.2.6.3 Marker > Marker Search**

The "Marker Search" functions use markers to locate specific points on the trace. The functions are unavailable if the active trace contains no markers (e.g. after "All Markers Off").

The marker search extends over a configurable range of stimulus values ("Search Range..."). In the default configuration, the search range is equal to the entire sweep range.



### Background information

Refer to "[Basic Marker Search Functions](#)" on page 33.

**Access:** TRACE > MARKER key or Alt + Shift + G

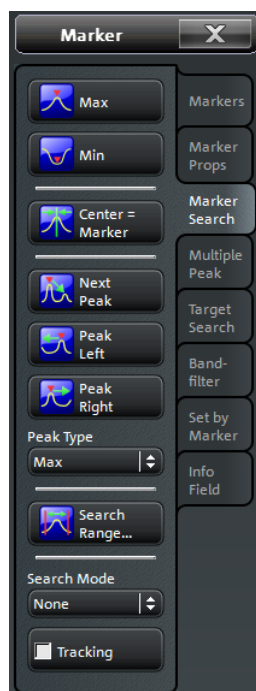

### Max / Min

Sets the active marker to the absolute maximum or minimum in the search range, i.e. to the largest or smallest of all response values. If a complex trace format (e.g. a polar diagram) is active, the marker is set to the measurement point with the maximum or minimum magnitude.

"Max" and "Min" also overwrite the current "Search Mode" (--> "Search Min" and "Search Max") and the "Peak Type" for the peak search functions.

Remote command:

```
CALCulate<Chn>:MARKer<Mk>:FUNction:EXECute MINimum | MAXimum  
CALCulate<Chn>:MARKer<Mk>:FUNction:RESult?
```

### Center = Marker

Sets the center of the sweep range equal to the stimulus value of the active marker, leaving the span unchanged. The active marker appears in the center of the diagram. This function is useful to focus on the sweep segment of particular interest, e.g. after a maximum or minimum search.

Remote command:

```
CALCulate<Chn>:MARKer<Mk>:FUNction:CENTer
```

**Next Peak / Peak Type**

Sets the active marker to the next maximum or minimum in the search range, depending on the "Peak Type" setting.

- If "Max" is active, then the marker is set to the next maximum. The next maximum is the maximum with the largest response value that is below the current marker response value.
- If "Min" is active, then the marker is set to the next minimum. The next minimum is the minimum with the smallest response value that is above the current marker response value.
- If "Min or Max" is active, then the marker is set to the next minimum or maximum, whichever has the smallest distance from the current marker response value.

Remote command:

```
CALCulate<Chn>:MARKer<Mk>:FUNCTION:EXECute NPEak
CALCulate<Chn>:MARKer<Mk>:FUNCTION:RESult?
```

**Peak Left / Right**

Sets the active marker to the next maximum or minimum to the left or right of the current marker position, depending on the "Peak Type" setting.

- If "Max" is active, then the marker is set to the next maximum.
- If "Min" is active, then the marker is set to the next minimum.
- If "Min or Max" is active, then the marker is set to the next minimum or maximum, whichever is closer.

Remote command:

```
CALCulate<Chn>:MARKer<Mk>:FUNCTION:EXECute LPEak | RPEak
CALCulate<Chn>:MARKer<Mk>:FUNCTION:RESult?
```

**Search Mode**

Indicates the current search mode, depending on the last executed search function.

Remote command:

```
CALCulate<Chn>:MARKer<Mk>:FUNCTION:EXECute?
```

**Tracking**

Enables/disables tracking of the active marker for "Marker Search" and "Target Search" modes, which causes the marker to be updated after each sweep.

Tracking for bandfilter search can be activated separately, see "[Tracking](#)" on page 225.

Among the "Marker Search" and "Target Search" modes, the tracking functionality only makes sense for

- "Marker Search: Min/Max", where such an update typically causes the marker to change both its horizontal and vertical position and
- "Target Search: Target Search", where typically only the horizontal position changes

Define an adequate "Search Range" to restrict the search to the adequate frequency or power interval (see [Chapter 4.2.6.4, "Search Range \(Dialog\)"](#), on page 217).

Remote command:

```
CALCulate<Chn>:MARKer<Mk>:SEARch:TRACking
```



#### 4.2.6.4 Search Range (Dialog)

The "Search Range" dialog confines the "Marker Search" and "Target Search" for the selected marker to a subrange of the sweep. The search range is a continuous interval of the sweep variable.

If [Tracking](#) is active, the assigned search range applies to all sweeps and can be used to achieve uniqueness in "Marker Search Min", "Marker Search Max" or "Target Search".

See also [Chapter 4.2.4.10, "Trace Config > Trace Statistics"](#), on page 181.

**Access:** TRACE > MARKER > Marker Search > Search Range...



It is possible to define up to ten different search ranges for each recall set and assign them to the markers no. 1 to 10.

##### Select Marker

Selects the reference marker or one of the ten numbered markers that can be assigned to the trace. If a numbered marker does not exist, it is created as soon as "On" is checked. A created marker is displayed in the center of the search range.

##### Search Range

Selects the search range to be assigned to the selected marker. "Full Span" means that the search range is equal to the sweep range. Besides, it is possible to store up to 10 customized search ranges.

The search ranges are bordered by the "Start" and "Stop" values. "Start" must be smaller than "Stop", otherwise the second value is automatically adjusted.

##### Search range properties

The ten search ranges are valid for the entire recall set. Each of them can be assigned to any marker in the recall set, irrespective of the trace and channel that the marker belongs to.

The default search range of any new marker is "Full Span". The analyzer provides the greatest flexibility in defining search ranges. In particular, two search ranges may overlap or even be identical. The search is confined to the part of the search range that belongs to the sweep range.

The following example shows how search ranges can be used to search a trace for several local maxima.

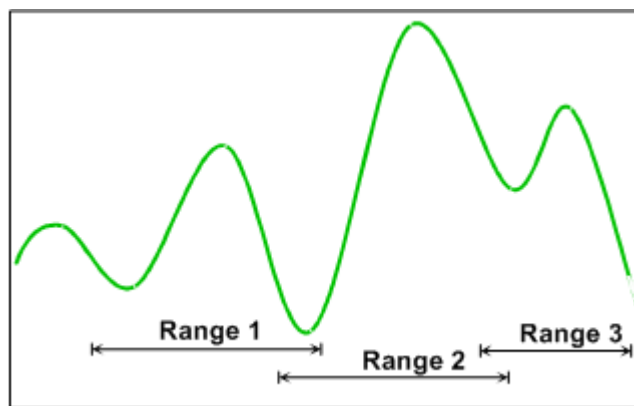

**Note:** The search ranges are identical to the evaluation ranges for trace statistics. For more information see [Chapter 4.2.4.11, "Evaluation Range \(Dialog\)"](#), on page 186.

Remote command:

```
CALCulate<Chn>:MARKer<Mk>:FUNction:DOMain:USER[:RANGe]
```

```
CALCulate<Chn>:MARKer<Mk>:FUNction:DOMain:USER:START
```

```
CALCulate<Chn>:MARKer<Mk>:FUNction:DOMain:USER:STOP
```

#### Range Limit Lines on

Displays or hides the range limit lines in the diagram area. Range limit lines are two vertical lines at the Start and Stop values of the active search range ("Range 1" to "Range 10").

Remote command:

```
CALCulate<Chn>:MARKer<Mk>:FUNction:DOMain:USER:SHOW
```

#### 4.2.6.5 Marker > Multiple Peak

Multiple peak search allows to find multiple local minima/maxima at once.



#### Background information

Refer to "[Basic Marker Search Functions](#)" on page 33.

---

**Access:** TRACE > MARKER key or Alt + Shift + G

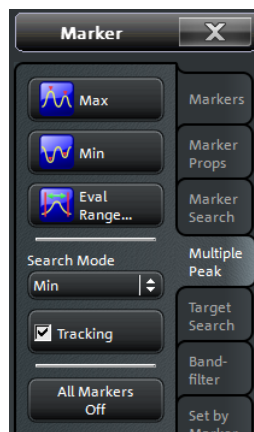

### Max / Min / Search Mode

Sets up to 10 markers to the highest maxima or lowest minima in the configured [Eval Range](#). If a complex trace format is active (e.g. a polar diagram), the markers are set to the measurement points with the maximum or minimum magnitude.

The required markers are created/deleted as needed.

Remote command:

```
CALCulate<Chn>:MARKer<Mk>:FUNction:EXECute MMAXimum | MMINimum
CALCulate<Chn>:MARKer<Mk>:FUNction:RESult?
```

### Eval Range

Opens the [Evaluation Range \(Dialog\)](#) that allows you to set the domain for the multiple peak search. A modified domain will take effect the next time [Max / Min / Search Mode](#) is used.

### Tracking

Enables or disables tracking for multiple peak search. If enabled a new multiple peak search is performed for each sweep (creating/deleting markers as needed).

Define an [Eval Range](#) to restrict the search to the adequate frequency or power interval.

Remote command:

```
CALCulate<Chn>:MARKer<Mk>:SEARch:TRACking
```

### All Markers Off

See "[All Markers Off](#)" on page 212.

#### 4.2.6.6 Marker > Target Search

The "Target Search" functions use markers to locate trace points with a specific response value ("Target Value"). The functions are unavailable if the active trace contains no markers (e.g. after "All Markers Off").

**Access:** TRACE > MARKER key or Alt + Shift + G

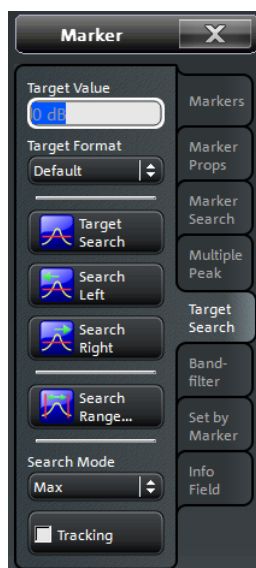

Some of the "Target Search" functions are equal to the corresponding "Marker Search" functions. Refer to the following sections:

- [Chapter 4.2.6.4, "Search Range \(Dialog\)"](#), on page 217
- ["Search Mode"](#) on page 216
- ["Tracking"](#) on page 216

### Target Value

Specifies the target value for the search.

Since V1.80 of the VNA software the target value can be specified in different formats (see [Target Format](#) below). For instance, this enables searching for particular phase values in Smith charts.

Remote command:

`CALCulate<Chn>:MARKer<Mk>:TARGet`

### Target Format

Selects the format in which the [Target Value](#) shall be specified.

The selected target format applies to the current marker only: each marker may have a different target format. The table below gives an overview on how a complex target value  $z = x + jy$  is converted.

Target Format	Description	Formula
Lin Mag	Magnitude of $z$ , unconverted.	$ z  = \sqrt{x^2 + y^2}$
dB Mag [dB]	Magnitude of $z$ in dB	$\text{Mag}(z) = 20 \log z  \text{ dB}$
Phase [°]	Phase of $z$	$\varphi(z) = \arctan(y/x)$
Phase unwrap [°]	Unwrapped phase of $z$ comprising the complete number of 360° phase rotations	$\Phi(z) = \varphi(z) + 2k \cdot 360^\circ$
Real	Real part of $z$	$\text{Re}(z) = x$

Target Format	Description	Formula
Imag	Imaginary part of z	$\text{Im}(z) = y$
SWR	(Voltage) Standing Wave Ratio	$\text{SWR} = (1 +  z ) / (1 -  z )$
Default	Identical to trace format. <b>Note:</b> the Smith and Polar traces use "Lin Mag" as the default format for target value.	-

Remote command:

```
CALCulate<Chn>:MARKer<Mk>:SEARch:FORMat
```

### Target Search

Activates the search and sets the active marker to the defined target value. If the target value occurs at several stimulus values, the marker is placed to the search result with the smallest stimulus value. The other measurement points with the same target value can be located using the "Search Right" function.

If the target is not found (e.g. because the active trace doesn't contain the target value), then the active marker is not moved away from its original position.

Remote command:

```
CALCulate<Chn>:MARKer<Mk>:FUNctIon:EXECute TARGet  
CALCulate<Chn>:MARKer<Mk>:FUNctIon:RESult?
```

### Search Left

Activates the search to the left of the active marker position and sets the active marker to the defined target value. The target search range is between the "Start" value of the search range and the active marker position.

If the target value occurs at several stimulus values, the marker is placed to the search result with the largest stimulus value (i.e. the one which is closest to the active marker position). The other measurement points with the same target value can be located using "Search Left" repeatedly.

If the target is not found (e.g. because the active trace doesn't contain the target value), then the active marker is not moved away from its original position.

Remote command:

```
CALCulate<Chn>:MARKer<Mk>:FUNctIon:EXECute LTAGet  
CALCulate<Chn>:MARKer<Mk>:FUNctIon:RESult?
```

### Search Right

Activates the search to the right of the active marker position and sets the active marker to the defined target value. The target search range is between the active marker position and the "Stop" value of the search range.

If the target value occurs at several stimulus values, the marker is placed to the search result with the smallest stimulus value (i.e. the one which is closest to the active marker position). The other measurement points with the same target value can be located using "Search Right" repeatedly.

If the target is not found (e.g. because the active trace doesn't contain the target value), then the active marker is not moved away from its original position.

Remote command:

```
CALCulate<Chn>:MARKer<Mk>:FUNction:EXECute RTARget
CALCulate<Chn>:MARKer<Mk>:FUNction:RESult?
```

#### 4.2.6.7 Marker > Bandfilter Search

The "Bandfilter Search" functions search for trace segments with a bandpass or band-stop shape and determine characteristic filter parameters.



#### Background information

Refer to "Bandfilter Search" on page 34.

#### "Bandfilter Search" for arbitrary scalar traces

Bandfilter search can be used for a broad range of measured quantities (TRACE > MEAS). To obtain real filter parameters, the display format must be dB Mag, the measured quantity must be a transmission S-parameter and a frequency sweep must be performed. However, for other formats, measured quantities or sweep types, the "Bandfilter Search" functions may still be useful to analyze general trace properties.

**Access:** TRACE > MARKER key or Alt + Shift + G

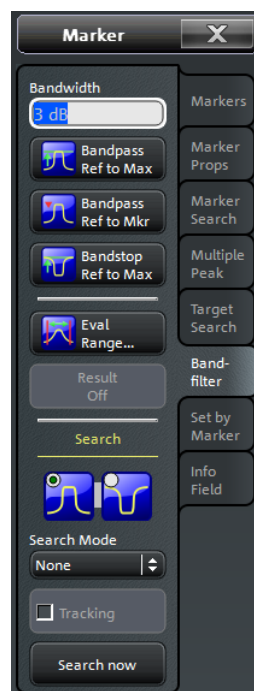

Many of the "Bandfilter Search" functions are equal to the corresponding "Marker Search" functions. Refer to the following sections:

- [Chapter 4.2.6.4, "Search Range \(Dialog\)", on page 217](#)
- ["Search Mode" on page 216](#)
- ["Tracking" on page 216](#)

### Bandwidth

Specifies the minimum excursion of the bandpass and bandstop peaks.

- A bandpass peak must fall off on both sides by the specified <Bandwidth> value to be considered a valid peak.
- A bandstop peak must be <Bandwidth> below the maximum level in the search range (bandpass value) to be considered a valid peak.

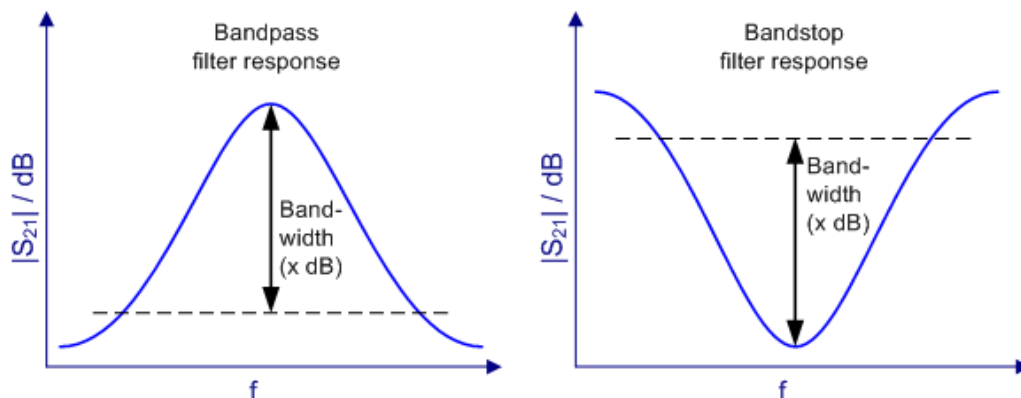

Remote command:

`CALCulate<Chn>:MARKer<Mk>:TARGet`

### Bandpass Ref to Max

Activates the search for a bandpass region on the active trace and activates bandfilter "Tracking". The located bandpass region is the tallest peak in the search range with with a minimum excursion as specified by the "Bandwidth" parameter.

If "Bandpass Ref to Max" is selected the analyzer uses (or creates) the four markers "M1" to "M4" to locate the **bandpass region**.

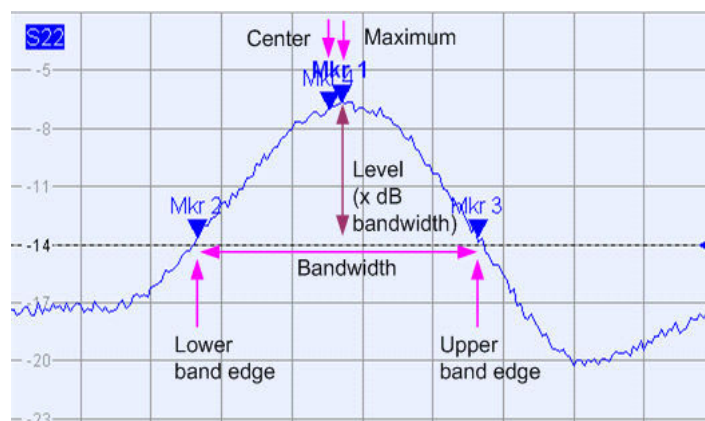

- "M1" indicates the maximum of the peak ("Max").
- "M2" indicates the point on the left edge of the peak where the trace value is equal to the maximum minus the bandwidth factor ("Lower Edge").
- "M3" indicates the point on the right edge of the peak where the trace value is equal to the maximum minus the bandwidth factor ("Upper Edge").
- "M4" indicates the center of the peak. Depending on a system setting the center is either calculated as the geometric or the arithmetic mean of the "Lower Edge" and

"Upper Edge" frequencies (see ["Geometric Calculation of Bandfilter Center"](#) on page 339).

The bandfilter search results are displayed in the movable bandfilter info field.

Remote command:

```
CALCulate<Chn>:MARKer<Mk>:FUNction:BWIDth:MODE BPASs
CALCulate<Chn>:MARKer<Mk>:FUNction:EXECute BFILter
CALCulate<Chn>:MARKer:SEARch:BFILter:RESult[:STATe]:AREA
```

### Bandpass Ref to Mkr

Activates the search for a bandpass region on the active trace and activates bandfilter "Tracking", starting at the position of the active marker. A bandpass region is the closest peak in the search range with a minimum excursion as specified by the "Bandwidth" parameter.

In contrast to a "Bandpass Ref to Max", the "Bandpass Ref to Mkr" does not change the position of the active markers. The bandfilter search results are displayed in the movable bandfilter info field.

Remote command:

```
CALCulate<Chn>:MARKer<Mk>:FUNction:BWIDth:MODE BPRMarker
CALCulate<Chn>:MARKer<Mk>:FUNction:EXECute BFILter
```

### Bandstop Ref to Max

Activates the search for a bandstop region on the active trace and activates bandfilter "Tracking". A bandstop region is the lowest peak (local minimum) in the search range, provided that its level is at least <Bandwidth> below the maximum (passband value).

If "Bandstop Ref to Max" is selected the analyzer uses (or creates) the four markers "M1" to "M4" to locate the **bandstop region**.

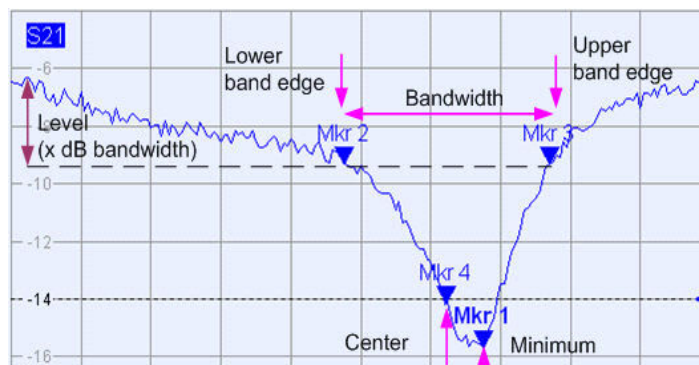

- "M1" indicates the minimum of the peak ("Min").
- "M2" indicates the point on the left edge of the peak where the trace value is equal to the maximum in the search range (passband value) minus the bandwidth factor ("Lower Edge").
- "M3" indicates the point on the right edge of the peak where the trace value is equal to the maximum in the search range (passband value) minus "Bandwidth" x (Upper Edge).
- "M4" indicates the center of the peak. Depending on a system setting the center is either calculated as the geometric or the arithmetic mean of the "Lower Edge" and



"Upper Edge" positions (see ["Geometric Calculation of Bandfilter Center"](#) on page 339).

The bandfilter search results are displayed in the movable bandfilter info field.

Remote command:

```
CALCulate<Chn>:MARKer<Mk>:FUNction:BWIDth:MODE BStOp
CALCulate<Chn>:MARKer<Mk>:FUNction:EXECute BFILter
```

### Result Off

Hides the movable info field with the results of a bandpass or a bandstop search and disables bandfilter "Tracking". The info field is displayed again (and tracking re-enabled) when a new bandfilter search is performed.

Remote command:

```
CALCulate<Chn>:MARKer<Mk>:BWIDth
CALCulate<Chn>:MARKer:SEARch:BFILter:RESult[:STATe]
```

### Search / Search Mode

Enables a bandpass or bandstop search (left/right icon) for an arbitrary search mode. The search modes have the following effect:

- "Bandpass/Bandstop Ref to Max": The bandpass/bandstop is the tallest/lowest peak in the search range. For a detailed description refer to ["Bandpass Ref to Max"](#) on page 223 and ["Bandstop Ref to Max"](#) on page 224.
- "Bandpass/Bandstop Ref to Marker": The bandpass/bandstop is the tallest/lowest peak in the search range. The response value for the lower and upper band edges is calculated as the response value at the active marker position plus/minus x, where x is equal to the <Bandwidth> value. To be valid the peak must be above/below the response value for the band edges.
- "Bandpass/Bandstop Absolute Level:" The bandpass/bandstop is the tallest/lowest peak in the search range. To be valid, the peak must be above/below  $-x$ , where x is numerically equal to the <Bandwidth> value. The Lower Band Edge and Upper Band Edge values are given by the frequencies where the trace is equal to  $-x$ .
- "None": Bandfilter search switched off, result off.

Remote command:

```
CALCulate<Chn>:MARKer<Mk>:FUNction:BWIDth:MODE
CALCulate<Chn>:MARKer<Mk>:BWIDth
CALCulate<Chn>:MARKer:SEARch:BFILter:RESult[:STATe]
```

### Tracking

Causes the active bandfilter search to be repeated after each sweep: When tracking mode is active the markers typically change their horizontal and vertical positions as the measurement proceeds.

### Tracking mode properties

Tracking modes are available for all search modes. The tracking modes for minimum/maximum/peak search and target search are coupled; tracking for bandfilter search can be activated separately. Bandfilter tracking is activated automatically when one of the bandfilter search modes is selected.

Remote command:

Bandfilter tracking and marker/target search tracking are controlled with the same command:

`CALCulate<Chn>:MARKer<Mk>:SEARCh:TRACking`

#### 4.2.6.8 Marker > Set by Marker

The "Set by Marker" functions use the active marker to define the sweep range, scale the diagram and introduce an electrical length offset. The functions are unavailable if the active trace contains no markers (e.g. after "All Markers Off").



#### Examples

Refer to chapter "Set by Marker" in the Help or in the Getting Started guide.

**Access:** TRACE > MARKER key or Alt + Shift + G

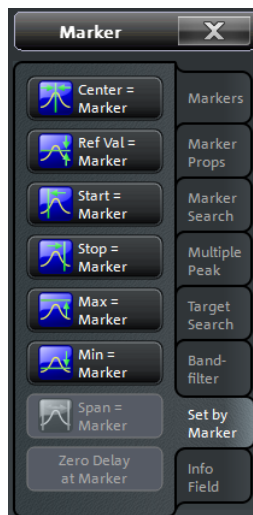

#### Center / Start / Stop / Span = Marker

The following functions use the stimulus value of the active marker to define the sweep range.

- **Center = Marker** sets the center of the sweep range equal to the stimulus value of the active marker, leaving the span unchanged. The active marker appears in the center of the diagram.
- **Start = Marker** sets the beginning (start) of the sweep range equal to the stimulus value of the active marker, leaving the end (stop) value unchanged. The active marker appears at the left edge of the diagram.
- **Stop = Marker** sets the end (stop) of the sweep range equal to the stimulus value of the active marker, leaving the beginning (start) unchanged. The active marker appears at the right edge of the diagram.
- **Span = Marker** sets the span of the sweep range equal to the absolute value of the first coordinate of the active delta marker, i.e. to the difference between the delta marker and the reference marker positions. The function is available only if the active marker is in "Delta Mode". The reference marker appears at the right, the

delta marker at the left edge of the diagram or vice versa, depending on which of the two markers has the smaller stimulus value.

Remote command:

```
CALCulate<Chn>:MARKer<Mk>:FUNction:CENTer
CALCulate<Chn>:MARKer<Mk>:FUNction:START
CALCulate<Chn>:MARKer<Mk>:FUNction:STOP
CALCulate<Chn>:MARKer<Mk>:FUNction:SPAN
```

#### Ref Val / Max / Min = Marker

The following functions use the response value of the active marker to scale the y-axis of the diagram:

- **Ref Val = Marker** sets the reference value equal to the response value of the active marker, leaving the values of the vertical divisions ("Scale / Div") unchanged.
- **Max = Marker** sets the upper edge of the diagram equal to the response value of the active marker, leaving the values of the vertical divisions ("Scale / Div") unchanged.
- **Min = Marker** sets the lower edge of the diagram equal to the response value of the active marker, leaving the values of the vertical divisions ("Scale / Div") unchanged.

Remote command:

n/a

#### Zero Delay at Marker

Corrects the measurement result by adding or subtracting a constant group delay. This function must be applied to a trace which is displayed in group delay format. The trace is shifted in vertical direction so that the delay at the marker position vanishes.

The delay represents the propagation time of the wave across the DUT, so this operation corresponds to a electrical length compensation, i.e. to a shift of the reference plane by adding to or subtracting from the test port a simulated lossless transmission line of variable length. The correction must be carried out on the "Delay" trace but has an impact on all trace formats.

A standard application of "Zero Delay at Marker" is correction of the constant delay caused by the interconnecting cables between the analyzer test ports and the DUT (line stretch).

**Note:** "Zero Delay at Marker" modifies the "Offset" parameters and therefore influences the entire channel.

Remote command:

n/a

#### 4.2.6.9 Marker > Info Field

Displays or hides the marker info field and selects its contents. The functions are self-explanatory.



#### Background information

Refer to "[Marker Info Field](#)" on page 30

**Access:** TRACE > MARKER key or Alt + Shift + G

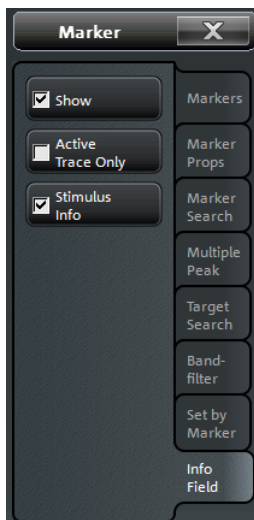

## 4.3 Stimulus Settings

The "Channel > Stimulus" settings define the sweep range in the current channel, depending on the sweep type.

In Cartesian diagrams, the sweep range corresponds to the diagram width and defines the scaling of the x-axis. In polar diagrams and Smith charts the stimulus axis is lost but the marker functions easily provide the stimulus value of any measurement point.



All stimulus settings except the "Time Domain X-Axis" settings are channel settings. "Time Domain X-Axis" applies to the active trace which must be transformed into time domain.

---



### Background information

Refer to the following sections:

- [Chapter 3.1.3, "Traces, Channels and Diagrams"](#), on page 12
  - chapter "Setting the Sweep Range" in the Help or in the Getting Started guide
  - chapter "Using Marker Functions" in the Help or in the Getting Started guide
- 

### 4.3.1 Stimulus > Stimulus

Defines the sweep range in the current channel, depending on the sweep type.



### Related Settings

Refer to the following sections:

- [Chapter 3.1.4.3, "Stimulus and Sweep Types"](#), on page 17
- [Chapter 4.4.2.2, "Sweep > Sweep Type"](#), on page 239

**Access:** STIMULUS keys or Alt + Shift + J

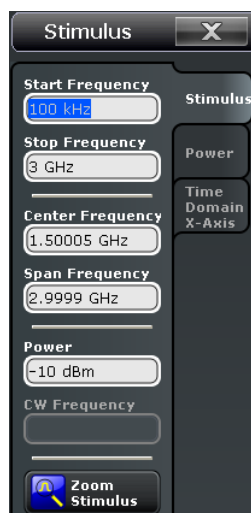

### Start / Stop / Center / Span Frequency (Power / Time)

Defines the sweep range:

- "Start ..." is the lowest value of the sweep variable (e.g. the lowest frequency measured) and corresponds to the left edge of the Cartesian diagram.
- "Stop ..." is the highest value of the sweep variable (e.g. the highest frequency measured) and corresponds to the right edge of the Cartesian diagram.
- "Center..." corresponds to the center of the Cartesian diagram, i.e.  $(\text{Start ...} + \text{Stop ...})/2$ .
- "... Span" corresponds to the diagram width, i.e.  $(\text{Stop ...} - \text{Start ...})$ .

For a frequency sweep the "Start Frequency" and "Stop Frequency" or the "Center Frequency" and "Frequency Span" are alternative settings.

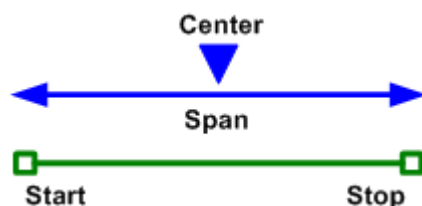

For the other sweep types, some of the input fields are unavailable; see [Table 3-1](#).

Remote command:

```
[SENSe<Ch>:] FREQuency: START
[SENSe<Ch>:] FREQuency: STOP
[SENSe<Ch>:] FREQuency: CENTER
[SENSe<Ch>:] FREQuency: SPAN
```

```

SOURce<Ch>:POWer<PhyPt>:START
SOURce<Ch>:POWer<PhyPt>:STOP
[SENSe<Ch>:]SWEep:TIME
[SENSe<Ch>:]SWEep:POINTs
SYSTem:FREQuency? (query frequency range of the network analyzer)

```

### Power

Determines the output power at the test ports for the sweep types "Power", "CW Mode", and "Time". The setting has no effect for "Power" sweeps, where the source power is varied over a continuous range.

Remote command:

```
SOURce<Ch>:POWer<PhyPt>[:LEVel][:IMMediate][:AMPLitude]
```

### CW Frequency

Sets the fixed frequency for the sweep types "Power", "CW Mode", and "Time".

Remote command:

```

[SENSe<Ch>:]FREQuency:FIXed
[SENSe<Ch>:]FREQuency[:CW]
SOURce<Ch>:FREQuency<PhyPt>:FIXed
SOURce<Ch>:FREQuency<PhyPt>[:CW]

```

### Zoom Stimulus

Magnifies a rectangular portion of the diagram (zoom window) to fill the entire diagram area. See also [Chapter 4.2.3.3, "Scale > Zoom"](#), on page 161 or chapter "Operating the Instrument > Using the Graphic Zoom" in the Help system or in the R&S ZNC/ZND Getting Started guide.

Remote command:

```

DISPlay[:WINDow<Wnd>]:TRACe<WndTr>:ZOOM:BOTTom
DISPlay[:WINDow<Wnd>]:TRACe<WndTr>:ZOOM:START
DISPlay[:WINDow<Wnd>]:TRACe<WndTr>:ZOOM:STOP
DISPlay[:WINDow<Wnd>]:TRACe<WndTr>:ZOOM:TOP
DISPlay[:WINDow<Wnd>]:TRACe<WndTr>:ZOOM[:STATe]

```

## 4.3.2 Stimulus > Power

Defines the power of the internal signal source in the current channel, depending on the sweep type.

**Access:** STIMULUS keys or Alt + Shift + J



Most of the "Power" settings are also available in the "Stimulus" tab. Refer to the following sections:

- ["Power"](#) on page 230
- ["Start / Stop / Center / Span Frequency \(Power / Time\)"](#) on page 229

#### RF Off All Channels

"RF Off" switches the internal power source for all channels off (if checked) or on. Switching off the RF power helps to prevent overheating of a connected DUT while no measurement results are taken.

Remote command:

`OUTPut<Ch>[:STATe]`

### 4.3.3 Stimulus > Time Domain X-Axis

If the active trace is a time domain trace (enabled via "TRACE CONFIG > Time Domain"), these settings define its stimulus axis.



#### Related information

Refer to the following sections:

- [Chapter 3.7.5, "Time Domain Analysis"](#), on page 110
- [Chapter 4.2.4.7, "Trace Config > Time Domain"](#), on page 175

**Access:** STIMULUS keys or Alt + Shift + J



Figure 4-3: Stimulus > Time Domain X-Axis softtool tab

left = Time axis  
right = Distance axis

### Time Start / Stop / Center / Span

Defines the display range for the time domain trace.

- "Time Start" is the lowest displayed time and corresponds to the left edge of the Cartesian diagram.
- "Time Stop" is the highest displayed time and corresponds to the right edge of the Cartesian diagram.
- "Time Center" corresponds to the center of the Cartesian diagram, i.e.  $(\text{Time Start} + \text{Time Stop})/2$ .
- "Time Span" corresponds to the diagram width, i.e.  $(\text{Time Stop} - \text{Time Start})$ .

"Time Start" and "Time Stop" or "Time Center" and "Time Span" are alternative settings.

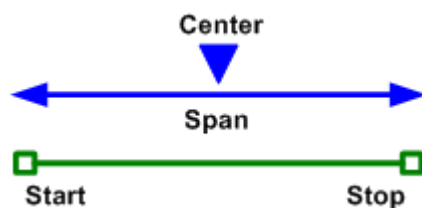

Remote command:

```
CALCulate<Chn>:TRANSform:TIME:START
CALCulate<Chn>:TRANSform:TIME:STOP
CALCulate<Chn>:TRANSform:TIME:CENTer
CALCulate<Chn>:TRANSform:TIME:SPAN
```

### Time / Distance

"Time" and "Distance" switch over between the x-axis scaling in time units or distance units.

The interpretation of time and distance depends on the measurement type. For reflection measurements, the time axis represents the propagation time of a signal from the source to the DUT and back. For transmission measurement, it represents the propagation time from the source through the device to the receiver.



The distance calculation is consistent with this picture:

- For reflection measurements (S-parameters  $S_{ii}$  or ratios with equal port indices) the distance between the source and the DUT is half the propagation time multiplied by the velocity of light in the vacuum times the velocity factor of the receiving port defined via "OFFSET EMBED > Offset" ( $Distance = 1/2 * \langle Time \rangle * c_0 * \langle Velocity Factor \rangle$ ). The factor 1/2 accounts for the return trip from the DUT to the receiver.
- For transmission measurements, the distance is calculated as the propagation time times the velocity of light in the vacuum times the velocity factor of the receiving port defined via "OFFSET EMBED > Offset" ( $Distance = \langle Time \rangle * c_0 * \langle Velocity Factor \rangle$ ).

Remote command:

`CALCulate<Chn>:TRANSform:TIME:XAXis`

## 4.4 Channel Settings

The "Channel" menu provides all channel settings and activates, modifies and stores different channels.



### Background information

Refer to the following sections:

- [Chapter 3.1.3, "Traces, Channels and Diagrams"](#), on page 12
- [Chapter 3.1.3.2, "Channel Settings"](#), on page 13
- [Chapter 3.1.4, "Sweep Control"](#), on page 14

### 4.4.1 Power Bandwidth Average Settings

The "Power Bw Avg" menu defines the power of the internal signal source(s), sets the step attenuators and the IF bandwidths, and configures the sweep average.

#### 4.4.1.1 Power Bw Avg > Power

Defines the power of the internal signal source(s). The settings are identical with the "Stimulus > Power" settings; see [Chapter 4.3.2, "Stimulus > Power"](#), on page 230.

#### 4.4.1.2 Power Bw Avg > Bandwidth

Sets the measurement bandwidth of the IF filter. The settings apply to all filters in the active channel. A system error correction (calibration) remains valid when the filter settings are changed.



### Optimizing the filter settings

A small filter bandwidth suppresses the noise level around the measurement frequency and thus increases the dynamic range. On the other hand the time needed to acquire a single measurement point increases with smaller filter bandwidths. For small bandwidths, the filter settling time, which is inversely proportional to the bandwidth, is responsible for the predominant part of the measurement time.



### Segmented sweeps

In "Segmented Frequency" sweeps, the filter settings can be selected independently for each segment. see [Chapter 4.4.2.3, "Define Segments \(Dialog\)"](#), on page 244.

**Access:** CHANNEL > POWER BW AVG key or Alt + Shift + L



left = R&S ZNC  
right = R&S ZND

### Bandwidth

Sets the measurement bandwidth of the IF filter. Within the value range, the entered value is rounded up to  $1.5 \cdot 10^n$  Hz,  $2 \cdot 10^n$  Hz,  $3 \cdot 10^n$  Hz,  $5 \cdot 10^n$  Hz,  $7 \cdot 10^n$  Hz,  $10 \cdot 10^n$  Hz. Values exceeding the maximum bandwidth are rounded down.

For the R&S ZNC the bandwidth range is 1 Hz to 300 kHz. For the R&S ZND it is 1 Hz to 70 kHz.

Remote command:

```
[SENSe<Ch>:]BANDwidth[:RESolution]
[SENSe<Ch>:]BWIDth[:RESolution]
```

#### 4.4.1.3 Power Bw Avg > Average

Defines the number of consecutive sweeps to be averaged and enables/disables the sweep average.



### Effects of sweep average, alternative settings

An average over several sweeps reduces the influence of random effects in the measurement and therefore minimizes the noise level. The effect increases with the average factor, however, obtaining an averaged result requires several sweeps and therefore increases the measurement time.

Smoothing is an alternative method of compensating for random effects on the trace by averaging adjacent measurement points. Compared to the sweep average, smoothing does not significantly increase the measurement time but can eliminate narrow peaks and thus produce misleading results.

The sweep average is not frequency selective. To eliminate a spurious signal in the vicinity of the measurement frequency from the trace, alternative techniques (e.g. a smaller filter bandwidth) must be used.



In contrast to the sweep count (for single sweep mode), averaging is always channel-specific. Both features are completely independent from each other.

The average factor is also valid for calibration sweeps: The calculation of system correction data is based on the averaged trace.

**Access:** CHANNEL > POWER BW AVG key or Alt + Shift + L

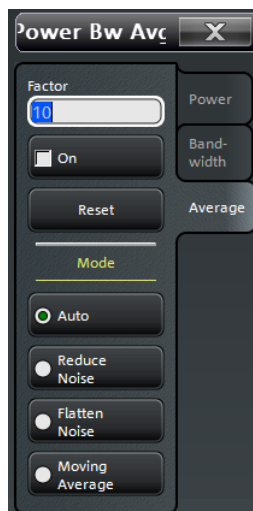

### Factor / On / Reset

"Factor" defines the number of averaged traces, "On" enables or disables the sweep average, "Reset" starts a new average cycle. The average cycle is also re-started when the "Mode" is changed.

Remote command:

```
[SENSe<Ch>:] AVERAge: COUNT
[SENSe<Ch>:] AVERAge [ : STATE]
[SENSe<Ch>:] AVERAge: CLEAR
```

### Mode

Selects one of the following averaging algorithms:

- **Auto:** Automatic selection between **Reduce Noise** and **Flatten Noise** mode, depending on the trace format.
- **Reduce Noise:** Cumulative moving averages of the real and imaginary parts of each measurement result, provides the most effective noise suppression for the "Real" and "Imag" formats and for polar diagrams.
- **Flatten Noise:** Cumulative moving averages of the (linear) magnitude and phase values, provides the most effective noise suppression for the "dB Mag", "Phase", "Unwr. Phase", and "Lin Mag" formats.
- **Moving Average:** Simple moving averages of the real and imaginary parts of each measurement result; similar to **Reduce Noise**, but with finite history.

Changing the mode resets the average cycle.

Remote command:

[SENSe<Ch>: ]AVERage:MODE on page 582

## 4.4.2 Sweep Settings

The "Sweep" menu defines the scope of the measurement in the active channel. This includes the sweep type with various parameters, the trigger conditions and the periodicity of the measurement.



### Background information

Refer to the following sections:

- [Chapter 3.1.4, "Sweep Control"](#), on page 14
- [Chapter 3.1.4.3, "Stimulus and Sweep Types"](#), on page 17

---

### 4.4.2.1 Sweep > Sweep Params

Controls the scope and timing of the measurement in the active channel.



### Segmented sweeps

In "Segmented Frequency" sweeps, the sweep parameters can be set independently for each segment. see [Chapter 4.4.2.3, "Define Segments \(Dialog\)"](#), on page 244.



### System error correction

In general, the system error correction is no longer valid after a change of the sweep parameters. The status of the calibration is shown in the trace list. If the number of points is changed, the analyzer interpolates the correction data. The calibration label "Cal Int" is displayed. See also [Chapter 3.5.4, "Calibration Labels"](#), on page 91.

---

**Access:** CHANNEL > SWEEP key or Alt + Shift + M



### Number of Points

Sets the total number of measurement points per sweep. The minimum number of points is 1 (measurement at a single frequency/power/time value). The maximum depends on the analyzer type.

Together with the sweep range defined with the "Stimulus" settings, this parameter defines the grid of sweep points. The sweep points are equidistantly distributed over the entire sweep range: The step width between two consecutive sweep points is constant on a linear scale (sweep types "Lin. Frequency", "Time" and "CW Mode") or on a logarithmic scale (sweep types "Log. Frequency" and "Power").

The sweep points for "Lin Frequency" sweeps may alternatively be defined using the "Frequency Step Size".

#### Tip: Measurement time and screen resolution

A large number of points improve the resolution of the trace but increases the measurement time. The overall measurement time is composed of the hardware settling time at the beginning of the sweep plus the sum of the measurement times at each individual sweep point. This implies that the measurement time increases roughly linearly with the number of points.

See also [Chapter 3.1.4, "Sweep Control"](#), on page 14.

Remote command:

```
[SENSe<Ch>:] SWEEp: POINts
```

### Freq Step Size

Sets the distance between two consecutive frequency sweep points.

The step size is an alternative to the "Number of Points" setting:

- If the sweep range is defined by means of the "Start" and "Stop" variables, both the "Stop" value and the "Number of Points" can vary as the "Freq Step Size" is changed. The "Stop" value is changed as little as possible so that the condition "Freq Step Size" = "(Stop – Start) / (Number of Points – 1)" can be fulfilled. Changing the Start and Stop values modifies the "Freq Step Size".
- If the sweep range is defined by means of the "Center" and "Span" variables, both the "Span" value and the "Number of Points" can vary as the "Freq Step Size" is changed. The "Span" is reduced as little as possible so that the condition "Freq

Step Size" = "(Stop – Start) / (Number of Points – 1)" can be fulfilled. Changing the "Span" modifies the "Freq Step Size".

**Note:** This setting is valid for linear frequency sweeps only. It does not apply to logarithmic and segmented sweeps, power, time or CW Mode sweeps. Increasing the "Freq Step Size" generally increases the measurement time.

Remote command:

```
[SENSe<Ch>:] SWEEp:STEP
```

### Sweep Time / Auto

Varies the measurement time for a sweep or delays the start of each sweep.

- "Sweep Time" is the total measurement time for the sweep. The minimum possible sweep time is equal to the estimated value in "Auto" mode. Setting a larger sweep time is equivalent to defining a [Meas Delay](#) before each partial measurement.
- "Auto" minimizes the sweep time. The "Meas. Delay" is set to 0 s. "Sweep Time" indicates the estimated sweep time, depending on the current measurement settings. The "Sweep Time" and "Meas. Delay" values are maintained until changed explicitly if "Auto" is switched off.

If a time sweep is active, "Sweep Time" is not available. The analyzer uses the previously defined sweep time settings.

Remote command:

```
[SENSe<Ch>:] SWEEp:TIME
```

```
[SENSe<Ch>:] SWEEp:TIME:AUTO
```

### Meas Delay

Adds a delay time before the start of the partial measurements. See [Chapter 3.1.4.1, "Partial Measurements and Driving Mode"](#), on page 15.

"Meas Delay" is not available while a time sweep or CW mode sweep is active. However, the analyzer takes into account a previously defined measurement delay.

As an alternative to increasing the delay (and thus the total sweep time), it is possible to select "Alternated" sweep; see ["Driving Mode"](#) on page 300.

Remote command:

```
[SENSe<Ch>:] SWEEp:DWELL
```

### All Partial Meas'ments / First Partial Meas'ment

If [Meas Delay](#) is set to a value > 0, this setting allows to define how the measurement delay is applied:

- If "All Partial Meas'ments" is selected, the delay time is added before each partial measurement. For a complete 2 port S-parameter measurement, the delay must be added twice per sweep point.
- If "First Partial Meas'ment" is selected, the delay time is added once per sweep point only, irrespective of the measured quantities and the number of partial measurements. The sweep time increases by the measurement delay times the number of sweep points.

**Tip:** A delay time before the start of each partial measurement increases the accuracy, in particular for measurements on DUTs with long settling times (e.g. quartz oscillators, SAW filters). Select "First Partial Meas'ment" if the DUT does not require an additional settling time due to the interchange of source and receive ports.

Remote command:

[SENSe<Ch>:] SWEEp:DWELl:IPoint

#### 4.4.2.2 Sweep > Sweep Type

Defines the sweep variable (frequency/power/time) and the position of the sweep points across the sweep range.

**Access:** CHANNEL > SWEEP key or Alt + Shift + M



#### Lin Freq

In a "Lin Freq" sweep the stimulus frequency is swept in equidistant steps over the continuous frequency range. The frequency range (sweep range) is defined with the STIMULUS settings. The step width between two consecutive sweep points is constant and given by  $\frac{\text{Span}}{(n - 1)}$  where  $n$  is the specified "Number of Points" ( $n > 1$ ). The internal generator power can be set via "POWER BW AVG > Power".

"Lin Freq" is the default sweep type. In a Cartesian diagram the measurement result is displayed as a trace over a linear frequency scale (as known e.g. from spectrum analyzers). The following example shows a "Lin Freq" sweep with a stimulus range between 4 GHz and 6 GHz, the forward transmission parameter  $S_{21}$  as measured quantity, and a "dB Mag" scaled y-axis.

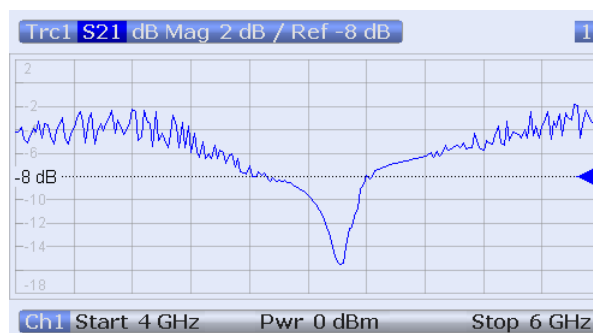

Remote command:

[SENSe<Ch>:] SWEEp:TYPE LINear

### Log Freq

In a "Log Freq" sweep the stimulus frequency is swept on a logarithmic scale over the continuous frequency range. The frequency range (sweep range) is defined with the STIMULUS settings. The sweep points are calculated from the "Span" and the specified "Number of Points" ( $n > 1$ ) with the condition that the step width is constant on the logarithmic scale. The internal generator power can be set via "POWER BW AVG > Power".

"Log Freq" sweeps are suitable for the analysis of a DUT over a large frequency range, e.g. over several octaves. In a Cartesian diagram the measurement result is displayed as a trace over a logarithmic frequency scale. The following example shows a "Log Freq" sweep with a stimulus range between 1 MHz and 6 GHz, the forward transmission parameter  $S_{21}$  as measured quantity, and a "dB Mag" scaled y-axis.

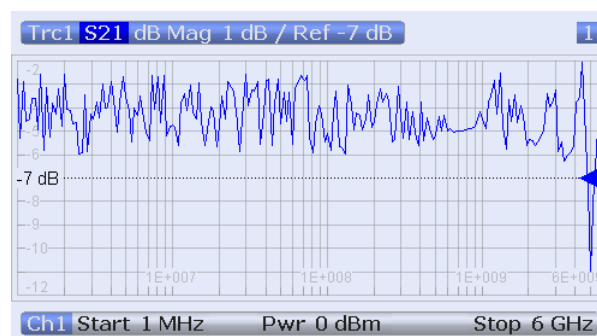

**Tip:** In "Log Freq" representation, limit lines and ripple limit lines appear as exponential curves; see [Chapter 3.4.1.1, "Rules for Limit Line Definition"](#), on page 64.

Remote command:

[SENSe<Ch>:] SWEEp:TYPE LOGarithmic

### Segmented

In a "Segmented" frequency sweep the sweep range can be composed of several continuous frequency sub-ranges or single frequency points. The sub-ranges are termed sweep segments and defined in the "Define Segments" dialog. Sweep segments may overlap. The segment list must contain at least 2 distinct frequency points before a segmented frequency sweep can be started.

Instrument settings such as the internal generator power, the measurement (IF) bandwidth, and the frequency band of the local oscillator can be set independently for the individual segments.

Due to this flexibility, segmented frequency sweeps are suitable for any detailed analysis of a DUT at specified frequencies. In a Cartesian diagram the measurement result is displayed as a trace over a linear frequency scale ranging from the lowest to the highest frequency point of all segments. The following example shows a segmented frequency sweep with 2 segments in the stimulus ranges between 1 GHz and 6 GHz and between 4 GHz and 5 GHz, respectively. The forward transmission parameter  $S_{21}$  is measured, and a "dB Mag" scaled y-axis is used. In the frequency range between the sweep segments the trace is displayed as a straight line.



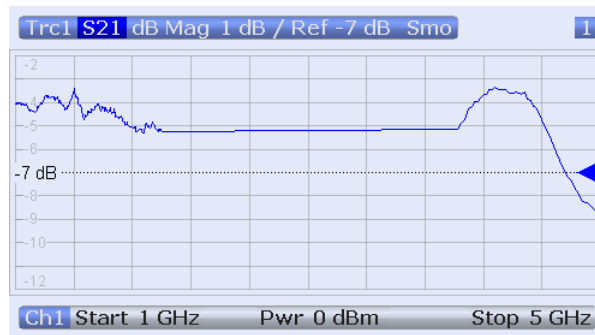

**Tip:** You can change to point based x-axis to improve the display of a segmented frequency sweep (see "Seg x-Axis" on page 243).

Remote command:

```
[SENSe<Ch>:] SWEep:TYPE SEGment
```

### Power

In a "Power" sweep the internal generator power is swept in linear, equidistant steps over a continuous power range. The generator power range (sweep range) is defined via "STIMULUS > START" and "STIMULUS > STOP". The fixed frequency can be defined via "CHANNEL > SWEEP > Sweep Params > CW Frequency".

"Power" sweeps are particularly suitable for the analysis of non-linear effects (saturation, compression) on active and passive DUTs (e.g. power amplifiers, mixers).

In a Cartesian diagram the measurement result is displayed as a trace over a dB-linear power scale. The following example shows a "Power" sweep in the source power range between -25 dBm and 0 dBm, performed at a CW frequency of 1 GHz.

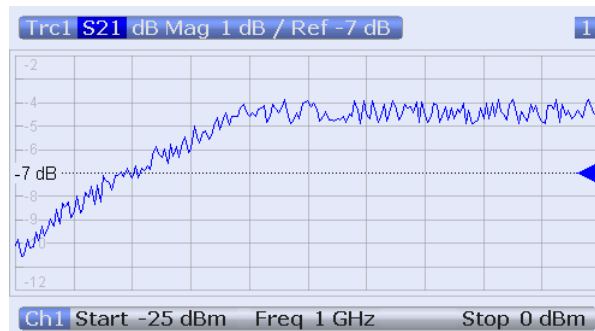

### Tip: Generator power

The power range for a power sweep replaces the fixed internal source power which is defined via "POWER BW AVG > Power". The power is the output power at all test ports which supply the stimulus signals for the active channel.

Remote command:

```
[SENSe<Ch>:] SWEep:TYPE POWer
```

### CW Mode

"CW Mode" sweeps, like "Time" sweeps, are performed at constant frequency and stimulus power. The measurement is triggered according to the current trigger settings; each trigger event triggers the first partial measurement of a measurement point. The time interval between two consecutive measurements depends on the trigger settings and the sweep parameters (especially the number of points). Any trigger mode is allowed.

The frequency ("CW Frequency") and internal source power ("Power") are fixed. Both can be defined in the "CHANNEL > SWEEP > Sweep Params" tab.

A "CW Mode" sweep corresponds to the analysis of a signal over the time with a time scale and resolution that is determined by the trigger events. In a Cartesian diagram the measurement result is displayed as a trace over a linear time scale (like e.g. in an oscilloscope). The diagram is similar to the "Time" diagram. The following example shows a "CW Mode" sweep with a DUT that does not markedly change its transmission characteristics over the time.

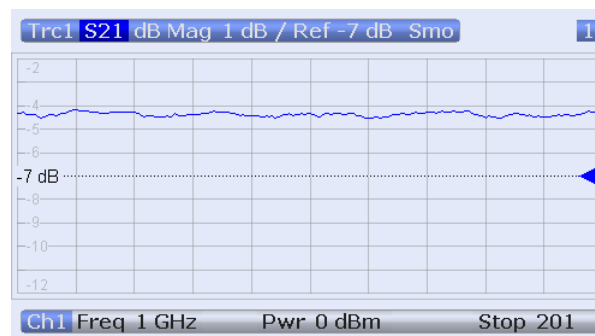

### Tip: Sweep time

The time interval between two consecutive trigger pulses must not be smaller than the minimum measurement time per measurement point. See ["Sweep Time / Auto"](#) on page 238.

Remote command:

```
[SENSe<Ch>:] SWEEp:TYPE POINTt
```

### Time

"Time" sweeps are performed at constant frequency and stimulus power. A single sweep extends over a specified period of time. The sweep time is defined via "STIMULUS > STOP"; see [Chapter 3.1.4.3, "Stimulus and Sweep Types"](#), on page 17. The time intervals between two consecutive sweep points are calculated according to  $\text{<Stop>}/(n - 1)$  where  $n$  is the selected "Number of Points". The frequency ("CW Frequency") and internal source power ("Power") are fixed. Both can be defined in the "CHANNEL > SWEEP > Sweep Params" tab.

A "Time" sweep corresponds to the analysis of a signal over the time; the function of the analyzer is analogous to an oscilloscope. In a Cartesian diagram the measurement result is displayed as a trace over a linear time scale. The following example shows a "Time" sweep with a DUT that does not markedly change its transmission characteristics over the time.

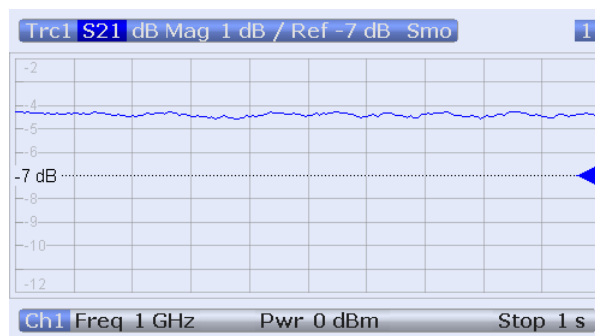

### Tip: Sweep time

The minimum sweep time depends on the number of measurement points, the measurement bandwidth, the delay time before each partial measurement and the number of partial measurements required for each measurement point. The analyzer estimates this time, taking into account the current measurement settings.

If the total sweep time entered via "STIMULUS > STOP" is smaller than the estimated minimum sweep time, the entered value is increased automatically.

### Equidistance of sweep points

The analyzer tries to keep the time intervals between any two consecutive time sweep points equal: The time sweep samples are equidistant. Equidistance also holds for sweeps which range over several channels.

Remote command:

[SENSe<Ch>:] SWEEp:TYPE CW

### Seg x-Axis

Scales the x-axis for a segmented frequency sweep:

- In frequency based mode, the x-axis covers the frequency ranges of all sweep segments, including possible gaps between the segments. Equal frequency spacings correspond to equal distances on the x-axis.
- In point based mode, the x-axis shows all sweep points with equal spacings. Gaps between sweep segments are minimized; no diagram space is "wasted" on unused frequency ranges. Point based mode is indicated in the channel line.

The example below shows a segmented frequency sweep with two segments. The first segment ranges from 1 GHz to 1.4 GHz; the second segment from 2 GHz to 3 GHz. Both segments contain 11 sweep points. In point based mode (lower diagram), all sweep points are equidistant.

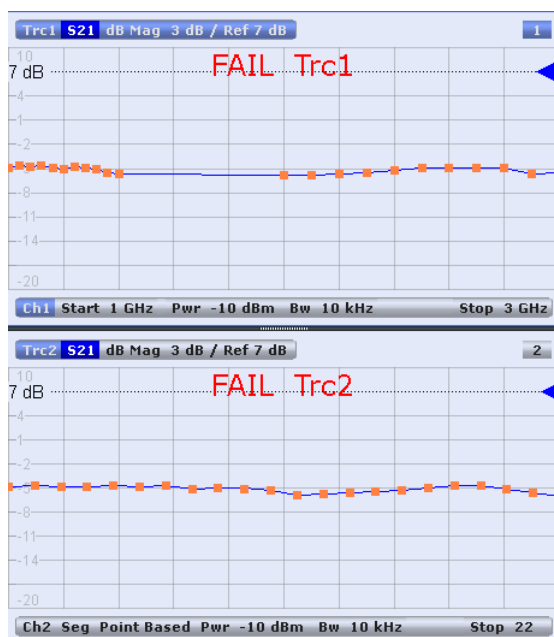

**Tip:** Overlapping limit line and ripple limit line segments are not displayed when a point-based x-axis is active; see [Chapter 3.4.1.1, "Rules for Limit Line Definition"](#), on page 64.

Remote command:

[SENSe<Ch>:] FREQuency:SEGment:AXIS

#### 4.4.2.3 Define Segments (Dialog)

The "Define Segments" dialog defines all channel settings for a "Segmented" frequency sweep and imports or exports segmented sweep settings.

The dialog contains a table to edit the individual segments of the sweep range. Sweep segments may have common points or even overlap.

See also "[Segmented](#)" on page 240.

**Access:** CHANNEL > SWEEP > Sweep Type > Define Segments...

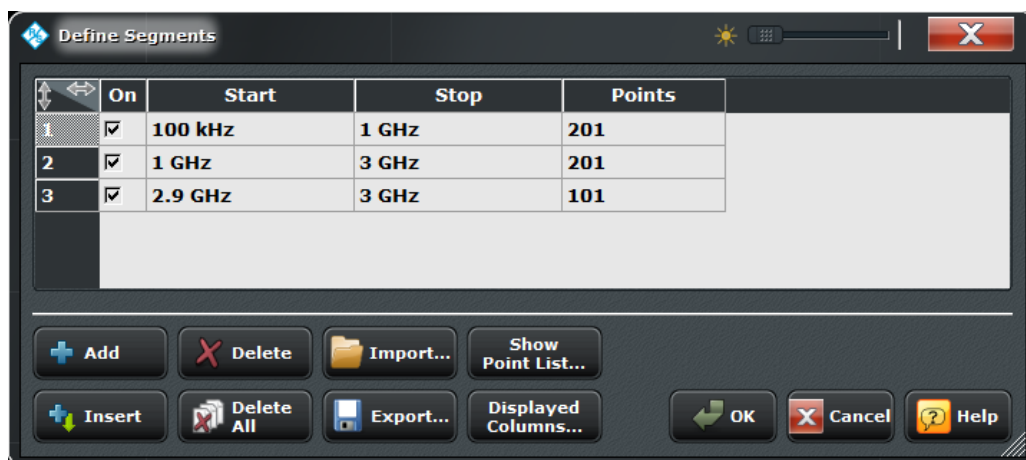

### Table Columns

The table in the upper part of the "Define Segments" dialog contains an automatically assigned current number for each segment plus the following editable or non-editable columns:

- "On" provides check boxes to activate or deactivate each individual segment. "Sweep" points in inactive segments are not measured and not listed in the "Point List".
- "Start" is the stimulus (x-axis) value of the first point of the segment. If the segment contains more than one "Point", then "Start" must be smaller than the "Stop" value. If a "Start" value equal to or larger than the current "Stop" value is set, "Stop" is adjusted to the new "Start" value plus 1 Hz.
- "Stop" is the stimulus (x-axis) value of the last point of the segment. If the segment contains more than one "Point", then "Stop" must be larger or equal than the "Start" value. If a "Stop" value equal to or smaller than the current "Start" value is set, "Start" is adjusted to the new "Stop" value minus 1 Hz.
- "Points" is the number of sweep points in the segment. A single segment can consist of only one point. If "Points" is set to 1, then the "Stop" frequency is set equal to the "Start" frequency.

### Note: Displayed Columns and Segment-specific Measurement Settings

The remaining columns allow to replace channel-wide measurement settings by segment-specific ones. These columns are only displayed - and the corresponding segment-specific values are only applied - if they are selected in the [Displayed Columns Dialog](#).

### Note: Limitations for overlapping segments

When overlapping sweep segments are created, the marker functions, trace evaluation functions, trace search functions and band filter functions are still available. It is possible, however, that these tools show an unexpected behavior when used in overlapping sweep segments. The reason is that the assignment of markers to traces in overlapping segments is ambiguous. To avoid any problem, it is recommended to turn off the sweep segments that overlap with the one that needs to be analyzed in detail with the aid of a marker function.

Remote command:

```
[SENSe<Ch>:] SEGMENT:COUNT?
[SENSe<Ch>:] SEGMENT<Seg>[:STATE]
[SENSe<Ch>:] SEGMENT<Seg>:FREQUENCY:START
[SENSe<Ch>:] SEGMENT<Seg>:FREQUENCY:STOP
[SENSe<Ch>:] SEGMENT<Seg>:FREQUENCY:CENTER?
[SENSe<Ch>:] SEGMENT<Seg>:FREQUENCY:SPAN?
[SENSe<Ch>:] SEGMENT<Seg>:SWEeP:POINTs
```

### Add / Insert / Delete / Delete All

The four buttons below the segment list extend or shorten the list.

- "Add" adds a new segment to the end of the list. The added segment covers a possible frequency gap between the preceding segment and the upper frequency limit of the analyzer. The start frequency of the new segment is set equal to the stop frequency of the preceding segment (minus 1 Hz, if this value is already equal to the upper frequency limit). The stop frequency is equal to the upper frequency limit. The number of points is 51.

- "Insert" inserts a new segment before the active segment. The segment numbers of all segments after the new segment are incremented by one. The new segment covers a possible frequency gap between the two adjacent segments. If there is no gap, the stop frequency of the inserted segment is set to the start frequency of the next segment; the start frequency is equal to the stop frequency minus 1 Hz. A new segment which is inserted before segment no. 1 starts at the lower frequency limit of the analyzer. The number of points is 51.
- "Delete" removes the selected segment from the list.
- "Delete All" clears the entire segment list so it is possible to define or load a new segmented sweep range.

Remote command:

```
[SENSe<Ch>:] SEGment<Seg>:ADD
[SENSe<Ch>:] SEGment<Seg>:INSert
[SENSe<Ch>:] SEGment<Seg>:DELete [:DUMMy]
[SENSe<Ch>:] SEGment<Seg>:DELete:ALL
```

### Show Point List...

Opens a list of all active sweep points and their channel settings. All columns except Pnt # and Frequency are displayed only if they are explicitly selected; see [Chapter 4.4.2.4, "Displayed Columns Dialog"](#), on page 247.

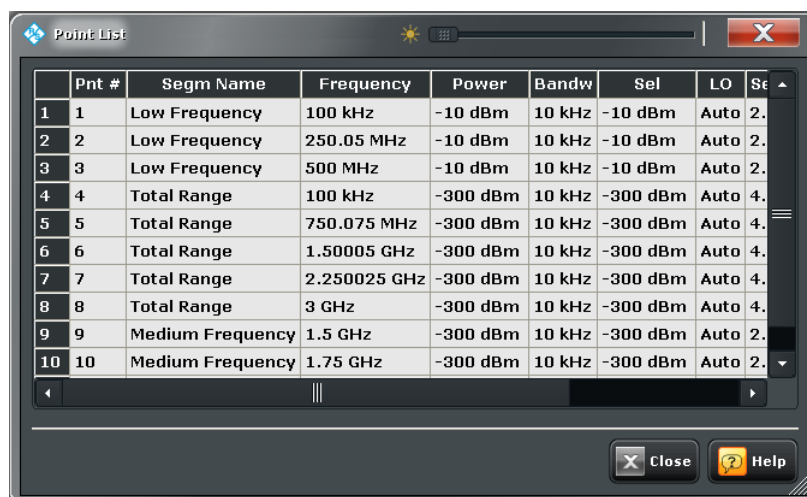

	Pnt #	Segm Name	Frequency	Power	Bandw	Sel	LO	Se
1	1	Low Frequency	100 kHz	-10 dBm	10 kHz	-10 dBm	Auto	2.
2	2	Low Frequency	250.05 MHz	-10 dBm	10 kHz	-10 dBm	Auto	2.
3	3	Low Frequency	500 MHz	-10 dBm	10 kHz	-10 dBm	Auto	2.
4	4	Total Range	100 kHz	-300 dBm	10 kHz	-300 dBm	Auto	4.
5	5	Total Range	750.075 MHz	-300 dBm	10 kHz	-300 dBm	Auto	4.
6	6	Total Range	1.50005 GHz	-300 dBm	10 kHz	-300 dBm	Auto	4.
7	7	Total Range	2.250025 GHz	-300 dBm	10 kHz	-300 dBm	Auto	4.
8	8	Total Range	3 GHz	-300 dBm	10 kHz	-300 dBm	Auto	4.
9	9	Medium Frequency	1.5 GHz	-300 dBm	10 kHz	-300 dBm	Auto	2.
10	10	Medium Frequency	1.75 GHz	-300 dBm	10 kHz	-300 dBm	Auto	2.

### Import... / Export...

The buttons open standard dialogs to import and export sweep segment settings.

- "Import..." loads a sweep segment list from a sweep segment file.
- "Export..." stores the current sweep segments to a sweep segment file.

### Sweep segment files

The analyzer uses a simple ASCII format to export sweep segment data. By default, the sweep segment file extension is \*.SegList. The file starts with two comment lines containing the version and a third line reproducing the header of the segment list. The following lines contain the entries of all columns of the segment list, including the "Displayed Columns" that may be hidden in the "Define Segments" dialog.

**Example:**

The segmented sweep range

	Name ^	On	Start	Stop	Points	Pwr (Pb)	Bar
1	Low Frequency	<input checked="" type="checkbox"/>	9 kHz	9.001 kHz	5	0 dBm	10 kHz
2	Total range	<input checked="" type="checkbox"/>	9 kHz	8.5 GHz	5	0 dBm	10 kHz
3	Medium frequency	<input checked="" type="checkbox"/>	4 GHz	5 GHz	5	0 dBm	10 kHz

is described by the following sweep segment file:

```
# Version 1.00
#
bo:State,str:Name,start Frequency[MHz],stop Frequency[MHz],int:No of Points,source Power [dBm],IF Ban
true,Low Frequency,8.999999999999999E-003,9.001000000000000E-003,5,0.000000000000000E+000,1.00000000
true,Total range,8.999999999999999E-003,8.500000000000000E+003,5,0.000000000000000E+000,1.0000000000
true,Medium frequency,4.000000000000000E+003,5.000000000000000E+003,5,0.000000000000000E+000,1.00000000
```

**Note:** The sweep segment file actually contains more columns listing all channel settings of the individual sweep segments. The headings of the additional columns read: *IF Bandwidth [Hz]; enIF Selectivity; en IF Sideband; Meas Delay [μs]; boSweep Time Auto*

Remote command:

`MMEMemory:LOAD:SEGment`

`MMEMemory:STORe:SEGment`

#### 4.4.2.4 Displayed Columns Dialog

The "Displayed Columns" dialog selects the segment-specific channel settings that the analyzer displays in the "Define Segments" and in the "Point List" dialogs.

All settings can be adjusted in the "Define Segments" dialog. By default, the first sweep segment is created with the channel settings defined for unsegmented sweep types. When any further sweep segment created, it uses the channel settings of the previously active segment.



#### Related information

Refer to the following sections:

- [Chapter 4.4.2.3, "Define Segments \(Dialog\)"](#), on page 244
- ["Show Point List..."](#) on page 246

**Access:** CHANNEL > SWEEP > Sweep Type > Define Segments... > Displayed Columns...

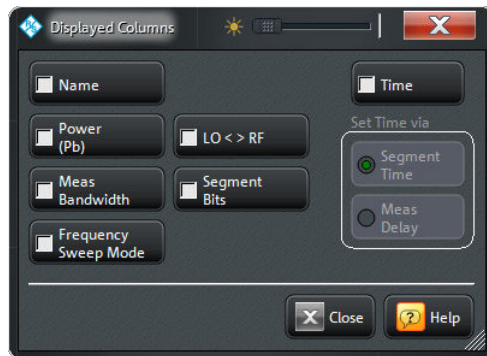

### Table Columns

Each selected (checked) option adds a column to the segment list.

- "Name" adds a column to assign a name to each segment. A segment name is a string that may contain letters, numbers and special characters.
- "Power (Pb)" defines the internal source power for each individual sweep segment. See ["Power"](#) on page 230.
- "Meas Bandwidth" defines the IF filter bandwidth for each individual sweep segment. See ["Bandwidth"](#) on page 234.
- "LO <> RF" defines whether the analyzer measures the segment with a local oscillator frequency LO below or above the RF input frequency, or if it should use automatic "spur avoidance". This overrides the channel's "Image Suppr." setting for particular segments; see ["Image Suppr."](#) on page 301.

**Note:** For a unidirectional R&S ZND (see [Chapter 3.1.4.2, "R&S ZND: Unidirectional vs. Bidirectional Operation"](#), on page 16) only the automatic mode is available; hence this control is disabled and the corresponding column is always hidden.

- "Segment Bits" enables the definition of a segment-dependent four-bit binary value to control four independent output signals at the USER PORT connector (lines 16, 17, 18, 19; see [Chapter 9.1.1.1, "USER PORT"](#), on page 803). The output signals are 3.3 V TTL signals which can be used to differentiate between up to 16 independent analyzer states. Setting the segment bits does not change the analyzer state.
- "Time" defines the sweep time for each segment. The default configuration for a new segment is equal to the sweep time setting for unsegmented sweeps; see ["Sweep Time / Auto"](#) on page 238.

When "Time" is checked two new columns appear in the table. The first column reads "Segment Time" or "Meas Delay", depending on the selected radio button below the "Time" checkbox. The second column reads "Auto" and is used to activate automatic sweep time setting.

"Segment Time" is the total measurement time for the sweep segment. The minimum segment sweep time to be set is equal to the estimated value in "Auto" mode. "Meas Delay" sets a delay time allowing the DUT to settle before the hardware settings of the analyzer are changed and a new partial measurement is started.

Changing the "Meas Delay" modifies the "Segment Time" and vice versa.

"Auto" minimizes the sweep time. If this option is checked, the columns "Segment Time" or "Meas Delay" cannot be edited. "Segment Time" indicates the estimated sweep time, depending on the current measurement settings, the "Meas Delay" is 0 s. The segment sweep time and point delay values are maintained until changed explicitly if "Auto" is switched off.



Remote command:

```
[SENSe<Ch>:] SEGMENT<Seg>:POWER[:LEVel]
[SENSe<Ch>:] SEGMENT<Seg>:POWER[:LEVel]:CONTRol
[SENSe<Ch>:] SEGMENT<Seg>:POWER[:LEVel]:CONTRol
[SENSe<Ch>:] SEGMENT<Seg>:BWIDth[:RESolution]
[SENSe<Ch>:] SEGMENT<Seg>:BWIDth[:RESolution]:CONTRol
[SENSe<Ch>:] SEGMENT<Seg>:DEFine
[SENSe<Ch>:] SEGMENT<Seg>:DEFine:SElect
[SENSe<Ch>:] SEGMENT<Seg>:INSert
[SENSe<Ch>:] SEGMENT<Seg>:INSert:SElect
[SENSe<Ch>:] SEGMENT<Seg>:SWEep:DWELl
[SENSe<Ch>:] SEGMENT<Seg>:SWEep:DWELl:CONTRol
[SENSe<Ch>:] SEGMENT<Seg>:SWEep:TIME
[SENSe<Ch>:] SEGMENT<Seg>:SWEep:TIME:CONTRol
[SENSe<Ch>:] SEGMENT<Seg>:SWEep:TIME:SUM?
CONTRol:AUXiliary:C[:DATA]
```

#### 4.4.2.5 Sweep > Sweep Control

Selects the number of sweeps per measurement cycle. The sweep mode ("Continuous" or "Single") and the number of sweeps apply to the active channel or to all channels, depending on the "Restart Manager" settings (see [Chapter 4.4.2.6, "Restart Manager Dialog"](#), on page 251).

**Access:** CHANNEL > SWEEP key or Alt + Shift + M

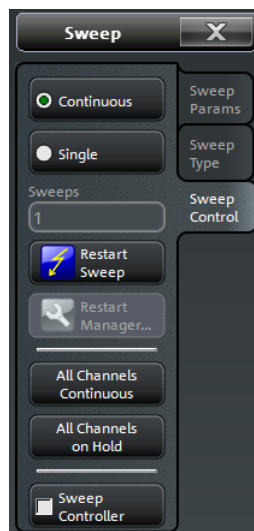

#### Continuous / Single

Activate either continuous or single sweep mode for the active channel.

- In "Continuous" mode, the analyzer measures continuously, repeating the current sweep.
- In "Single" sweep mode, the measurement is stopped after the number of selected "Sweeps". "Restart Sweep" initiates a new measurement cycle.

**Tip:** Use "All Channels Continuous" or "All Channels on Hold" to select a common sweep control mode for all channels.

Remote command:

```
INITiate<Ch>:CONTinuous
```

See also:

```
CONFigure:CHANnel<Ch>:MEASure[:STATe]
```

```
CONFigure:CHANnel:MEASure:ALL[:STATe]
```

### Sweeps

Selects the number of sweeps to be measured in single sweep mode: either one or a group of consecutive sweeps. The setting applies to the active channel.

In the R&S ZVAB compatibility mode (see ["Remote Language"](#) on page 346) the [Restart Manager Dialog](#) allows to define individual numbers of sweeps for all channels in the active recall set.

Remote command:

```
[SENSe<Ch>:]SWEep:COUNT
```

```
[SENSe:]SWEep:COUNT:ALL
```

### Restart Sweep

Stops the current measurement and restarts a measurement cycle. In "Single" sweep mode a new single sweep sequence is started.

Remote command:

```
INITiate<Ch>[:IMMediate][:DUMMy]
```

```
INITiate[:IMMediate]:ALL on page 542
```

See also ["Remote Language"](#) on page 346

### All Channels Continuous / on Hold

Selects a common sweep control mode for all channels of the active recall set.

- "All Channels Continuous:" The R&S ZNC/ZND continuously repeats the sweeps in all channels.
- "All Channels on Hold:" The R&S ZNC/ZND performs single sweeps, according to the channel-specific number of "Sweeps".

In R&S ZVAB compatibility mode (see ["Remote Language"](#) on page 346) the buttons are unavailable, however, you can use the "Restart Manager" dialog instead.

Remote command:

```
INITiate:CONTinuous:ALL
```

### Sweep Controller

Activates/deactivates the (resizable) "Sweep Info" dialog, which displays the current sweep stage. This is particularly useful for long duration sweeps, executed in single sweep mode: by observing the dialog it is easy to realize when the sweep is done.



The possible sweep stages and how they are displayed partly depend on the selected sweep mode (see "Continuous / Single" on page 249):

Sweep Stage	Sweep Controller Display	
	in Continuous Sweep Mode	in Single Sweep Mode
No ongoing sweep	<i>Idle</i>	<i>Idle</i>
Sweep is being prepared	<i>Preparing</i>	<i>Preparing</i>
Ongoing sweep <sup>1)</sup>	<i>Continuous</i>	<i>Sweeping</i> if #Sweeps = 1
		<i>Sweeping m/n</i> if n = #Sweeps > 1
Measurement results are being calculated	<i>Continuous Calculation</i>	<i>Calculation</i>
<sup>1)</sup> This doesn't mean the VNA is actually sweeping; it may also wait for a trigger signal		

#### 4.4.2.6 Restart Manager Dialog

The "Restart Manager" dialog defines whether the active sweep mode ("Continuous" or "Single") and the "Number of Sweeps" are valid for all channels in the active recall set or for the active channel only.

This dialog is relevant / accessible in the "ZVR" or "ZVABT" compatibility modes only (see "Remote Language" on page 346).



#### Related information

Refer to [Chapter 4.4.2.5, "Sweep > Sweep Control"](#), on page 249.

**Access:** CHANNEL > SWEEP > Sweep Control > Restart Manager...



### Sweep All Channels

Apply the sweep control settings to all channels in the active recall set. The number of sweeps in a "Single" sweep sequence is equal to the selected number of "Sweeps" times the number of channels. The sequence starts with the first sweep in channel no. 1.

**Tip:** In remote control, it is possible to retrieve the results acquired in any of the sweeps within a single sweep group.

Remote command:

```
INITiate<Ch>[:IMMediate]:SCOPE ALL
[SENSe<Ch>:]SWEep:COUNT
```

### Sweep Active Channel

Apply the sweep control settings to the active channel only. The number of sweeps in a "Single" sweep sequence is equal to the number of "Sweeps" in the active channel.

The table lists all channels in the active recall set and allows you to define individual numbers of sweeps for all channels. When a new channel is selected, the analyzer uses its specific number of sweeps.

Remote command:

```
INITiate<Ch>[:IMMediate]:SCOPE SINGLE
[SENSe<Ch>:]SWEep:COUNT
```

## 4.4.3 Calibration

The "Calibration" menu provides all functions that are necessary to perform a system error correction and a scalar power calibration.

### 4.4.3.1 Calibration > Start Cal

Provides access to all functions for automatic or manual calibration. Calibration of the R&S ZNC/ZND is a fully menu-guided process.



### Background information

Refer to the following sections:

- [Chapter 3.5, "Calibration"](#), on page 73
- [Chapter 3.5.5, "Automatic Calibration"](#), on page 91
- [Chapter 3.5.6, "Scalar Power Calibration"](#), on page 97
- [Chapter 3.1.5, "Data Flow"](#), on page 18

**Access:** CHANNEL > CAL key or Alt + Shift + P



left = R&S ZNC or bidirectional R&S ZND  
right = unidirectional R&S ZND



The "Cal Unit" buttons are only active if a calibration unit is connected to the analyzer.

The "Calibration" buttons open the following wizards/screens:

- **Calibration > Start... (Cal Unit):** [Calibration Unit Wizard](#)
- **Calibration > Start... (Manual):** [Calibration Presetting Wizard](#)
- **Scalar Power Cal > Power Cal...:** [Power Cal Screen](#)



For a unidirectional R&S ZND (see [Chapter 3.1.4.2, "R&S ZND: Unidirectional vs. Bidirectional Operation"](#), on page 16) automatic calibration is not available and hence the "Start... (Cal Unit)" button is hidden.

**Repeat...** opens the last dialogs of the corresponding calibration wizard from where you can directly (re-)start the calibration sweeps, maintaining the calibration settings of the active channel calibration. They provide a convenient means of repeating or correcting a calibration.

#### 4.4.3.2 Calibration Unit Wizard

The "Calibration Unit" wizard guides you through the setup and execution of an automatic calibration.

The wizard proceeds through the following steps:

1. **Ports:** Select the calibrated test ports, the cal unit characterization, and the calibration type.
2. **Connections:** Define the port assignment(s) between the R&S ZNC/ZND and the calibration unit.
3. **Calibration:** Acquire measurement data for all standards required for the selected calibration type. Calculate the system error correction data (error terms) from the measurement data of the standards and apply the result to the active channel.



#### Background information

Refer to [Chapter 3.5.5, "Automatic Calibration"](#), on page 91.

---



- A successful calibration will supersede the previous calibration, discarding all previous system error correction data. To keep older correction data you can transfer them into a "Cal Pool" using the "Calibration Manager".
  - The system error correction data determined in a calibration procedure is stored in the analyzer. You can read these correction data using the remote control command `[SENSe<Ch>:]CORRection:CDATa`.
- 

#### Step 1: Ports

Selects the calibrated analyzer ports, the cal unit with its characterization, and the calibration type.

---



#### Background and related information

Refer to the following sections:

- [Chapter 3.5.1, "Calibration Types"](#), on page 74
  - [Chapter 3.5.5.3, "Characterization of Calibration Units"](#), on page 96
- 

**Access:** CHANNEL > CAL > Start Cal > Start... (Cal Unit)



Figure 4-4: Calibration Unit Wizard: Ports

### Ports

Selects the test port(s) to be calibrated.

**Note:** Calibration and port de-/activation.

The way the analyzer firmware activates/deactivates ports after a successful calibration (system error correction or power calibration) has slightly changed:

- In all FW releases, calibrated ports that were previously disabled, are automatically enabled as single-ended logical ports.
- Starting with FW version 2.10, uncalibrated ports were disabled in the related channel(s). If only one of the physical ports forming a balanced port was calibrated, the balanced port was dissolved and only the uncalibrated (single-ended) port was disabled.

In earlier FW versions there was no such port deactivation mechanism.

- Since FW version 2.40 an uncalibrated port is only disabled if it is not used by a measurement, i.e. if it is not required by any trace of the related channel.

Remote command:

The port parameters in many calibration commands define the calibrated port(s).

### Cal Unit

Displays the connected calibration units. The R&S ZNC/ZND auto-detects all calibration units which are connected to one of its USB ports. If several cal units are connected, one of them must be selected for calibration (active cal unit). A warning is displayed if the current sweep range of the network analyzer exceeds the characterized frequency range of the calibration unit.

For background information see [Chapter 3.5.5, "Automatic Calibration"](#), on page 91.

Remote command:

```
SYSTem:COMMunicate:RDEvice:AKAL:ADDRess:ALL?
SYSTem:COMMunicate:RDEvice:AKAL:ADDRess
```

### Characterization

Displays all characterizations which are stored in the active cal unit. The "Factory" characterization is available for all calibration units; it ensures an accurate calibration for all standard applications. To account for a modified test setup (e.g. the connection of additional adapters to the calibration unit), you can generate modified sets of characterization data using the cal unit characterization wizard; see [Chapter 4.4.3.10, "Characterize Cal Unit Dialog"](#), on page 281. By default, the R&S ZNC/ZND uses the last generated cal unit characterization.

**Tip:** If the characterization wizard is password-protected, the "Characterization" button is unavailable. Use this functionality to prevent inadvertent activation of inappropriate characterizations. See ["Authentication / Set Password"](#) on page 282.

See also [Chapter 3.5.5.3, "Characterization of Calibration Units"](#), on page 96.

Remote command:

```
SYSTem:COMMunicate:RDEvice:AKAL:CKIT:CATalog?
SYSTem:COMMunicate:RDEvice:AKAL:CKIT:STANdard:CATalog?
SYSTem:COMMunicate:RDEvice:AKAL:SDATa?
```

Query further cal unit properties:

```
SYSTem:COMMunicate:RDEvice:AKAL:DATE?
SYSTem:COMMunicate:RDEvice:AKAL:FRANge?
SYSTem:COMMunicate:RDEvice:AKAL:PORTs?
SYSTem:COMMunicate:RDEvice:AKAL:WARMup[:STATe]?
```

### Calibration Type / Source

Selects the calibration type for the selected physical port(s). For an overview refer to [Table 3-4](#).

The reflection calibration types can be used for any combination of physical ports: Reflection calibrations are simply repeated for each selected port. A transmission calibration type requires at least two physical ports. For the unidirectional transmission calibration types ("Trans Norm", "One Path Two Ports"), the direction ("**Source**" port) must be specified in addition.

**Note:** The transmission normalizations and the "One Path Two Ports Calibration" type require two-port (Through) characterization data for the cal unit, which may not be available on older calibration units or in user-defined cal unit characterization files. If a tooltip indicates missing two-port characterization data, simply perform a new characterization of your cal unit. In the first dialog of the "Characterization" wizard, select "Take All OSM and Through" to make sure the necessary two-port data is acquired. See also [Chapter 4.4.3.11, "Characterization Wizard"](#), on page 283.

Remote command:

```
[SENSe<Ch>:]CORRection:COLLect:AUTO:TYPE
[SENSe<Ch>:]CORRection:COLLect:AUTO:PORTs:TYPE
```



**Calibrate all Channels**

Check this box to apply the acquired correction data to all channels in the active recall set. Leave it unchecked (preset setting) to apply them only to the active channel.

Note that this option is available only if the active recall set contains multiple channels.

Remote command:

[SENSe:]CORRection:COLLect:CHANnels:ALL

**Next**

Proceeds to [Step 2: Connections](#). Next is unavailable (and a warning is displayed) if the following happens:

- The selected characterization data do not cover all the ports to be calibrated.
- The selected characterization data do not contain all standards needed for the selected calibration type.

**Step 2: Connections**

Defines the port assignment(s) between the R&S ZNC/ZND and the calibration unit.

**Access:** CHANNEL > CAL > Start Cal > Start... (Cal Unit) > Next

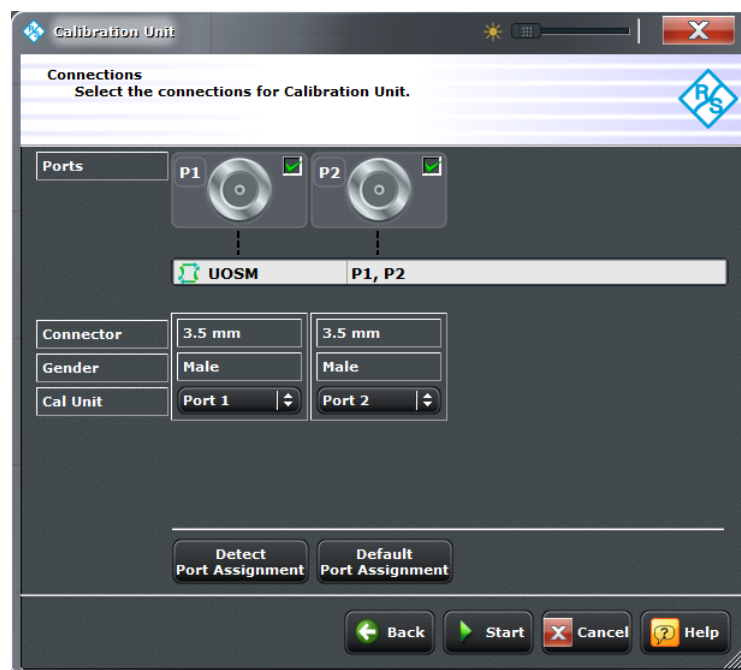
**Cal Type / Ports**

Displays the automatic calibration to be performed, identified by its calibration type and calibrated ports.

Remote command:

The port parameters in many calibration commands define the calibrated ports.

**Cal Unit / Port Assignments**

Displays the port assignment and allows to edit it.

### Detect Port Assignment

Starts a procedure by which the R&S ZNC/ZND (with a little help from the attached calibration unit) auto-detects the connected ports. The automatic assignment replaces the configured one.

In case auto-detection fails

- an error report is shown as a warning dialog
- the undetected port connections are overlaid by warning signs
- the calibration may be invalid



If auto-detection fails because of a high attenuation in the signal path, you can either enter the port assignment manually or connect matching port numbers and select "Default Port Assignment".

Remote command:

```
[SENSe:]CORRection:COLLect:AUTO:PORTs:CONNection?
```

### Default Port Assignment

Restores the default port assignment.

Remote command:

```
[SENSe:]CORRection:COLLect:AUTO:PORTs:CONNection?
```

### Start

Proceeds to [Step 3: Calibration](#) .

If the configured port assignments are invalid, this action is disabled.

### Step 3: Calibration

During the calibration phase the R&S ZNC/ZND displays a "Cal Unit" screen that guides the user through the actual correction data acquisition, whose setup was prepared during the previous wizard steps.

In each step

- the calibration unit has to be (re-)connected according to the depicted port assignment; auto-detection is possible
- the related test ports are calibrated with the same calibration type that was selected for in the [Step 1: Ports](#) page
- a subsweep is performed for each required test port (pair) and every required standard

When these steps have been completed, the resulting system error correction can be calculated and applied.

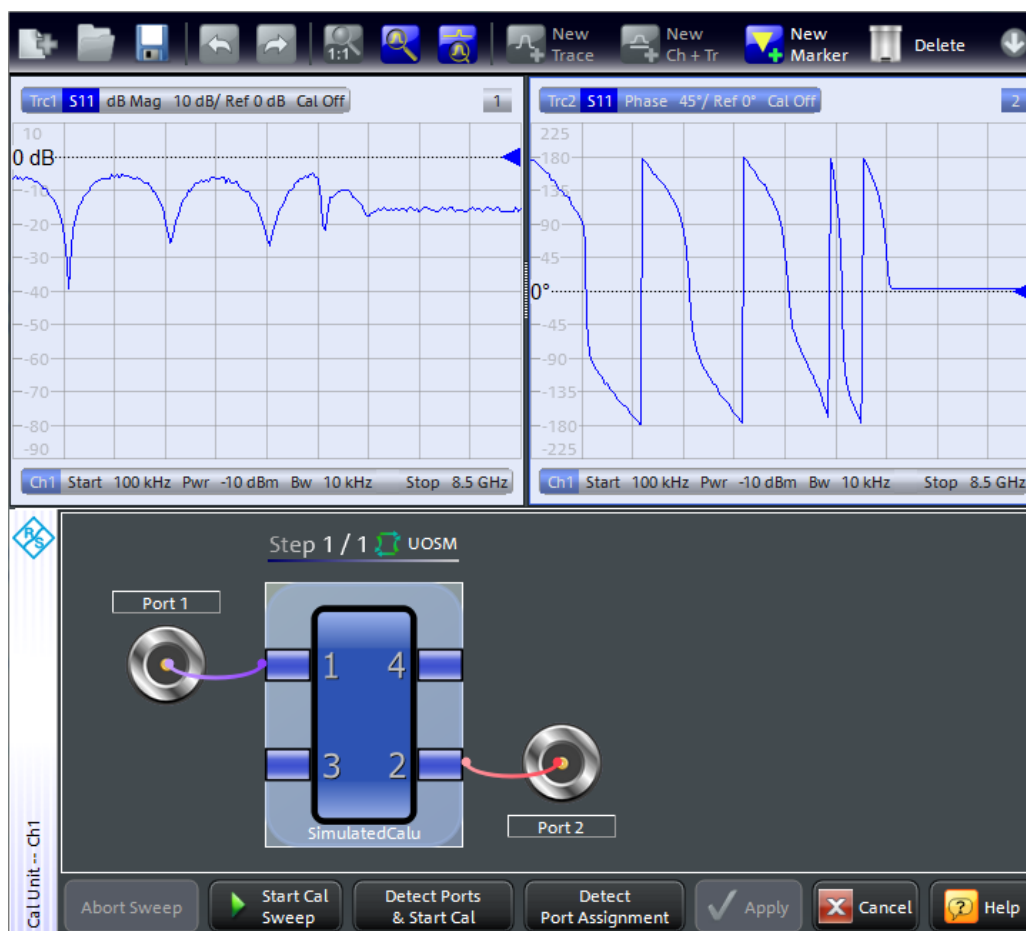

In the upper part of the "Cal Unit" screen, the R&S ZNC/ZND shows the calibration sweep diagrams for the currently measured S-parameter, the lower part visualizes the active port assignment and the measurement progress.

### Calibration Sweep Diagrams

Each diagram presents an S-parameter trace and a typical result trace for the measured standard type.

The purpose of the typical result traces "Trc1" and "Trc2" is to avoid connection errors: If the correct standard type is measured, and everything is properly connected, then the measured trace is expected to be similar to the typical trace.

The S-Parameter traces are labeled  $P[j\_i]_{\text{standard type}} S_{ij}$ , where  $j$  indicates the input (test) port and  $i$  indicates the output port, e.g.  $P[1\_2]_{\text{Through}} S_{21}$ .

Remote command:

n/a

### Start Cal Sweep / Abort Sweep

Starts the calibration sweep for the related port assignment or aborts it

### Detect Ports & Start Cal

Performs the "Detect Port Assignment" and Start Cal Sweep functions, one after the other.

### Detect Port Assignment

Starts a procedure by which the R&S ZNC/ZND (with a little help from the attached calibration unit) auto-detects the connected ports. The automatic assignment replaces the configured one.

In case auto-detection fails

- an error report is shown as a warning dialog
- the undetected port connections are overlaid by warning signs
- the calibration may be invalid



If auto-detection fails because of a high attenuation in the signal path, you can either enter the port assignment manually or connect matching port numbers and select "Default Port Assignment".

Remote command:

```
[SENSe:]CORRection:COLLect:AUTO:PORTs:CONNECTION?
```

### Apply/Cancel

Apply the calculated system error correction to the active channel (or to all channels in the active recall set, if all channels were calibrated).

The Apply button is enabled as soon as calibration sweeps have been successfully performed for all required port assignments.

Remote command:

```
[SENSe<Ch>:]CORRection:COLLect:AUTO
[SENSe<Ch>:]CORRection:COLLect:AUTO:PORTs
[SENSe<Ch>:]CORRection:COLLect:AUTO:PORTs:TYPE
[SENSe<Ch>:]CORRection:COLLect:AUTO:TYPE
```

Extended cal unit settings:

```
MMEMemory:AKAL:FACTory:CONVersion
MMEMemory:AKAL:USER:CONVersion
SYSTem:COMMunicate:AKAL:CONNECTION
SYSTem:COMMunicate:AKAL:MMEMemory[:STATe]
```

#### 4.4.3.3 Calibration Presetting Wizard

The "Calibration Presetting" wizard guides you through the setup and execution of a manual system error correction.

The wizard proceeds through the following steps:

1. **Ports and Type:** Select the ports to be calibrated and the calibration type to be used.
2. **Connectors and Cal Kits:** Select the connector type and gender for all ports to be calibrated. If necessary, load or modify a calibration kit.
3. **Calibration:** Acquire measurement data for the required ports or port pairs and the required standards. Finally, decide whether or not to apply the resulting system error correction.



#### Background information

Refer to [Chapter 3.5, "Calibration"](#), on page 73 for background information.

---



- If the active channel is already equipped with a system error correction, the "Calibration Presetting" wizard loads the underlying setup. If the calibration setup is not changed and sweep data are available from previous calibrations, the existing system error correction can be optimized without repeating the measurement of all standards.
  - When you apply the acquired system error correction, the active calibration is replaced and discarded.  
To persist any kind of calibration you can transfer it to the "Cal Pool" using the [Calibration Manager Dialog](#).
  - The active system error correction data can be read (and modified) using the remote control command `[SENSe<Ch>:]CORRection:CDATa`.
- 

#### Step 1: Ports and Type

Allows to select the test ports to be calibrated and the calibration type to be used.

---



#### Background information

Refer to [Chapter 3.5.1, "Calibration Types"](#), on page 74.

---

**Access:** CHANNEL > CAL > Start Cal > Start... (Manual)



Figure 4-5: Calibration Presetting: Ports and Type



For a unidirectional R&S ZND (see [Chapter 3.1.4.2, "R&S ZND: Unidirectional vs. Bidirectional Operation"](#), on page 16) only port 1 can operate as source port. Hence the "Source" selector is disabled and bidirectional calibrations such as Trans Norm Both, TOSM, UOSM etc. are not available.



### Ports

Selects the test port(s) to be calibrated.

**Note:** Calibration and port de-/activation.

The way the analyzer firmware activates/deactivates ports after a successful calibration (system error correction or power calibration) has slightly changed:

- In all FW releases, calibrated ports that were previously disabled, are automatically enabled as single-ended logical ports.
- Starting with FW version 2.10, uncalibrated ports were disabled in the related channel(s). If only one of the physical ports forming a balanced port was calibrated, the balanced port was dissolved and only the uncalibrated (single-ended) port was disabled.  
In earlier FW versions there was no such port deactivation mechanism.
- Since FW version 2.40 an uncalibrated port is only disabled if it is not used by a measurement, i.e. if it is not required by any trace of the related channel.

Remote command:

The port parameters in many calibration commands define the calibrated port(s).

#### Type / Source

Selects the calibration type. The green arrow symbols give a preview of the type and the number of calibration sweeps involved:

- Curved arrows (example: "Refl Norm Open") denote one or more reflection measurements at each port.
- Straight, horizontal arrows (example: "Trans Norm") denote one or more transmission measurements between each pair of two ports.
- The full n-port calibration types ( $n > 1$ , e.g. TOSM, TRL...) are symbolized by a closed square symbol. The number of arrows increases the complexity but can also improve the accuracy of the calibration.

The reflection calibration types can be used for any set of test ports: reflection calibrations are simply repeated for each port. A transmission calibration type requires at least two physical ports. For the unidirectional transmission calibration types ("Trans Norm", "One Path Two Ports"), the ("**Source**" port) must be specified in addition. For an overview refer to [Table 3-4](#).

Remote command:

```
[SENSe<Ch>:]CORRection:COLLect:METhod:DEFine
```

#### Calibrate all Channels

Check this box to apply the acquired correction data to all channels in the active recall set. Leave it unchecked (preset setting) to apply them only to the active channel.

Note that this option is available only if the active recall set contains multiple channels.

Remote command:

```
[SENSe:]CORRection:COLLect:CHANnels:ALL
```

#### Next

Proceeds to [Step 2: Connectors and Cal Kits](#).

#### Step 2: Connectors and Cal Kits

Selects the connector type and gender for all ports and allows you to import a calibration kit.



#### Background information

Refer to [Chapter 3.5.2, "Calibration Standards and Calibration Kits"](#), on page 85

---



### Messages in the dialog

An information (or error message) is displayed if one of the following happens:

- One of the selected calibration kits is described by ideal kit parameters or typical values.
- One of the selected calibration kits does not contain all standards that are required for the previously selected calibration type.
- Different connector types are defined at the ports but the selected calibration type requires uniform connectors.
- A cal kit standard does not cover the entire calibrated frequency range.

**Access:** CHANNEL > CAL > Start Cal > Start... (Manual) > Next



**Figure 4-6: Calibration Presetting: Connectors and Cal Kits**

The upper part of the panel shows the port(s) and the calibration type selected in [Step 1: Ports and Type](#). The lower part gives access to the connector and cal kit settings.

#### Connector / Gender

Defines the connector types and genders of the ports to be calibrated. For symmetric (sexless) connector types (e.g. 7 mm / PC7), "Gender" is unavailable.

If "Same Connector All Ports" is active, the connector types at all ports (but not their gender) are always adjusted to the current selection. If "Same Gender All Ports" is active, the genders at all ports are always adjusted to the current selection.

User-defined connectors can be added or removed in the [Cal Connector Types Dialog](#).



Remote command:

```
[SENSe<Ch>:]CORRection:COLLect:CONNection<PhyPt>
[SENSe<Ch>:]CORRection:COLLect:SCONnection<PhyPt>
[SENSe<Ch>:]CORRection:CONNection
[SENSe<Ch>:]CORRection:CONNection:CATalog?
[SENSe<Ch>:]CORRection:CONNection:DElete
```

### Cal Kit

Selects a cal kit for the connector at each selected physical port. The drop-down list contains all available calibration kits for the selected connector type. The assignment of a calibration kit to a connector type must be the same for all physical ports: If a calibration kit is changed, the R&S ZNC/ZND automatically assigns the new kit to all ports with the same connector type.

Use "Import Cal Kit..." to add new kits to the list.

Remote command:

```
[SENSe:]CORRection:CKIT:SElect
```

### Same Connector / Gender All Ports

Assigns the same connector type or gender to all selected physical ports. For some multi-port calibration types, the port connector types must be equal, e.g. because they require a Through standard with known characteristics.

Remote command:

```
[SENSe<Ch>:]CORRection:COLLect:CONNection:PORTs
[SENSe<Ch>:]CORRection:COLLect:CONNection:GENDeRs
```

### Import Cal Kit

Opens the Import Calibration Kit dialog to load and (if desired) activate a cal kit file. See [Chapter 3.5.2.4, "Cal Kit Files"](#), on page 89.

By default cal kit files are stored in the

C:\Users\Public\Documents\Rohde-Schwarz\Vna\Calibration directory.

- Three different **import** file formats are supported: R&S ZVA-specific binary cal kit files (\*.calkit), ZVR-specific binary cal kit files (\*.ck), cal kit files in Agilent-specific ASCII formats (\*.csv, \*.prn).

Remote command:

```
MMEMoRY:LOAD:CKIT
MMEMoRY:LOAD:CKIT:SDATa
```

### Back

Go back to [Step 1: Ports and Type](#).

### Start

Start [Step 3: Calibration](#).

### Step 3: Calibration

Allows to acquire error correction data for every required port (pair) and calibration standard, where "required" depends on the selected ports and calibration type. On

"Apply" the R&S ZNC/ZND calculates the system error correction (error terms) from the measurement data of the standards and applies the result to the active channel.

**Access:** CHANNEL > CAL > Start Cal > Start... (Manual) > Next > Next



Figure 4-7: Calibration Presetting: Calibration

In the upper part of the calibration screen, the R&S ZNC/ZND shows the calibration sweep diagrams for the currently measured S-parameter, the lower part displays the calibrated ports and standards and visualizes the measurement progress.



For a unidirectional R&S ZND (see [Chapter 3.1.4.2, "R&S ZND: Unidirectional vs. Bidirectional Operation"](#), on page 16) the TOSM calibration depicted above is not available.

### Calibration Sweep Diagrams

Each diagram presents an S-parameter trace and a typical result trace for the measured standard type.

The purpose of the typical result traces "Trc1" and "Trc2" is to avoid connection errors: If the correct standard type is measured, and everything is properly connected, then the measured trace is expected to be similar to the typical trace.

The S-Parameter traces are labeled  $P[j\_i]_{\langle \text{standard type} \rangle S_{ij}}$ , where  $j$  indicates the input (test) port and  $i$  indicates the output port, e.g.  $P[1\_2]_{\text{Through}} S_{21}$ .

Remote command:

n/a

### Ports and Standards

Shows the calibrated port(s) and standards and visualizes the measurement progress.

Use the buttons representing the calibration standards to start the corresponding calibration sweeps. If the [Show Cal Kit Label](#) flag is set in the "System Configuration" dialog, an additional "Calibration Info" dialog is displayed, from where the cal sweep is actually started.



[ "Don't show this dialog again" has the same effect as disabling "Show Cal Kit Label" in the system config.]

A green checkmark indicates that the calibration data of a standard has been acquired successfully. A green checkmark after the port symbol indicates that the minimum number of calibration measurements for the port has been performed.

#### Tip:

- If the selected calibration kit comprises a Sliding Match, then for every required Match measurement either the Match or at least three positions of the Sliding Match must be measured. See [Chapter 3.5.2.3, "Sliding Match Standards"](#), on page 88.
- For a TRL calibration, at least one line standard must be measured between any pair of calibrated ports. See [Chapter 3.5.1.9, "TRL Calibration"](#), on page 81.

Remote command:

```
[SENSe<Ch>:]CORRection:COLLect[:ACquire]:SElected
```

See also: `[SENSe<Ch>:]CORRection:COLLect:LOAD:SElected`

#### Restart Sweep on Std Meas

If this function is active, a new standard measurement initiates a new sweep, starting at the beginning ("Start") of the sweep range: The sweep points for the calibration sweep are in ascending order, like for an ordinary measurement.

If "Restart Sweep on Std Meas" is not active, the new standard measurement is started at the current sweep point; the current sweep is continued as a calibration sweep.

#### Apply

Is enabled as soon as sufficient data have been acquired for the calibrated ports and standards. The button starts the calculation of the system error correction and closes the calibration wizard. The current instrument settings is stored with the correction data.

To avoid incompatibilities, older calibration data is deleted unless it has been transferred into a "Cal Pool" using the [Calibration Manager Dialog](#).

**Note: Checks during the calculation of correction data**

Incompatibilities between the selected calibration type, the standards and the channel settings may cause the calibration to be inaccurate. The analyzer auto-detects potential sources of errors and displays appropriate, self-explanatory notice boxes.

Remote command:

```
[SENSe<Ch>:]CORRection:COLLect:SAVE:SELEcted[:DUMMy]
[SENSe<Ch>:]CORRection:COLLect:SAVE:SELEcted:DEFault
[SENSe<Ch>:]CORRection:COLLect:DELEte
[SENSe<Ch>:]CORRection:DATA:PARAmeter<Sfk>?
[SENSe<Ch>:]CORRection:DATE?
[SENSe<Chn>:]CORRection:SState?
[SENSe<Ch>:]CORRection:STIMulus?
```

#### 4.4.3.4 Power Cal Screen

The "Power Cal" screen shows the current source ("Power") and receive ("Meas. Receiver") ports and allows you to perform scalar source power calibrations (flatness calibrations) or measurement receiver calibrations, based on the current power calibration settings. If the active recall set contains several channels, an "Info" box lets you decide whether the R&S ZNC/ZND acquires calibration data for the active channel or for all channels.

**Access:** CHANNEL > CAL > Start Cal > Power Cal...

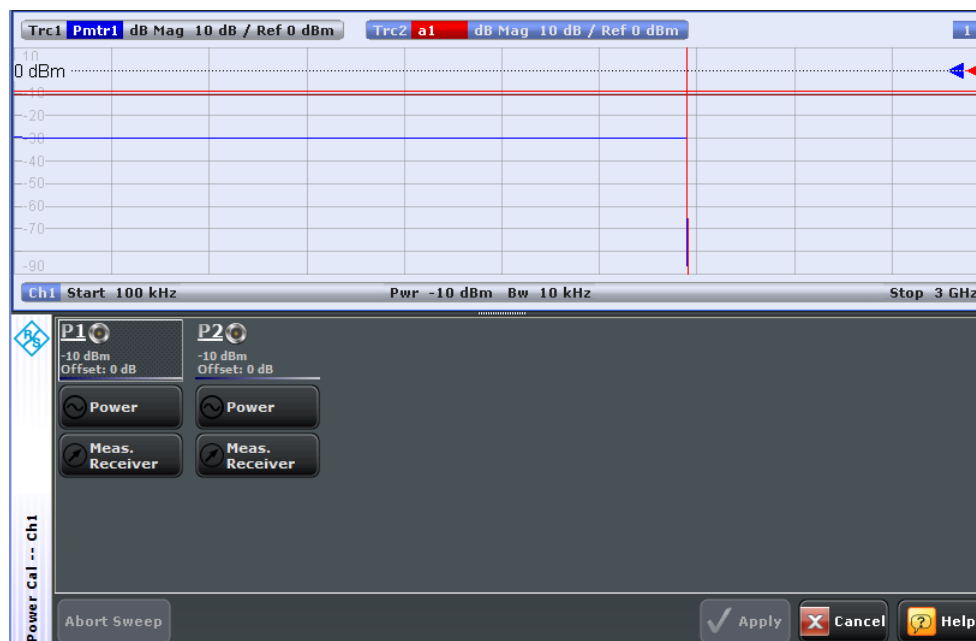



For a unidirectional R&S ZND (see [Chapter 3.1.4.2, "R&S ZND: Unidirectional vs. Bidirectional Operation"](#), on page 16) P2 cannot serve as source port. Hence only a calibration of the measurement receiver can be performed at P2.



### Screen Elements

From top to bottom, the screen consists of the following elements.

#### Calibration Sweep Diagram

The calibration sweep diagram in the upper part of the screen shows the progress of the calibration and the accuracy of a completed calibration ("Verification"). The diagram is scaled in "dB Mag" format.

The diagram title indicates the ongoing calibration type and reading. The traces in the diagram vary according to the calibration stage.

While no calibration is performed, or during a source power calibration ("Power"), the following traces are displayed:

- A limit line (double horizontal) represents the target power of the source power calibration ("Cal Power").
- "Pmtr<n>" shows the reading of the power meter Pmtr <n> in use. This trace is only shown during the first calibration sweeps; the following sweeps are based on the reference receiver result.
- "a<m>" shows the source power reading of the analyzer (wave quantity, reference receiver) at the calibrated source port P<m>.

After successful power calibration the trace a<m> should be close to the cal power.

During a measurement receiver calibration ("Meas. Receiver"), the following traces are displayed:

- The trace b<n> shows the current power reading of the analyzer at the calibrated receive port P<n>.
- The trace a<m> shows the (previously calibrated) power at the calibrated reference plane (source port P<m>).

After successful measurement receiver calibration, the b<n> trace should be close to the a<m> trace. Due to the previous power calibration, both traces should be close to the cal power.

Remote command:

```
SOURce<Ch>:POWer<PhyPt>:CORRection[:ACQuire]:VERification:
RESult?
```

#### Port Overview

Shows all source ports together with the possible power calibrations. Either a source power calibration (flatness calibration, "Power") or a measurement receiver calibration ("Meas. Receiver") can be performed at each analyzer port P1 ... PN.

Select a "Power" or "Meas. Receiver" symbol to open the "Power Cal" dialog and perform a calibration sweep. A green checkmark indicates that the calibration data has been acquired successfully.

See also ["Power Cal – Power \(Dialog\)"](#) on page 270 and ["Power Cal – Meas. Receiver \(Dialog\)"](#) on page 271.

Remote command:

```
n/a, see SOURCE<Ch>:POWER<PhyPt>:CORREction[:ACQuire]
[SENSe<Ch>:]CORREction:POWER<PhyPt>:ACQuire
SOURCE<Ch>:POWER:CORREction:DATA:PARAmeter<Wv>?
SOURCE<Ch>:POWER<PhyPt>:CORREction:DATA:PARAmeter<Wv>:COUNT?
```

### Apply

Is enabled as soon as a new set of power calibration data has been acquired for either a "Power" source or a "Meas. Receiver". The button applies all available source and/or measurement receiver calibrations to the active channel, aborts the verification sweeps, and closes the port overview section.

The power calibration state is indicated in the trace list, see [Chapter 3.5.6.3, "Power Calibration Labels"](#), on page 100. Use the functions in the "Use Cal" panel to activate, deactivate, or store power calibrations.

Remote command:

```
SOURCE<Ch>:POWER<PhyPt>:CORREction[:ACQuire]
[SENSe<Ch>:]CORREction:POWER<PhyPt>:ACQuire
SOURCE<Ch>:POWER:CORREction:DATA
[SENSe<Chn>:]CORREction:PState?
```

### Power Cal – Power (Dialog)

The "Power Cal – Power" dialog guides you through the power calibration for a particular source port (flatness and reference receiver calibration). Measurement receiver calibration is described in ["Power Cal – Meas. Receiver \(Dialog\)"](#) on page 271.



### Background information

Refer to [Chapter 3.5.6.1, "Source Power Calibration"](#), on page 98.

---

**Access:** CHANNEL > CAL > Start Cal > Power Cal... > Power

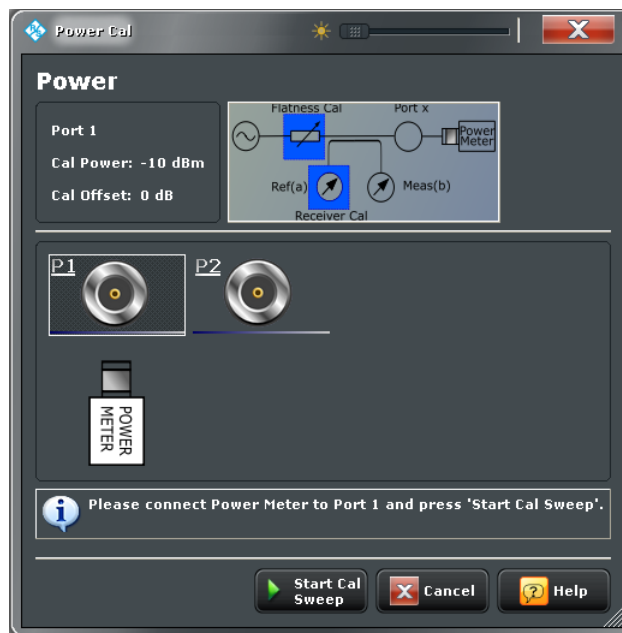

### Port Overview

The dialog shows all source ports of the network analyzer. The selected port is displayed with the current cal power settings (see [Chapter 4.4.3.13, "Modify Cal Power Dialog"](#), on page 288); moreover, a circuit diagram visualizes the purpose of the flatness and reference receiver calibration. A power meter must be connected to the calibrated port.

Remote command:

```
SOURce<Ch>:POWER<PhyPt>:CORRection[:ACQuire]
```

### Start Cal Sweep

Start the calibration sweep(s) for the selected port and power calibration settings and close the dialog. The calibration is performed as described in ["Calibration procedure"](#) on page 98.

Open the "Pwr Cal Settings" softtool panel if you wish to modify the calibration procedure.

Remote command:

```
SOURce<Ch>:POWER<PhyPt>:CORRection[:ACQuire]
SOURce<Ch>:POWER<PhyPt>:CORRection:COLLect[:ACQuire]
```

### Power Cal – Meas. Receiver (Dialog)

The "Power Cal – Meas. Receiver" dialog guides you through the power calibration for a particular receiver port.

"Meas. Receiver" calibrates the **measurement** receiver only; the "reference" receiver is calibrated together with the source. To ensure accurate source signal powers, a source power calibration is required prior to the measurement receiver calibration.



### Background information

Refer to [Chapter 3.5.6.2, "Measurement Receiver Calibration"](#), on page 99.

**Access:** CHANNEL > CAL > Start Cal > Power Cal... > Meas. Receiver



### Port Overview

The dialog shows all receiver ports of the network analyzer. The selected port is displayed with the current cal power settings (see [Chapter 4.4.3.13, "Modify Cal Power Dialog"](#), on page 288); moreover, a circuit diagram visualizes the purpose of the measurement receiver calibration.

"Source Port" defines the type of measurement receiver calibration:

- If the source port is equal to the calibrated port  $P_n$ , the measurement receiver is calibrated by the wave  $a_n$  which is reflected back by a connected Open or Short standard. A reference receiver power calibration must be active to ensure accurate source powers  $a_n$ .  
Connect the Open or Short standard to the calibrated port; no additional external test setup is required.
- If the source port and the calibrated port  $P_n$  are different, the measurement receiver is calibrated by the wave  $b_n$  from the other port. A source power calibration for  $b_n$  must be active.  
Connect the source port to the calibrated port, including any external devices that you used for the source power calibration.

Remote command:

`[SENSe<Ch>:]CORRection:POWer<PhyPt>:ACQuire`



**Start Cal Sweep**

Start the calibration sweep for the selected port and power calibration settings and close the dialog. The calibration is performed as described in "[Calibration procedure](#)" on page 99. No additional calibration settings are needed.

Remote command:

```
[SENSe<Ch>:]CORRection:POWer<PhyPt>:ACQuire
[SENSe<Ch>:]CORRection:POWer:DATA
```

**4.4.3.5 Calibration > Cal Devices**

Provides access to all functions for calibration kit management and cal unit characterization.

**Background information**

Refer to the following sections:

- [Chapter 3.5.2, "Calibration Standards and Calibration Kits"](#), on page 85
- [Chapter 3.5.5.3, "Characterization of Calibration Units"](#), on page 96

**Access:** CHANNEL > CAL key or Alt + Shift + P



left = R&S ZNC or bidirectional R&S ZND

right = unidirectional R&S ZND

The "Cal Devices" buttons open the following dialogs:

- **Cal Connector Types...:** See [Chapter 4.4.3.6, "Cal Connector Types Dialog"](#), on page 273
- **Cal Kits...:** See [Chapter 4.4.3.7, "Calibration Kits Dialog"](#), on page 276
- **Characterize Cal Unit...:** See [Chapter 4.4.3.10, "Characterize Cal Unit Dialog"](#), on page 281



For a unidirectional R&S ZND (see [Chapter 3.1.4.2, "R&S ZND: Unidirectional vs. Bidirectional Operation"](#), on page 16) calibration unit characterization is not available.

**4.4.3.6 Cal Connector Types Dialog**

The "Cal Connector Types" dialog displays and modifies the list of available connector types. Cal connector types must be selected in accordance with the connectors of the measured DUT.

**Access:** CHANNEL > CAL > Calibration > Cal Connector Types ...

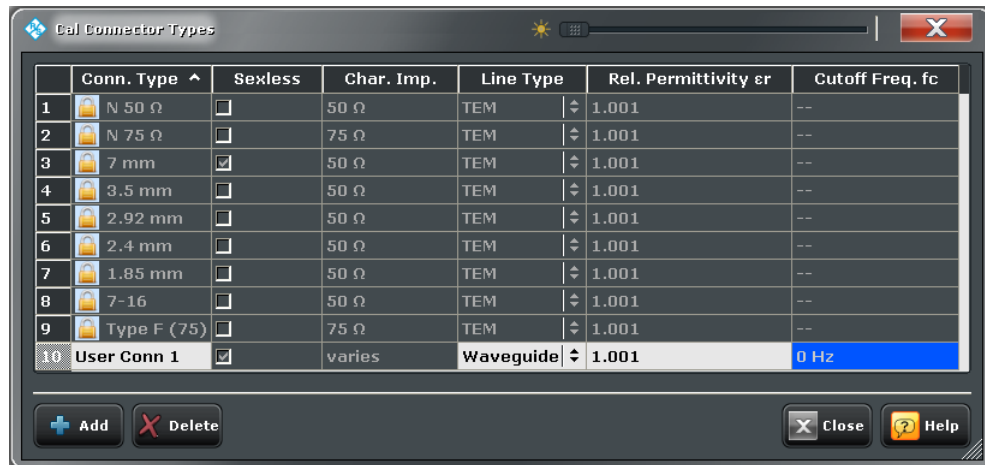

The list shows the available connector types with their name ("Conn Type"), polarity ("Sexless"). The remaining columns in the list are described below.



### Storing connector type settings

Calibration kits and connector types are global resources; the parameters are stored independently and available for all recall sets. The connector type settings are always stored together with the associated calibration kit parameters. The "Calibration Kits" provides buttons to export and import cal kit and connector settings.



After assigning a calibration kit to a user-defined connector type, you can still change its name, offset model and reference impedance. Switching between sexed and sexless will delete all kits assigned to the connector type.

### Char. Imp.

The characteristic impedance or reference impedance ("Char. Imp.")  $Z_0$  for the connectors is a critical value that has an impact on various parameter conversions.  $Z_0$  enters into:

- The calculation of the S-parameters for the calibration standards associated with the connector type, provided that they are derived from a circuit model (see [Chapter 4.4.3.9, "View / Modify Cal Kit Standards Dialog"](#), on page 279).
- The calculation of the (default) reference impedances for balanced ports (see ["Reference Impedance"](#) on page 134).
- The calculation of impedance and admittance parameters (see [Chapter 3.3.2, "Impedance Parameters"](#), on page 49 and [Chapter 3.3.3, "Admittance Parameters"](#), on page 52).

Remote command:

[SENSe<Ch>:]CORRection:CONNECTION

**Line Type / Rel. Permittivity / Cutoff Frequency  $f_c$** 

"Line Type" describes the wave propagation mode (offset model) in the transmission lines of the standards associated with the connector type.

- If the calibration kit standards contain lines with transverse electric propagation mode (TEM, e.g. coax cables), then the "Relative Permittivity  $\epsilon_r$ " of the dielectric can be defined. The default permittivity is the value for air. TEM-type lines have no cutoff frequency.
- If the calibration kit standards contain waveguides, then the lowest frequency where a wave propagation is possible ("Cutoff Frequency  $f_c$ ") can be defined. The default cutoff frequency is 0 Hz (propagation at all frequencies). No relative permittivity is needed for waveguides.

**Note:** The impedance for waveguides is frequency-dependent. If a waveguide line type is selected, various dialogs (e.g. "Add Standard...") will indicate "varies" instead of a definite impedance value.

**Impact of line type parameters**

The line type parameters are used for the calculation of the S-parameters for the calibration standards associated with the connector type, provided that they are derived from a circuit model (see [Chapter 4.4.3.9, "View / Modify Cal Kit Standards Dialog"](#), on page 279).

- For TEM-type lines, the relative permittivity  $\epsilon_r$  is needed for the conversion of a ZVR-type "Loss" (in units of dB/sqrt(GHz)) into an Agilent-type "Offset Loss" (in units of  $G\Omega/s$ ) and vice versa (see [Chapter 4.4.3.9, "View / Modify Cal Kit Standards Dialog"](#), on page 279). The "Electrical Length" and "Delay" values in the "View / Modify Cal Kit Standards" dialog are directly entered and therefore independent of  $\epsilon_r$ .
- For waveguides, the low frequency cutoff frequency  $f_c$  is important because no wave propagation is possible at frequencies below  $f_c$ . If a standard is measured in order to acquire calibration data, the analyzer checks the low frequency cutoff. If the start frequency of the sweep range is below  $f_c$ , an error message is generated.

The offset model parameters are not used except in the context of calibration. The offset parameter definitions are based on independent  $\epsilon_r$  values; see [Chapter 4.4.6.2, "Offset Embed > Offset"](#), on page 311.

Remote command:

```
[SENSe<Ch>:]CORRection:CONNection
```

**Add / Delete**

Adds or deletes a user-defined connector type. The parameters of a user-defined connector type can be modified in the table. Deleting a connector type will also delete all calibration or adapter kits assigned to it.

Remote command:

```
[SENSe<Ch>:]CORRection:CONNection
[SENSe<Ch>:]CORRection:CONNection:CATalog?
[SENSe<Ch>:]CORRection:CONNection:DELeTe
```

#### 4.4.3.7 Calibration Kits Dialog

The "Calibration Kits" dialog shows the available calibration kits for the different connector types. It is also used for cal kit and cal kit file management.



#### Related information

Refer to the following sections:

- See also [Chapter 3.5.2, "Calibration Standards and Calibration Kits"](#), on page 85
- [Chapter 3.5.2.4, "Cal Kit Files"](#), on page 89
- [Chapter 3.5.2.2, "Cal Kit Parameter Types"](#), on page 87
- [Chapter 4.4.3.6, "Cal Connector Types Dialog"](#), on page 273

**Access:** CHANNEL > CAL > Calibration > Cal Kits ...



The contents of the "Available Cal Kits" table vary, depending on the selected "Connector Type". The table may also contain kits with ideal or typical parameter values; see [Cal Kit Parameter Types](#). The "Agilent Model" is an optional scheme to characterize the offset parameters of the standards; see ["Offset Parameters"](#) on page 280.



#### Cal kit labels

Assigning a label to user-defined calibration kits is optional. However, the label is displayed in many dialogs and can provide useful information about the kit, e.g. its serial number. It is even possible to assign several calibration kits with the same name, distinguished by their label, to a common connector type. See also [Chapter 6.3.15.5, "\[SENSE:\]CORrection:CKIT... with Labels"](#), on page 595.

#### Add / Copy / Delete / Standards...

The buttons in the right part of the dialog are used to manage calibration kits:

- "Add" creates a new cal kit file for the selected connector type.
- "Copy" creates a new cal kit file based on the contents of an existing cal kit file.
- "Delete" deletes an imported or user-defined cal kit file.

- "Standards..." opens the "Kit Standards" dialog. This dialog shows the contents of the cal kit file. For user-defined or imported kits, you can modify the contents. See [Chapter 4.4.3.8, "Kit Standards Dialog"](#), on page 277.

Remote command:

The following commands create and modify calibration kits:

```
[SENSe:]CORRection:CKIT:<ConnType>:SElect
[SENSe:]CORRection:CKIT:<ConnType>:LSElect
[SENSe:]CORRection:CKIT:DMODE
[SENSe:]CORRection:CKIT:DElete
```

Query connector types and calibration kits:

```
[SENSe<Ch>:]CORRection:CONNection:CATalog?
[SENSe:]CORRection:CKIT:CATalog?
```

### Import / Export

The buttons below the "Connector Type" list are used to store cal kit data to a file and to re-load previously stored cal kit files. By default, calibration kit files are stored in the C:\Users\Public\Documents\Rohde-Schwarz\Vna\Calibration directory; see [Chapter 3.5.2.4, "Cal Kit Files"](#), on page 89.

Remote command:

[MMEMory:LOAD:CKIT](#) on page 552

[MMEMory:STORe:CKIT](#) on page 566

#### 4.4.3.8 Kit Standards Dialog

The "Kit Standards" dialog shows the calibration standards in a selected calibration kit. It is also used to modify the contents of a user-defined kit.



#### Related information

Refer to the following sections:

- [Chapter 3.5.2.4, "Cal Kit Files"](#), on page 89
- [Chapter 4.4.3.7, "Calibration Kits Dialog"](#), on page 276
- [Chapter 3.5.2.1, "Calibration Standard Types"](#), on page 85

**Access:** CHANNEL > CAL > Calibration > Cal Kits ... > Standards ...

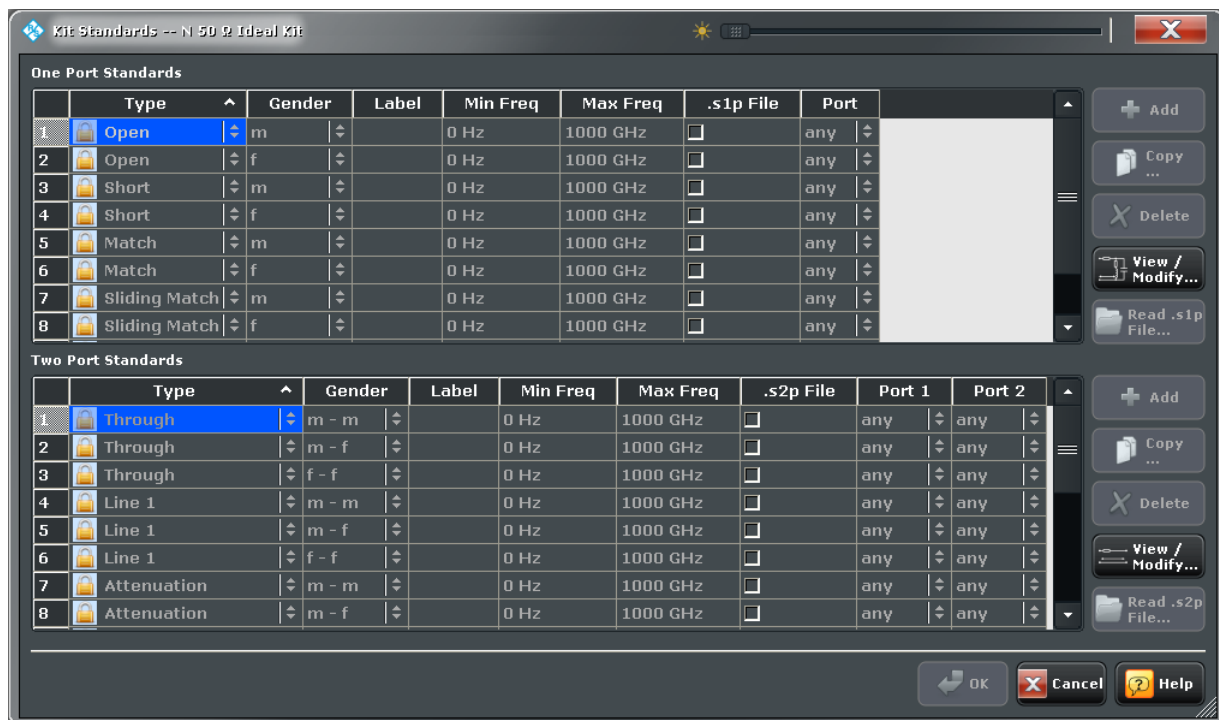

One port and two port standards are listed in two separate tables. Most of the buttons on the right side are available only if the "Kit Standards" dialog was opened for a user-defined calibration kit.

### Table Columns

The standard table contain the following information:

- "Type" and "Gender" describe the calibration standard type; for an overview see [Chapter 3.5.2.1, "Calibration Standard Types"](#), on page 85.
- "Label" is a user defined name of the standard. The label can help you identify a standard or distinguish different standards with similar parameters.
- "Min Freq" and "Max Freq" define the rated frequency range of the standard. During calibration, the analyzer checks whether the sweep range is within the validity range of all measured standards and possibly generates a warning.
- ".s1p File" and ".s2p File" define whether the characteristics of the standard are described by a Touchstone file rather than by a circuit model from which the R&S ZNC/ZND can calculate the S-parameters. See "[Read .s<n>p File...](#)" on page 279 and [Chapter 4.4.3.9, "View / Modify Cal Kit Standards Dialog"](#), on page 279.
- "Port" defines whether the standard can be connected to any analyzer port or to just one port (for one-port standards) or a pair of ports (for two-port standards). Standards with unrestricted port assignment ("any") are stored with their gender. When a connector type and calibration kit is selected for the calibration, the analyzer checks whether the kit contains the necessary standard types and whether the standards have the right gender.

Standards with restricted port assignment are always assumed to have the gender that is appropriate for the calibrated port. The **port assignment** is stored in the calibration kit file, instead of the gender. During the calibration, the analyzer checks whether the cal kit contains the necessary standard types for the required ports.

Remote command:

```
[SENSe:]CORRection:CKIT:<StandardType>  
[SENSe:]CORRection:CKIT:<ConnType>:SElect
```

#### Add / Copy / Delete / View / Modify...

The buttons in the right part of the dialog are used to manage standards:

- "Add" adds a new standard to the calibration kit. The properties of the standard can be edited in the table.
- "Copy" creates a new standard based on the properties of an existing standard.
- "Delete" deletes the selected standard.
- "View / Modify ..." opens the "View / Modify Cal Kit Standards" dialog. This dialog shows the circuit model for the selected standard. For user-defined standard, you can modify the circuit model parameters. See [Chapter 4.4.3.9, "View / Modify Cal Kit Standards Dialog"](#), on page 279.

Remote command:

```
[SENSe:]CORRection:CKIT:<StandardType>  
[SENSe:]CORRection:CKIT:<StandardType>:WLAbel
```

#### Read .s<n>p File...

Opens a file selection dialog where you can select a Touchstone file containing the reflection or transmission S-parameters for the standard. The R&S ZNC/ZND uses the imported S-parameters rather than the circuit model to characterize the standard, if ".s<n>p File" is checked in the standard table. The appropriate file type (\*.s1p for one-port standards and \*.s2p for two-port standards) is selected automatically.

Remote command:

```
[SENSe:]CORRection:CKIT:CATalog?
```

### 4.4.3.9 View / Modify Cal Kit Standards Dialog

The "View / Modify Cal Kit Standards" dialog shows the circuit model for a selected calibration standard. It is also used to define or edit the circuit model (offset and load) parameters for a user-defined standard.



#### Related information

Refer to the following sections:

- [Chapter 3.5.2.4, "Cal Kit Files"](#), on page 89
- [Chapter 4.4.3.8, "Kit Standards Dialog"](#), on page 277
- [Chapter 3.5.2.1, "Calibration Standard Types"](#), on page 85

---

**Access:** CHANNEL > CAL > Calibration > Cal Kits ... > Standards ... > View / Modify

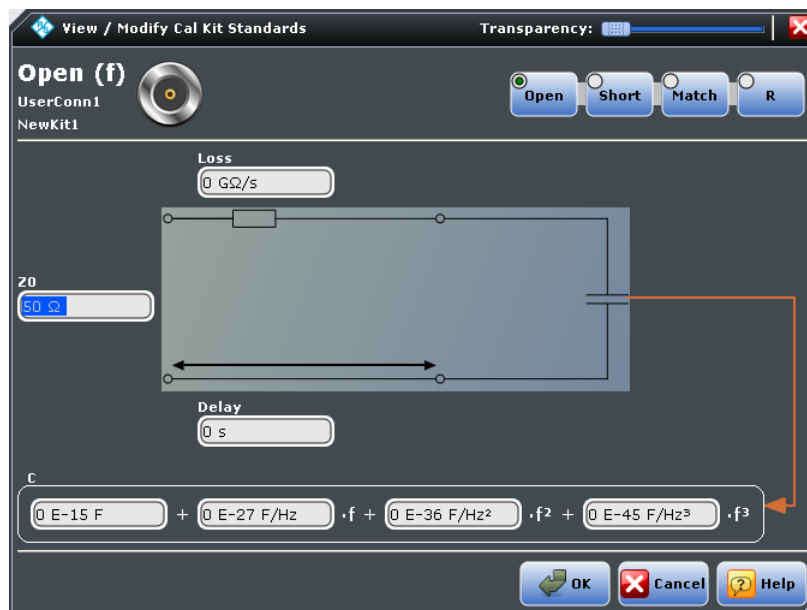

The diagram in the "View / Modify Cal Kit Standards" dialog depends on the standard type for which the dialog was opened. Moreover, it is possible to modify the circuit model using the buttons in the upper right of the dialog.

### Offset Parameters

The entries on the left-hand side specify the offset parameters for the transmission lines of the selected calibration standard.

The offset parameters depend on whether or not the circuit model is defined in "Agilent Mode" (see [Chapter 4.4.3.6, "Cal Connector Types Dialog"](#), on page 273):

- If "Agilent Mode" is active, then the standard is characterized by its "Delay" (in s), its characteristic impedance  $Z_0$  (in  $\Omega$ ) and its "Offset Loss" (in  $G\Omega/s$ ).
- If "Agilent Mode" is switched off, then the standard is characterized by the R&S ZVR-compatible parameters "Electrical Length" (in m), its "Char. Impedance" (in  $\Omega$ ) and its "Loss" (in  $dB/\sqrt{GHz}$ ). The loss is zero and not editable as long as the electrical length is zero.

Both parameter sets are closely related. The "Electrical Length" is proportional to the "Delay";  $Z_0$  corresponds to the "Char. Impedance". Moreover the analyzer converts an Agilent-type "Offset Loss" into a ZVR-type Loss and vice versa using the "Relative Permittivity"  $\epsilon_r$  for the selected connector type.

See also description of the offset parameters in [Chapter 3.5.2.1, "Calibration Standard Types"](#), on page 85.

Remote command:

```
[SENSe:]CORRection:CKIT:<StandardType>
```

### Load Parameters

The entries on the right-hand side or across the bottom of the "View / Modify Cal Kit Standards" dialog specify the load parameters for a particular calibration standard describing its terminal impedance.



The circuit model for the load consists of capacitance C which is connected in parallel to an inductance L and a resistance R, both connected in series.

- "R" is the constant resistive contribution. It is possible to select a special value ("Open" for  $\infty \Omega$  so that the inductance coefficients are irrelevant, "Short" for  $0 \Omega$ , Match for the reference impedance of the current connector type) or set any resistance R.
- The fringing capacitance C and the residual inductance L are both assumed to be frequency-dependent and approximated by the first four terms of the Taylor series around  $f = 0$  Hz.

See also description of the load parameters for the different standard types in [Chapter 3.5.2.1, "Calibration Standard Types"](#), on page 85.

Remote command:

```
[SENSe:]CORRection:CKIT:<StandardType>
```

#### 4.4.3.10 Characterize Cal Unit Dialog

The "Characterize Cal Unit" dialog displays the properties of the connected cal units, provides control elements for characterization file management, and starts the characterization wizard.



##### Background information

Refer to [Chapter 3.5.5.3, "Characterization of Calibration Units"](#), on page 96.

---



A cal unit characterization can be performed in a frequency sweep. The "Characterize Cal Unit" dialog is unavailable while a power, CW Mode, or time sweep is active. The analyzer always uses a fixed source power of  $-10$  dBm to acquire the characterization data.

---

**Access:** CHANNEL > CAL > Cal Devices > Characterize Cal Unit...

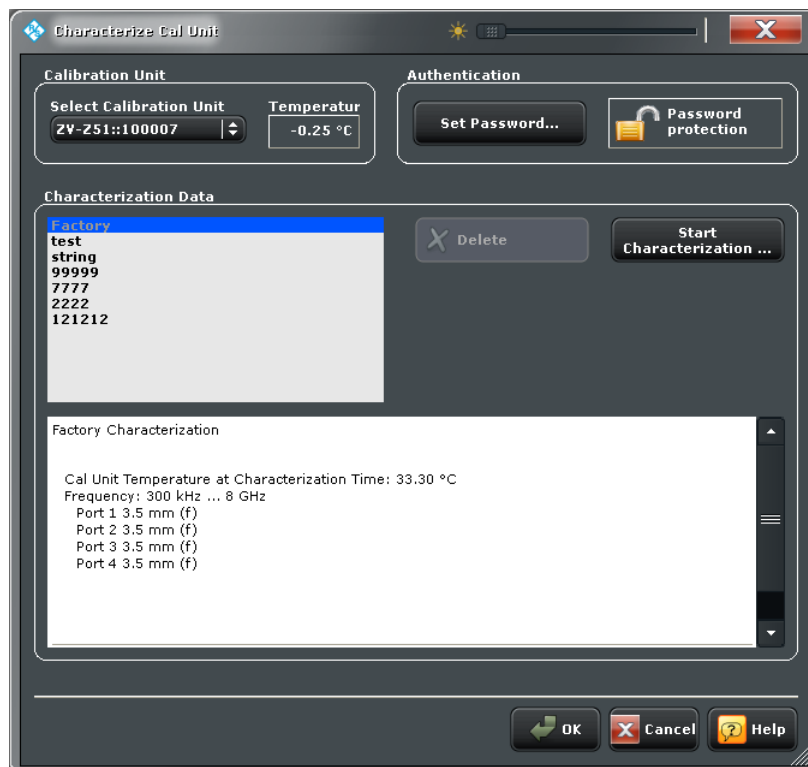

### Calibration Unit

Displays the connected calibration units. The R&S ZNC/ZND auto-detects all calibration units which are connected to one of its USB ports. If several cal units are connected, one of them must be selected for characterization (active cal unit).

Remote command:

`SYSTem:COMMunicate:RDEvice:AKAL:ADDRess:ALL?`

`SYSTem:COMMunicate:RDEvice:AKAL:ADDRess`

### Authentication / Set Password

Set a password to protect the characterization dialog and the "Start Characterization" wizard from unauthorized access and operation. "Set Password" opens a dialog to enter the password and activate password protection at the next time the "Characterize Cal Unit" dialog is opened. Enter an empty string (no password) to deactivate password protection.

**Tip:** A password also blocks a switchover of the active characterization during calibration; see "Characterization" on page 256.

Remote command:

`[SENSe:]CORRection:COLLect:AUTO:CKIT:PASSword`

### Characterization Data

Displays all characterizations which are stored on the active cal unit. The "Factory" characterization is available for all calibration units; it ensures an accurate calibration for all standard applications. Characterizations stored on an SD card (inserted at the cal unit) are prefixed with "SD:".

**Tip:** Characterizations stored on an SD card (inserted at the cal unit) are prefixed with "SD:".

The properties of the selected characterization are shown below the list. "Delete" deletes the selected characterization file; "Start Characterization" opens the [Characterization Wizard](#) to create a new characterization.

Remote command:

```
SYSTem:COMMunicate:RDEvice:AKAL:CKIT:CATalog?
```

```
SYSTem:COMMunicate:RDEvice:AKAL:CKIT:STANdard:CATalog?
```

```
SYSTem:COMMunicate:RDEvice:AKAL:SDATa?
```

#### 4.4.3.11 Characterization Wizard

The "Characterization" wizard guides you through the automatic characterization of a calibration unit.

The guided characterization consists of the following steps:

1. **Characterization:** Select the characterized ports and cal unit standards and initiate the characterization sweeps.
2. **Save Characterization Data:** Save the characterization data to an internal file on the calibration unit.

##### Step 1: Characterization

Selects the calibration type as well as the characterized cal unit ports and initiates the necessary characterization sweeps.



##### Characterization procedure

To acquire accurate characterization data, the test setup must be properly calibrated before you start the characterization wizard. Use the calibration type that you wish to perform with your new cal unit characterization; see [Chapter 3.5.5.3, "Characterization of Calibration Units"](#), on page 96.

---

**Access:** CHANNEL > CAL > Cal Devices > Characterize Cal Unit... > Start Characterization...



### Test Port Assignment

Defines the assignment between test ports and cal unit ports. In the default "Manual" assignment, VNA ports and cal unit port numbers match. If you decide to use a different assignment, you can auto-detect the actual assignment ("Automatic") or select the analyzer port numbers manually. Auto-detection may fail e.g. because of a high attenuation in the signal path.

Remote command:

```
[SENSe<Ch>:]CORRection:COLLect:AUTO
[SENSe<Ch>:]CORRection:COLLect:AUTO:PORTs
[SENSe:]CORRection:COLLect:AUTO:PORTs:CONNection?
[SENSe:]CORRection:COLLect:AUTO:CKIT:PORTs
```

### Take OSM ... / Take All OSM and Through

Starts a calibration sweep for the selected port(s). "Take All OSM and Through" initiates a series of calibration sweeps; the R&S ZNC/ZND acquires a full set of one-port and two-port data. This is required for the transmission normalizations and for a "One Path Two Ports" calibration; see "[Dependency between calibration types and characterization data](#)" on page 96.

Remote command:

```
[SENSe<Ch>:]CORRection:COLLect:AUTO
[SENSe<Ch>:]CORRection:COLLect:AUTO:PORTs
[SENSe:]CORRection:COLLect:AUTO:PORTs:CONNection?
```

### Next

Proceeds to the second dialog in the characterization wizard ("Save Characterization Data"). Next is available as soon as the R&S ZNC/ZND has acquired characterization data for a single port.

## Step 2: Save Characterization Data

Saves the characterization data to the calibration unit.

**Access:** CHANNEL > CAL > Cal Devices > Characterize Cal Unit... > Start Characterization...

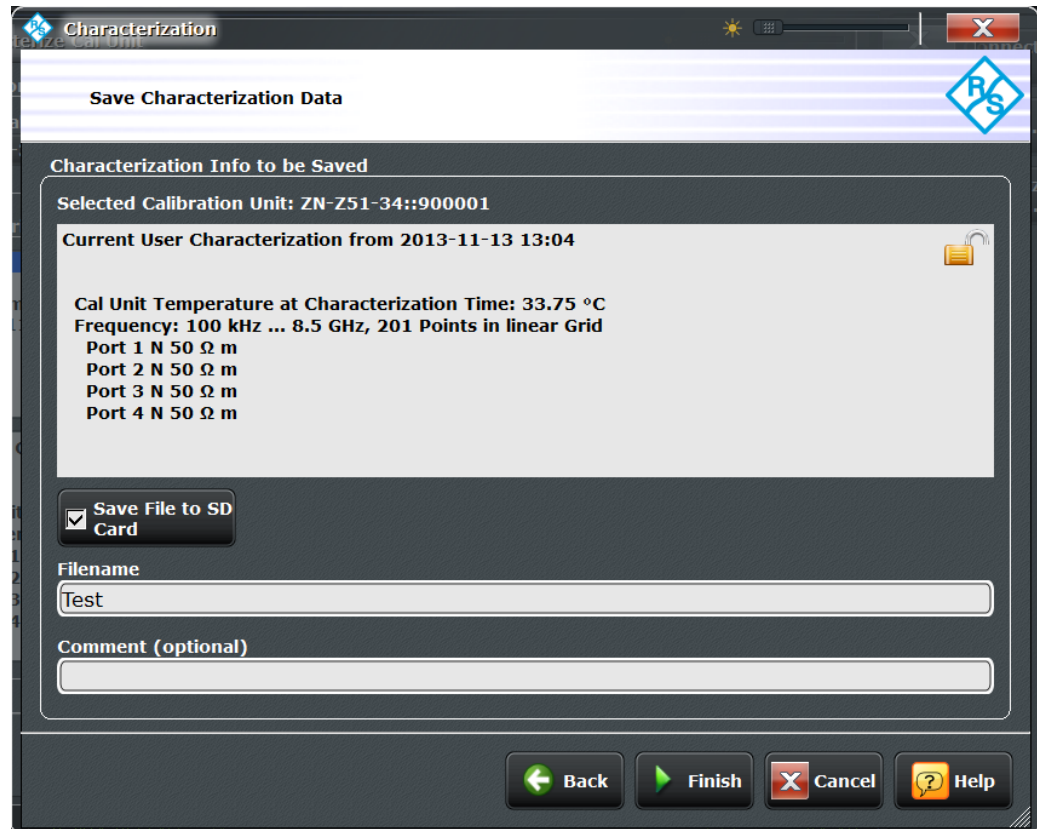

Figure 4-8: Save Characterization Data

### Save File to SD Card

For some calibration units (e.g. the new models R&S ZN-Z5x and -Z15x), characterization data can either be saved to the calibration unit's internal flash memory or to an SD card inserted at the calibration unit. Activate this checkbox to save the characterization data to the SD card.

**Tip:** If the characterized CalUnit doesn't have an SD card slot, the checkbox is hidden. If the CalUnit has an SD card slot but the SD card isn't accessible, the checkbox is greyed out.

### Filename / Comment

Selects a file name to reference the characterization data set in the "Characterize Cal Unit" and "Calibration Unit" dialogs and a comment, to be written into the characterization file. A file name is required before you can "Finish" the characterization wizard and store the data.

Remote command:

```
[SENSe:]CORRection:COLLect:AUTO:CKIT
```

#### 4.4.3.12 Calibration > Pwr Cal Settings

Provides access to all functions for power meter and power calibration data handling (transmission coefficients). Power calibration of the R&S ZNC/ZND is a fully menu-guided process.



##### Efficient power calibration procedure

- For standard applications, open the "Start Cal" tab and select "Scalar Power Cal > Power Cal..." to perform the necessary calibration sweeps with default power calibration settings. You do not need any of the buttons in the "Pwr Cal Settings" tab.
- Select "Cal Power ..." if you use an amplifier between the source port and the DUT.
- Select "Transmission Coefficients ..." if you want to modify the power calibration procedure.



##### Background information

Refer to [Chapter 3.5.6, "Scalar Power Calibration"](#), on page 97.

**Access:** CHANNEL > CAL key or Alt + Shift + P



The "Calibration" buttons open the following dialogs:

- **Cal Power...:** See [Chapter 4.4.3.13, "Modify Cal Power Dialog"](#), on page 288
- **Transmission Coefficients...:** See [Chapter 4.4.3.14, "Power Meter Transmission Coefficients Dialog"](#), on page 290
- **Power Meters...:** See [Chapter 3.7.11, "External Power Meters"](#), on page 117

**Switch Off All Other Sources**

Ensures that the power at all sources except the calibrated source is switched off during the calibration. This is advisable especially if the measurement involves a combination of different signals.

Remote command:

```
SOURce<Ch>:POWer<PhyPt>:CORRection:OSources[:STATe]
```

**Flatness Cal > Total Readings**

Sets a limit for the number of calibration sweeps. See also ["Calibration procedure"](#) on page 98.

Remote command:

```
SOURce<Ch>:POWer<PhyPt>:CORRection:NREadings  
SOURce<Ch>:POWer<PhyPt>:CORRection:COLLect:AVERage[:COUNT]
```

**Flatness Cal > Tolerance**

Defines the maximum deviation of the measured power from the cal power. The calibration procedure is stopped if the number of "Total Readings" is reached or if the measured power is within the "Tolerance".

Remote command:

```
SOURce<Ch>:POWer<PhyPt>:CORRection:COLLect:AVERage:NTOLerance
```

**Flatness Cal > Convergence**

Modifies the amount of power correction for each of the flatness calibration sweeps. The power correction in each sweep, as controlled by the calibrated reference receiver (a-wave receiver), is multiplied by the selected convergence factor. With a convergence factor larger (smaller) than 1, the source power correction after each flatness calibration step is larger (smaller) than the measured deviation from the desired power.

For analyzer test ports, a convergence factor 1 is appropriate. Convergence factors different from 1 may be indicated for external generator ports which show a nonlinear behavior. In general, it is recommendable to start the calibration with a convergence factor 1 and choose smaller values (0.8 ... 0.4) in case that the iteration fails. Inappropriate convergence factors can slow down the flatness calibration or even prevent convergence.

Remote command:

```
SOURce<Ch>:POWer<PhyPt>:CORRection:COLLect:CFACTOR
```

**Power Meter**

Shows a list of all power meters that have been properly configured and are available for the power calibration of a source port. The last configured power meter is selected by default. See ["Configured Devices"](#) on page 352.

Remote command:

```
SOURce:POWer:CORRection:PMETer:ID
```

**Auto Zero**

Initiates an automatic zeroing procedure of the power meter; see ["Zeroing"](#) on page 118.

Remote command:

`SYSTEM:COMMunicate:RDEVICE:PMETER<Pmtr>:AZERO`

#### 4.4.3.13 Modify Cal Power Dialog

The "Modify Cal Power" dialog adjusts the target power for the power calibration (cal power), in particular for test setups with external attenuators or amplifiers, and defines the target power for the reference receiver calibration.

The diagram in the center of the dialog visualizes the settings and results below.

**Access:** CHANNEL > CAL > Pwr Cal Settings > Cal Power...

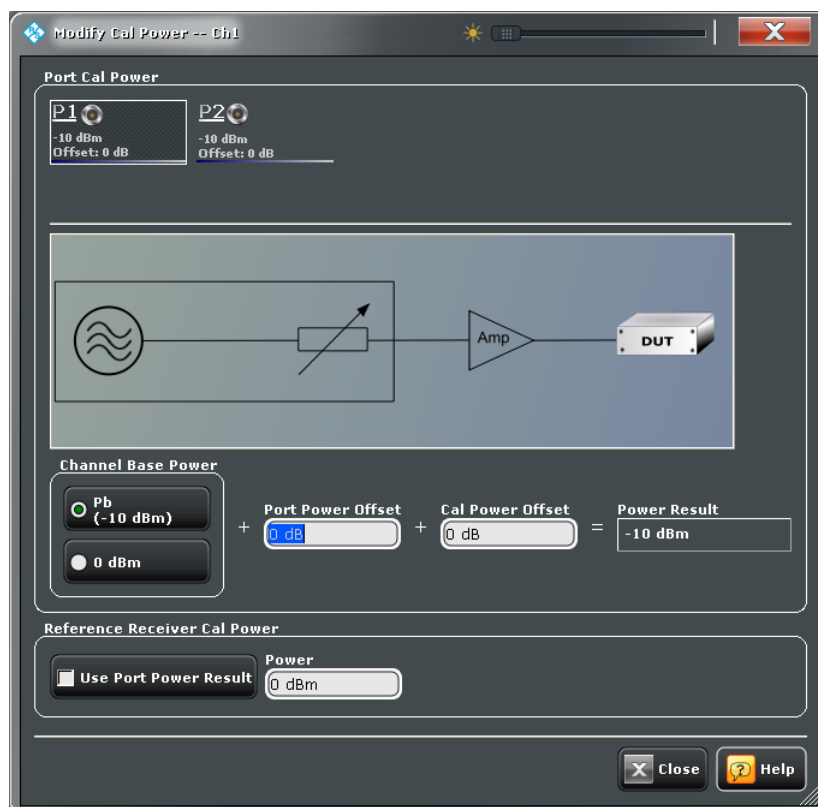

#### Port Overview

The dialog shows all source ports of the network analyzer. Each port is displayed with the current "Power Result" at the input of the DUT (in dBm) and offset (i.e. the "Cal Power Offset" in dB).

Remote command:

`SOURCE<Ch>:POWER<PhyPt>[:LEVEL][:IMMEDIATE]:OFFSET`

`SOURCE<Ch>:POWER<PhyPt>:CORRECTION:LEVEL:OFFSET`



**Port Power Offset**

Defines a port-specific offset to the channel base power. The actual output power at the port is equal to the channel base power  $P_b$  ("CHANNEL > POWER BW AVG > Power > ...") plus the "Port Power Offset". It is equal to the "Port Power Offset" (converted into dBm) if "0 dBm" is selected instead of  $P_b$ .

For power sweep and the selection  $P_b$ , the actual port power varies across the sweep; for other configurations the port power is constant.

Remote command:

```
SOURce<Ch>:POWer<PhyPt>[:LEVel][:IMMediate]:OFFSet
```

**Cal Power Offset**

For power calibrations only: Specifies a gain (positive values) or an attenuation (negative values) in the signal path between the source port and the calibrated reference plane. With a "Cal Power Offset" of  $n$  dB, the target power at the reference plane (cal power) is equal to the actual output power at the port plus  $n$  dB. The "Cal Power Offset" has no impact on the source power.

**Example: Use of an amplifier in the signal path**

Assume that a DUT requires a constant input power of +25 dBm, and that the measurement path contains an amplifier with a 30 dB gain. After a reset of the analyzer the channel power  $P_b$  is -10 dBm. With a "Port Power Offset" of +5 dB at the calibrated source port and a "Cal Power Offset" of +30 dB, the source power calibration ensures that the constant input power of +25 dBm is maintained across the entire sweep range. The actual output power of the analyzer is -5 dBm.

Notice that a power calibration with an appropriate "Cal Power Offset" will automatically prevent excess input levels at the DUT.

Remote command:

```
SOURce<Ch>:POWer<PhyPt>:CORRection:LEVel:OFFSet
```

**Reference Receiver Cal Power**

Defines the source power which the R&S ZNC/ZND uses to perform the first calibration sweep of the source power calibration. In this first sweep, the power meter reading is used to calibrate the reference receiver of the calibrated port; the following calibration sweeps are based solely on the reference receiver (see "Calibration procedure" on page 99).

The accuracy of the source power calibration depends on the the power meter's measurement accuracy, therefore it is advantageous to select a reference receiver cal power at which the power meter provides a maximum accuracy. Otherwise your can use equal port cal power and reference receiver cal power values.

**Note: Risk of damage due to high power settings**

If an external device (e.g. an amplifier) is connected between the calibrated test port and the power meter, ensure that the reference receiver cal power does not exceed the maximum input power of this device.

Remote command:

```
SOURce<Ch>:POWer<PhyPt>:CORRection:PPOWer
SOURce<Ch>:POWer<PhyPt>:CORRection:PSElect
```

#### 4.4.3.14 Power Meter Transmission Coefficients Dialog

The "Power Meter Transmission Coefficients" dialog allows you to modify the scalar power calibration data in order to account for an additional two-port device in the test setup with known transmission coefficients. Configuration of the transmission coefficients and activation are independent from each other.



#### Background information

Refer to [Chapter 3.5.6.4, "Extended Test Setups"](#), on page 101.

**Access:** CHANNEL > CAL > Pwr Cal Settings > Transm. Coefficients...

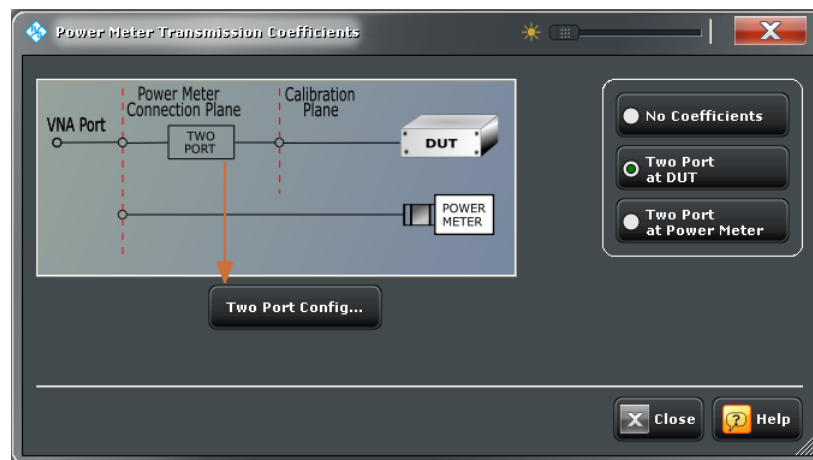

#### Test Setup

Selects a test setup with an additional two port in front of the DUT (during the measurement) or in front of the power meter (during power calibration). "No Coefficients" disables the transmission coefficients but does not delete the entries in the "Two Port Configuration" dialog.

Remote command:

```
SOURce<Ch>:POWer<PhyPt>:CORRection:TCoefficient[:STATE]
SOURce<Ch>:POWer<PhyPt>:CORRection:TCoefficient:CALibration
```

#### Two Port Config...

Opens the "Two Port Configuration" dialog to define transmission coefficients for the "Two Port at DUT" and the "Two Port at Power Meter" test setups. The button is disabled if "No Coefficients" is active. See [Chapter 4.4.3.15, "Two Port Configuration Dialog"](#), on page 290.

#### 4.4.3.15 Two Port Configuration Dialog

The "Two Port Configuration" dialog defines the transmission characteristics of an additional two-port in the calibrated frequency range.

**Access:** CHANNEL > CAL > Pwr Cal Settings > Transm. Coefficients... > Two Port Config...

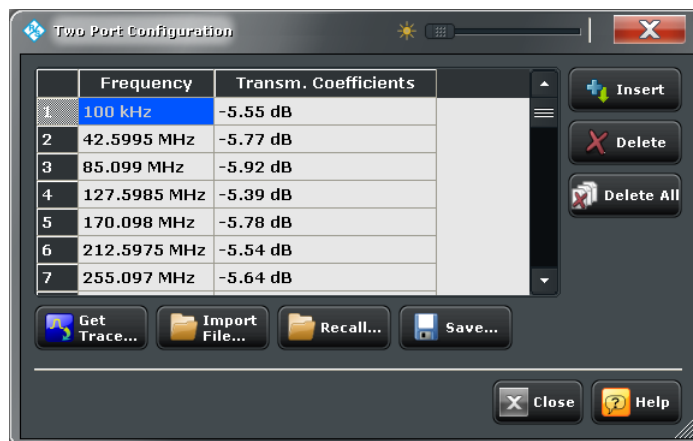

### Transmission Coefficients; Insert / Delete / Delete All

The required two-port information is a list of transmission coefficients at different frequency values (power loss list). The buttons in the dialog provide different ways of creating and modifying the list. Use "Insert", "Delete", "Delete All" to edit the list manually.

In a power, time or CW mode sweep, one point at the fixed CW frequency is sufficient. In a frequency sweep it is possible to enter several coefficients to account for a frequency-dependent attenuation. Transmission coefficients are interpolated between the frequency points and extrapolated, if necessary. If no transmission coefficient is defined at all, the R&S ZNC/ZND assumes a 0 dB attenuation across the entire frequency range, which is equivalent to an ideal through connection or no "No Coefficients".

Remote command:

```
SOURce<Ch>:POWer<PhyPt>:CORRection:TCoefficient:INSert<ListNo>
SOURce<Ch>:POWer<PhyPt>:CORRection:TCoefficient:DEFine<ListNo>
SOURce<Ch>:POWer<PhyPt>:CORRection:TCoefficient:COUNT?
SOURce<Ch>:POWer<PhyPt>:CORRection:TCoefficient:DELEte<ListNo>[:
DUMMy]
SOURce<Ch>:POWer<PhyPt>:CORRection:TCoefficient:DELEte<ListNo>:
ALL
```

### Get Trace...

Opens a selection box containing all traces in the active recall set. The "dB Mag" values of the selected trace are used to define the transmission coefficients. Notice that if you combine different channels with different sweep points, the analyzer may have to interpolate or extrapolate the transmission coefficients.

Remote command:

```
SOURce<Ch>:POWer<PhyPt>:CORRection:TCoefficient:FEED
```

### Import File...

Imports the transmission coefficients from a trace file. The imported file must be either in Touchstone (\*.s<n>p) or in \*.csv format; see also [Chapter 3.4.2, "Trace Files"](#), on page 68.

Remote command:

```
MMEMoRY:LOAD:CORRection:TCoefficient
```

**Recall... / Save...**

You can save the displayed power loss list to a power meter correction list file with extension (\*.pmc1) and re-load it in later sessions.

Remote command:

MMEMory:LOAD:CORRection:TCoefficient

MMEMory:STORe:CORRection:TCoefficient

**4.4.3.16 Calibration > Use Cal**

Provides access to all functions for automatic or manual calibration and for calibration kit management. Calibration is a fully menu-guided process.

**Background information**

Refer to the following sections:

- [Chapter 3.5, "Calibration"](#), on page 73

**Access:** CHANNEL > CAL key or Alt + Shift + P



The "Use Cal" buttons open the following dialogs:

- **Active Power Cals...:** See [Chapter 4.4.3.17, "Active Power Cals Dialog"](#), on page 293
- **Cal Manager...:** See [Chapter 4.4.3.18, "Calibration Manager Dialog"](#), on page 294

**User Cal Active**

Activates or deactivates the system error correction in the active channel. "User Cal Active" is available only if a valid system error correction is available for the active channel; see "Channel State" in [Chapter 4.4.3.18, "Calibration Manager Dialog"](#), on page 294.

**Note:** A label "Cal Off" appears behind the trace list if the system error correction is switched off; see also [Chapter 3.5.4, "Calibration Labels"](#), on page 91. The calibration status of each channel and trace appears in the setup information ("SYSTEM > SETUP > Info... > Setup").

Remote command:

[SENSe<Ch>:]CORRection[:STATe]

#### All Power Cals On / Off

Activates or deactivates all scalar power calibrations in the active channel. "All Power Cals On" is available only if a valid power calibration is available for the active channel, but not active; see "Channel State" in [Chapter 4.4.3.18, "Calibration Manager Dialog"](#), on page 294.

**Note:** A label "PCal Off" appears behind the trace list of a wave quantity or a ratio if the power calibration is switched off; see also [Chapter 3.5.6.3, "Power Calibration Labels"](#), on page 100. The calibration status of each channel and trace appears in the setup information ("SYSTEM > SETUP > Info... > Setup").

Remote command:

[SENSe<Ch>:]CORRection:PCAL

#### Recall Last Cal Set

Loads and activates the recall set for which the last calibration was performed. If the last calibrated setup is already active, nothing is changed. The calibrated setups are automatically stored in the

C:\Users\Public\Documents\Rohde-Schwarz\Vna\Calibration\RecallSets directory. A message box pops up if the directory is empty, e.g. because no calibration was performed yet.

Remote command:

n/a

### 4.4.3.17 Active Power Cals Dialog

The "Active Power Cals" dialog shows the power calibrations for the active channel, enables and disables power calibrations.

**Access:** CHANNEL > CAL > Power Cal > Active Power Cals...



#### Port Overview

Shows all source ports together with the possible power calibrations. Either a source power calibration ("Power") or a measurement receiver calibration ("Meas. Receiver") can be performed at each analyzer port P1 ... PN.

**Note:** For a unidirectional R&S ZND (see [Chapter 3.1.4.2, "R&S ZND: Unidirectional vs. Bidirectional Operation"](#), on page 16) P2 cannot serve as source port. Hence only a calibration of the measurement receiver can be performed at P2.

Power calibrations can be enabled or disabled after the necessary calibration data has been acquired; see [Chapter 4.4.3.4, "Power Cal Screen"](#), on page 268.

Remote command:

```
SOURce<Ch>:POWer<PhyPt>:CORRection:STATe
[SENSe<Ch>:]CORRection:POWer<PhyPt>[:STATe]
[SENSe<Ch>:]CORRection:PCAL
```

#### 4.4.3.18 Calibration Manager Dialog

The "Calibration Manager" dialog stores user correction data to the cal pool and assigns stored correction data to channels.

See [Chapter 3.5.3, "Calibration Pool"](#), on page 91 for background information.

**Access:** CHANNEL > CAL > Calibration > Cal Manager ...

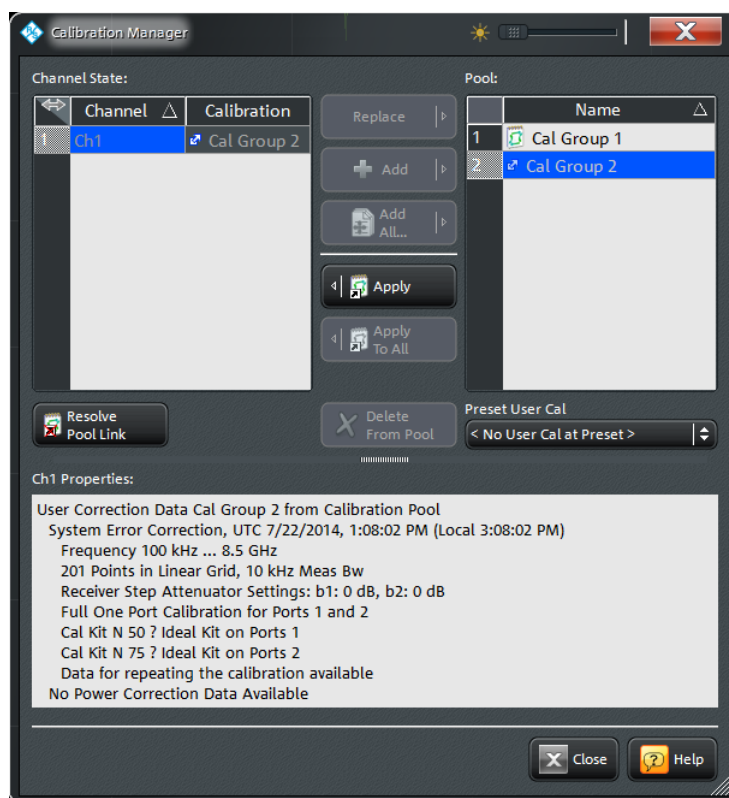

Drag the vertical divider (the horizontal bar below the "Delete from Pool" button) to specify how much of the dialog height goes to the upper and lower parts.

A warning appears before a calibration in the pool is overwritten by the new calibration. To continue the calibration confirm by using button "Overwrite current File?" or "Resolve Pool Link" on page 296.

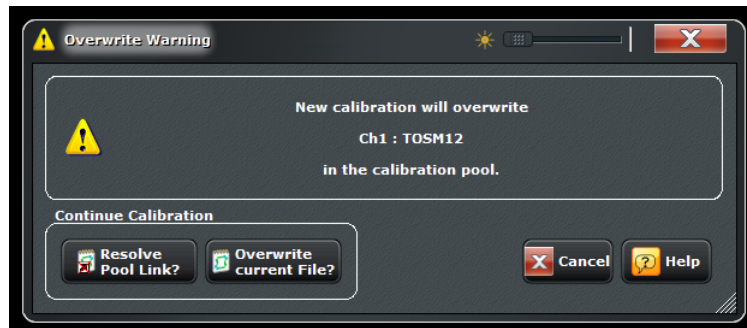

### Channel State

The "Channel State" table shows all channels in the active recall set together with their current calibration. Channels can use either the active channel calibration (if available), a previously stored user correction data or the factory system error correction (indicated as '--').

**Note:** If a new calibration is performed for a channel assigned to a cal group (marked as "<CalGroup>"), the correction data overwrites the cal group data, so the new calibration will affect all channels assigned to the cal group.

Remote command:

n/a

### Add / Add All / Replace / Apply / Apply to All

The buttons between the tables are used to modify the calibration pool and apply calibration data sets (cal groups) to channels:

- "Add" copies the correction data of the selected channel to the cal pool, generating a new pool member (cal group).
- "Add All" copies the correction data of all channels to the cal pool, generating new pool members (cal groups).
- "Replace" overwrites a cal group with new correction data.
- "Apply" assigns the selected cal group to the selected channel.
- "Apply to All" assigns the selected cal group to all channels in the "Channel State" table.

Remote command:

[MMEMemory:STORe:CORRection](#)

[MMEMemory:LOAD:CORRection](#)

[MMEMemory:LOAD:CORRection:MERGe](#)

### Pool / Delete from Pool

The "Pool" table shows all correction data sets <CalGroup\_name>.cal in the directory C:\Users\Public\Documents\Rohde-Schwarz\Vna\Calibration\Data. The name of a pool data set can be modified directly in the corresponding table cell.

"Delete from Pool" deletes a cal group file from the pool. **Note** however, that calibrations being used in any of the opened Recall Sets cannot be deleted!

Remote command:

`MMEMory:DELeTe:CORRection`

#### **Preset User Cal**

Selects a calibration from the pool that shall be restored during a user-defined preset.

Remote command:

`SYSTem:PRESet:USER:CAL`

#### **Resolve Pool Link**

Deletes the link between the selected channel <Channel> and the cal group <Cal Group>. The cal group data continues to be used as a channel calibration ("Channel Cal") for the "<Channel>", the "Channel State" list displays "<Channel> ... Channel Cal".

Remote command:

`MMEMory:LOAD:CORRection:RESolve`

#### **Channel Properties**

Displays the basic channel settings and the properties of the system error correction for the selected channel in the "Channel State" table.

In addition it is stated whether or not sweep data are available for the selected calibration.

Remote command:

`[SENSe<Ch>:]CORRection:DATE?`

`[SENSe<Ch>:]CORRection:DATA:PARAmeter<Sfk>?`

`[SENSe<Chn>:]CORRection:SState?`

### **4.4.4 Channel Config**

The "Channel Config" functions select, create and delete channels and optimize the measurement process.

#### **4.4.4.1 Channel Config > Channels**

Creates and deletes channels and selects a channel as the active channel.



You can monitor the channel activity using the `OUTPut<Ch>:UPORt[:VALue]` command and the output signals at pins 8 to 11 of the "USER PORT" connector.

---



#### **Background information**

Refer to [Chapter 3.1.3.3, "Active and Inactive Traces and Channels"](#), on page 14.

---

**Access:** CHANNEL > CHANNEL CONFIG key or Alt + Shift + O



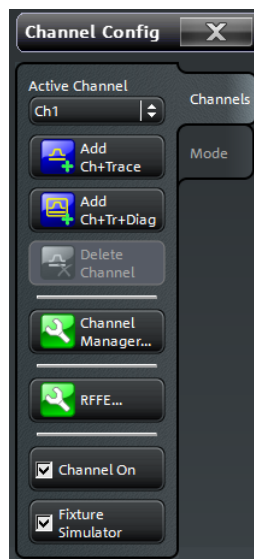

The buttons in the Channels tab open the following dialogs:

- **Channel Manager...**: see [Chapter 4.4.4.2, "Channel Manager Dialog"](#), on page 299

### Active Channel

Selects an arbitrary channel of the active recall set as the active channel. This function is disabled if the current recall set contains only one channel.

If one or several traces are assigned to the selected channel, one of these traces becomes the active trace.

The order of all channels in a recall set is given by the channels' creation time. By default, the channels are named Ch1, Ch2, ... so that Ch<n – 1> precedes Ch<n>. This order is always maintained, even if channels are renamed, invisible (because no traces are assigned to them) or distributed over several diagram areas.

**Tip:** You can simply tap a line in the channel list to activate the corresponding channel.

Remote command:

The numeric suffix <Ch> appended to the first-level mnemonic of a command selects a channel as the active channel.

### Add Ch + Trace

Creates a new channel and a new trace, which is displayed in the active diagram area. The new channel settings (including a possible channel calibration) are identical to the previous channel settings; the trace is created with the trace settings of the former active trace but displayed with another color. The former and the new active trace are superimposed but can be easily separated, e.g. by changing the "Reference Position".

The new channel is named Ch<n>, where <n> is the largest of all existing channel numbers plus one. The name can be changed in the "Channel Manager" dialog.

**Tips:** To create a new trace in the active channel, use "TRACE > TRACE CONFIG > Traces > Add Trace". To create a new channel and a new trace and display it in a new diagram area, use "Add Ch + Tr + Diag".

Remote command:

```
CONFigure:CHANnel<Ch>[:STATe] ON
CALCulate<Ch>:PARAmeter:SDEFine
DISPlay[:WINDow<Wnd>]:TRACe<WndTr>:FEED
CONFigure:TRACe<Trc>:CHANnel:NAME?
CONFigure:TRACe<Trc>:CHANnel:NAME:ID?
```

### Add Ch + Tr + Dia

Creates a new channel and a new trace, which is displayed in a new diagram area. The new channel settings (including a possible channel calibration) are identical to the previous channel settings; the trace is created with the trace settings of the former active trace but displayed with another color.

The new channel is named Ch<n>, where <n> is the largest of all existing channel numbers plus one. The name can be changed in the "Channel Manager" dialog.

**Tips:** To create a new trace in the active channel, use "TRACE > TRACE CONFIG > Traces > Add Trace". To create a new channel and a new trace and display it in the active diagram area, use "Add Ch + Trace".

Remote command:

```
CONFigure:CHANnel<Ch>[:STATe] ON
CALCulate<Ch>:PARAmeter:SDEFine
DISPlay[:WINDow<Wnd>][:STATe] ON
DISPlay[:WINDow<Wnd>]:TRACe<WndTr>:FEED
```

### Delete Channel

Deletes the current channel including all traces assigned to the channel and removes all display elements related to the channel from the diagram area. "Delete Channel" is disabled if the recall set contains only one channel: In manual control, each recall set must contain at least one diagram area with one channel and one trace.

**Tips:** Use the "Undo" function to restore a channel that was unintentionally deleted.

Remote command:

```
CONFigure:CHANnel<Ch>[:STATe] OFF
```

### Channel On

Toggles the measurement state of the [Active Channel](#).

Remote command:

```
CONFigure:CHANnel<Ch>:MEASure[:STATe]
```

### Fixture Simulator

When "Fixture Simulator" is **deactivated**

- all balanced ports are resolved to single ended ports
- all port impedances are set to default

At the GUI the "Balanced Ports" dialog is no longer accessible (the opener icons is deactivated); related remote commands will fail.

When "Fixture Simulator" is **reactivated**, the situation before the deactivation is restored.

**Note:** The "Offset" and "One Way Loss" settings are **not** affected by the "Fixture Simulation" switch. Use the All Compensation Off/On functions of the Fixture Compensation

dialog to de/activate these compensation as well (see "Fixture Compensation" on page 314).

Remote command:

```
CALCulate<Ch>:TRANSform:VNETworks:FSIMulator[:STATe]
```

#### 4.4.4.2 Channel Manager Dialog

The "Channel Manager" dialog provides convenient access to certain actions of the "CHANNEL > CHANNEL CONFIG > Channels" tab, allows to rename channels and to toggle single sweep mode.



#### Background information

Refer to [Chapter 3.1.3.3, "Active and Inactive Traces and Channels"](#), on page 14.

**Access:** CHANNEL > CHANNEL CONFIG > Channels > Channel Manager...

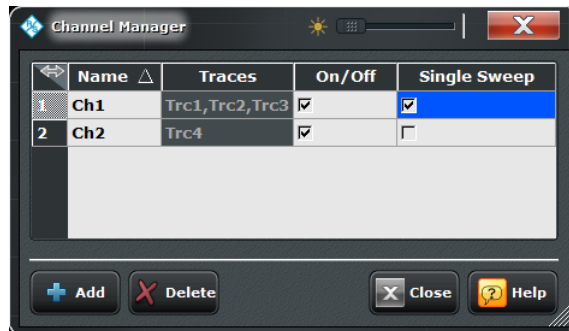

#### Channel table

The rows and columns of the channel table represent the existing channels (rows) together with certain editable (white) or non-editable (gray) properties (columns).

- "Name" indicates the name of the related channel.
- "Traces" indicates the names of all traces assigned to the related channel.
- "On/Off" toggles the measurement state of the related channel.
- "Single Sweep" toggles between single sweep and continuous mode.

Remote command:

```
CONFigure:CHANnel:CATalog?
```

```
CONFigure:CHANnel<Ch>:NAME
```

```
CONFigure:CHANnel<Ch>:NAME:ID?
```

```
CONFigure:CHANnel<Ch>:MEASure[:STATe]
```

```
INITiate<Ch>:CONTinuous
```

#### Add / Delete

The buttons below the channel table add and delete channels.

- "Add" adds a new channel to the list. The new channel is named Ch<n>, where <n> is the largest of all existing channel numbers plus one.
- "Delete" deletes the channel selected in the table. This button is disabled if the setup contains only one channel: In manual control, each setup must contain at least one diagram area with one channel and one trace.

Remote command:

CONFigure:CHANnel<Ch>[:STATe]

#### 4.4.4.3 Channel Config > Mode

Optimizes the measurement process.

**Access:** CHANNEL > CHANNEL CONFIG key or Alt + Shift + O

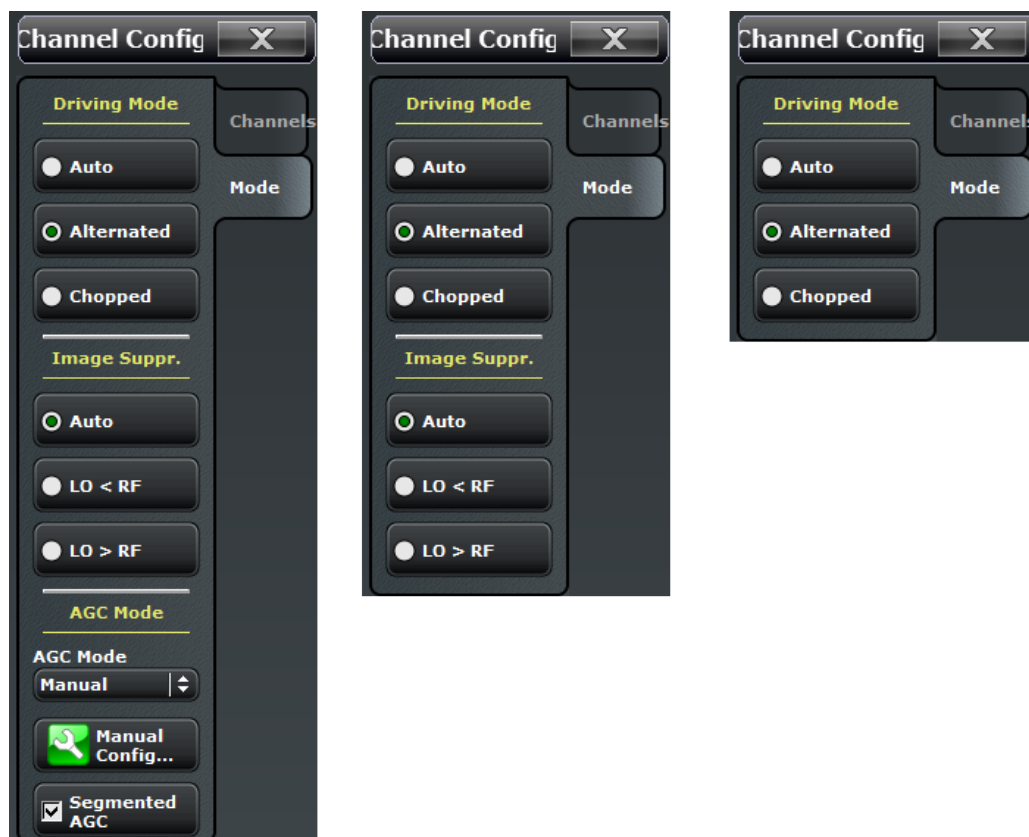

Figure 4-9: Channel Config > Mode softtool

left = R&S ZNC

middle = bidirectional R&S ZND

right = unidirectional R&S ZND

#### Driving Mode

Determines the order of partial measurements and sweeps.

- In "Auto" mode, the analyzer optimizes the display update: Fast sweeps are performed in "Alternated" mode, slower sweeps in "Chopped" mode.
- In "Alternated" mode, a partial measurement is performed at all sweep points (partial sweep) before the hardware settings are changed and the next partial measurement is carried out in an additional sweep. This is usually faster than "Chopped" mode.
- In "Chopped" sweep mode, the analyzer completes the necessary sequence of partial measurements at each sweep point and obtains the result (measurement

point) before proceeding to the next sweep point. A trace is obtained from the beginning of the sweep.

The "Driving Mode" setting is also used during a system error correction. For channels which require a single partial measurement only, the driving mode settings are equivalent. See also [Chapter 3.1.4.1, "Partial Measurements and Driving Mode"](#), on page 15.

Remote command:

```
[SENSe<Ch>:]COUPlE
```

### Image Suppr.

The "Image Suppr." settings define whether the analyzer measures with a local oscillator frequency LO below or above the RF input frequency. This feature can be used to eliminate known spurious components in the input signal that can distort the measurement, especially in the low frequency range.

- In "Auto" mode, the analyzer auto-selects the local oscillator frequency, depending on the receiver (RF) frequency and the test port. This mode systematically avoids known spurious signals provided that no frequency conversion occurs in the test setup.
- "LO > RF" means that the LO frequency is always above the measured RF frequency. This mode is appropriate for avoiding single, known spurious signals.
- "LO < RF" means that the LO frequency is always below the measured RF frequency. This mode is appropriate for avoiding single, known spurious signals.

**Tip:** In the presence of several spurious signals, setting the "Image Suppr." parameter globally may not be sufficient. To improve the result, perform a "Segmented Frequency" sweep and assign independent LO frequencies to the individual sweep segments.

**Note:** For a unidirectional R&S ZND (see [Chapter 3.1.4.2, "R&S ZND: Unidirectional vs. Bidirectional Operation"](#), on page 16) only the "Auto" mode is available and hence the "Image Suppr." section is hidden.

### Application example

Consider the following test setup with strongly reflecting DUT (e.g. a bandpass in its stop band) that is measured in transmission.  $a_1$  is generated at a frequency RF. The reflected wave  $b_1$  falls into the receiver mixer of the analyzer port 1, where a small fraction of the mixer product  $RF + 2*IF$  can be reflected back towards the DUT. If this spurious wave  $a'_1$  passes the DUT, then it is received as  $b'_2$  at port 2, together with the wanted signal  $b_2$ .

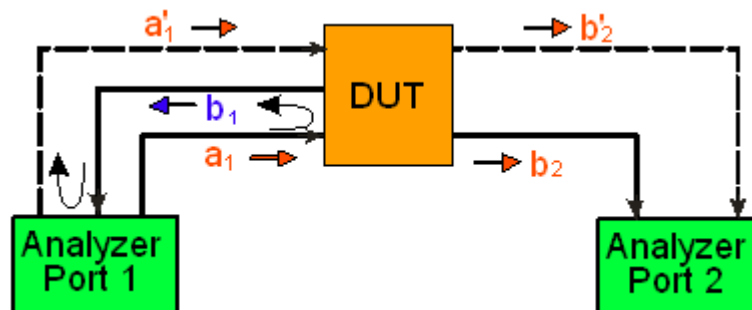

$LO > RF$  implies that  $LO = RF + IF$ . The mixer at port 2 converts both the wanted signal  $b_2$  and the spurious signal  $b'_2$  which is at the frequency  $RF' = IF + LO$ , to the same IF frequency. The response of an ideal, infinitely steep bandpass filter with a pass band between  $B^-$  and  $B^+$  looks as follows:

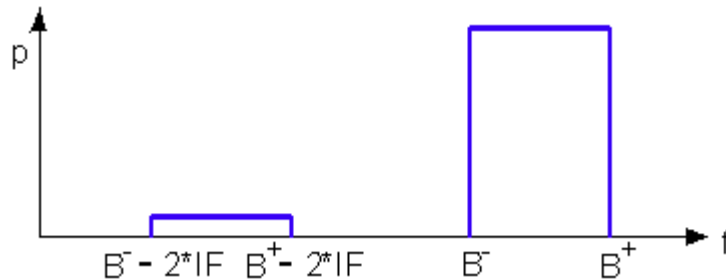

For a wide bandpass, the spurious response flattens the filter edges.

The spurious signal can be eliminated by dividing the sweep range into two segments with different LO settings:

- In the low-frequency segment, ranging up to the center frequency of the bandpass filter, the frequency of the local oscillator is set to  $LO < RF$ . This ensures that the spurious signal  $b'_2$  is not measured at port 2.
- In the high-frequency segment, starting at the center frequency of the bandpass filter, the frequency of the local oscillator is set to  $LO > RF$ . If the center frequency is larger than  $B^+ - 2*IF$ , then there is no distortion from  $b'_2$ .

Remote command:

[SENSe<Ch>:] FREQuency: SBANd

### AGC Mode

Configures the Automatic Gain Control (AGC).

In **"Auto"** mode the analyzer automatically adapts its receiver step attenuator settings to the RF input level ( $\rightarrow$  Automatic or Adaptive Gain Control, AGC). The A/D converter is always operated at optimum input level, selecting one of the following gain settings for every measurement point:

- **"Low Dist(ortion)"**, corresponding to a lower internal A/D converter input level. This setting allows for a high RF overdrive reserve and is appropriate for high RF input levels.
- **"Low Noise"** corresponding to a higher internal A/D converter input level. This setting increases the dynamic range and is appropriate for low RF input levels.

"Low Dist(ortion)" and "Low Noise" can also be selected **statically**, completely disabling the adaptive behavior. This is appropriate if the characteristics of the input paths must be constant, e.g. because

- interfering signal contributions originating from the receiver (noise, nonlinear contributions) must not change during the measurement.
- a large interfering signal in the vicinity of the measured signal must not overdrive the receiver.

**"Manual"** mode allows to select the preferred "AGC Mode" per sweep segment, drive port and receiver (see ["Manual Config..."](#) on page 303).

**Note:** For the R&S ZND only the "Low Distortion" mode is available and hence the "AGC Mode" section is hidden (see [Figure 4-9](#)).

Remote command:

```
[SENSe<Ch>:] POWer:GAINcontrol:GLOBal
```

### Manual Config...

Opens the "AGC Manual Configuration" dialog that allows to configure the Automatic Gain Control for the individual sweep segments, drive ports and receivers. This button is enabled in "Manual" [AGC Mode](#) only.

The manual AGC settings are persisted and reused for subsequent measurement sweeps, which may increase measurement speed compared to "Auto" mode while not compromising measurement quality.

- **Range:** If [Segmented AGC](#) is enabled, each sweep segment can be configured separately.
- **Drive Port, a, b<sub>j</sub>:** Selects the AGC mode for the respective drive port and receiver.
- **Auto (column):** Enables the automatic mode for the corresponding drive port, disabling the manual configuration for the related a- and b-waves.
- **Reset:** restores the default settings ("Auto" for all drive ports)
- **Learn Sweep:** During the learn sweep, the analyzer determines the appropriate static gain settings for the measured a- and b-waves, i.e. for all a- and b-waves measured in the current channel. The acquired settings can be overwritten manually.

At the start of the learn sweep, "Auto" mode is selected for each drive port ("Reset") and a single shot measurement of the current channel is initiated. During this measurement the VNA software observes the "Low Distortion" (LD) vs. "Low Noise" (LN) gain decisions of the AGC and derives the statically assigned gain for the individual sweep segments / drive ports / receivers as follows:

- if LD was selected for any of the related measurement points, then LD is assigned
- otherwise LN is assigned

In other words, LN is assigned if and only if LN was selected for all related measurement points.

### Note:

- For the R&S ZND only the "Low Distortion" AGC mode is available and hence the "AGC Mode" section is hidden (see [Figure 4-9](#)). In particular, there is no manual configuration option.
- Without the [Extended Power Range](#) option only the AGC of the measurement receivers (the b-waves) can be statically set to "Low Dist" or "Low Noise"; the reference receiver AGC mode is always set to "Auto" (see ["AGC Mode"](#) on page 302). With the option available, also the AGC of the reference receivers (the a-waves) can be set statically.
- Before running the "Learn Sweep", create the adequate port configuration and add the required traces.
- The "Learn Sweep" is not available for power sweep channels.
- The increase in measurement speed for settings "Low Dist" and "Low Noise" is not achieved if the AGC mode of one of the receivers is set to "Auto".

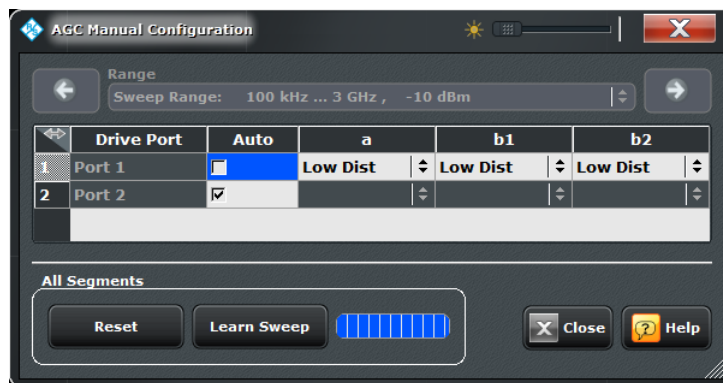

Remote command:

```
[SENSe<Ch>:] PWEr:GAINcontrol
[SENSe<Ch>:] PWEr:AGCMode:ACQuire
[SENSe<Ch>:] PWEr:AGCMode:SAVE
[SENSe<Ch>:] SEGment<Seg>:PWEr:GAINcontrol
```

### Segmented AGC

"Segmented AGC" enables segment specific gain settings. It is available for segmented sweep type only.

**Note:** For the R&S ZND only the "Low Distortion" mode is available and hence the "AGC Mode" section is hidden (see [Figure 4-9](#)).

Remote command:

```
[SENSe<Ch>:] SEGment<Seg>:PWEr:GAINcontrol:CONTROL
```

#### 4.4.4.4 Channel Config > Pwr Cal Settings

Provides access to all functions for power meter and power calibration data handling (transmission coefficients). The settings are identical with the "CHANNEL > CAL > Pwr Cal Settings" settings; see [Chapter 4.4.3.12, "Calibration > Pwr Cal Settings"](#), on page 286.

### 4.4.5 Trigger

The "Trigger" menu provides trigger and sweep control settings.

#### 4.4.5.1 Trigger > Trigger

Selects the source of the trigger signal and provides additional trigger settings.

#### Trigger system of the analyzer

The trigger system is used to synchronize the analyzer's actions with events that can be provided by an internal or external signal or user-generated ("Manual Trigger"). Triggered measurements are an alternative to the default mode ("Free Run", "Continu-



ous Sweep"), where the measurement is continuously repeated without fixed time reference.

Any trigger event may start an entire sweep or a part of it. Moreover, it is possible to switch off the RF source between consecutive triggered measurement sequences, and to define a delay between trigger events and the measurement sequences.

### Output trigger

The R&S ZNC/ZND provides a configurable output trigger signal to synchronize external devices with the measurement. This signal is available at the rear panel connector EXT TRIG OUT. Configuration of the output trigger signal is a remote control feature (TRIGger:CHANnel<Ch>:AUXiliary... commands; see [Chapter 6.3.20, "TRIGger Commands"](#), on page 738).



The trigger settings are also valid for calibration sweeps. This means that, in external trigger mode, the external trigger signal must be available during the system error correction, too. To start the calibration sweeps without delay, use the "Free Run" trigger type.



### Background information

Refer to [Chapter 3.1.4.1, "Partial Measurements and Driving Mode"](#), on page 15.

**Access:** CHANNEL > TRIGGER key or Alt + Shift + R



### Free Run / External / Manual / Multiple Triggers

The four buttons select the source of the trigger event:

- In "Free Run" mode a new measurement is started immediately without waiting for a trigger event and without fixed time reference. The remaining trigger settings are not valid.

"Free Run" means that a measurement in "Continuous Sweep" mode is repeated as fast as possible.

- In "External" trigger mode the measurement is triggered by an external 5 V TTL signal applied either to the BNC connector EXT TRIG IN or to pin 2 of the USER PORT connector at the rear panel. The two trigger inputs are equivalent; no additional setting for signal routing is required. For detailed specifications of the trigger signals refer to [Chapter 9.1.1.1, "USER PORT"](#), on page 803.

The "External" trigger mode can be configured using the "Sequence" and "Slope / Level" settings.

**Note:** The period of the external trigger signal should be adjusted to the triggered measurement sequence. If the analyzer receives a trigger event while the last sequence is still running, the R&S ZNC/ZND skips the trigger event and generates a message.

- In "Manual" trigger mode the trigger signal is generated on selecting the "Manual Trigger" softkey.
- In "Multiple Trigger" mode the trigger sources for different triggered measurement sequences, the trigger slope, and the trigger delay can be selected individually using the "Trigger Manager" dialog. In particular, it is possible to use two different external trigger sources.

See also [Chapter 4.4.5.2, "Trigger Manager \(Dialog\)"](#), on page 307.

Remote command:

`TRIGger<Ch> [:SEquence] :SOURce` on page 741

### Sequence

Selects the measurement cycle or sequence of actions to be triggered.

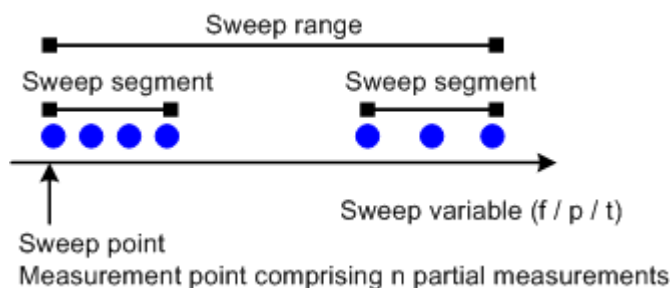

- "Sweep" means that each trigger event starts an entire sweep, according to the current sweep configuration.
- "Point" means that each trigger event starts the measurement at the next sweep point.
- "Partial Measurement" means that each trigger event starts the next partial measurement at the current or at the next sweep point. If each measurement points requires only one partial measurement, this option is equivalent to "Point". See also [Chapter 3.1.4.1, "Partial Measurements and Driving Mode"](#), on page 15.
- "Segment" means that each trigger event starts the next sweep segment within the current sweep. If a sweep type other than "Segmented Sweep" is active, this option is equivalent to "Sweep".

### Relation with other sweep settings

Some sweep settings are logically incompatible with a particular selection of the triggered measurement sequence:

- If a "Time" sweep is performed, the sequence is always a sweep.
- "Alternate" sweep mode only makes sense if the triggered measurement sequence comprises more than one sweep point. If "Point" or "Partial Measurement" is selected, Alternate sweep mode is switched off and vice versa.

**Note:** The period of the trigger events should be adjusted to the triggered measurement sequence. If the analyzer receives a trigger event while the last sequence is still running, the R&S ZNC/ZND skips the trigger event and generates a message.

Remote command:

```
TRIGger<Ch>[:SEquence]:LINK
```

### Delay

Specifies a delay time between the trigger event and the start of the measurement.

The Delay time entered must be zero or positive, so that the trigger event precedes the start of the measurement (post-trigger).

In "Multiple Trigger" mode the trigger delay can be selected individually using the "Trigger Manager" dialog. See [Chapter 4.4.5.2, "Trigger Manager \(Dialog\)"](#), on page 307.

Remote command:

```
TRIGger<Ch>[:SEquence]:HOLDoff
```

### Slope / Level

Specifies the "External" trigger mode in detail.

- **Rising Slope / Falling Slope** means that the rising or falling slope of every external trigger pulse can trigger a single measurement sequence.
- **High Level / Low Level** means that the analyzer performs a free run measurement as long as the external trigger signal is high / low. The measurement is discontinued when the trigger signal changes to low / high.

Remote command:

```
TRIGger<Ch>[:SEquence]:SLOPe
```

### Manual Trigger

Generates the trigger event for "Manual" trigger mode (see [Free Run / External / Manual / Multiple Triggers](#)). "Manual Trigger" is disabled unless manual trigger mode is active.

Remote command:

```
TRIGger<Ch>[:SEquence]:SOURCE on page 741 MANual
```

```
*TRG
```

#### 4.4.5.2 Trigger Manager (Dialog)

The "Trigger Manager" dialog defines individual trigger sources and delays for the triggered measurement sequences. The settings are valid for "Multiple Trigger" mode. For detailed specifications of the trigger signals refer to [Chapter 9.1.1.1, "USER PORT"](#), on page 803.



### Background information

Refer to [Chapter 3.1.4.1, "Partial Measurements and Driving Mode"](#), on page 15.

**Access:** CHANNEL > TRIGGER > Trigger > Trigger Manager...



**Figure 4-10:** Example of a multiple trigger configuration

The table in the "Trigger Manager" dialog contains several editable (white) or non-editable (gray) columns. All settings are analogous to the general trigger settings in the CHANNEL > TRIGGER > Trigger tab. Refer to the following sections:

- ["Sequence"](#) on page 306
- ["Free Run / External / Manual / Multiple Triggers"](#) on page 305
- ["Slope / Level"](#) on page 307
- ["Delay"](#) on page 307

### Source / Slope / Level / Delay

The table defines all multiple trigger settings. The following trigger sources are available:

- **Free Run** selects an untriggered measurement sequence.
- **External 1** is the external trigger signal fed in at either the EXT TRIG IN connector on the rear panel or pin 2 of the USER PORT connector.
- **External 2** is the external trigger signal fed in at pin 25 of the USER PORT connector on the rear panel.
- **External 1 and 2** means that the measurement sequence is initiated after the analyzer has received an event from both external trigger signals.
- **External 1 or 2** means that the measurement sequence is initiated after the analyzer has received an event from either external trigger 1 or external trigger 2.
- **Manual** means that the trigger event is generated manually, by selecting the "Manual Trigger" button in the "Trigger > Trigger" softtool.

In the example of [Figure 4-10](#) the sweep is triggered by an external trigger no. 1, while each sweep point is triggered by external trigger no. 2. With this multiple trigger configuration, the first trigger 1 event enables the overall sweep. The first trigger 2 event after the trigger 1 event initiates the measurement of the first sweep point, the second trigger 2 event initiates the measurement of the second sweep point and so on. Trigger 1 events are ignored until the last sweep point has been measured and the next sweep is started. In the figure below, dotted arrows depict ignored trigger events.

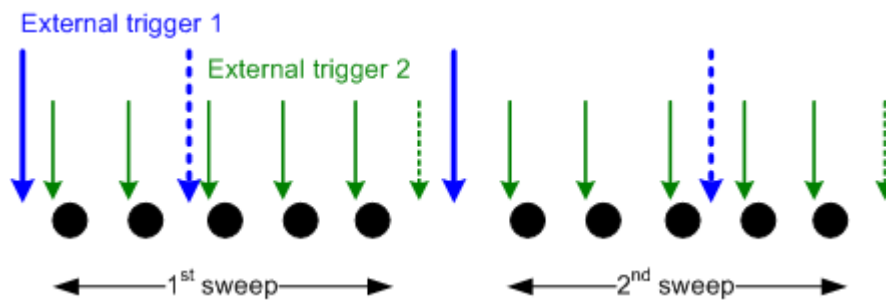

Remote command:

```
TRIGger<Ch>[:SEquence]:MULTiple:SOURce
TRIGger<Ch>[:SEquence]:MULTiple:SLOPe<Num>
TRIGger<Ch>[:SEquence]:MULTiple:HOLDoff
```

#### 4.4.5.3 Trigger > Sweep Control

Selects the number of sweeps per measurement cycle. The settings are identical with the "Sweep > Sweep Control" settings; see [Chapter 4.4.2.5, "Sweep > Sweep Control"](#), on page 249.

#### 4.4.6 Offset Embed

The "Offset Embed" softtool allows to define a length offset and loss for each test port, compensating for the known length and loss of (non-dispersive and perfectly matched) transmission lines between the calibrated reference plane and the DUT.

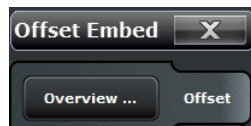

#### Background information

Refer to [Chapter 3.6, "Offset Parameters and Embedding"](#), on page 103

##### 4.4.6.1 Offset Embed Dock Widget

On activating a tab in the "Offset Embed" softtool, a dock widget is displayed at the south of the application window, whose content pane is synchronized with the selected softtool tab.

#### Overview

Shows an overview of the overall calculation flow and allows quick access to the "Offset Embed" functions.

**Access:** CHANNEL > OFFSET EMBED key or Alt + Shift + Q > Overview

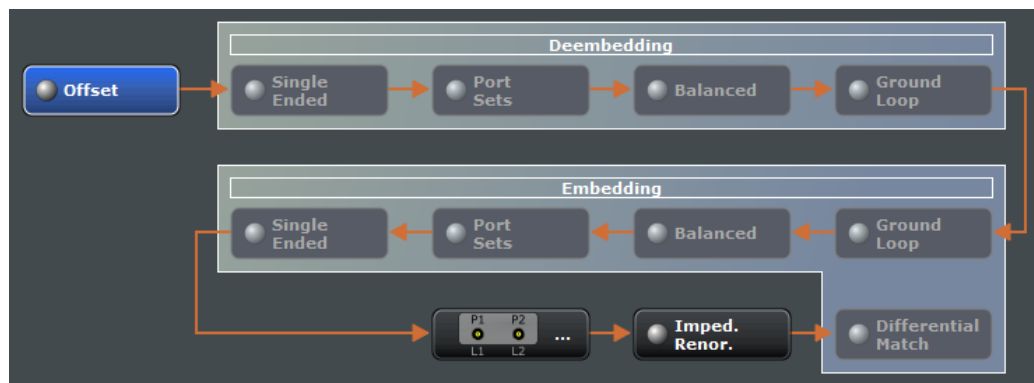

Figure 4-11: Offset Embed dock widget: Overview (Calculation Flow)

Use one of the buttons to configure the corresponding function. A green LED on a button indicates that the corresponding deembedding/embedding function is active.

**Note:** The advanced "Deembedding"/"Embedding" functions are neither available for the R&S ZNC nor for the R&S ZND (greyed out in the "Overview"). If in addition the "Fixture Simulator" is disabled for the related channel (see "Fixture Simulator" on page 298), only the "Offset" function remains active.

**Offset**

Allows to activate or deactivate offset/loss correction for selected physical ports and to set related parameters.

Offset							Reset Offsets
Offset	Active	Delay	Permittivity	Loss at DC	Loss at Freq	Freq for Loss	
P1  ----- L1	<input checked="" type="checkbox"/>	0 s	1.001	0 dB	0 dB	1 GHz	
P2  ----- L2	<input checked="" type="checkbox"/>	0 s	1.001	0 dB	0 dB	1 GHz	

Figure 4-12: Offset Embed dock widget: Offset

This panel can be activated from the Overview or by selecting the Offset Embed > Offset or Offset Embed > One Way Loss softtool tab.

Refer to the description of these softtool tabs for background information, additional parameters and remote commands.

The checkbox in the "Active" column activates/deactivates the configured length and loss parameters for the respective Port (i.e. adds/removes them to/from the calculation flow) without changing the parameter values.

The "Reset Offsets" button resets the length and loss parameters for all ports to their default values.

Remote command:

```
[SENSe<Ch>:]CORRection:OFFSet<PhyPt>:COMPensation[:STATe]
on page 636
[SENSe<Ch>:]CORRection:OFFSet<PhyPt>[:STATe]
```

### Impedance Renormalization

This panel provides an alternative access to the reference impedance settings (see "Reference Impedance" on page 134).

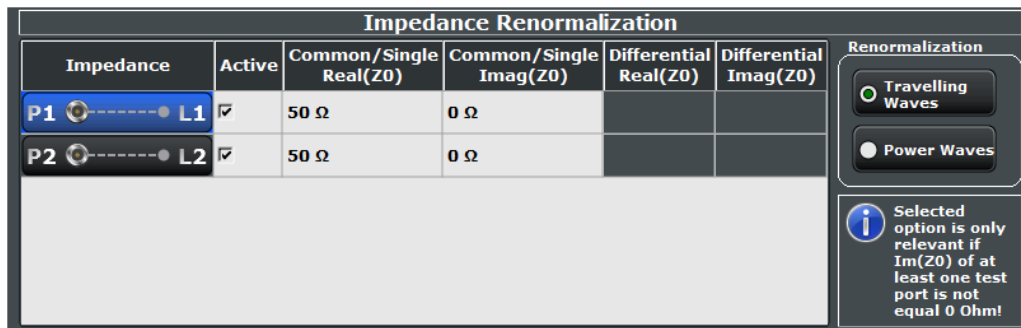

**Note:** For a unidirectional R&S ZND (see [Chapter 3.1.4.2, "R&S ZND: Unidirectional vs. Bidirectional Operation"](#), on page 16) balanced measurements are not available and hence the columns for the "Differential" mode impedance are hidden.

The "Active" flags are inversely related to the "Use Default" flags of the logical port configuration:

Active	Use Default
<input checked="" type="checkbox"/>	<input type="checkbox"/>
<input type="checkbox"/>	<input checked="" type="checkbox"/>

#### 4.4.6.2 Offset Embed > Offset

Defines length offset parameters for each port.

Use the complementary dock widget to activate or deactivate length/loss compensation for selected ports (see "Offset" on page 310).



The "Zero Delay at Marker" function overwrites the offset parameters.



#### Background information

Refer to the following sections.

- [Chapter 3.6, "Offset Parameters and Embedding"](#), on page 103
- [Chapter 3.6.1.1, "Definition of Offset Parameters"](#), on page 103
- [Chapter 3.6.1.3, "Auto Length"](#), on page 104
- [Chapter 3.6.1.6, "Application and Effect of Offset Parameters"](#), on page 108
- [Chapter 3.6.1.7, "Offset Parameters for Balanced Ports"](#), on page 108
- [Chapter 3.6.1.5, "Fixture Compensation"](#), on page 107

**Access:** CHANNEL > OFFSET EMBED key or Alt + Shift + Q

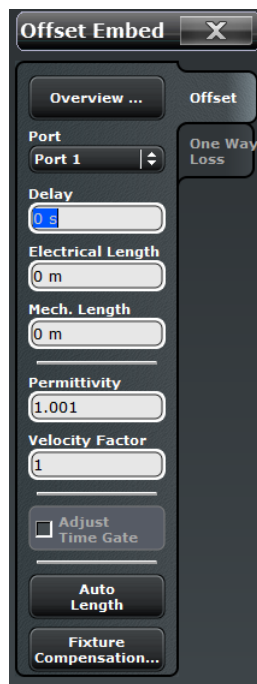

For Fixture Compensation, see "[Fixture Compensation](#)" on page 314.

### Overview

This button is available on all "Offset Embed" softtool tabs. It opens the [Overview](#) in the [Offset Embed Dock Widget](#).

### Port

Physical test port of the analyzer. You can define independent offset parameters for all ports.

Remote command:

The <PhyPt> numeric suffix in the [SENSe<Ch>:]CORRection:... commands identifies the physical port.

### Delay / Electrical Length / Mechanical Length

Defines the length offset at the selected port as a delay, an electrical length, or a mechanical length. The three quantities are related by:

$$Delay = \frac{L_{mech} \cdot \sqrt{\epsilon_r}}{c}; \quad Electrical\ Length = L_{mech} \cdot \sqrt{\epsilon_r}$$

and overwrite each other. See also [Chapter 3.6.1.1, "Definition of Offset Parameters"](#), on page 103.

**Note:** The entered parameters must correspond the actual (one-way) length of the transmission line. To account for the propagation in both directions, the phase shift of a reflection parameter due to a given length offset is twice the phase shift of a transmission parameter. For a numeric example see [Chapter 3.6.1.6, "Application and Effect of Offset Parameters"](#), on page 108.



Remote command:

```
[SENSe<Ch>:]CORRection:EDELay<PhyPt>[:TIME]
[SENSe<Ch>:]CORRection:EDELay<PhyPt>:ELENgth
[SENSe<Ch>:]CORRection:EDELay<PhyPt>:DISTance
```

### Permittivity / Velocity Factor

Defines the permittivity ( $\epsilon_r$ ) and velocity factor of the dielectric in the transmission line between the reference plane and the DUT. The velocity factor is  $1/\sqrt{\epsilon_r}$  and is a measure for the velocity of light in a dielectric with permittivity  $\epsilon_r$  relative to the velocity of light in the vacuum (velocity factor < 1). Permittivity and velocity factor are coupled parameters.

See also [Chapter 3.6.1.1, "Definition of Offset Parameters"](#), on page 103.

Remote command:

```
[SENSe<Ch>:]CORRection:EDELay<PhyPt>:DIElectric
```

### Adjust Time Gate

Activates the operating mode where the time gate is moved in the opposite direction when the "Delay" setting (or any other length offset parameter) is changed. The button is available if a time gate is active ("TRACE > TRACE CONFIG > Time Gate > Time Gate: On"). In time domain, a positive delay shifts the time gate to the left, a negative delay shifts it to the right.

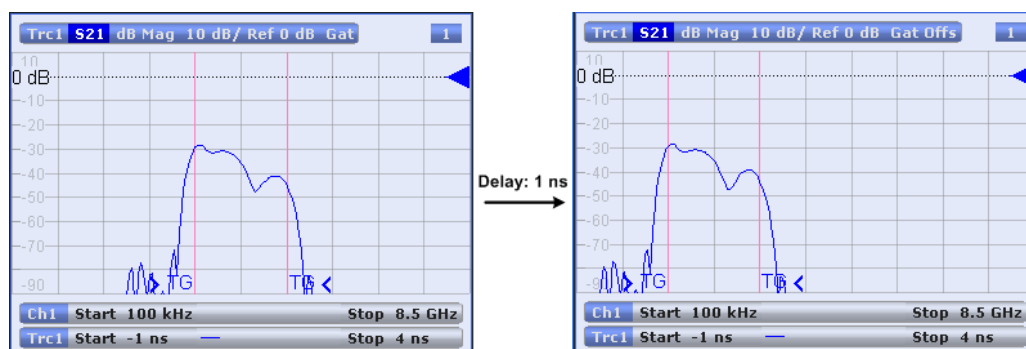

The position of the time gate is always relative to the end of the offset transmission line. As a consequence, "Adjust Time Gate" allows measurements at variable offset but fixed time gate position.

**Example:** The impedance of an antenna with possible faults is measured using a time gate and a variable length offset. If "Adjust Time Gate" is off, the time gate is at a constant distance from the the offset-corrected reference plane (end of the offset transmission line). Its absolute position is varied along with the length offset.

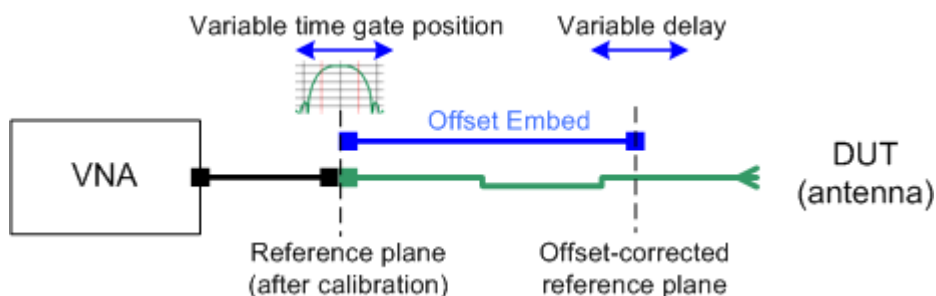

If "Adjust Time Gate" is on, the time gate is moved to left (right) when the offset-corrected reference plane is moved to the right (left). Its absolute position remains fixed. With this setting, it is possible e.g. to keep the time gate at the position of the antenna connector while the antenna is measured at different length offsets.

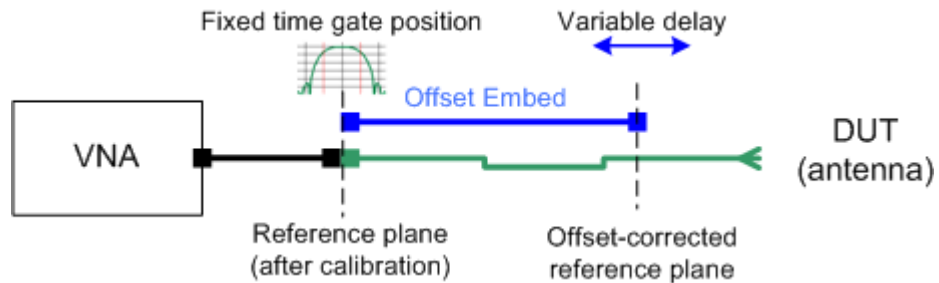

Remote command:

```
CALCulate:FILTer[:GATE]:TIME:AOffset
```

### Auto Length

Adds an electrical length offset to the selected test port with the condition that the residual delay of the active trace (defined as the negative derivative of the phase response) is minimized across the entire sweep range. If "Delay" is the selected trace format, the entire trace is shifted in vertical direction and centered around zero. In phase format, the "Auto Length" corrected trace shows the deviation from linear phase.

If the measured quantity is a ratio, or if it is derived from a ratio, its receiving port is given as the index of the wave quantity in the numerator. If the active trace shows an S-parameter  $S_{ij}$ , then "Auto Length" adds a length offset at port  $i$ .

See also [Chapter 3.6.1.3, "Auto Length"](#), on page 104.

Remote command:

```
[SENSe<Ch>:]CORRection:EDELay<PhyPt>:AUTO
```

### Fixture Compensation

"Fixture Compensation" opens a dialog that allows to correct the measurement result for the effects of a test fixture.

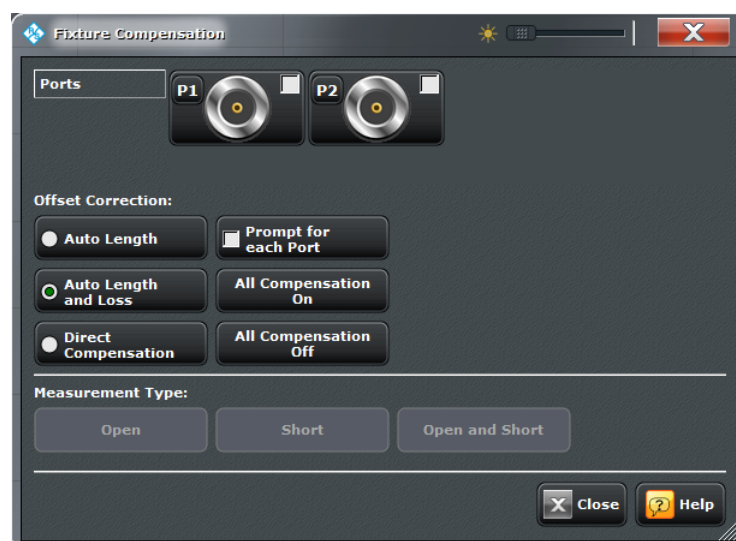

The "Fixture Compensation" dialog provides the following control elements:

- "Ports" selects the ports for whom fixture compensation data shall be acquired.  
**Note:** For a unidirectional R&S ZND (see [Chapter 3.1.4.2, "R&S ZND: Unidirectional vs. Bidirectional Operation"](#), on page 16) port 2 can not be used as source port and hence P2 is hidden in this dialog.
- "Offset Correction" selects the type of compensation that the network analyzer calculates from the acquired compensation data. "Auto Length" or "Auto Length and Loss" implies that a global electrical length offset and loss is determined in analogy to the general offset compensation (see [Chapter 3.6.1.3, "Auto Length"](#), on page 104 and [Chapter 3.6.1.4, "Auto Length and Loss"](#), on page 105). With "Direct Compensation", a frequency-dependent transmission factor is calculated; see ["Auto Length and Loss vs. Direct Compensation"](#) on page 107.
- "Prompt for each port" determines how the R&S ZNC/ZND performs the sweeps for a given termination type (Open and/or Short; see "Measurement Type" below). If unchecked, it performs the sweeps for Open/Short without interruption, implicitly assuming that **all** ports are terminated accordingly  
If checked, it interrupts the data acquisition process after each port, which allows you to modify the test setup (e.g. terminate the next measured port).
- "All Compensation On"/"All Compensation Off" activates/deactivates the length and loss compensation for all ports.  
Use the "Active" column in the [Offset](#) panel to activate/deactivate the length and loss compensation for selected ports.
- "Measurement Type": The "Open", "Short", and "Open and Short" buttons bring up the ["Measure Fixture"](#) dialog that guides you through the actual fixture measurement. See ["Open / Short vs. Open and Short compensation"](#) on page 107.

**Tip:** Remote control provides additional flexibility. You can:

- Measure the same port(s) repeatedly without changing the standards and attribute the results to different channels.
- Calculate the compensation data for different ports, using mixed Open and Short standards.

Refer to the program example for `[SENSe<Ch>:]CORRection:COLLect:FIXTure[:ACQuire]`.

**Tip:** For further reference see [Chapter 3.6.1.5, "Fixture Compensation"](#), on page 107.

Remote command:

```
[SENSe<Ch>:]CORRection:COLLect:FIXTure[:ACQuire]
[SENSe:]CORRection:COLLect:FIXTure:LMPParameter:LOSS[:STATe]
[SENSe:]CORRection:COLLect:FIXTure:LMPParameter[:STATe]
[SENSe<Ch>:]CORRection:OFFSet<PhyPt>:COMPensation[:STATe]
[SENSe<Ch>:]CORRection:OFFSet<PhyPt>:DFComp[:STATe]?
```

### Measure Fixture ← Fixture Compensation

The "Measure Fixture" dialog acts as a wizard for fixture compensation measurements, as configured in the "Fixture Compensation" dialog.

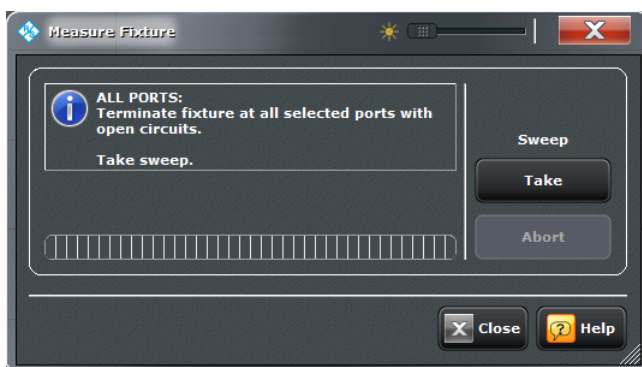
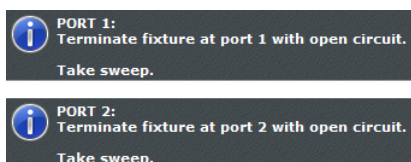

Figure 4-13: Measure Fixture dialog: Auto Length (and Loss)

To acquire the necessary data, proceed as indicated in the information area.

With "Prompt for each Port" disabled, "Take" acquires data for all selected "Ports" in one go. Otherwise sweeps are taken port by port.



For "Direct Compensation" it is also possible to save the acquired data to file. In future measurements you can load these files instead of repeating the data acquisition.

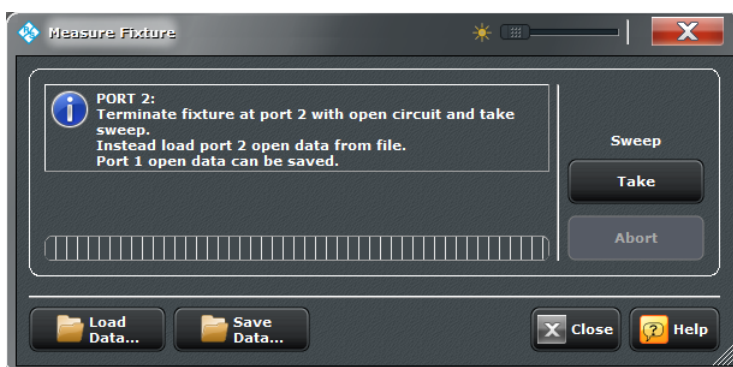

Figure 4-14: Measure Fixture dialog: Direct Compensation (and "Prompt for each port")

"Direct Compensation" data files are standard trace files, containing reflection parameter traces for the related port(s) and standard:

Table 4-2: Direct Compensation data

"Prompt for each Port"	File Type	Description
disabled	csv	One csv trace file per standard, containing reflection traces for all selected ports; see <a href="#">Chapter 3.4.2.2, "ASCII (*.csv) Files"</a> , on page 71
enabled	s1p	One 1-port Touchstone file per standard and port (see <a href="#">Chapter 3.4.2.1, "Touchstone Files"</a> , on page 69)

Remote command:

```
[SENSe<Ch>:]CORRection:COLLect:FIXTure:START
[SENSe<Ch>:]CORRection:COLLect:FIXTure[:ACQuire]
[SENSe<Ch>:]CORRection:COLLect:FIXTure:SAVE
[SENSe<Ch>:]CORRection:COLLect:FIXTure:EXPort
[SENSe<Ch>:]CORRection:COLLect:FIXTure:IMPort
```

#### 4.4.6.3 Offset Embed > One Way Loss

Defines loss parameters for each physical port.

Use the complementary dock widget to activate or deactivate length/loss compensation for selected ports (see ["Offset"](#) on page 310).



#### Background information

Refer to the following sections.

- [Chapter 3.6, "Offset Parameters and Embedding"](#), on page 103
- [Chapter 3.6.1.2, "Definition of Loss Parameters"](#), on page 104
- [Chapter 3.6.1.4, "Auto Length and Loss"](#), on page 105
- [Chapter 3.6.1.5, "Fixture Compensation"](#), on page 107

**Access:** CHANNEL > OFFSET EMBED key or Alt + Shift + Q



For Fixture Compensation, see ["Fixture Compensation"](#) on page 314.

### Overview

See ["Overview"](#) on page 312.

### Port

Physical test port of the analyzer. You can define independent loss parameters for all ports.

Remote command:

The <PhyPt> numeric suffix in the [SENSe<Ch>:]CORRection:... commands identifies the physical port.

### Loss at DC / Loss at Freq / Freq for Loss

Defines the one-way loss parameters for the transmission line at the selected port. The loss can be modeled as the sum of a constant and a frequency-dependent part. The total loss is approximated by an expression of the following form:

$$Loss(f) = [Loss(f_{ref}) - Loss_{DC}] \sqrt{\frac{f}{f_{ref}}} + Loss_{DC}$$

This means that all three loss parameters enter into the calculation of the loss.

See also [Chapter 3.6.1.2, "Definition of Loss Parameters"](#), on page 104.

**Note:** The entered parameters define the loss for a signal traveling in one direction through the transmission line. To account for the propagation in both directions, the magnitude shift of a reflection parameter due to a given loss is twice the magnitude shift of a transmission parameter. See also [Chapter 3.6.1.6, "Application and Effect of Offset Parameters"](#), on page 108.

Remote command:

[SENSe<Ch>:]CORRection:LOSS<PhyPt>:OFFSet

[SENSe<Ch>:]CORRection:LOSS<PhyPt>

[SENSe<Ch>:]CORRection:LOSS<PhyPt>:FREQuency

### Auto Length and Loss

Determines all offset parameters such that the residual group delay of the active trace (defined as the negative derivative of the phase response) is minimized and the measured loss is minimized as far as possible across the entire sweep range.

See also [Chapter 3.6.1.4, "Auto Length and Loss"](#), on page 105.

**Note:** If "Auto Length and Loss" is used with a line connected to a test port, the end of the line should be left open.

Remote command:

```
[SENSe<Ch>:]CORRection:LOSS<PhyPt>:AUTO
```

### Fixture Compensation

See ["Fixture Compensation"](#) on page 314

## 4.5 Display Settings

The "Display" menu provides all display settings and the functions for activating, modifying and arranging different diagrams.



### Related information

Refer to the following sections:

- [Chapter 3.1.3, "Traces, Channels and Diagrams"](#), on page 12
- [Chapter 3.2.2, "Display Elements in the Diagram"](#), on page 25
- See chapter "Operating the Instrument > Handling Diagrams, Traces, and Markers" in the Help system or in the R&S ZNC/ZND Getting Started guide.

---

### 4.5.1 Display > Diagram

Selects a diagram as the active diagram, defines a title, deletes or adds diagrams and arranges them on the screen. Many of the functions are unavailable if the active recall set contains only one diagram.



### Related settings

Use the icons in the toolbar to add diagrams and traces. Use the "Zoom Active Trc" icon to zoom into a rectangular portion inside a diagram. See also chapter "Operating the Instrument > Handling Diagrams, Traces, and Markers" and "Using the Graphic Zoom" in the Help system or in the R&S ZNC/ZND Getting Started guide.

---

**Access:** SYSTEM > DISPLAY key or Alt + Shift + S



### Active Diagram

Selects the active diagram.

Each recall set screen can display several diagrams simultaneously, each with a variable number of traces. One of these diagrams and traces is active at each time. The diagram number in the upper right corner of the active diagram is highlighted. At the same time the active trace is highlighted in the trace list on top of the active diagram (Trc3 in the figure below):



The analyzer provides several tools for activating diagrams:

- tap on a point in the diagram to activate the diagram including the last active trace in the diagram.
- tap on a trace list to activate the trace including the corresponding diagram.
- Some of the functions of the "TRACE > TRACE CONFIG > Traces" tab activate a particular trace including the corresponding diagram.

Remote command:

The numeric suffix <Wnd> appended to the `DISPlay:WINDow<Wnd>:...` commands selects a diagram area.

### Add Tr+Diag

Creates a new diagram and a new trace which is displayed in the new diagram. The trace is created with the channel settings of the previous active trace but with default trace settings. The new diagram area is numbered <n>, where <n> is the largest of all existing diagram area numbers plus one.

**Tip:** The function of the "Add Trace" icon in the toolbar is similar to "Add Tr+Diag".

Remote command:

`DISPlay[:WINDow<Wnd>][:STATE] ON`



### Delete Diagram

Deletes the current diagram area including all traces displayed in the diagram area. The remaining diagrams are re-numbered; each recall set always contains diagrams with contiguous numbers. "Delete Diag Area" is disabled if the recall set contains only one diagram area: In manual control, each recall set must contain at least one diagram area with one channel and one trace.

**Tip:** To restore a diagram area that was unintentionally deleted, use "SYSTEM > UNDO".

Remote command:

```
DISPlay[:WINDow<Wnd>] [:STATe] OFF
```

### Maximize

The toggle icons below "Maximize" arrange all diagrams in tiles or maximize the active diagram with all traces to occupy the whole screen.

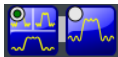

For other split types use the functions in the "Split" tab.

Remote command:

```
DISPlay[:WINDow<Wnd>]:MAXimize on page 521
```

### Title

Defines a title and shows it in the active diagram. The title may comprise a practically unlimited number of characters and is centered in a line below the top of the diagram area.

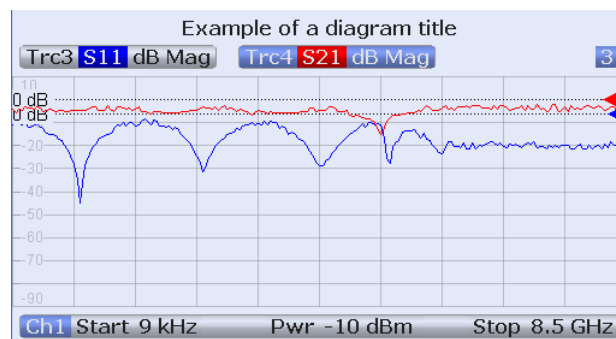

Remote command:

```
DISPlay[:WINDow<Wnd>]:TITLE:DATA
DISPlay[:WINDow<Wnd>]:TITLE[:STATe]
```

In remote control, it is also possible to define a diagram name, and to retrieve lists of diagram areas and traces:

```
DISPlay[:WINDow<Wnd>]:NAME
DISPlay[:WINDow<Wnd>]:CATalog?
DISPlay[:WINDow<Wnd>]:TRACe<WndTr>:CATalog?
```

### Overlay All

Places all traces in a single diagram area which is maximized to occupy the whole screen. This function is available irrespective of the trace format and the channel settings; it is even possible to overlay Cartesian and polar diagrams.

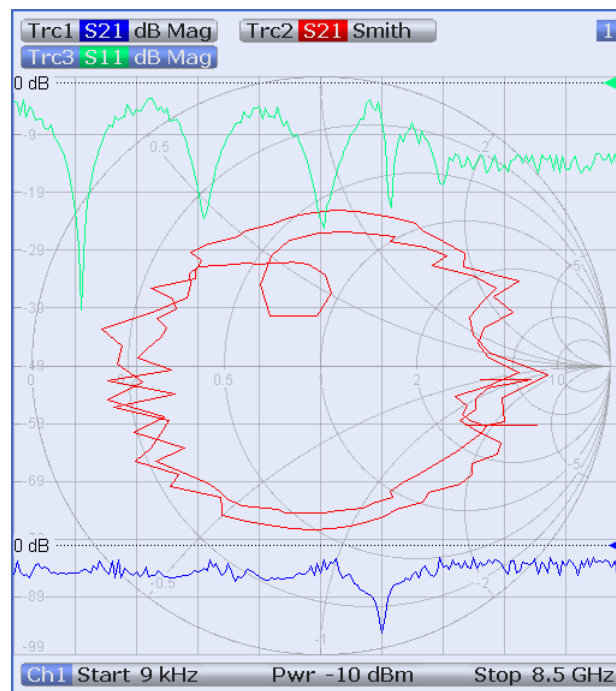

The active trace and active channel is highlighted. The scaling of the axes corresponds to the active trace.

**Tip:** To hide all traces except one, activate the context menu of the respective trace name segment in the trace list and select "Hide all other Traces".

Remote command:

No command; display configuration only.

### Split All

Splits the active window into as many diagrams as there are traces and assigns a single trace to each area.

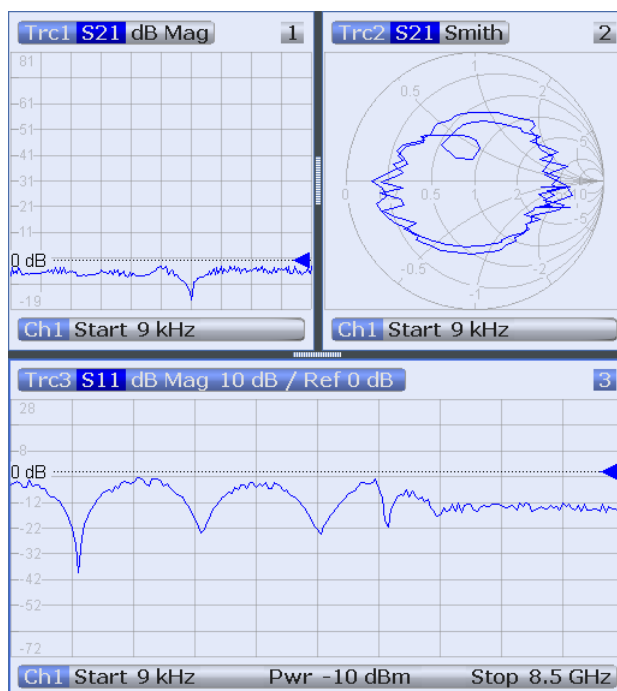

**Tip:** To vary the size and position of the diagram areas, drag and drop the separating frames or use the functions in the "Split" tab.

Remote command:

No command; display configuration only.

#### Additional Functionality: Zoom Active Trc

The "Zoom Active Trc" icon in the toolbar magnifies a rectangular portion of the diagram (zoom window) to fill the entire diagram area. See also [Chapter 4.2.3.3, "Scale > Zoom"](#), on page 161 or chapter "Operating the Instrument > Using the Graphic Zoom" in the Help system or in the R&S ZNC/ZND Getting Started guide.



Remote command:

```
DISPlay[:WINDow<Wnd>]:TRACe<WndTr>:ZOOM:BOTTom
DISPlay[:WINDow<Wnd>]:TRACe<WndTr>:ZOOM:START
DISPlay[:WINDow<Wnd>]:TRACe<WndTr>:ZOOM:STOP
DISPlay[:WINDow<Wnd>]:TRACe<WndTr>:ZOOM:TOP
DISPlay[:WINDow<Wnd>]:TRACe<WndTr>:ZOOM[:STATe]
```

## 4.5.2 Display > Split

Arranges different diagrams on the screen.

**Access:** SYSTEM > DISPLAY key or Alt + Shift + S

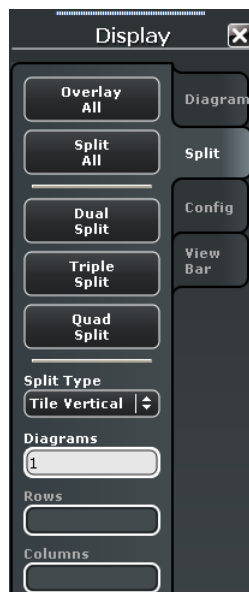

Some of the "Split" settings are also available in the "Display > Diagram" tab. Refer to the following sections:

- "Overlay All" on page 321
- "Split All" on page 322

#### Dual Split / Triple Split / Quad Split

Splits the window into two (three / four) diagrams and distributes the traces among the diagrams, separating diagrams with different trace format and channel settings (e.g. Cartesian and polar diagrams), if possible. Example of four traces in "Quad Split" display:

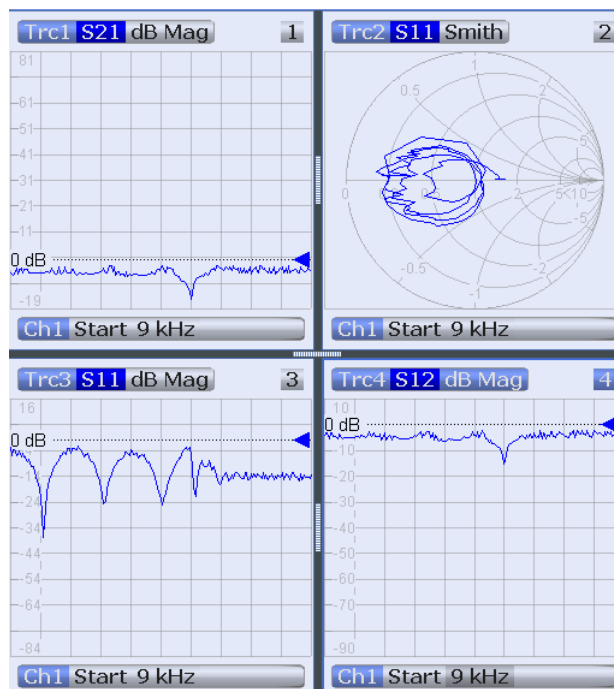

If less than two (three / four) traces are available, the new diagrams are created with a default trace. Dual (triple / quad) split corresponds to "Split Type: Tile Horizontal" with 2 (3 / 4) diagrams.

**Tip:** To vary the size and position of the diagrams, drag and drop the separating frames or use the functions in the "Diagram" tab.

Remote command:

No command; display configuration only.

#### Split Type / Diagrams / Rows / Columns

Arranges the diagrams in rows or columns and distributes the traces among the selected number of "Diagrams". The R&S ZNC/ZND provides the following split types:

- **Lineup:** The diagrams are arranged side by side; each diagram occupies the entire screen height.
- **Stack:** The diagrams are arranged one on top of the other; each diagram occupies the entire screen width.
- **Tile horizontal:** The diagrams are arranged in horizontal rows. With 2 (3 / 4) diagrams, the result is equivalent to Dual Split (Triple Split / Quad Split); see "[Dual Split / Triple Split / Quad Split](#)" on page 324.
- **Tile vertical:** The diagrams are arranged in vertical rows.
- **Rows + Columns:** The diagrams are arranged as a rectangular matrix. The number of rows and columns is as defined in the corresponding input fields.

If the selected number of "Diagrams" exceeds the number of traces, some of the new diagrams are created with a default trace.

**Tip:** To vary the size and position of the diagrams, drag and drop the separating frames or use the functions in the "Diagram" tab.

Remote command:

`DISPlay:LAYout`

`DISPlay:LAYout:GRID`

#### Additional Functionality: SCPI Commands

The analyzer provides remote control commands for efficient diagram handling. The commands listed below extend the functionality of the "Display > Diagram" and "Display > Split" softtool panels. For programming examples refer to [Chapter 7.2.2.6, "Creating Diagrams"](#), on page 784.

Remote command:

`DISPlay:LAYout:APPLY`

`DISPlay:LAYout:DEFine`

`DISPlay:LAYout:EXECute`

`DISPlay:LAYout:JOIN`

### 4.5.3 Display > Config

Displays or hides controls and information elements of the screen and controls the appearance of the individual diagrams.

Hiding the controls and information elements leaves more space for the diagrams. All elements may be shown or hidden simultaneously.



### Related information

Refer to [Chapter 3.2.2, "Display Elements in the Diagram"](#), on page 25

**Access:** SYSTEM > DISPLAY key or Alt + Shift + S



### Color Scheme

Controls the colors in the diagram areas. Color schemes are global settings and apply to all active recall sets.

The following predefined color schemes are optimized for the analyzer screen and for color hardcopies, respectively:

- "Dark Background" sets a black background color. The traces and information elements in the diagram areas are displayed in different colors. This setting is usually suitable for observing results on the analyzer screen.
- "Light Background" sets a light background color. The traces and information elements in the diagram areas are displayed in different colors. This setting is suitable for generating color hardcopies of the screen. All example images in this user documentation are based on this color scheme.

The following predefined color schemes can be appropriate for generating black and white hardcopies of the screen:

- "Black and White Line Styles" sets a white background color. All traces and information elements in the diagram areas are black, however, the traces are drawn in different line styles.
- "Black and White Solid" sets a white background color. All traces and information elements in the diagram areas are black. All traces are drawn with solid lines.

"User Define..." opens a dialog to modify the predefined schemes, changing the colors and styles of the individual display elements. See [Chapter 4.5.4, "Define User Color Scheme \(Dialog\)"](#), on page 328.

Remote command:

```
SYSTem:DISPlay:COLor
```

**Hide Sensitive Information**

Unmasks or masks all stimulus value occurrences in the VNA GUI for the current recall set.

When you check "Hide Sensitive Information" for a particular recall set (to mask the stimulus values) you are asked to set a password. If this password non-empty it will be requested the next time someone tries to uncheck "Hide Sensitive Information" (to unmask all stimulus values) for this recall set.



Both checked state and password are stored in (and loaded from) the recall set.

Remote command:

```
DISPlay:ANNotation:FREQuency[:STATE]
```

**Channel Info**

Shows or hides the channel lists in the lower part of the diagrams.

Ch1	Start	100 kHz	Pwr	-10 dBm	Bw	10 kHz	Stop	3 GHz
Ch2	Start	100 kHz	Pwr	-10 dBm	Bw	10 kHz	Stop	3 GHz
Ch3	Freq	1 GHz	Pwr	-10 dBm	Bw	10 kHz	Stop	1 s
Ch4	Start	100 kHz	Pwr	-10 dBm	Bw	10 kHz	Stop	3 GHz
Trc4	Start	-1 ns	Time Domain				Stop	4 ns

Remote command:

```
DISPlay:ANNotation:CHANnel[:STATE]
```

**Trace Info**

Shows or hides the trace lists in the upper part of the diagrams.



Remote command:

```
DISPlay:ANNotation:TRACe[:STATE]
```

**Info Table / Position**

Shows or hides the info table. The info table is a possible container for the marker info fields and may be placed to the bottom, to the left, or to the right of the screen. See also Chapter 4.2.6.9, "Marker > Info Field", on page 227.

M1	Trc1	5.100040	GHz	-15.2736	dB	Bandstop	Trc1	Ref to Max	Track
M2	Trc1	4.568776	GHz	-4.7532	dB	Bandwidth		991.256235	MHz
M3	Trc1	5.560033	GHz	-4.7532	dB	Center		5.040094	GHz
M4	Trc1	5.040094	GHz	-11.1110	dB	Lower Edge		4.568776	GHz
						Upper Edge		5.560033	GHz
						Quality Factor		5.085	U
						Loss		15.2736	dB

Remote command:

No command; display configuration only.

**Font Size**

Selects the font size of all textual information elements in the diagrams. This comprises the trace and channel lists, and the marker info fields.

Remote command:

[DISPlay:RFSize](#)

**4.5.4 Define User Color Scheme (Dialog)**

The "Define User Color Scheme" dialog modifies the predefined color schemes, changing the colors and styles of the individual display elements. User-defined color schemes can be saved to a file for later re-use.

**Related settings**

Refer to "[Color Scheme](#)" on page 326

**Access:**SYSTEM > DISPLAY > Config > User Define...

**Element**

Selects the screen element to be modified. The list contains the background and all traces, text elements and lines in the diagrams.

Remote command:

The `<DispEl>` suffix in the `DISPlay:CMAP<DispEl>...` commands identifies the screen element. See [DISPlay:CMAP<DispEl>:RGB](#).

**Properties**

Configures the selected screen element.

- "Color" opens a standard color dialog where you can assign a color to the selected element.
- "Trace Line Style" and "Trace Line Width" are enabled if the selected element is a trace.



Remote command:

```
DISPlay:CMAP<DispEl>:RGB
```

```
DISPlay:CMAP:TRACe:RGB
```

### Limit Test > Show Limit Fail Symbols

Displays or hides the colored squares on the trace indicating failed measurement points. Hide the squares if they cover too much of the trace. Instead of using the limit fail symbols, you can colorize the trace to highlight failed trace sections.

Remote command:

```
DISPlay:CMAP:LIMit:FSYMBOL[:STATE]
```

### Limit Test > Colorize Trace when Failed

Assigns a different trace color to failed trace segments. The different color reaches from the last passed measurement point before the start of the failed segment to the last failed measurement point in the segment. This means that the beginning of the colorized trace is possibly outside the failed range.

The example below shows a lower limit line at  $-10$  dB. Due to the rule described above, a marker placed on the colorized ("failed") trace point at 5.004050 GHz still indicates a response value within the allowed range ( $-9.7222$  dB  $>$   $-10$  dB).

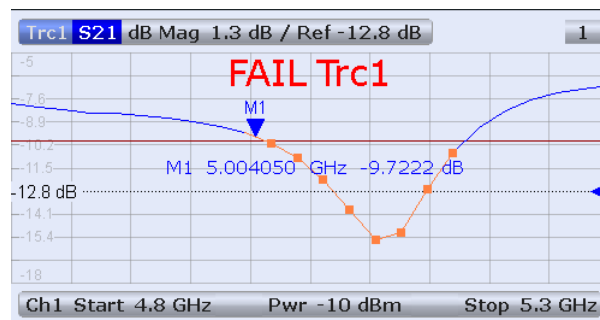

Remote command:

```
DISPlay:CMAP:LIMit:FCOLORize[:STATE]
```

### Limit Test > Use Trc Color for Limit Lines

Assigns the trace color to all limit line segments associated with the trace. All other limit line color definitions are ignored.

Remote command:

```
DISPlay:CMAP:LIMit[:STATE]
```

### General > Trace Colors per Diagram

Controls the color of traces that are moved to another diagram or created together with a new diagram. If "Trace Colors per Diagram" is disabled while different diagrams are defined, the colors of all traces become different.

The R&S ZNC/ZND assigns trace colors according to a predefined scheme, starting with the colors that are easiest to distinguish. On one hand it is advantageous to use the colors at the beginning of the scheme. On the other hand, it is often desirable to use different colors in different diagram areas so that any trace that is moved from one diagram area to another can keep its color. "Trace Colors per Diagram" changes between these two alternative color modes as shown below.

Trace Colors per Diagram	Move trace to another diagram area (Trace Manager)	Add Tr+Diag (SYSTEM > DISPLAY > Diagram)
On	Trace color changed according to the new diagram area's color scheme	Color scheme of the new diagram area is independent, restarts with the first colors. Consequently the new trace is displayed with a color that has been already used.
Off	Trace keeps its color	Color scheme of the new diagram area continues color scheme of the previously active area. The new trace is displayed with a new color.

See also program example for `DISPlay:CMAP:TRACe:COLor[:STATe]`.

Remote command:

`DISPlay:CMAP:TRACe:COLor[:STATe]`

#### General > Same Color all Markers

Selects a common marker color, which is independent of the trace colors.

Remote command:

`DISPlay:CMAP:MARKer[:STATe]`

#### General > Black White Scheme / Line Styles Scheme / Light Sheme

Modifies the user color scheme, in particular the trace and channel lines, in a predefined way. As an alternative, select predefined color schemes; see "Color Scheme" on page 326.

Remote command:

`DISPlay:CMAP<DispEl>:RGB`

#### Recall / Save

Opens standard dialogs to recall a previously saved color scheme or save the current scheme to a file. Color scheme files are non-editable files with the extension `*.ColorScheme`; the default directory is

`C:\Users\Public\Documents\Rohde-Schwarz\Vna\ColorSchemes.`

Remote command:

`MMEMory:STORe:CMAP`

`MMEMory:LOAD:CMAP`

### 4.5.5 Display > View Bar

Displays or hides information panels and bars of the graphical user interface. Hiding the information elements leaves more space for the diagrams. All elements may be shown or hidden simultaneously.

**Access:** SYSTEM > DISPLAY key or Alt + Shift + S



For a detailed description of the information elements refer to the following sections:

- [Chapter 3.2.1.4, "Menu Bar"](#), on page 22
- [Chapter 3.2.1.7, "Status Bar"](#), on page 25
- [Chapter 3.2.1.6, "Hardkey Panel"](#), on page 24
- [Chapter 3.2.1.1, "Title Bar"](#), on page 21
- [Chapter 3.2.1.2, "Toolbar"](#), on page 21

SCPI command:

```
SYSTem:DISPlay:BAR:MENU[:STATe]
```

```
SYSTem:DISPlay:BAR:STATus[:STATe]
```

```
SYSTem:DISPlay:BAR:HKEY[:STATe]
```

```
SYSTem:DISPlay:BAR:TITLe[:STATe]
```

```
SYSTem:DISPlay:BAR:TOOLs[:STATe]
```

See also: [SYSTem:DISPlay:BAR:STOOLs\[:STATe\]](#)

#### 4.5.6 Display > Touchscreen

Locks the touchscreen functionality of the R&S ZNC/ZND in order to prevent inadvertent entries.

**Access:** SYSTEM > DISPLAY key or Alt + Shift + S

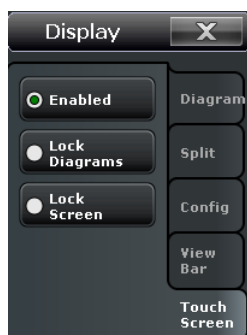

- "Enabled" – touchscreen control of the R&S ZNC/ZND fully enabled. All control elements are active.

- Lock diagrams – drag and drop functions in the diagrams are disabled, all other control elements (e.g. the softtool panels) are still active.
- Lock screen – all control elements are locked. Pressing any front panel key on the analyzer (or sending `SYSTEM:TSLock OFF`) re-enables touchscreen control.

SCPI command:

`SYSTEM:TSLock`

## 4.6 System Settings

The "System" menu provides functions which you can use to return to a defined instrument state, reverse operations, access service functions and define various system-related settings.

### 4.6.1 System > Setup > Setup

Gives access to system-related settings and service functions and selects the language of the graphical user interface.

**Access:** SYSTEM > SETUP key or Alt + Shift + T



The "Setup" buttons open the following dialogs:

- **System Config:** See [Chapter 4.6.2, "System Configuration \(Dialog\)"](#), on page 333
- **Options:** See [Chapter 4.6.3.2, "Options"](#), on page 343
- **Info:** See [Chapter 4.6.3, "Info Dialog"](#), on page 342
- **Service Function:** See [Chapter 4.6.4, "Service Function \(Dialog\)"](#), on page 344

#### Language

Selects the language of the graphical user interface. A message box indicates that the vector network analyzer application needs to be re-started to activate a different language.

English is the preinstalled language. A setup file for additional languages ("Vector Network Analyzer Translation Setup") is available for download from the [Rohde & Schwarz Internet site](#).

The setup file is identical for all analyzers of the R&S ZNx family, however it is important to choose the correct FW application type (32 or 64 bit). See "Application Type" in About-Dialog (SYSTEM > HELP > About...).

Remote command:  
n/a

**Remote Encoding**

Selects the character encoding used at the remote interface. The selected encoding applies to directory and file names, CalKit names, CalUnit characterizations and display titles.

Currently the following encodings are supported: ANSI (default), UTF-8, Shift JIS.

Remote command:  
`SYSTem:COMMunicate:CODec`

**4.6.2 System Configuration (Dialog)**

The "System Config" dialog allows to define global settings that are not affected by an instrument reset. See [Chapter 3.1.1, "Global \(Persistent\) Settings"](#), on page 11.

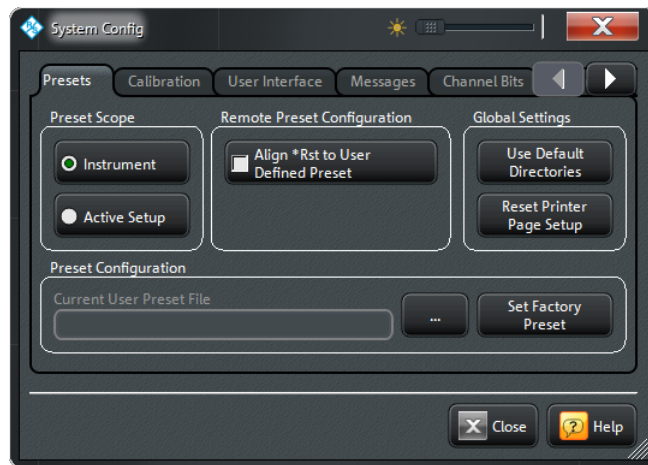

**Access:** SYSTEM > SETUP > Setup > System Config...

- [Presets](#)..... 334
- [Calibration](#)..... 334
- [User Interface](#)..... 336
- [Messages](#)..... 337
- [Channel Bits](#)..... 338
- [Advanced](#)..... 339
- [Power](#)..... 340

### 4.6.2.1 Presets

Specifies the behavior of the R&S ZNC/ZND upon a preset.

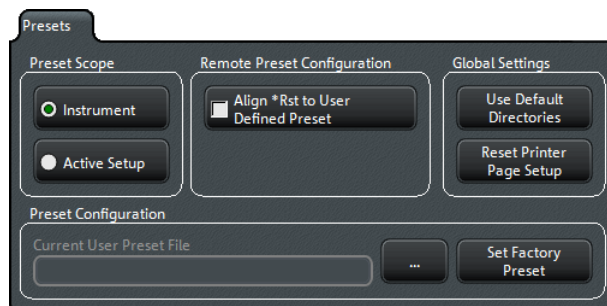

#### Preset Scope

Qualifies whether a preset affects all open recall sets ("Instrument") or the active recall set only.

Remote command:

`SYSTem:PRESet:SCOPE`

#### Remote Preset Configuration

"Align \*RST to User Defined Preset" defines the behavior of the \*RST and `SYSTem:PRESet` commands.

- **Off:** \*RST and `SYSTem:PRESet` restore the factory preset settings.
- **On:** If a valid user preset file is available, \*RST and `SYSTem:PRESet` restore the user-defined settings.

Remote command:

`SYSTem:PRESet:REMOte[:STATe]`

#### Global Settings

The two buttons reset all directory settings (e.g. the directories for storing trace data, limit lines, calibration data...) and all settings in the "Printer Setup" dialog to default values. See "Print..." on page 123.

Remote command:

n/a

#### Preset Configuration

Specifies whether "System >Preset" will perform a factory preset or restore the settings stored in a user preset file. A user preset file is an arbitrary recall set (.znx) file, to be stored using "FILE > Setup > Save...". If the current user preset file is not found (e.g. because it was deleted or moved), "System >Preset" initiates a factory preset.

Remote command:

`SYSTem:PRESet:USER:NAME`

`SYSTem:PRESet:USER[:STATe]`

### 4.6.2.2 Calibration

Provides general system error correction (calibration) settings.

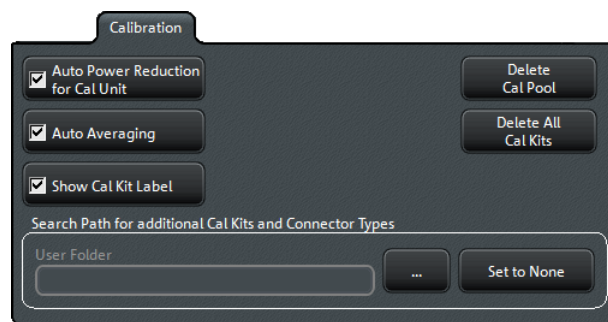

### Auto Power Reduction for Cal Unit

Sets the source power at all test ports to  $-10$  dBm while an automatic calibration is active. Applying this source power to the ports of the calibration unit ensures best accuracy of the automatic calibration. The source powers are reset to their original values after the calibration is completed. The automatic power reduction can be deactivated in case that the test setup introduces a large attenuation.

Remote command:

`SYSTem:COMMunicate:RDEvice:AKAL:PREduction[:STATe]`

### Auto Averaging

Activates automatic averaging, which means that the VNA may perform multiple calibration sweeps and apply averaging to reduce trace noise. In contrast to regular averaging (see [Chapter 4.4.1.3, "Power Bw Avg > Average"](#), on page 234) the number of calibration sweeps is calculated automatically.

Remote command:

`[SENSe:]CORrection:COLlect:AVERage`

### Show Cal Kit Label

Enables/disables the "Calibration Info" dialog during manual calibration (see ["Ports and Standards"](#) on page 266).

Independent of the state of the "Show Cal Kit" flag, cal kit labels are displayed in several other manual calibration dialogs.

### Delete Cal Pool / Delete All Cal Kits

Deletes all calibration data and all cal kit data. See [Chapter 4.4.3.18, "Calibration Manager Dialog"](#), on page 294.

Remote command:

n/a

### Search Path for Additional Cal Kits...

Contains the name and path of a special directory for cal kit files (\*.calkit). All cal kit files in the special directory will be (re-)loaded automatically as predefined kits (i.e. read-only kits which cannot be modified) every time the VNA application is started. It is possible to select the default cal kit directory

`C:\Users\Public\Documents\Rohde-Schwarz\Vna\Calibration` or any other directory. "None" means that no cal kit files are loaded on start-up.

Use the special directory to make sure that you do not have to import kits manually, even after terminating the VNA application improperly, in which case previously imported cal kit files will not be stored to the recall set file.

Remote command:

`MMEmory:LOAD:CKIT:UDIRectory`

### 4.6.2.3 User Interface

Provides general user interface configurations.

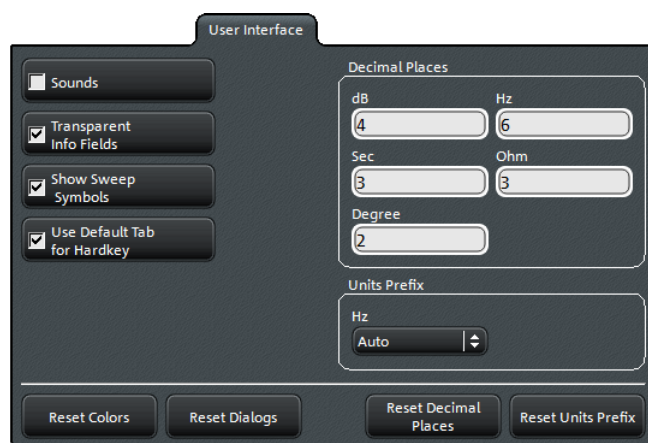

#### Instrument Messages / Sounds / Transparent Info Fields / Show Sweep Symbols

The buttons switch the instrument messages, acoustic messages, transparent info fields for markers and trace statistics, and sweep symbols on or off. Sounds are generated when the analyzer generates a notice/status message or a warning (alarm sounds) or during calibration. The sweep symbols are arrows pointing downward onto the trace; they are displayed if the sweep time exceeds a lower limit (e.g. for a large number of points or a small measurement bandwidth).

The settings are also valid if the instrument is remote-controlled. Transparent info fields do not hide an underlying trace.

Remote command:

`SYSTem:SOUNd:ALARm[:STATe]`

`SYSTem:SOUNd:STATus[:STATe]`

#### Use Default Tab for Hardkey

If the checkbox is selected, a front panel key or a button in the hardkey bar activates the first tab of the associated softtool. Otherwise the last used tab is activated.

Remote command:

n/a

#### Decimal Places

Defines the number of fractional digits for quantities with different physical units. The settings affect entries and results, e.g. the values in the marker lists.



**Note:** If your instrument is equipped with option R&S ZNC/ZND-K19, 1mHz Frequency Resolution, set "Decimal Places" of unit "Hz" to "12" in order to utilize the high frequency resolution.

Remote command:  
n/a

#### Units Prefix

Sets the unit prefix for frequencies (Base unit: Hz) to Kilo (k), Mega (M), Giga (G) or Tera (T) or lets the R&S ZNC/ZND select the appropriate prefix (Auto = default setting).

Remote command:  
n/a

#### Reset Colors / Reset Dialogs / Reset Units / Reset Units Prefix

Resets the color settings ("SYSTEM > DISPLAY > Config"), the dialog properties, the "Decimal Places" and the "Units Prefix" settings. These settings are global and not affected by an instrument preset.

Remote command:  
n/a

#### 4.6.2.4 Messages

Defines which instrument events shall be indicated by an information popup.

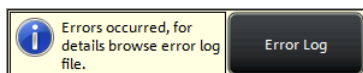

Display of information popups can be globally disabled or limited to certain event types.

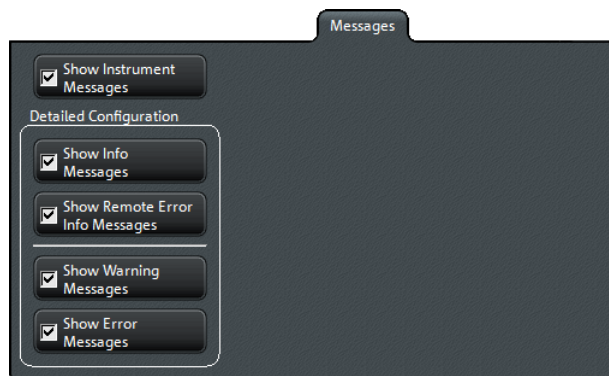

#### Show Instrument Messages

Defines whether information popups shall be displayed at all.

Remote command:  
`SYSTem:ERRor:DISPlay:STATe`

#### Show Info/Warning/Error Messages

Selectively disables/enables display of information popups for the related event type.

If information popups are globally switched off ([Show Instrument Messages](#) unchecked) these buttons are disabled. However, their checked state is memorized.

Remote command:

```
SYSTem:ERRor:DISPlay:INFO
```

```
SYSTem:ERRor:DISPlay:WARNings
```

```
SYSTem:ERRor:DISPlay:ERRor
```

### Show Remote Error Info Messages

Defines whether information popups shall be displayed whenever a remote control command error occurs.

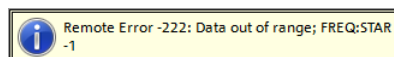

The displayed information can be useful for program development and optimization; it does not necessarily indicate that a remote control script is faulty or non-executable.

#### Note

- If either "Show Instrument Messages" or "Show Info Messages" is unchecked this button is disabled. However, its checked state is memorized.
- For SCPI error -113, `Undefined header` no tooltip is displayed

Remote command:

```
SYSTem:ERRor:DISPlay[:REMote]
```

### 4.6.2.5 Channel Bits

Sets a channel-dependent eight-bit decimal value (0 ... 255) to control eight independent output signals at the USER PORT connector (lines 8, 9, 10, 11 and lines 16, 17, 18, 19).

Setting the channel bits does not change the analyzer state.

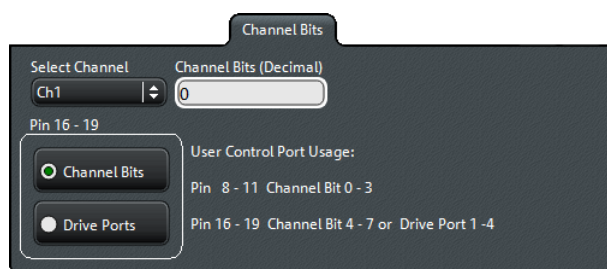

#### Channel Bits (Decimal)

Entry of the eight-bit decimal value (0 ... 255) for the selected channel. The channel bits control eight output signals at the USER PORT connector. The signals are 3.3 V TTL signals which can be used to differentiate between up to 256 independent analyzer states. For an application example refer to the description of the remote-control command.

The decimal values have the following effect:

- 0 means that no output signals are enabled at any of the pins 8, 9, 10, 11 and 16, 17, 18, 19.

- 1 enables the output signal at pin 8. The signal is switched on while the R&S ZNC/ZND performs a measurement (sweep) in the selected channel. All other signals are inactive.
- 2 enables the output signal at pin 9.
- 3 enables the output signals at pins 8 and 9.
- ...
- 255 enables the output signals at all pins. See also "Pin 16 - 19" on page 339.

Remote command:

`OUTPut<Ch>:UPORt[:VALue]`

#### Pin 16 - 19

Selects the control mechanism for the signals at pins 16, 17, 18, 19 of the USER PORT connector.

- **Channel Bits:** Signals are controlled by channel bits 4 to 7. No drive port indication at the USER PORT connector.
- **Drive Ports:** Signals indicate the active drive ports. The number of active channel bits is reduced to 4 (pins 8, 9, 10, 11).

Remote command:

`OUTPut:UPORt:ECBits`

#### 4.6.2.6 Advanced

Collects several advanced settings.

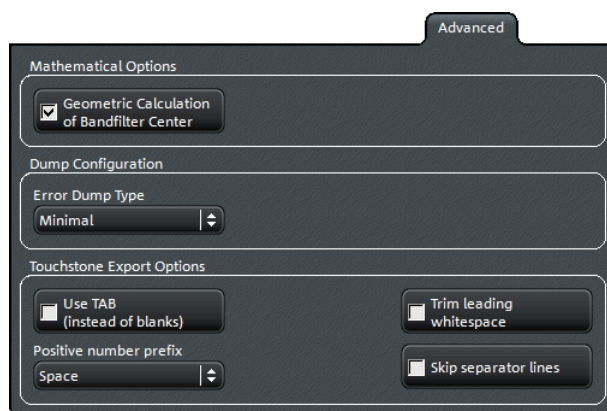

#### Geometric Calculation of Bandfilter Center

Defines how bandfilter searches calculate the center frequency of the passband or stopband (see "Bandfilter Search" on page 34).

If "Geometric Calculation of Bandfilter Center" is checked, the *geometric mean* of the lower band edge and upper band edge frequencies is used, otherwise their *arithmetic mean*.

Remote command:

`CALCulate:MARKer:FUNCTion:BWIDth:GMCenter`

### Error Dump Type

Determines the level of detail ("Minimal", "Normal", "Large", "Full") and hence the size of the dump files created in case of firmware exceptions. "None" disables dump file creation.

The latest 5 exception dumps can be retrieved using the "Save Report" function of the "Info" dialog (see ["Save... / Print... / Save Report"](#) on page 342).

For further information see [Chapter 8, "Error Messages and Troubleshooting"](#), on page 798.

Remote command:

```
DIAGnostic:DUMP:SIZE
```

### Touchstone Export Options

Configures whitespace insertion during Touchstone file export.

The default export format is explained in chapter [Chapter 3.4.2.1, "Touchstone Files"](#), on page 69:

- logical columns are vertically aligned using spaces
- positive and negative numbers are vertically aligned by prefixing positive numbers with blanks
- the frequencies are horizontally separated from the corresponding S matrices using leading spaces
- the content parts (header, S matrices for different frequencies) are separated by blank lines

### Use TAB (instead of blanks) ← Touchstone Export Options

If checked, columns are separated by tabs rather than spaces.

Remote command:

```
MMEMory:STORe:TRACe:OPTion:TABS
```

### Trim leading whitespace ← Touchstone Export Options

If checked, whitespace at the beginning of each line is removed

Remote command:

```
MMEMory:STORe:TRACe:OPTion:TRIM
```

### Positive number prefix ← Touchstone Export Options

Positive numbers can either be prefixed by blanks, by plus signs or not at all

Remote command:

```
MMEMory:STORe:TRACe:OPTion:PLUS
```

### Skip separator lines ← Touchstone Export Options

If checked, the content parts are no longer separated by blank lines

Remote command:

```
MMEMory:STORe:TRACe:OPTion:SSEPARATOR
```

## 4.6.2.7 Power

The settings in this tab define how the VNA sets the output power between sweeps. This applies to all sweep modes but is particularly useful in single sweep mode.

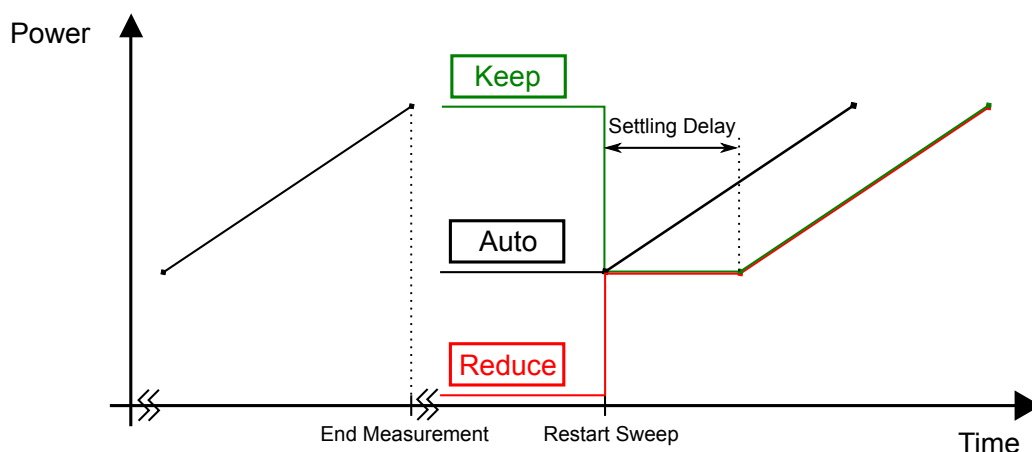
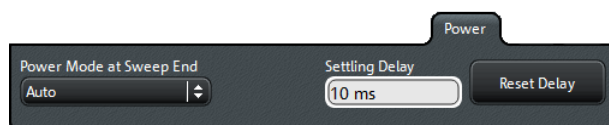

Figure 4-15: Power control at sweep end in Single Sweep mode (power sweep)



By default, at sweep end the output power of the first measurement point is restored ("Auto" mode). After a small settling time (~10 ms) the sweep can be restarted.

Selecting a different behavior may result in a significantly longer total measurement time, in particular if a long "Settling Delay" is used. Don't forget to revert the [Power Mode at Sweep End](#) to "Auto" mode if is not necessary to "Reduce" or "Keep" the power at the sweep end. A PRESET is not sufficient for this purpose!



### Power Mode at Sweep End

The analyzer offers three power modes at sweep end:

- "Auto" results in the shortest measurement time (default setting). If enabled, at sweep end the output power of the first measurement point is restored. The configured [Settling Delay](#) is not applied.
- "Reduce" is intended for measurements on sensitive DUTs (primarily: power sweeps). If enabled, at sweep end the output power of the driving port is reduced as if the channel base power was set to its minimum possible value. The configured settling delay is applied.
- "Keep" is intended for power sweeps. If enabled, at sweep end the output power of the last measurement point is kept. The configured settling delay is applied.

See [Figure 4-15](#) for an illustration.

#### Note:

- Compared to "Auto" mode, "Reduce" and "Keep" may result in significantly longer measurement times - in particular if an extended settling delay is used.
- The output power is not altered if there's only a single channel with a single driving port, performing a Time or CW Mode sweep.
- In triggered mode the analyzer always uses the settings of the first measurement point while waiting for the trigger signal.

Remote command:

[SOURce<Ch>:POWer<PhyPt>:SWEpend:MODE](#) on page 705

### Settling Delay / Reset Delay

If [Power Mode at Sweep End](#) is set to "Reduce" or "Keep", the "Settling Delay" defines the time between [Restart Sweep](#) request and sweep start. See [Figure 4-15](#) for an illustration.

Use the "Reset Delay" button to adjust the "Settling Delay" to its default value.

Remote command:

[SOURce<Ch>:POWer<PhyPt>:SWEpend:SDELay](#) on page 705

## 4.6.3 Info Dialog

The "Info" dialog displays information about the instrument and its operation. All functions are primarily intended for error diagnostic and service purposes; see [Chapter 8.1.3, "Obtaining Technical Support"](#), on page 800. Many "Info" tabs also display softkeys for printing the contents or saving them to a file.

**Access:** SYSTEM > SETUP > Setup > Info...

### 4.6.3.1 Setup

Displays the channel and trace settings of the active recall set and the main characteristics of the instrument including its IP address.

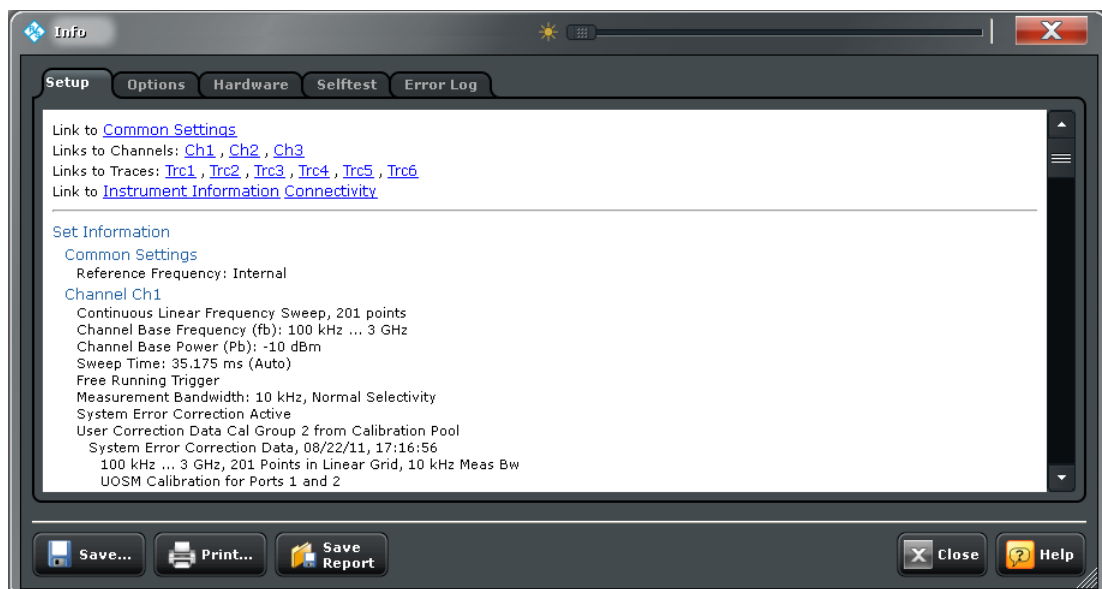

### Save... / Print... / Save Report

The buttons across the bottom of the the "Info" dialog save the contents of the open tab to a file or create a hardcopy. "Save Report" saves the current selftest results to a zipped report file which you may send in for fault diagnosis; see [Chapter 8.1.3, "Obtaining Technical Support"](#), on page 800.

Remote command:

```
DIAGnostic:DEVIce:STATe
SYSTem:DFPRint?
```

#### 4.6.3.2 Options

Shows the installed software and hardware options. You can also enable additional software options using the option key supplied with the option. Proceed according to the instructions in the dialog.

For an overview of options refer to [Chapter 3.7, "Optional Extensions and Accessories"](#), on page 109.

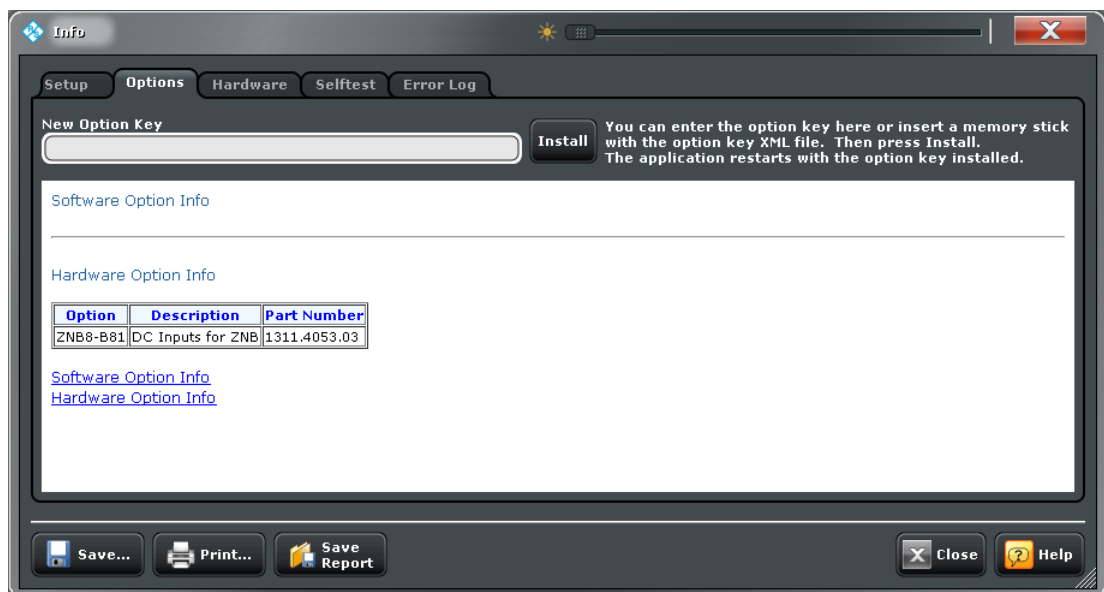

#### Software Option Info

Software options are listed with their name and description, the option key and key type, and the activation and expiration date (if applicable).

Remote command:

```
DIAGnostic:PRODUct:OPTion:INFO?
```

#### 4.6.3.3 Hardware

Gives an overview of the analyzer's hardware configuration and basic hardware-related instrument settings.

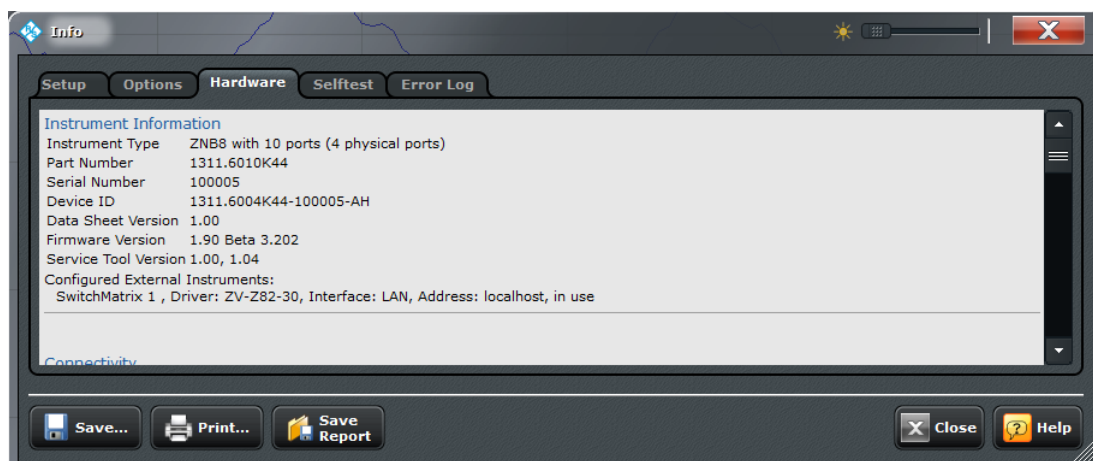

#### 4.6.3.4 Selftest

Displays the result of the automatic selftest of the analyzer.

#### 4.6.3.5 Error Log

Contains a chronological record of errors that occurred in the current and in previous sessions. While the error log is open, additional buttons for printing, closing or clearing (delete) the log are provided. The deleted error log shows the message "No errors found".

### 4.6.4 Service Function (Dialog)

The "Service Function" dialog gives access to the service functions of the instrument. Most of the service functions require a service level > 0 that is protected by a password. Those service functions should be used by a Rohde & Schwarz service representative only. Refer to the service manual for more information.

**Access:** SYSTEM > SETUP > Setup > Service Function...

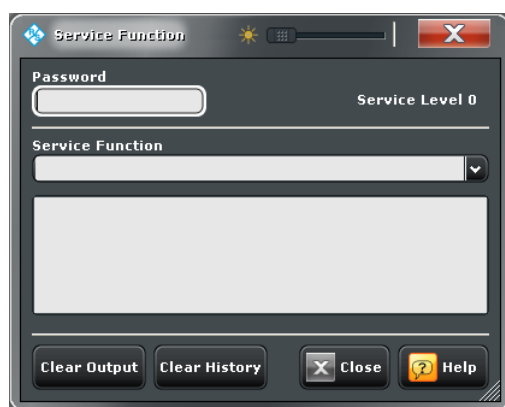



**Password**

Enter a password here to activate the required service level.

Remote command:

`SYSTem:PASSword[:CENable]`

**Service Function**

Identifier of the service function in "dotted textual" (example: sw.common.memory\_usage) or "dotted decimal" (example: 0.1.18.0) representation.

Remote command:

`DIAGnostic:SERvice:SFUNction`

**4.6.5 System > Setup > Freq. Ref.**

Selects a reference signal for synchronization between the R&S ZNC/ZND and external devices. A common reference frequency is generally advisable to ensure frequency accuracy and frequency stability in the test setup.

**Access:** SYSTEM > SETUP key or Alt + Shift + T

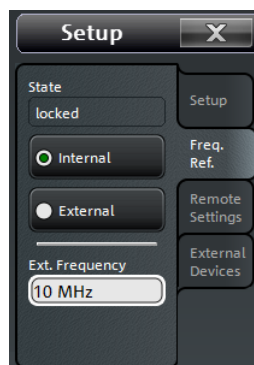
**State**

Indicates the state of the internal phase locked loop: If the frequencies are properly synchronized, the state is "locked".

Remote command:

n/a

**Internal / External**

Selects the internal or an external reference clock signal for synchronization.

- **Internal:** The analyzer provides a 10 MHz internal reference clock signal which can be tapped off at the REF OUT connector at the rear of the instrument in order to synchronize other devices, e.g. signal generators or a second R&S ZNC/ZND network analyzer.
- **External:** The external reference clock signal must be applied to the REF IN connector at the rear of the instrument. The external reference signal must meet the specifications of the data sheet; its frequency must be specified in the "Ext Frequency" field. The internal reference signal is synchronized to the external signal. The external signal is also looped to REF OUT, so that it can be re-used to synchronize other devices.

Remote command:

[SENSe<Ch>:]ROSCillator[:SOURce]

### Ext Frequency

Specifies the frequency of the external reference clock signal at REF IN.

Remote command:

[SENSe<Ch>:]ROSCillator:EXTernal:FREquency

## 4.6.6 System > Setup > Remote Settings

Configures the remote control interfaces of the R&S ZNC/ZND.

**Access:** SYSTEM > SETUP key or Alt + Shift + T

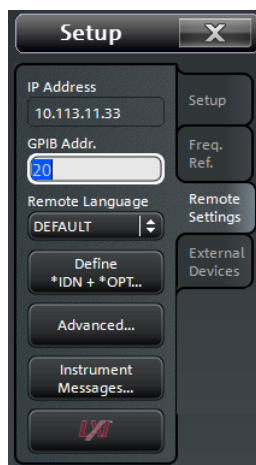

### IP Address

Displays the current IP address of the R&S ZNC/ZND. By default, the analyzer is configured to use dynamic TCP/IP configuration (DHCP) and obtain all IP address information automatically. See chapter "Assigning an IP Address" in the Help or in the Getting Started guide.

Remote command:

n/a

### GPiB Address

Defines the analyzer's GPiB address. The address must be in the range between 0 and 30.

Remote command:

SYSTem:COMMunicate:GPiB[:SELF]:ADDRes

### Remote Language

Selects the syntax of the R&S ZNC/ZND's instrument control commands.

- The DEFAULT language corresponds to the commands reported in this documentation; see [Chapter 6.3, "SCPI Command Reference"](#), on page 401.
- The ZVABT language ensures compatibility with network analyzers of the R&S ZVA/B/T family. E.g. compared to the DEFAULT language, the command set does

not include `INITiate:CONTinuous:ALL` and `INITiate[:IMMediate]:ALL`.

The function of `INITiate:CONTinuous` and

`INITiate[:IMMediate][:DUMMy]` is modified; refer to the remote control documentation in [Chapter 6.3.9, "INITiate Commands"](#), on page 540.

- The ZVR language ensures compatibility with network analyzers of the R&S ZVR family. See also [Chapter 6.4, "R&S ZVR/ZVAB Compatible Commands"](#), on page 744.
- PNA, ENA, HP8510, HP8720, HP8753 ... denote command sets for network analyzers from other instruments or manufacturers.

**Note:** Remote Language settings other than DEFAULT are intended for remote control of the analyzer. A mixed approach, with part of the instrument configuration defined via the GUI, is possible but may cause unexpected results in some instances.

Remote command:

`SYSTem:LANGuage`

### Define \*IDN? + \*OPT?

Defines a format for the ID string and the option string of the analyzer. The default strings are automatically adjusted to the selected "Remote Language". The strings can be queried via `*IDN?` and `*OPT?`, respectively.

- If the DEFAULT language is activated, the factory ID string "Rohde&Schwarz,ZNC<Max. Freq>-<Ports>Port,<Serial\_no>,<FW\_Version> (e.g. Rohde-Schwarz,ZNC8-2Port,131160042100005,1.10.05)" is set. The option string is a comma-separated list of all installed software and hardware options. The bit order for transferred binary data is swapped (`FORMat:BORDER SWAPPed`).
- If the PNA language is activated, Agilent-compatible ID and option strings are set. The bit order for transferred binary data is normal.
- If one of the HP xxxx languages is activated, HP xxxx-compatible ID and option strings are set. Binary data is transferred in a device-specific bit order, however, the bit order can be changed using HP xxxx-specific commands.

The ID and option strings can be changed or reset to the R&S factory ID string.

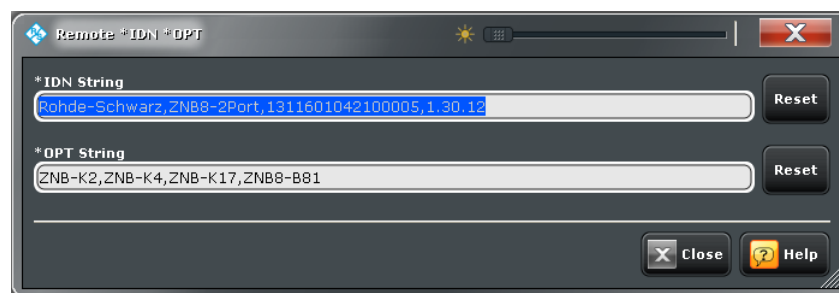

Remote command:

`SYSTem:IDENtify[:STRing]`

`SYSTem:IDENtify:FACTory`

`SYSTem:OPTions[:STRing]`

`SYSTem:OPTions:FACTory`

`FORMat:BORDER`

**Advanced**

Opens a dialog that allows to set the following parameters:

- "Wait for Data after Sweep" determines the execution behavior of `INITiate[:IMMEDIATE]` commands (see [Chapter 6.3.9, "INITiate Commands"](#), on page 540).  
If enabled, an automatic `*WAI` is added (see [Chapter 6.2, "Common Commands"](#), on page 400).  
By default this is disabled.
- "Auto-Align Logical Ports" determines the logical port creation logic.  
If enabled (default), logical ports are aligned and must be set from low to high port (which was the only possibility prior to firmware V1.91). If set to disabled, new ports can be created freely, like in manual operation.



Remote command:

```
SYSTEM:COMMunicate:GPIB[:SELF]:INIT:WAIT
SYSTEM:COMMunicate:GPIB[:SELF]:LPORt:ALIGn
```

**Instrument Messages ...**

Opens the System Configuration dialog with the [Messages](#) tab selected. From there you can configure the display of instrument messages as information popups, in particular the display of remote control command errors.

**4.6.7 Remote LXI (Dialog)**

The "Remote LXI" dialog provides basic LXI functions for the analyzer and displays IP and MAC address information.

**Background information**

Refer to the following sections:

- [Chapter 5.6, "LXI Configuration"](#), on page 392
- [Chapter 5.6.2, "LXI Browser Interface"](#), on page 393

**Access:** SYSTEM > SETUP > Remote Settings > LXI...



### LAN Config Initialize

Initiates the network configuration reset mechanism (LCI) for the R&S ZNC/ZND. According to the LXI standard, an LCI must place the following parameters to a default state.

Parameter	Value
TCP/IP Mode	DHCP + Auto IP Address
Dynamic DNS	Enabled
ICMP Ping	Enabled
Password for LAN configuration	LxiWebIfc

The LCI for the network analyzer also resets the following parameters:

Parameter	Value
Hostname	<Instrument-specific host name>
Description	Vector Network Analyzer
Negotiation	Auto Detect
VXI-11 Discovery	Enabled

The LAN settings are configured in the browser interface; see [Chapter 5.6.2, "LXI Browser Interface"](#), on page 393.

Remote command:

n/a

### LXI Status Enabled

Switches the LXI logo in the status bar on or off.



Remote command:

n/a

## 4.6.8 System > Setup > External Devices

Allows to set up and configure external power meters and calibration units and to enable error logging for the current session.



### Background information

Refer to the following sections:

- [Chapter 3.7.11, "External Power Meters"](#), on page 117
- [Chapter 3.5.5, "Automatic Calibration"](#), on page 91



### Persistent vs. session settings

The settings in the "Setup" panel and the configuration dialogs are global settings and not affected by a "Preset" of the analyzer. The external device configuration persists even after the analyzer is turned off. Error logging is turned off whenever a measurement session is closed. See also [Chapter 3.1.1, "Global \(Persistent\) Settings"](#), on page 11.

**Access:** SYSTEM > SETUP key or Alt + Shift + T



The buttons in the "External Devices" panel open the following dialogs:

- **Power Meters:** See [Chapter 4.6.9, "External Power Meters \(Dialog\)"](#), on page 351
- **Power Meter Config:** See [Chapter 4.6.10, "External Power Meter Config \(Dialog\)"](#), on page 354

This button is active only if at least one external power meter is online (physically connected, switched on, ready to be used).



### USB-to-IEC/IEEE adapter, VISA

To control external devices equipped with a GPIB interface (but not with a USB interface) you can use the USB-to-IEC/IEEE Adapter (option R&S ZVAB-B44, order no. 1302.5544.03). Option R&S ZVAB-B44 consists of an adapter and a driver software. The driver software is installed on the network analyzer. Connect the USB port of the adapter to any of the master USB connectors on the front or rear panel of the analyzer. Connect the GPIB port of the adapter to the external device.

An appropriate Virtual Instrument Software Architecture (VISA) library which is needed to control external devices via LAN, GPIB, or USB interface is part of the VNA firmware.

### Log Errors

Enables the transfer of error messages for external devices (e.g. connection errors) to the error log. The error log appears in the "Info" dialog; see [Chapter 4.6.3, "Info Dialog"](#), on page 342.

Remote command:  
n/a

## 4.6.9 External Power Meters (Dialog)

The "External Power Meters" dialog configures external power meters so that they can be used for measurements and power calibrations.



### Background information

Refer to section [Chapter 3.7.11, "External Power Meters"](#), on page 117.

**Access:** SYSTEM > SETUP > External Devices > Power Meters...

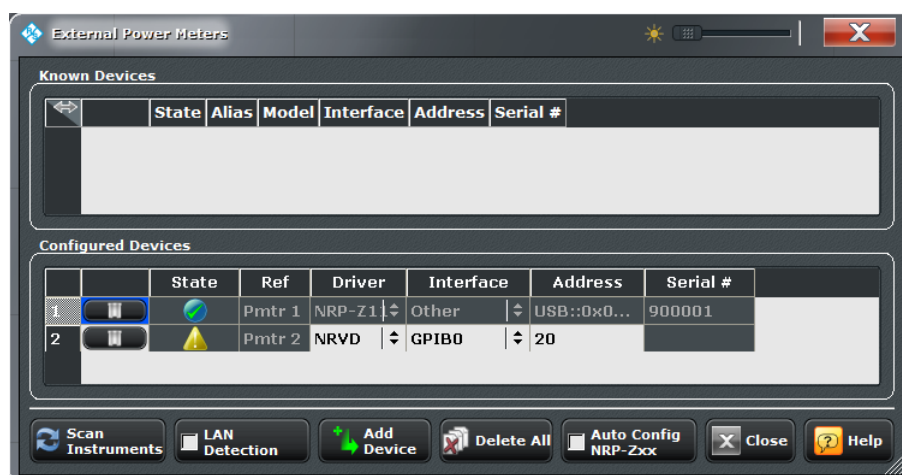

The configuration of a new external power meter involves the following steps:

1. connect the power meter to your R&S ZNC/ZND using a LAN (VXI-11), GPIB, or USB interface.
2. If the power meter is connected via LAN, enable "LAN detection"
3. tap "Scan Instruments" and wait until the power meter appears in the table of "Known Devices".
4. tap  to copy the power meter into the list of configured devices.

If the R&S ZNC/ZND fails to detect a connected power meter,

- ▶ tap "Add Device" to define the interface type and address.

The R&S ZNC/ZND can auto-detect the instrument type (driver) and the serial number of the connected power meter.



To control external devices via GPIB, the pre-installed RS Visa library (`visa32.dll`) must be replaced by the **NI Visa** library.

### Known Devices

Table with all power meters that the analyzer detects to be on line (i.e. connected and switched on). "Scan Instruments" refreshes the table;  copies a detected instrument to the table of "Configured Devices".

To appear in the table of "Known Devices", power meters (except the USB sensors R&S NRT-Zxx) must have been configured previously. See also [Configured Devices](#).



Remote command:

n/a

### Configured Devices

Table with all power meters in use with their properties. The properties of manually configured power meters ("Add Device") may be changed in the dialog.

The following symbols (greyed out for *used* devices) indicate the status of the respective device:

-  – The device is online (connected, switched on, ready to be used).
-  – This state can be caused by different problems:
  - General communication error  
In this case, check whether the device is properly connected to the configured interface.
  - Self test error  
In this case enable error logging for external devices (see "[Log Errors](#)" on page 351), and search the [Error Log](#) for self test error codes of the device.
-  – The device driver doesn't match exactly the device type. Probably the device cannot be controlled properly. Measurements results are questionable.

Remote command:

`SYSTEM:COMMunicate:RDEVICE:PMETER<Pmtr>:DEFine`

`SYSTEM:COMMunicate:RDEVICE:PMETER:DELete`



`SYSTEM:COMMunicate:RDEvice:PMETer<Pmtr>:CATalog?`

`SYSTEM:COMMunicate:RDEvice:PMETer:COUNT?`

### Scan Instruments

Performs an autodetection of "Known Devices" on the supported interfaces.

**Note:** Unintentional switchover to remote control

When using the NI-VISA library, ensure that the network analyzer itself is not listed as a network device in the Measurement & Automation Explorer. Otherwise, "Scan Instruments" will send an identification query (\*IDN?), causing the analyzer to close the "External Power Meters" dialog (without executing "Scan Instruments") and to activate the remote screen.

Remote command:

n/a

### LAN Detection

Activate "LAN Detection" to include the LAN interface in the autodetection sequence (see [Scan Instruments](#)).

**Note:** "LAN detection" will only work for external devices sharing the same IP subnet with the R&S ZNC/ZND.

As a prerequisite, the R&S ZNC/ZND must accept incoming connections on UDP port 2473. If necessary, add a corresponding inbound rule to your firewall settings.

Remote command:

n/a

### Add Device

Adds a new instrument to the list of "Configured Devices". In the "Add External Power Meter" dialog, you can specify the instrument and connection properties:

- "Interface" selects an interface/protocol type for the connection. In addition to the GPIB, VXI-11 and SOCKET interface types (for devices connected to the GPIB Bus or LAN connectors on the rear panel of the analyzer, respectively; see [Table 4-3](#)), the analyzer supports any "Other" interface supported by the installed VISA library. "Other" is used in particular for USB connections, e.g. for auto-detected R&S NRP-Zxx sensors.
- "Address" contains the address for the current interface type. GPIB addresses must be unique for all devices connected to the GPIB bus (range: 0 to 30), GPIB and IP addresses must agree with the entries in the VISA library. The remaining interface types require composite address formats; see [Table 4-3](#).  
If an instrument is connected to the R&S ZNC/ZND, the entries in the DRIVER FOR NEW INSTRUMENT panel can be auto-detected for the specified interface type and address.
- "Identify" sends an identification query ("IDN?") to the specified device address in order to identify the type and serial number of the connected power meter and select an appropriate driver file. Power meter driver files (\*.pwm) are stored in the `Resources\ExtDev` subdirectory of the analyzer's program directory.

Table 4-3: Interface types for external power meters and address formats

Physical interface (connector)	Interface (protocol)	Address	Remarks
LAN	VXI-11	<IpAddress> e.g. 127.0.0.0	Full VISA resource string: TCPIP[board]::<Address>[::INSTR]
	SOCKET	<IpAddress>::<PortNo> e.g.127.0.0.0::50000	LAN connection with pure TCP/IP protocol; refer to your VISA user documentation.
GPIB	GPIB0 ... GPIB9	<Address> e.g. 20	Full VISA resource string: GPIB[board]::<Address>[::INSTR]
LAN or USB	Other	Interface-specific, e.g. for SOCKET: TCPIP0::<IpAddress>::<PortNo>::SOCKET	Use complete VISA resource string.

Remote command:

```
SYSTem:COMMUnicate:RDEvice:PMETer<Pmtr>:DEFine
```

#### Auto Config NRP-Zxx

Causes the analyzer to clear the lists of "Known Devices" and "Configured Devices" and automatically configure all NRP-Zxx power meters detected at any of the USB ports as Pmtr 1, Pmtr 2... No manual configuration is required.

Remote command:

```
SYSTem:COMMUnicate:RDEvice:PMETer:CONFIgure:AUTO[:STATe]
```

### 4.6.10 External Power Meter Config (Dialog)

Allows to modify configuration of certain external power meters, i.e. settings that are persistently stored on the power meter (and NOT on the R&S ZNC/ZND). This requires the respective device to be online, i.e. connected, switched on and ready to be used.

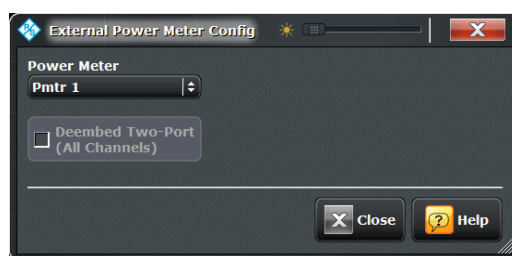

#### Deembed Two-Port (All Channels)

Reads and modifies the state of the built-in S-parameter correction that is available on certain R&S®NRP-Z power sensors. See Application Note [1GP70: Using S-Parameters with R&S®NRP-Z Power Sensors](#) for background information.

Remote command:

```
SYSTem:COMMUnicate:RDEvice:PMETer<Pmtr>:SPCorrecTion[:STATe]
```

### 4.6.11 System > Print

Prints the active setup (i.e. the contents of the active diagrams) to an external printer, to a file or to the clipboard. The settings are identical with the "File > Print" settings; see [Chapter 4.1.3, "File > Print"](#), on page 123.

### 4.6.12 Additional System Functions

The "System" menu also provides the "Preset", "Undo", and "Redo" functions. These functions are not included in the "System" softtool panels; they are accessible via hard-keys in the SYSTEM panel.

#### Preset

Performs a preset of all instrument settings or of the active recall set, depending on the settings in the "Presets" tab of the "SYSTEM > SETUP > Setup > System Config" dialog. See [Chapter 4.6.2.1, "Presets"](#), on page 334.

A preset may be a factory preset or a user-defined preset. It does not change e.g. the data related to global resources (e.g. cal pool, cal kit data), the position of dialogs, the color scheme of the diagrams, and the directory and printer settings. Many of these properties can be reset in the "System Config" dialog.

**Tip:** If you activate "Preset" by mistake, you can tap the "Undo" button in order to restore your previous instrument settings.

Remote command:

```
*RST
```

```
SYSTem:PRESet:SCOPE
```

```
SYSTem:PRESet:USER:NAME
```

```
SYSTem:PRESet:USER[:STATe]
```

```
SYSTem:PRESet[:DUMMy]
```

#### Undo and Redo buttons

"Undo" reverses the last action, if possible. Otherwise, the "Undo" button is disabled (grayed). "Redo" reverses the action of the "Undo" command. If "Undo" has not been used before, "Redo" is disabled (grayed).



"Undo" and "Redo" are disabled if the size of the active recall set file exceeds 1 MB.

**Tip:** You can also use "Undo" after a "Preset", in order to restore your old instrument settings.

## 4.7 Applic Menu

The "Applic(ation)" menu gives access to applications and tools that extend the functionality of the analyzer firmware.

### 4.7.1 Applic > External Tools

Gives access to pre-installed and user-defined external tools.

**Access:** APPLIC key or "Application > External Tools" menu



#### GPiB Explorer

Opens a tool that allows you to connect to the analyzer, obtain an overview of all implemented remote control programs, test programs, compile and run test scripts. For a detailed description refer to [Chapter 5.1.2, "GPiB Explorer"](#), on page 360.

#### Protocol Wordpad

Convenience function for opening the WordPad word processor.

This may be used for creating ad hoc measurement protocols, reports etc.

#### Tool 3 ... Tool 8

Allows you to add your own external tools. Any new shortcut in the

C:\Users\Public\Documents\Rohde-Schwarz\Vna\External Tools directory will replace one of the buttons.

#### Title and Bar Task Bar On

Displays or hides the title bar and the task bar across the bottom of the screen. Typically you can use the task bar to change between the VNA application and other external tools. See also [Chapter 3.2.1.1, "Title Bar"](#), on page 21.

#### Screen Keyboard

Opens the Windows "On-Screen Keyboard". This tool allows you to enter characters, in particular letters, if an input field cannot call up the analyzer's own on-screen keyboard, and if no external keyboard is connected.

**Windows Explorer**

Opens the Windows Explorer and shows you the contents of the  
 C:\Users\Public\Documents\Rohde-Schwarz\Vna\External Tools application shortcut directory.

## 4.8 Help Menu

The "Help" menu provides assistance with the network analyzer and its operation.

**Access:** SYSTEM > HELP key or Help menu

**Contents... / Index...**

Opens the "Contents" or the "Index" page of the help system.

**About...**

Opens a dialog to retrieve information about the network analyzer and the current firmware version.

## 4.9 Control Menu

The control icon  in the title bar provides standard Windows® functions to control the main application window. To access this icon the "Title Bar" must be open.

Double-clicking a control icon is the same as clicking the  icon or the "Close" menu command.

**Restore**

Returns the maximized or minimized active window to its size and position. "Restore" is available after a "Maximize" or "Minimize" command only.

**Move**

Displays a four-headed arrow to move the active window with the arrow keys or with the mouse. This command is unavailable for maximized windows.

**Size**

Displays a four-headed arrow to change the size of the active window using the arrow keys or the mouse.

**Minimize**

Reduces the active window to an icon.

**Maximize**

Enlarges the active window to fill the available space.

**Close**

Ends the analyzer session.

**Note:** The "Close" application command is equivalent to the "Exit" command in the "File" menu. Moreover "Close" has the same effect as a tap and hold on the "Control" menu icon or a tap and hold on the  icon in the title bar of the active window.

## 5 Remote Control

This chapter provides instructions on how to set up the analyzer for remote control, a general introduction to remote control of programmable instruments, and the description of the analyzer's remote control concept. For reference information about all remote control commands implemented by the instrument, complemented by comprehensive program examples, refer to [Chapter 6, "Command Reference"](#), on page 398.

### 5.1 Introduction to Remote Control

The instrument is equipped with different interfaces for remote control:

- A GPIB bus interface according to standard IEC 625.1/IEEE 488.1. The GPIB bus connector for control of the analyzer from a controller is located on the rear panel of the instrument.
- Analyzers connected to a Local Area Network can be controlled via the RSIB, VXI-11, or HiSLIP protocols. Two connectors for LAN connection are located on the rear panel. A VISA installation on the **controller** is required.
- The network analyzer can itself act as a master and control external power meters via LAN, USB, or GPIB interface.

A VISA installation on the **analyzer** is a prerequisite for this remote control type. The Virtual Instrument Software Architecture (VISA) library is included in the VNA firmware.



#### Visa library

VISA is a standardized software interface library providing input and output functions to communicate with instruments. The I/O channel (LAN or TCP/IP, USB...) is selected at initialization time by means of the channel-specific resource string (also termed address string) or by an appropriately defined VISA alias (short name). A VISA installation on the master device is a prerequisite for remote control over LAN interface and for control of external devices from the analyzer.

To control external devices via USB, the "IVI Visa Shared Components" must be installed in addition. You can easily perform the installation from the "Start" menu of your analyzer.

To control external devices via GPIB, the pre-installed RS Visa library (`visa32.dll`) must be replaced by the **NI Visa** library.

For more information about VISA refer to the user documentation.

---



### HiSLIP protocol

The HiSLIP (High Speed LAN Instrument Protocol) is a protocol for TCP-based instruments specified by the IVI foundation. Compared to its predecessor VXI-11, it provides speed and other improvements. HiSLIP is encapsulated in VISA; the resource string reads `TCPIP::<R&S#x00a0;ZNC/ZND IP address>:hislip0`.

The internal VISA library of the R&S ZNC/ZND supports HiSLIP. If the connection fails, access the Windows control panel of the controlled instrument and open port 4880 for incoming connections.

## 5.1.1 Starting a Remote Control Session

A remote control program must open a connection to the analyzer (using VISA functionality), before it can send commands to the analyzer and receive device responses (e.g. measurement data). The programming details depend on the library version used and on the programming language. For this reason, the examples in chapters "Command Reference" and "Programming Examples" are reduced to the mere SCPI syntax.

Example controller programs may be obtained from the Rohde & Schwarz support centers. In many cases, it can be preferable to integrate the controller program into post-processing tools (e.g. Microsoft Excel) in order to list, draw, or manipulate the measured values retrieved from the analyzer.

The following tools can make remote control more comfortable and faster:

- Various software tools provide an easy-to-use graphical user interface for remote control. An example is the "GPIB Explorer" (also termed "IECWIN32") which is pre-installed on the analyzer. See [Chapter 5.1.2, "GPIB Explorer"](#), on page 360.
- Instrument drivers provide an improved interface between the test software and the test instruments. They perform the actual control of the instrument using higher-level functions for operations such as configuring, reading from, writing to, and triggering the instrument. This reduces development time, eliminating the need to learn the specific command set for each instrument. In general, program development is further simplified by a graphical program environment.

Rohde & Schwarz offers various R&S ZNC/ZND driver types (LabView, LabWindows/CVI, IVI, VXIplug&play...) for different programming languages. The drivers are available free of charge on the product pages in the R&S internet, along with installation information.

## 5.1.2 GPIB Explorer

The GPIB Explorer is a software tool that allows you to connect to the analyzer, obtain an overview of all implemented remote control programs, test programs, compile and run test scripts. The program can be opened from the Windows® start menu: "Programs – R&S Network Analyzer – GPIB Explorer" or via "APPLIC > External Tools > GPIB Explorer". You can also start the executable file `iecwin32.exe` in the program directory of the network analyzer (e.g.

`C:\Program Files\Rohde&Schwarz\Network Analyzer\Bin`).



After the GPIB Explorer is started, the interface and protocol for the connection to the instrument can be selected in a dialog:

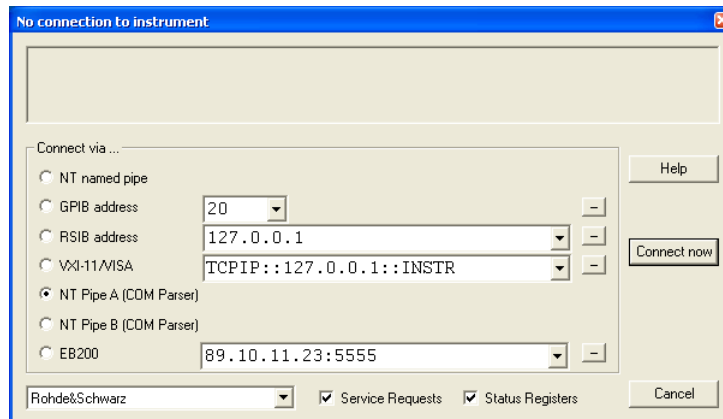

The following options are provided:

- **NT named pipe** (not supported at present)
- **GPIB address** (for connection to controllers equipped with a National Instruments GPIB interface using the GPIB bus connector)
- **RSIB address** and **VXI-11/VISA** (for LAN connection, requires an appropriate IP or local host address); see chapter "Remote Operation in a LAN" in the Help or in the Getting Started guide.
- **NT pipe A/B (COM Parser)** (only for a GPIB Explorer installed on the analyzer, recommended for "remote" test on the instrument)
- **EB200** (not supported at present)



Select "SETUP > Setup > Info..." to look up the IP address information of your analyzer. If you run the GPIB explorer on the analyzer, the local host address (loopback address) is 127.0.0.1.

After the connection is established, the GPIB explorer displays a tree view of all commands included in the current firmware version of the network analyzer. The programs can be selected for execution by a single mouse click.

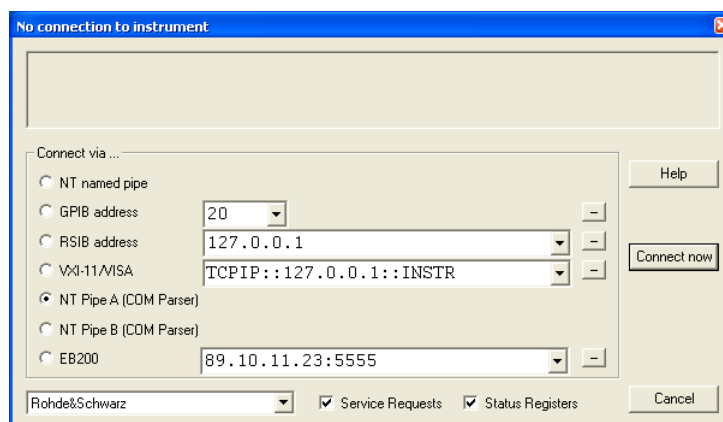



It remote logging is enabled (SYSTem:LOGGing:REMOte[:STATE] ON) the analyzer stores all received commands to the file

'C:\Users\Public\Documents\Rohde-Schwarz\Vna\RemoteLog'.

### 5.1.3 Switchover to Remote Control

On power-up, the instrument is always in the manual operating state and can be operated via the front panel controls. The instrument is switched to remote control as soon as it receives a command from the controller. If the instrument is controlled via RSIB or VXI-11 protocol, the alternative commands @REM and @LOC can be used to switch from manual to remote control and back.

While remote control is active, operation via the front panel is disabled with the exception of the "Remote" softtool panel. The instrument settings are optimized for maximum measurement speed; the display is switched off:



The softkeys in the remote screen are used to modify or quit the remote state:

- "Go to Local" switches the instrument to local state.
- "Display" switches the display on or off.
- If a remote error message is displayed at the bottom of the remote screen, you can use "Clear Error Messages" to delete it.

The remaining controls are for future extensions.

#### Display on and off states

Switching on the display means that the analyzer shows the measurement screen with the current recall sets, diagram areas and traces without leaving the remote state. In this operating mode, it is possible to observe the screen while a remote control script is executed and the control elements on the front panel are still disabled.

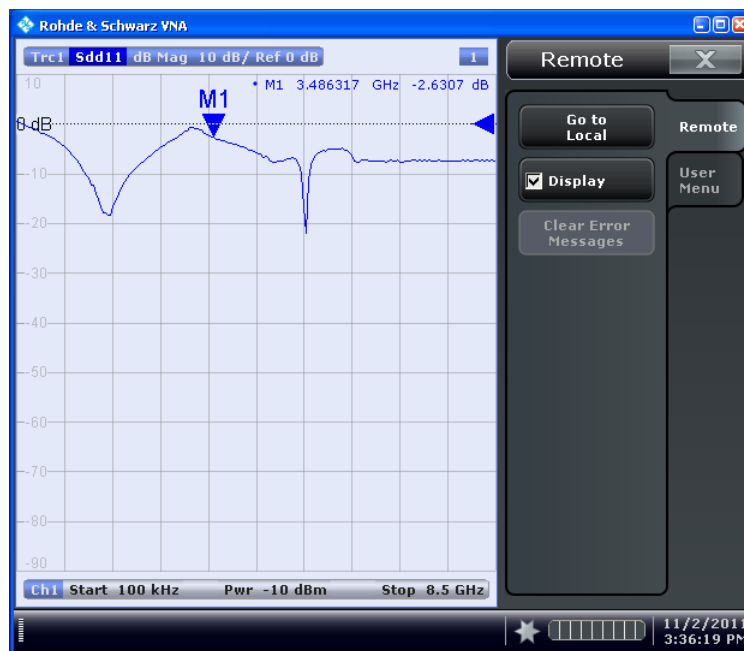

Switching on the display is ideal for program test purposes but tends to slow down the measurement. Therefore, it is recommended to switch off the display in real measurement applications where a tested program script is to be executed repeatedly.



The analyzer provides a third display option where the measurement screen is only updated when this is triggered by the remote control command `SYSTEM:DISPlay:UPDate ONCE`.

The instrument remains in the remote state until it is reset to the manual state via the GUI or via remote control (see [Chapter 5.1.3.2, "Returning to Manual Operation"](#), on page 364). You can also lock the remote (touch)screen using `SYSTEM:TSLock SCReen`.

A tooltip across the bottom of the remote screen indicates a remote command error. You can switch off this tooltip using `SYSTEM:ERRor:DISPlay:REMote OFF`.

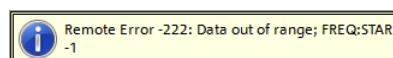

SCPI commands:

```
@REM
```

```
SYSTEM:DISPlay:UPDate
```

```
SYSTEM:TSLock
```

```
SYSTEM:ERRor:DISPlay[:REMote]
```

### 5.1.3.1 Setting the Device Address

The GPIB address (primary address) of the instrument is factory-set to 20. It can be changed manually in the "SYSTEM > SETUP > Remote Settings" tab or via remote control. For remote control, addresses 0 through 30 are permissible. The GPIB address is maintained after a reset of the instrument settings.

SCPI commands:

```
SYSTem:COMMunicate:GPIB[:SELF]:ADDRes
```

### 5.1.3.2 Returning to Manual Operation

Return to manual operation can be initiated via the front panel or via remote control.

- Manually: tap the Local softkey in the remote screen.
- Via GPIB bus: CALL IBLOC(device%)
- Via RSIB or VXI-11 protocol: @LOC and @REM can be used to switch from remote to manual control and back.



#### Local lockout

Before returning to manual control, command processing must be completed. If this is not the case, the analyzer switches back to remote control immediately.

Returning to manual control by tapping the "Go to Local" softkey can be disabled e.g. by the Local Lockout Message (via GPIB: LLO; see [Chapter 9.1.3.2, "Interface Messages"](#), on page 807). This prevents unintentional switch-over, i.e. return to manual control is possible via remote control only.

Returning to manual control via the front panel keys can be enabled again, e.g. by deactivating the REN control line of the GPIB bus.

## 5.1.4 Combining Manual and Remote Control

Using a remote control script is the quickest and easiest way of performing complicated tasks which need to be repeated many times. On the other hand, it is often preferable to control a previously configured measurement manually in order to observe the result on the screen.

The analyzer provides a number of tools for combining manual and remote control:

- **User Keys**

The remote control commands `SYSTem:USER:KEY...` place up to 8 softkeys with arbitrary functionality on the remote screen. The softkeys appear in the "User Menu" tab of the "Remote" softtol. When a softkey is selected, the ESR bit no. 6 (User Request) is set, and the response for `SYSTem:USER:KEY?` is changed. This behavior can serve as a control mechanism in remote control scripts.

SCPI commands:

```
SYSTem:USER:KEY
```

## 5.2 Messages

The messages transferred on the data lines of the GPIB bus or via the RSIB / VXI-11 protocol can be either interface messages or device messages. For a description of interface messages refer to the relevant sections:

- [Chapter 9.1.3, "GPIB Interface"](#), on page 805
- [Chapter 9.1.2, "LAN Interface"](#), on page 805

### 5.2.1 Device Messages (Commands and Device Responses)

Depending on the selected "Codec" (see [SYSTEM:COMMunicate:CODec](#) on page 711), device messages are either transferred in ANSI, UTF-8 or Shift JIS format. A distinction is made according to the direction in which device messages are transferred:

- Commands are messages the controller sends to the instrument. They operate the device functions and request information.
- Device responses are messages the instrument sends to the controller after a query. They can contain measurement results, instrument settings and information on the instrument status.

Commands are subdivided according to two criteria:

1. According to the effect they have on the instrument:
  - Setting commands cause instrument settings such as a reset of the instrument or setting the output level to some value.
  - Queries cause data to be provided for output on the GPIB bus, e.g. for identification of the device or polling the active input.
2. According to their definition in standard IEEE 488.2:
  - Common commands have a function and syntax that is exactly defined in standard IEEE 488.2. Typical tasks are the management of the standardized status registers, reset and selftest.
  - Instrument-control commands are functions that depend on the features of the instrument such as frequency settings. A majority of these commands has also been standardized by the SCPI consortium.

The device messages have a characteristic structure and syntax. In the SCPI reference chapter all commands are listed and explained in detail.

### 5.2.2 SCPI Command Structure and Syntax

SCPI commands consist of a so-called header and, in most cases, one or more parameters. The header and the parameters are separated by a white space (ASCII code 0 to 9, 11 to 32 decimal, e.g. blank). The headers may consist of several mnemonics. Queries are formed by directly appending a question mark to the header.

Common commands and device-specific commands differ in their syntax.

### SCPI compatibility

The analyzers are compatible to the final SCPI version 1999.0. Not all of the commands supported by the instrument are taken from the SCPI standard (Standard Commands for Programmable Instruments), however, their syntax follows SCPI rules. The SCPI standard is based on standard IEEE 488.2 and aims at the standardization of instrument-control commands, error handling and the status registers.

The requirements that the SCPI standard places on command syntax, error handling and configuration of the status registers are explained in detail in the following sections.



### Reset values

In contrast to instruments with manual control, which are designed for maximum possible operating convenience, the priority of remote control is the predictability of the device status. This means that when incompatible settings are attempted, the command is ignored and the device status remains unchanged, i.e. other settings are not automatically adapted. Therefore, GPIB bus control programs should always define an initial device status (e.g. with the command \*RST) and then implement the required settings.

#### 5.2.2.1 Common Commands

Common (=device-independent) commands consist of a header preceded by an asterisk "\*" and possibly one or more parameters.

Examples:	
*RST	RESET, resets the instrument.
*ESE 253	EVENT STATUS ENABLE, sets the bits of the event status enable registers.
*ESR?	EVENT STATUS QUERY, queries the contents of the event status register.

#### 5.2.2.2 Instrument-Control Commands

Instrument-control commands are based on a hierarchical structure and can be represented in a command tree. The command headers are built with one or several mnemonics (keywords). The first level (root level) mnemonic identifies a complete command system.

<p>Example:</p> <p><code>SENSe</code> This mnemonic identifies the command system <code>SENSe</code>.</p> <p>For commands of lower levels, the complete path has to be specified, starting on the left with the highest level, the individual mnemonics being separated by a colon ":".</p>
<p>Example:</p> <p><code>SENSe:FREQuency:STARt 1GHZ</code></p> <p>This command is located on the third level of the <code>SENSe</code> system. It defines the start frequency of the sweep.</p>

The following rules simplify and abbreviate the command syntax:

- **Multiple mnemonics**

Some mnemonics occur on several levels within one command system. Their effect depends on the structure of the command, i. e. on the position in the command header they are inserted in.

**Example:**

```
SOURce:FREQuency:CW 1GHZ
```

This command contains the mnemonic `SOURce` in the first command level. It defines the frequency for sweep types operating at fixed frequency.

```
TRIGger:SOURce EXTernal
```

This command contains the mnemonic `SOURce` in the second command level. It defines the trigger source "external trigger".

- **Optional mnemonics**

Some command systems permit certain mnemonics to be optionally inserted into the header or omitted. These mnemonics are marked by square brackets in this manual. The full command length must be recognized by the instrument for reasons of compatibility with the SCPI standard. Some commands are considerably shortened by omitting optional mnemonics.

**Example:**

```
TRIGger[:SEQuence]:SOURce EXTernal
```

This command defines the trigger source "external trigger". The following command has the same effect:

```
TRIGger:SOURce EXTernal
```

**Note:**

The short form is marked by upper case letters, the long form corresponds to the complete word. Upper case and lower case notation only serves to distinguish the two forms in the manual, the instrument itself is case-insensitive.

- **Parameters**

Parameters must be separated from the header by a white space. If several parameters are specified in a command, they are separated by a comma ",". For a description of the parameter types, refer to section Parameters.

**Example:**

```
SOURce:GROup 1,1
```

This command defines a group of measured ports.

- **Numeric suffix**

If a device features several functions or features of the same kind, e.g. several channels or test ports, the desired function can be selected by a suffix added to the command. Entries without suffix are interpreted like entries with the suffix 1.

**Example:**

```
SOURce:GROup2 1,1
```

This command defines a second group (group no 2) of measured ports.

### 5.2.2.3 Structure of a Command Line

A command line may consist of one or several commands. It is terminated by a <New Line>, a <New Line> with EOI or an EOI together with the last data byte. Tools like the GPIB Explorer automatically produce an EOI together with the last data byte.

Several commands in a command line must be separated by a semicolon ";". If the next command belongs to a different command system, the semicolon is followed by a colon.

**Example:** `TRIGger:SOURce EXTernal;;SENSe:FREQuency:START 1GHZ`

This command line contains two commands. The first command belongs to the `TRIGger` system and defines the trigger source (external trigger). The second command belongs to the `SENSe` system and defines the start frequency of the sweep.

If the successive commands belong to the same system, having one or several levels in common, the command line can be abbreviated. To this end, the second command after the semicolon starts with the level that lies below the common levels. The colon following the semicolon must be omitted in this case.

**Example:** `TRIG:SOUR EXT;:TRIG:TIM 0.1`

This command line is represented in its full length and contains two commands separated from each other by the semicolon. Both commands are part of the `TRIGger` command system, i.e. they have one level in common.

When abbreviating the command line, the second command begins with the level below `TRIG`. The colon after the semicolon is omitted. The abbreviated form of the command line reads as follows:

`TRIG:SOUR EXT; TIM 0.1`

However, a new command line always begins with the complete path.

<b>Example:</b>	<code>TRIG:SOUR EXT</code> <code>TRIG:THR LOW</code>
-----------------	---

#### 5.2.2.4 Responses to Queries

A query is defined for each setting command unless explicitly specified otherwise. It is formed by adding a question mark to the associated setting command. According to SCPI, the responses to queries are partly subject to stricter rules than in standard IEEE 488.2.

1. The requested parameter is transmitted without header.  
**Example:** `TRIGger:SOURce?` **Response:** `IMM`
2. Maximum values, minimum values and all further quantities which are requested via a special text parameter are returned as numerical values.  
**Example:** `SENSe:FREQuency:STOP? MAX` **Response:** `8000000000`
3. Numerical values are output without their unit. The default unit for each command is reported in the SCPI command description.  
**Example:** `SENSe:FREQuency:STOP? MAX` **Response:** `8000000000` for 8 GHz
4. Boolean values are returned as 0 (for OFF) and 1 (for ON).  
**Example:** `SWEep:TIME:AUTO?` **Response:** `1`
5. Text (character data) is returned in short form (see also next section).



**Example:** TRIGger: SOURce? Response: IMM

## 5.2.3 SCPI Parameters

Many commands are supplemented by a parameter or a list of parameters. The parameters must be separated from the header by a "white space". Permissible parameters are numerical values, Boolean parameters, text, character strings and block data. The type of parameter required for the respective command and the permissible range of values are specified in the command description.

### 5.2.3.1 Numeric Values

Numeric values can be entered in any form, i.e. with sign, decimal point and exponent. Values exceeding the resolution of the instrument are rounded up or down. The mantissa may comprise up to 255 characters, the values must be in the value range – 9.9E37 to 9.9E37. The exponent is introduced by an E or e. Entry of the exponent alone is not allowed. In the case of physical quantities, the unit can be entered. Permissible unit prefixes are G (giga), MA (mega), MOHM and MHZ are also permissible), K (kilo), M (milli), U (micro) and N (nano). If the unit is missing, the default unit is used.

**Example:**

SOUR:RFG:FREQ 1.5GHz is equivalent to

SOUR:RFG:FREQ 1.5E9

#### Special numeric values

The texts MINimum, MAXimum, DEFault, UP and DOWN are interpreted as special numeric values. A query returns the associated numerical value.

**Example:**

Setting command: SENSE:FREQuency:START MINimum

The query SENSE:FREQuency:START? returns 300000 (the exact value depends on the analyzer model).

The following special values can be used:

- MIN/MAX MINimum and MAXimum denote the minimum and maximum value of a range of numeric values.
- DEF DEFault denotes the preset value. This value is set by the \*RST command.
- **UP/DOWN** UP, DOWN increases or reduces the numeric value by one step. The step width is reported in the detailed command description.
- INF/NINF Negative INFIinity (NINF) represent the numerical values –9.9E37 or +9.9E37, respectively. INF and NINF are only sent as device responses.
- NAN Not a Number (NAN) represents the value 9.91E37. NAN is only sent as device response. This value is not defined. Possible causes are division by zero, subtraction or addition of infinite and the representation of missing values.



Unless it is explicitly stated in the command description you can use the special numeric parameters for all commands of the analyzer.

### 5.2.3.2 Boolean Parameters

Boolean parameters represent two states. The **ON** state (logically true) is represented by ON or a numerical value different from 0. The **OFF** state (logically false) is represented by **OFF** or the numerical value 0. A query responds with 0 or 1.

**Example:** Setting command: `SWEep:TIME:AUTO ON`

Query: `SWEep:TIME:AUTO?` returns 1

### 5.2.3.3 Text Parameters

Text parameters observe the syntax rules for mnemonics, i.e. they can be entered using a short or long form. Like any parameter, they have to be separated from the header by a white space. In the case of a query, the short form of the text is provided.

**Example:** Setting command: `TRIGger:SOURce EXTernal`

Query: `TRIGger:SOURce?` returns EXT

### 5.2.3.4 Strings

Strings must always be entered within single or double quotation marks (' or ").

**Example:** `CONFigure:CHANnel:NAME "Channel 4"` or

`CONFigure:CHANnel:NAME 'Channel 4'`

### 5.2.3.5 Block Data Format

Block data is a transmission format which is suitable for the transmission of large amounts of data. A command using a block data parameter with definite length has the following structure:

**Example:** `HEADer:HEADer #45168xxxxxxxx`

The hash symbol # introduces the data block. The next number indicates how many of the following digits describe the length of the data block. In the example the 4 following digits indicate the length to be 5168 bytes. The data bytes follow. During the transmission of these data bytes all End or other control signs are ignored until all bytes are transmitted.

A #0 combination introduces a data block of indefinite length. The use of the indefinite format requires a NL^END message to terminate the data block. This format is useful when the length of the transmission is not known or if speed or other considerations prevent segmentation of the data into blocks of definite length.

### 5.2.3.6 Overview of Syntax Elements

:	The colon separates the mnemonics of a command. In a command line the separating semicolon marks the uppermost command level.
;	The semicolon separates two commands of a command line. It does not alter the path.
,	The comma separates several parameters of a command.
?	The question mark forms a query.
*	The asterisk marks a common command.
' , "	Quotation marks introduce a string and terminate it.
#	The hash sign # introduces binary, octal, hexadecimal and block data. Binary: #B10110 Octal: #O7612 Hexadecimal: #HF3A7 Block: #21312
	A "white space" (ASCII-Code 0 to 9, 11 to 32 decimal, e.g. blank) separates header and parameter.

## 5.3 Basic Remote Control Concepts

The functionality of the network analyzer's remote control commands has been defined in close analogy to the menu commands and control elements of the graphical user interface (GUI). The basic concepts of recall sets, traces, channels, and diagram areas remain valid in remote control. Moreover, all commands follow SCPI syntax rules, and SCPI-confirmed commands have been used whenever possible. These principles largely simplify the development of remote control scripts.

The GUI and the remote control command set both aim at maximum operating convenience. In manual control this generally means that the control elements are easy to find and intuitive to handle, and that the effect of each operation is easy to verify on the screen. Convenient remote control operation depends on a simple and systematic program syntax and on a predictable instrument state; the display of results is secondary.

These differences suggest the peculiarities in the analyzer's remote control concept discussed in the following sections.

### 5.3.1 Traces, Channels, and Diagram Areas

Like in manual control, traces can be assigned to a channel and displayed in diagram areas (see section Traces, Channels and Diagram Areas in Chapter 3). There are two main differences between manual and remote control:

- A trace can be created without being displayed on the screen.
- A channel must not necessarily contain a trace. Channel and trace configurations are independent of each other.

The following frequently used commands create and delete traces, channels, and diagram areas:

Create new trace and new channel (if channel <Ch> does not exist yet)	CALCulate<Ch>:PARAmeter:SDEFine '<Trace Name>', '< Meas Parameter>'
Delete trace	CALCulate<Ch>:PARAmeter:DELEte '<Trace Name>'
Create or delete channel	CONFigure:CHANnel<Ch>[:STATe] ON   OFF
Create or delete diagram area	DISPlay:WINDow<Wnd>:STATe ON   OFF
Display trace in diagram area	DISPlay:WINDow<Wnd>:TRACe<WndTr>:FEED

The assignment between traces, channels, and diagram areas is defined via numeric suffixes as illustrated in the following example:

**Example:**

```
CALC4:PAR:SDEF 'Ch4Tr1', 'S11'
```

Create channel 4 (channel suffix 4) and a trace named "Ch4Tr1" to measure the input reflection coefficient S11. The trace is created but not displayed.

```
DISP:WIND2:STAT ON
```

Create diagram area no. 2 (window suffix 2).

```
DISP:WIND2:TRAC9:FEED 'CH4TR1'
```

Display the generated trace (identified by its name "Ch4Tr1") in diagram area no. 2 (window suffix 2), assigning the trace number 9 (trace suffix 9) to it.

### 5.3.2 Active Traces in Remote Control

In manual control there is always exactly one active trace, irrespective of the number of channels and traces defined. The "active channel" contains the active trace; see [Chapter 3.1.3.1, "Trace Settings"](#), on page 13.

In remote control, each channel contains an active trace (unless the channel contains no trace at all), so the notion of "active channel" is meaningless. This principle actually simplifies the remote control command syntax, because it allows the active trace in a particular channel to be referenced by means of the channel suffix. No additional trace identifier is needed; there is no need either to distinguish channel and trace settings using mnemonics or suffixes.

The active traces are handled as follows:

- After a preset (\*RST), the analyzer displays a single diagram area with the default trace no. 1 named TRC1. The trace is active in manual and in remote control.
- In manual control, a new, added trace automatically becomes the active trace. To select another trace as the active trace, tap inside the trace list.
- In remote control, a new trace added via CALCulate<Ch>:PARAmeter:SDEFine '<trace\_name>', '<parameter>' also becomes the active trace. To select

another trace as the active trace, use (CALCulate<Ch>:PARAmeter:SElect '<trace\_name>').

- The active traces for manual and remote control may be different.

The following program example illustrates how to create, select and reference traces. It is instructive to observe the analyzer screen in order to check the effect of each step.

**Example:**

```
*RST
```

Reset the analyzer, creating channel no. 1 with the default trace "Trc1". The trace is displayed in diagram area no. 1.

```
CALC1:PAR:SDEF 'Trc2', 'S11'; DISP:WIND:TRAC2:FEED 'Trc2'
```

Create a new trace named "Trc2", assigned to channel no. 1 (the suffix 1 after CALC, may be omitted), and display the trace. The new trace automatically becomes the active trace for manual and for remote control. To check this, tap "Trace – Marker – Marker 1" to create a marker. The marker is assigned to "Trc2". Delete all markers ("Trace – Marker – All Markers Off").

```
CALC1:MARK ON
```

**Example:**

To verify that "Trc2" is also active for remote control, use the channel suffix 1 after CALC (may be omitted) to reference the active trace in channel 1 and create a marker "Mkr 1". The marker is assigned to "Trc2".

**Example:**

```
CALC:PAR:SEL 'Trc1'; CALC1:MARK ON
```

Select the old default trace "Trc1" as the active trace for remote control. Create a new marker to verify that "Trc1" is now the active trace in channel 1.



In the SCPI command description, the numeric suffix <Ch> is used for channel settings (it denotes the configured channel), whereas <Chn> is used for trace settings (it denotes the active trace in the channel).

### 5.3.3 Initiating Measurements, Speed Considerations

After a reset the network analyzer measures in continuous mode. The displayed trace shows the result of the last sweep and is continuously updated. This provides a permanent visual control over the measurement and the effect of any analyzer settings.

In remote control, it is advisable to follow a different approach in order use the analyzer's resources to full capacity and gain measurement speed. The following principles can help to optimize a remote control program (see also programming example in [Chapter 7.1.1, "Typical Stages of a Remote Control Program"](#), on page 767):

- Switch off the measurement while configuring your instrument.
- Use a minimum number of suitably positioned sweep points.

- Start a single sweep, observing proper command synchronization, and retrieve your results.

The following command sequence performs a single sweep in a single channel.

**Example:**

```
*RST; :INITiate:CONTinuous:ALL OFF
```

Activate single sweep mode for all channels (including the channels created later).

```
INITiate1:IMMediate; *WAI
```

Start a single sweep in channel no. 1, wait until the sweep is terminated before proceeding to the next command (see [Chapter 5.4, "Command Processing"](#), on page 375).



### Sweeps in several channels

It is also possible to subdivide the channels within a recall set into active and inactive channels. The analyzer will then measure in the subset of active channels only; see program example for `CONFigure:CHANnel<Ch>:MEASure[:STATe]`.

## 5.3.4 Addressing Traces and Channels

The analyzer provides a variety of schemes for addressing traces and channels and for querying trace and channel names. The following tables give an overview.

**Table 5-1: Addressing channels**

Method	Commands / Example
Channel number <Ch> as a numeric suffix	CONFigure:CHANnel<Ch>[:STATe] ON
Query all channel names	CONFigure:CHANnel:CATalog? (returns the names of all channels)
Assign or query channel name of a channel numbered <Ch>	CONFigure:CHANnel<Ch>:NAME 'ABCD' CONFigure:CHANnel<Ch>:NAME? (returns 'ABCD')
Query channel number assigned to a channel named 'ABCD'	CONFigure:CHANnel<Ch>:NAME:ID? 'ABCD' (returns the actual channel number, the channel suffix is ignored)

**Table 5-2: Addressing traces**

Method	Commands / Example
Channel number <Chn> used as a reference for the active trace in the channel	CALCulate<Chn>:MARKer<Mk>[:STATe] ON
Trace name (string variable) used as a reference for the trace	CALCulate<Ch>:PARAmeter:DELeTe '<Trace Name>'
Trace number <Trc> as a numeric suffix (exception!)	CONFigure:TRACe<Trc>:NAME?
Trace number <WndTr> within a particular diagram area <Wnd>	DISPlay:WINDow<Wnd>:TRACe<WndTr>:FEED

Method	Commands / Example
Query all trace names	CONFigure:TRACe:CATaLog? (returns the names of all traces)
Assign or query trace name of a trace numbered <Trc>	CONFigure:TRACe<Trc>:NAME 'ABCD' CONFigure:TRACe<Trc>:NAME? (returns 'ABCD')
Query trace number assigned to a trace named 'ABCD'	CONFigure:TRACe<Trc>:NAME:ID? 'ABCD' (returns the actual trace number; the trace suffix is ignored)

Table 5-3: Mixed commands

Method	Commands / Example
Query channel name for a trace referenced by its trace name	CONFigure:TRACe<Trc>:CHANnel:NAME? 'ABCD' (returns the channel name for trace 'ABCD'; the trace suffix is ignored)
Query channel number for a trace referenced by its trace name	CONFigure:TRACe<Trc>:CHANnel:NAME:ID? 'ABCD' (returns the actual channel number for trace 'ABCD'; the trace suffix is ignored)

## 5.4 Command Processing

The block diagram below shows how commands are serviced in the instrument.

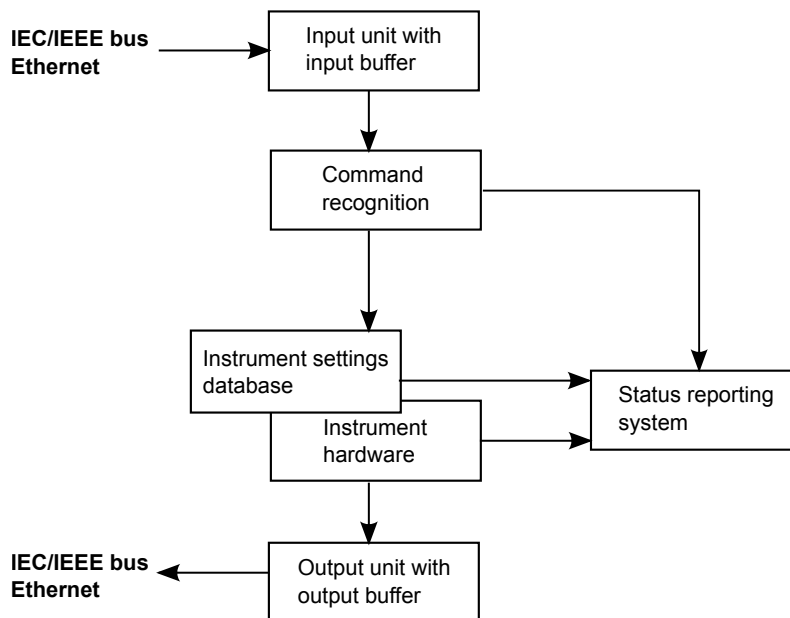

The individual components work independently and simultaneously. They communicate with each other by means of so-called messages.

### 5.4.1 Input Unit

The input unit receives commands character by character from the controller and collects them in the input buffer. The input unit sends a message to the command recognition as soon as the input buffer is full or as soon as it receives a delimiter, <PROGRAM MESSAGE TERMINATOR>, as defined in IEEE 488.2, or the interface message DCL.

If the input buffer is full, the message data traffic is stopped and the data received up to then is processed. Subsequently the traffic is continued. If, however, the buffer is not yet full when receiving the delimiter, the input unit can already receive the next command during command recognition and execution. The receipt of a DCL clears the input buffer and immediately initiates a message to the command recognition.

### 5.4.2 Command Recognition

The command recognition stage analyzes the data received from the input unit. It proceeds in the order in which it receives the data. Only a DCL is serviced with priority, e.g. a GET (Group Execute Trigger) is only executed after the commands received before. Each recognized command is immediately transferred to the data set but not executed immediately.

The command recognition detects syntax errors in the commands and transfers them to the status reporting system. The rest of a command line after a syntax error is still executed, if possible. After the syntax check, the range of the numerical parameters is checked, if required.

If the command recognition detects a delimiter or a DCL, it also requests the data set to perform the necessary instrument hardware settings. Subsequently it is immediately prepared to process further commands. This means that new commands can already be serviced while the hardware is still being set (overlapping execution).

### 5.4.3 Data Base and Instrument Hardware

The expression instrument hardware denotes the part of the instrument fulfilling the actual instrument function – signal generation, measurement etc. The controller is not included. The data base manages all the parameters and associated settings required for the instrument hardware.

Setting commands lead to an alteration in the data set. The data set management enters the new values (e.g. frequency) into the data set, however, it only passes them on to the hardware when requested by the command recognition. This can only occur at the end of a command line, therefore the order of the setting commands in the command line is not relevant.

The commands are only checked for their compatibility among each other and with the instrument hardware immediately before they are transmitted to the instrument hardware. If the instrument detects that execution is not possible, an execution error is signalled to the status reporting system. All alterations of the data set are cancelled, the instrument hardware is not reset. Due to the delayed checking and hardware setting, however, impermissible instrument states can be set for a short period of time within



one command line without this leading to an error message (example: simultaneous activation of a frequency and a power sweep). At the end of the command line, however, a permissible instrument state must have been reached again.

Before passing on the data to the hardware, the settling bit in the `STATUS:OPERation` register is set (see [Chapter 5.5.3.4, "STATUS:OPERation"](#), on page 385). The hardware executes the settings and resets the bit again as soon as the new state has settled. This fact can be used to synchronize command servicing.

Queries induce the data set management to send the desired data to the output unit.

#### 5.4.4 Status Reporting System

The status reporting system collects information on the instrument state and makes it available to the output unit on request. The exact structure and function are described in [Chapter 5.5, "Status Reporting System"](#), on page 379.

#### 5.4.5 Output Unit

The output unit collects the information requested by the controller, which it receives from the data set management. It processes it according to the SCPI rules and makes it available in the output buffer. If the information requested is longer, it is made available in portions without this being recognized by the controller.

If the instrument is addressed as a talker without the output buffer containing data or awaiting data from the data set management, the output unit sends the error message `Query UNTERMINATED` to the status reporting system. No data is sent on the GPIB bus or via the Ethernet, the controller waits until it has reached its time limit. This behavior is specified by SCPI.

#### 5.4.6 Command Sequence and Command Synchronization

IEEE 488.2 defines a distinction between overlapped and sequential commands:

- A sequential command is one which finishes executing before the next command starts executing. Commands that are processed quickly are usually implemented as sequential commands.
- An overlapping command is one which does not automatically finish executing before the next command starts executing. Usually, overlapping commands take longer to process and allow the program to do other tasks while being executed. If overlapping commands do have to be executed in a defined order, e.g. in order to avoid wrong measurement results, they must be serviced sequentially. This is called synchronization between the controller and the analyzer.

According to [Chapter 5.4.3, "Data Base and Instrument Hardware"](#), on page 376, setting commands within one command line, even though they may be implemented as sequential commands, are not necessarily serviced in the order in which they have been received. In order to make sure that commands are actually carried out in a certain order, each command must be sent in a separate command line. Examples:

**Example 1: Commands and queries in one message**

The response to a query combined in a program message with commands that affect the queried value is not predictable. Sending

```
:FREQ:STAR 1GHZ;SPAN 100
:FREQ:STAR?
```

always returns 1000000000 (1 GHz). When:

```
:FREQ:STAR 1GHz;STAR?;SPAN 1000000
```

is sent, however, the result is not specified by SCPI. The result could be the value of `START` before the command was sent since the instrument might defer executing the individual commands until a program message terminator is received. The result could also be 1 GHz if the instrument executes commands as they are received.

As a general rule, send commands and queries in different program messages.

**Example 2: Overlapping command with \*OPC**

The analyzer implements `INITiate[:IMMEDIATE]...` commands as overlapped commands. Assuming e.g. that `INITiate[:IMMEDIATE][:DUMMY]` takes longer to execute than `*OPC`, sending the command sequence

```
INIT; *OPC.
```

results in initiating a sweep and, after some time, setting the OPC bit in the ESR. Sending the commands:

```
INIT; *OPC; *CLS
```

still initiates a sweep. Since the operation is still pending when the analyzer executes `*CLS`, forcing it into the Operation Complete Command Idle State (OCIS), `*OPC` is effectively skipped. The OPC bit is not set until the analyzer executes another `*OPC` command.



The analyzer provides only two overlapped commands, `INITiate<Ch>[:IMMEDIATE][:DUMMY]` and `INITiate<Ch>[:IMMEDIATE]:ALL`. What is said below is not relevant for the other (sequential) SCPI commands.

---

**Preventing overlapping execution**

To prevent an overlapping execution of commands, one of the commands `*OPC`, `*OPC?` or `*WAI` can be used. For a programming example refer to [Chapter 7.1.1.3, "Start of the Measurement and Command Synchronization"](#), on page 768.

---

Command	Action after the hardware has settled	Programming the controller
*WAI	Stops further command processing until all commands sent before *WAI have been executed Note: The GPIB bus handshake is not stopped	Send *WAI directly after the command which should be terminated before the next command is executed.
*OPC?	Stops command processing until 1 is returned, i.e. until the "Operation Complete" bit has been set in the ESR. This bit indicates that the previous commands have been completed.	Send *OPC? directly after the command which should be terminated before the next command is executed.
*OPC	Sets the operation complete bit in the ESR after all previous commands have been executed.	<ul style="list-style-type: none"> <li>– Set bit 0 in the ESE</li> <li>– Set bit 5 in the SRE</li> <li>– Wait for service request (SRQ)</li> </ul>

## 5.5 Status Reporting System

The status reporting system stores all information on the present operating state of the instrument, and on errors which have occurred. This information is stored in the status registers and in the error queue. Both can be queried using the `STATus...` commands.

### Hierarchy of status registers

As shown in section [Overview of Status Registers](#), the status information is of hierarchical structure.

- **STB, SRE:**  
The STatus Byte (STB) register and its associated mask register Service Request Enable (SRE) form the highest level of the status reporting system. The STB provides a rough overview of the instrument status, collecting the information of the lower-level registers.
- The STB receives its information from:  
The Event Status Register (ESR) with the associated mask register standard Event Status Enable (ESE).  
The `STATus:OPERation` and `STATus:QUESTionable` registers which are defined by SCPI and contain detailed information on the instrument.
- **IST, PPE:**  
The IST flag ("Individual STatus"), like the SRQ, combines the entire instrument status in a single bit. The PPE is associated to the IST flag. It fulfills an analogous function for the IST flag as the SRE does for the service request.
- **Output buffer:**  
contains the messages the instrument returns to the controller. It is not part of the status reporting system but determines the value of the MAV bit in the STB.

All status registers have the same internal structure, see [Structure of an SCPI Status Register](#).

For more information on the individual status registers see [Contents of the Status Registers](#).



### SRE register

The service request enable register SRE can be used as ENABLE part of the STB if the STB is structured according to SCPI. By analogy, the ESE can be used as the ENABLE part of the ESR.

## 5.5.1 Overview of Status Registers

The status registers of the R&S ZNC/ZND are implemented as shown below.

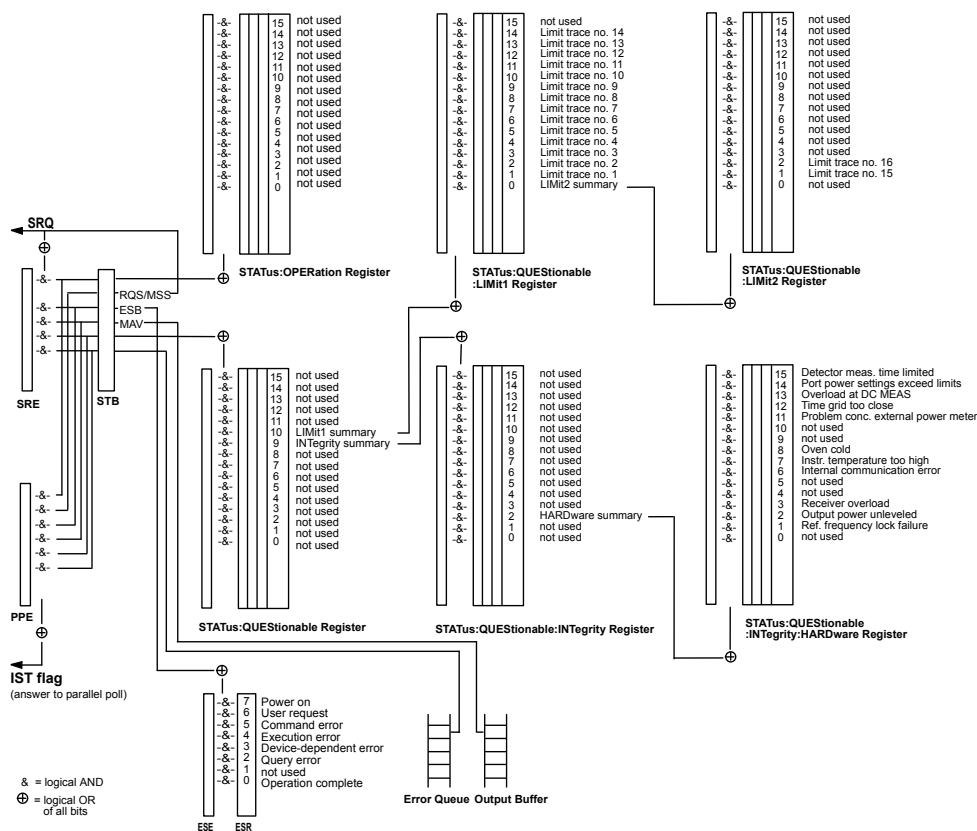

## 5.5.2 Structure of an SCPI Status Register

Each standard SCPI register consists of 5 parts which each have a width of 16 bits and have different functions. The individual bits are independent of each other, i.e. each hardware status is assigned a bit number which is valid for all five parts. Bit 15 (the most significant bit) is set to zero for all parts. Thus the contents of the register parts can be processed by the controller as positive integer.

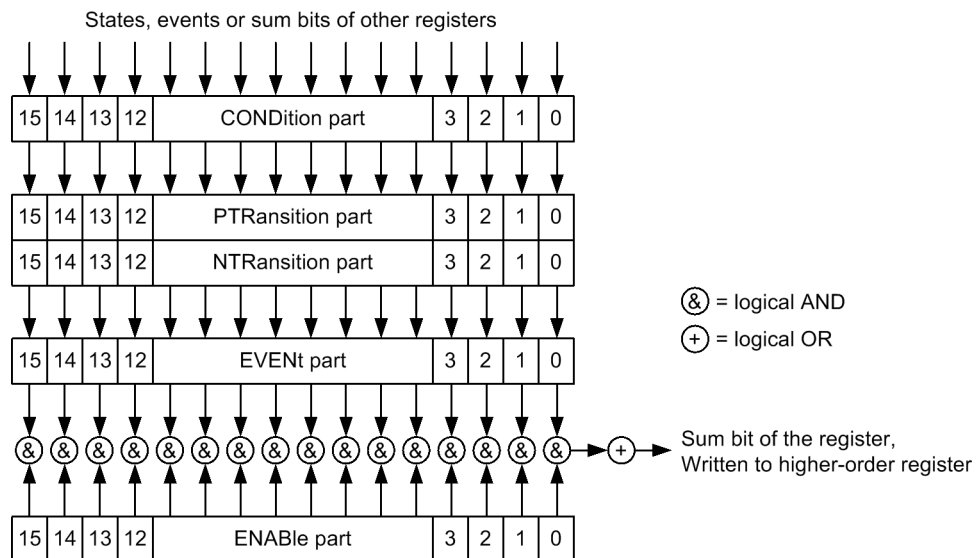

The sum bit is obtained from the EVENT and ENABLe part for each register. The result is then entered into a bit of the CONDition part of the higher-order register.

The instrument automatically generates the sum bit for each register. Thus an event can lead to a [Service Request](#) throughout all levels of the hierarchy.

The five parts of an SCPI register have different properties and function as described below.

**CONDition**

The CONDition part is permanently overwritten by the hardware or the sum bit of the next lower register. Its contents always reflect the current instrument state.

This register part can only be read, but not overwritten or cleared. Reading the CONDition register is nondestructive.

**PTRansition**

The two transition register parts define which state transition of the condition part (none, 0 to 1, 1 to 0 or both) is stored in the EVENT part.

The Positive TRansition part acts as a transition filter. When a bit of the CONDition part is changed from 0 to 1, the associated PTR bit decides whether the EVENT bit is set to 1:

- PTR bit = 1: the EVENT bit is set
- PTR bit = 0: the EVENT bit is not set

This status register part can be overwritten and read at will. Reading the PTRansition register is nondestructive.

### NTRansition

The Negative TRansition part also acts as a transition filter. When a bit of the CONDition part is changed from 1 to 0, the associated NTR bit decides whether the EVENT bit is set to 1.

- NTR bit = 1: the EVENT bit is set.
- NTR bit = 0: the EVENT bit is not set.

This part can be overwritten and read at will. Reading the PTRansition register is non-destructive.

### EVENT

The EVENT part indicates whether an event has occurred since the last reading, it is the "memory" of the condition part. It only indicates events passed on by the transition filters. It is permanently updated by the instrument. This part can only be read by the user. Reading the register clears it. This part is often equated with the entire register.

### ENABLE

The ENABLE part determines whether the associated EVENT bit contributes to the sum bit (cf. below). Each bit of the EVENT part is ANDed with the associated ENABLE bit (symbol '&'). The results of all logical operations of this part are passed on to the sum bit via an OR function (symbol '+').

- ENAB bit = 0: The associated EVENT bit does not contribute to the sum bit.
- ENAB bit = 1: If the associated EVENT bit is "1", the sum bit is set to "1" as well.

This part can be overwritten and read by the user at will. Its contents are not affected by reading.

The **sum bit** is obtained from the EVENT and ENABLE part for each register. The result is then entered into a bit of the CONDition part of the higher-order register. The instrument automatically generates the sum bit for each register. Thus an event can lead to a service request throughout all levels of the hierarchy.

## 5.5.3 Contents of the Status Registers

The individual status registers are used to report different classes of instrument states or errors. The following status registers belong to the general model described in IEEE 488.2:

- The SStatus Byte (STB) gives a rough overview of the instrument status.
- The IST flag combines the entire status information into a single bit that can be queried in a [Parallel Poll](#).
- The Event Status Register (ESR) indicates general instrument states.

The status registers below belong to the device-dependent SCPI register model:

- The STATus:OPERation register contains conditions which are part of the instrument's normal operation.
- The STATus:QUEStionable register indicates whether the data currently being acquired is of questionable quality.

- The `STATUS:QUESTIONABLE:LIMIT<1|2>` register indicates the result of the limit check.
- The `STATUS:QUESTIONABLE:INTEGRITY` register monitors hardware failures of the analyzer.

### 5.5.3.1 STB and SRE

The Status Byte (STB) provides a rough overview of the instrument status by collecting the pieces of information of the lower registers. The STB represents the highest level within the SCPI hierarchy. A special feature is that bit 6 acts as the summary bit of the remaining bits of the status byte.

The Status Byte (STB) is linked to the Service Request Enable (SRE) register on a bit-by-bit basis.

- The STB corresponds to the `EVENT` part of an SCPI register, indicating the current instrument state. This register is cleared when it is read.
- The SRE corresponds to the `ENABLE` part of an SCPI register. If a bit is set in the SRE and the associated bit in the STB changes from 0 to 1, a [Service Request](#) (SRQ) is generated. Bit 6 of the SRE is ignored, because it corresponds to the summary bit of the STB.

The bits in the STB are defined as follows:

Bit No.	Meaning
2	<p><b>Error Queue not empty</b></p> <p>If this bit is enabled by the SRE, each entry of the error queue generates a <a href="#">Service Request</a> (SRQ). Thus an error can be recognized and further pinned down by polling the error queue. The poll provides an informative error message.</p>
3	<p><b>QUESTIONABLE status summary bit</b></p> <p>This bit is set if an <code>EVENT</code> bit is set in the <code>STATUS:QUESTIONABLE</code> register and the associated <code>ENABLE</code> bit is set to 1.</p> <p>The bit indicates a questionable instrument status, which can be further pinned down by polling the <code>QUESTIONABLE</code> register.</p>
4	<p><b>MAV bit</b> (message available)</p> <p>This bit is set if a message is available and can be read from the output buffer.</p> <p>This bit can be used to automatically transfer data from the instrument to the controller.</p>
5	<p><b>ESB bit</b></p> <p>Sum bit of the event status register. It is set if one of the bits in the event status register is set and enabled in the event status enable register.</p> <p>Setting of this bit implies an error or an event which can be further pinned down by polling the event status register.</p>

Bit No.	Meaning
6	<p><b>MSS bit</b> (master status summary bit)</p> <p>This bit is set if the instrument triggers a service request. This is the case if one of the other bits of this registers is set together with its mask bit in the service request enable register SRE.</p>
7	<p><b>OPERation status register summary bit</b></p> <p>This bit is set if an EVENT bit is set in the OPERation-Status register and the associated ENABLE bit is set to 1.</p> <p>The bit indicates that the instrument is currently performing an action. The type of action can be determined by polling the <a href="#">STATus:OPERation</a> register.</p>

#### Related common commands

The STB is read out using the command `*STB?` or a [Serial Poll](#).

The SRE can be set using command `*SRE` and read using `*SRE?`.

#### 5.5.3.2 IST Flag and PPE

In analogy to the [Service Request](#) (SRQ), the IST flag combines the entire status information in a single bit. It can be queried by means of a [Parallel Poll](#).

The Parallel Poll Enable (PPE) register determines which bits of the STB contribute to the IST flag. The bits of the STB are ANDed with the corresponding bits of the PPE, with bit 6 being used as well in contrast to the SRE. The IST flag results from the ORing of all results.

#### Related common commands

The IST flag is queried using the common command `*IST?`. The PPE can be set using `*PRE` and read using `*PRE?`.

See also [Common Commands](#).

#### 5.5.3.3 ESR and ESE

The Event Status Register (ESR) indicates general instrument states. It is linked to the Event Status Enable (ESE) register on a bit-by-bit basis.

- The ESR corresponds to the CONDition part of an SCPI register indicating the current instrument state (although reading is destructive).
- The ESE corresponds to the ENABLE part of an SCPI register. If a bit is set in the ESE and the associated bit in the ESR changes from 0 to 1, the ESB bit in the SStatus Byte is set.

The bits in the ESR are defined as follows:



Bit No.	Meaning
0	<b>Operation Complete</b> This bit is set on receipt of the command *OPC after all previous commands have been executed.
2	<b>Query Error</b> This bit is set if either the controller wants to read data from the instrument without having sent a query, or if it does not fetch requested data and sends new instructions to the instrument instead. The cause is often a query which is faulty and hence cannot be executed.
3	<b>Device-Dependent Error</b> This bit is set if a device-dependent error occurs. An error message with a number between -300 and -399 or a positive error number, which describes the error in greater detail, is entered into the error queue. See also <a href="#">Chapter 8, "Error Messages and Troubleshooting"</a> , on page 798.
4	<b>Execution Error</b> This bit is set if a received command is syntactically correct, but cannot be performed for other reasons. An error message with a number between -200 and -300, which describes the error in greater detail, is entered into the error queue.
5	<b>Command Error</b> This bit is set if a command which is undefined or syntactically incorrect is received. An error message with a number between -100 and -200, which describes the error in greater detail, is entered into the error queue.
6	<b>User Request</b> This bit is set when the instrument is switched over to manual control or when a user-defined softkey is used (see <a href="#">SYSTem:USER:KEY</a> ).
7	<b>Power On</b> (supply voltage on) This bit is set when the instrument is switched on.

### Related common commands

The Event Status Register (ESR) can be queried using `ESR?`. The Event Status Enable (ESE) register can be set using the command `*ESE` and read using `*ESE?`.

See also [Common Commands](#).

#### 5.5.3.4 STATus:OPERation

The STATus:OPERation register contains conditions which are part of the instrument's normal operation. The analyzer does not use the STATus:OPERation register.

#### 5.5.3.5 STATus:QUEStionable

The STATus:QUEStionable register indicates whether the acquired data is of questionable quality and monitors hardware failures of the analyzer. It can be queried using the commands `STATus:QUEStionable:CONDition?` or `STATus:QUEStionable:EVENT?`.

Bit No.	Meaning
9	<b>INTEgrity register summary</b> This bit is set if a bit is set in the STATUS:QUEStionable:INTEgrity register and the associated ENABLE bit is set to 1.
10	<b>LIMit register summary</b> This bit is set if a bit is set in the STATUS:QUEStionable:LIMit1 register and the associated ENABLE bit is set to 1.

### STATUS:QUEStionable:LIMit<1|2>

The STATUS:QUEStionable:LIMit<1|2> registers indicate the result of the limit check. They can be queried using the commands

STATUS:QUEStionable:LIMit<1|2>:CONDition? or  
STATUS:QUEStionable:LIMit<1|2>[:EVENT]?

STATUS:QUEStionable:LIMit1 is also the summary register of the lower-level STATUS:QUEStionable:LIMit2 register.

The bits in the STATUS:QUEStionable:LIMit1 register are defined as follows:

Bit No.	Meaning
0	<b>LIMit2 register summary</b> This bit is set if a bit is set in the STATUS:QUEStionable:LIMit2 register and the associated ENABLE bit is set to 1.
1	<b>Failed limit check for trace no. 1</b> This bit is set if any point on trace no. 1 fails the limit check.
...	...
14	<b>Failed limit check for trace no. 14</b> This bit is set if any point on trace no. 14 fails the limit check.

The bits in the STATUS:QUEStionable:LIMit2 register are defined as follows:

Bit No.	Meaning
0	Not used
1	<b>Failed Limit Check for Trace no. 15</b> This bit is set if any point on trace no. 15 fails the limit check.
2	<b>Failed Limit Check for Trace no. 16</b> This bit is set if any point on trace no. 16 fails the limit check.

### Numbering of traces

The traces numbers 1 to 16 are assigned as follows:

- Traces assigned to channels with smaller channel numbers have smaller trace numbers.
- Within a channel, the order of traces reflects their creation time: The oldest trace has the smallest, the newest trace has the largest trace number. This is equivalent

to the order of traces in the response string of the `CALCulate<Ch>:PARAMeter:CATalog? query`.

- The number of traces monitored cannot exceed 16. If a setup contains more traces, the newest traces are not monitored.

### STATus:QUEStionable:INTEgrity...

The `STATus:QUEStionable:INTEgrity` register monitors hardware failures of the analyzer. It can be queried using the commands

`STATus:QUEStionable:INTEgrity:CONDition?` or

`STATus:QUEStionable:INTEgrity[:EVENT]?`

`STATus:QUEStionable:INTEgrity` is also the summary register of the lower-level `STATus:QUEStionable:INTEgrity:HARDware` register.



Refer to the [Chapter 8, "Error Messages and Troubleshooting"](#), on page 798 for a detailed description of hardware errors including possible remedies.

The bits in the `STATus:QUEStionable:INTEgrity` register are defined as follows.

Bit No.	Meaning
2	<p><b>HARDware register summary</b></p> <p>This bit is set if a bit is set in the <code>STATus:QUEStionable:INTEgrity:HARDware</code> register and the associated <code>ENABLE</code> bit is set to 1.</p>

The `STATus:QUEStionable:INTEgrity:HARDware` register can be queried using the commands `STATus:QUEStionable:INTEgrity:HARDware:CONDition?` or `STATus:QUEStionable:INTEgrity:HARDware[:EVENT]?`

The bits in the `STATus:QUEStionable:INTEgrity:HARDware` register are defined as follows.

Bit No.	Meaning
0	Not used
1	<p><b>Reference frequency lock failure</b></p> <p>With external reference signal (System – External Reference active) or option ZVAB-B4 (oven quartz), the reference oscillator is phase locked to a 10 MHz signal. This bit is set if this phase locked loop (PLL) fails.</p> <p>For external reference: check frequency and level of the supplied reference signal.</p>
2	<p><b>Output power unlevelled</b></p> <p>This bit is set if the level control at one of the ports is unsettled or unstable, possibly due to an external disturbing signal.</p> <p>Change generator level at the port; check external components.</p>
3	<p><b>Receiver overload protection tripped</b></p> <p>This bit is set if the analyzer detects an excessive input level at one of the ports. If this condition persists, all internal sources are switched off.</p> <p>Reduce RF input level at the port. Check amplifiers in the external test setup, then switch on the internal source using <code>OUTPut ON</code>.</p>

Bit No.	Meaning
4	not used
5	Not used
6	<p><b>Internal communication error</b></p> <p>This bit is set if an internal error caused the analyzer to perform an automatic hardware reset. The current measurement results are possibly invalid.</p> <p>The bit is automatically cleared at the beginning of the next sweep, no action is required.</p>
7	<p><b>Instrument temperature is too high</b></p> <p>This bit is set if the analyzer detects that the instrument temperature is too high.</p> <p>Reduce ambient temperature, keep ventilation holes of the casing unobstructed.</p>
8	<p><b>Oven cold</b></p> <p>This bit is set if the oven for the optional oven quartz (OCXO, option ZVAB-B4) is not at its operating temperature.</p> <p>Wait until the oven has been heated up.</p>
9	<p><b>Unstable level control</b></p> <p>This bit is set if the analyzer detects an excessive source level at one of the ports. The signal is turned off and the sweep halted.</p> <p>Check signal path for the received wave, especially check external components. Then restart the sweep (<code>INITiate&lt;Ch&gt;[:IMMediate]</code>).</p>
10	not used
11	<p><b>Problem concerning external power meter</b></p> <p>This bit is set if an external power meter has been configured but cannot be controlled or provides error messages.</p> <p>Check whether the power meter is properly connected and switched on. Check the GPIB address; exclude address conflicts when using several external power meters or other equipment.</p>
12	<p><b>Time grid too close</b></p> <p>This bit is set if the sweep points for a time sweep are too close, so that the analyzer cannot process the measurement data until the next sweep point starts.</p> <p>Increase stop time, reduce no. of points, increase IF bandwidth. If possible reduce number of partial measurements, e.g. by restricting the number of ports measured.</p>
13	<p><b>Overload at DC MEAS</b></p> <p>This bit is set if the input voltage at one of the DC input connectors on the rear panel is too high.</p> <p>Reduce the input voltage.</p>
14	<p><b>Power settings exceed hardware limits</b></p> <p>This bit is set if the source power at one of the test ports is too high or too low.</p> <p>Reduce or increase the source power.</p>
15	<p><b>Detector meas time has been internally limited</b></p> <p>This bit is set if the selected measurement time for a detector (observation time) is too long.</p> <p>If desired, reduce the measurement time or select a smaller IF bandwidth.</p>

## 5.5.4 Application of the Status Reporting System

The purpose of the status reporting system is to monitor the status of one or several devices in a measuring system. To do this and react appropriately, the controller must receive and evaluate the information of all devices. The following standard methods described in the following sections are used:

- Service request (SRQ) initiated by the measuring device
- Serial poll of all devices in the bus system, initiated by the controller in order to find out who sent a SRQ and why
- Parallel poll of all devices
- Query of a specific instrument status by means of commands
- Query of the error queue

### 5.5.4.1 Service Request

The R&S ZNC/ZND can send a service request (SRQ) to the controller. Usually this service request causes an interrupt, to which the control program can react appropriately.

#### Initiating an SRQ

As shown in section [Overview of Status Registers](#), an SRQ is initiated if one or several of bits 2, 3, 4, 5 or 7 of the status byte are set and enabled in the SRE. Each of these bits summarizes the information of a further register, the error queue or the output buffer.

The ENABLE parts of the status registers can be set such that arbitrary bits in an arbitrary status register initiate an SRQ. To use the possibilities of the service request effectively, all bits in the enable registers SRE and ESE should be set to "1".

#### Example: Use \*OPC to generate an SRQ

1. Set bit 0 in the ESE (Operation Complete).
2. Set bit 5 in the SRE (ESB).
3. Insert \*OPC in the command sequence (e.g. at the end of a sweep)

As soon as all commands preceding \*OPC have been completed, the instrument generates an SRQ.

#### Example: Generate an SRQ when a limit is exceeded

1. Set bit 3 in the SRE (summary bit of the `STATUS:QUESTIONABLE` register, set after `STATUS:PRESet`)
2. Set bit 10 in the `STATUS:QUESTIONABLE:ENABLE` register (summary bit of the `STATUS:QUESTIONABLE:LIMIT1` register)
3. Set bit 1 in the `STATUS:QUESTIONABLE:LIMIT1:ENABLE` register

The R&S ZNC/ZND generates an SRQ when the event associated with bit 1 of the `STATUS:QUESTIONABLE:LIMIT1:ENABLE` register occurs, i.e. when any point on the first trace fails the limit check.

#### Example: Find out which event caused an SRQ

The procedure to find out which event caused an SRQ is analogous the procedure to generate an SRQ:

1. `STB?` (query the contents of the status byte in decimal form)  
If bit 3 (`QUESTIONABLE` summary bit) is set, then:
2. `STAT:QUES:EVENT?` (query `STATUS:QUESTIONABLE` register)  
If bit 10 (`QUESTIONABLE:LIMIT1` summary bit) is set, then:
3. Query `STAT:QUES:LIMIT1:EVENT?` (query `STATUS:QUESTIONABLE:LIMIT1` register)  
If bit 1 is set, then the first trace failed the limit check.



The SRQ is the only possibility for the instrument to become active on its own. Each controller program should set the instrument such that a service request is initiated in the case of malfunction. The program should react appropriately to the service request.

#### 5.5.4.2 Serial Poll

In a serial poll, the controller queries the `STATUS` Bytes of the devices in the bus system one after another. The query is made via interface messages, so it is faster than a poll by means of `*STB?`.

The serial poll method is defined in IEEE 488.1 and used to be the only standard possibility for different instruments to poll the status byte. The method also works for instruments which do not adhere to SCPI or IEEE 488.2.

The serial poll is mainly used to obtain a fast overview of the state of several instruments connected to the controller.

#### 5.5.4.3 Parallel Poll

In a parallel poll, up to eight instruments are simultaneously requested by the controller by means of a single command to transmit 1 bit of information each on the data lines, i.e., to set the data line allocated to each instrument to a logical "0" or "1".

In addition to the `SRE` register, which determines the conditions under which an SRQ is generated, there is a Parallel Poll Enable register (`PPE`). This register is `ANDed` with the `STB` bit by bit, considering bit 6 as well. The results are `ORed`, the result is possibly inverted and then sent as a response to the parallel poll of the controller. The result can also be queried without parallel poll by means of the command `*IST?`.

The parallel poll method is mainly used to find out quickly which one of the instruments connected to the controller has sent a service request. To this effect, SRE and PPE must be set to the same value.

#### 5.5.4.4 Query of an Instrument Status

Each part of any status register can be read by means of queries. There are two types of commands:

- The common commands `*ESR?`, `*IDN?`, `*IST?`, `*STB?` query the higher-level registers.
- The commands of the STATus system query the SCPI registers (e.g. `STATus:OPERation...`)

All queries return a decimal number which represents the bit pattern of the status register. This number is evaluated by the controller program.

Queries are usually used after an SRQ in order to obtain more detailed information on its cause.

#### Decimal representation of a bit pattern

The STB and ESR registers contain 8 bits, the SCPI registers 16 bits. The contents of a status register is keyed and transferred as a single decimal number. To make this possible, each bit is assigned a weighted value. The decimal number is calculated as the sum of the weighted values of all bits in the register that are set to 1.

Bits	0	1	2	3	4	5	6	7	...
Weight	1	2	4	8	16	32	64	128	...

Example: The decimal value  $40 = 32 + 8$  indicates that bits no. 3 and 5 in the status register (e.g. the QUESTIONable status summary bit and the ESB bit in the STB) are set.

#### 5.5.4.5 Error Queue

Each error state in the instrument leads to an entry in the error queue. The entries of the error queue are detailed plain text error messages that can be queried via remote control using `SYSTem:ERRor[:NEXT]?` or `SYSTem:ERRor:ALL?`. Each call of `SYSTem:ERRor[:NEXT]?` provides one entry from the error queue. If no error messages are stored there any more, the instrument responds with 0, "No error".

The error queue should be queried after every SRQ in the controller program as the entries describe the cause of an error more precisely than the status registers. Especially in the test phase of a controller program the error queue should be queried regularly since faulty commands from the controller to the instrument are recorded there as well.

### 5.5.5 Reset Values of the Status Reporting System

The table below indicates the effects of various commands upon the status reporting system of the R&S ZNC/ZND.

Event	Switching on supply voltage Power-On-Status-Clear		DCL, SDC (Device Clear, Selected Device Clear)	*RST or SYS-Tem:PRE-Set:ALL	STA-Tus:PRE-Set	*CLS
	0	1				
Effect	0	1				
Clear STB,ESR		yes				yes
Clear SRE,ESE		yes				
Clear PPE		yes				
Clear EVENT parts of the registers		yes				yes
Clear ENABLE parts of all OPERation-and QUESTionable registers, Fill ENABLE parts of all other registers with "1".		yes			yes	
Fill PTRansition parts with "1" Clear NTRansition parts		yes			yes	
Clear error queue	yes	yes				yes
Clear output buffer	yes	yes	yes	1)	1)	1)
Clear command processing and input buffer	yes	yes	yes			

1) Every command being the first in a command line, i.e. immediately following a <PROGRAM MESSAGE TERMINATOR> clears the output buffer.

## 5.6 LXI Configuration

LAN eXtensions for Instrumentation (LXI) is an instrumentation platform for measuring instruments and test systems that is based on standard Ethernet technology. LXI is intended to be the LAN-based successor to GPIB, combining the advantages of Ethernet with the simplicity and familiarity of GPIB.

### 5.6.1 LXI Classes and LXI Functionality

LXI-compliant instruments are divided into three classes, A, B and C, with the functionality of the classes hierarchically based one upon the other:



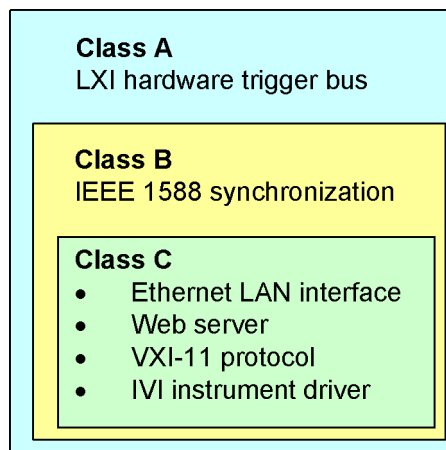

- **Class C** instruments are characterized by a common LAN implementation, including an ICMP ping responder for diagnostics, see [Ping Client](#). The instruments can be configured via the [LXI Browser Interface](#); a LAN Configuration Initialize (LCI) mechanism resets the LAN configuration. The LXI class C instruments shall also support automatic detection in a LAN via the VXI-11 discovery protocol and programming by means of IVI drivers.
- **Class B** adds IEEE 1588 Precision Time Protocol (PTP) and peer-to-peer communication to the base class. IEEE 1588 allows all instruments on the same network to automatically synchronize to the most accurate clock available and then provide time stamps or time-based synchronization signals to all instruments with exceptional accuracy.
- **Class A** instruments are additionally equipped with the eight-channel hardware trigger bus (LVDS interface) defined in the LXI standard.

Instruments of classes A and B can generate and receive software triggers via LAN messages and communicate with each other without involving the controller.

The network analyzer complies with LXI class C. In addition to the general class C features described above, it provides the following LXI-related functionality:

- Integrated "Remote LXI" dialog for LXI activation and reset of the LAN configuration (LAN Configuration Initialize, LCI); see [Chapter 4.6.7, "Remote LXI \(Dialog\)"](#), on page 348.



For information about the LXI standard refer to the LXI website at <http://www.lxistandard.org>. See also "News from Rohde & Schwarz, issue no. 190 - 2006/II".

## 5.6.2 LXI Browser Interface

The instrument's LXI browser interface works correctly with all W3C compliant browsers. Typing the instrument's host name or IP address in the address field of the browser on your PC, e.g.

"http://10.113.10.203"

opens the "Home" page (welcome page).



The instrument home page displays the device information required by the LXI standard including the VISA resource string in read-only format. The "Device Indicator" toggle button causes the LXI symbol in the status bar of the analyzer to blink (if active) and updates the "Host Name". A green LXI status symbol indicates that a LAN connection has been established; a red symbol indicates that no LAN cable is connected. The "Device Indicator" setting is not password-protected.



The navigation pane of the browser interface contains the following control elements:

- "LXI > Lan Configuration" opens the LAN Configuration pages; see [Chapter 5.6.3, "LAN Configuration"](#), on page 394.
- "LXI > Status" displays information about the LXI status of the instrument.
- "Help" provides a link to the Rohde & Schwarz home page.
- The remaining tabs are for future extensions.

### 5.6.3 LAN Configuration

Comprises the following navigation entries.

- [IP Configuration](#)..... 395
- [Advanced Config](#)..... 395
- [Ping Client](#)..... 396

### 5.6.3.1 IP Configuration

The LAN configuration parameters required by the LXI standard can be accessed via the navigation entry "IP Configuration".

The screenshot shows the "LAN Parameters" configuration page. The left sidebar contains navigation options: LXI, Home, Lan Configuration (with sub-items IP Configuration, Advanced Config, Ping Client), Status, Help, www.rohde-schwarz.com, Diagnostics (with sub-item SCPI Remote Trace), Instrument Control (with sub-items File Download, File Upload, Web Control), and License Management. The main content area is titled "LAN Parameters" and contains the following fields:

- Hostname: mu604968.rsint.net
- Domain: rsint.net
- Description: Vector Network Analyzer
- TCP/IP Mode: DHCP + Auto IP Address (dropdown menu)
- IP Address: 10.113.10.38
- Subnet Mask: 255.255.0.0
- Default Gateway: 10.113.0.1
- DNS Server(s): 10.0.2.166 and 10.0.23.159
- Dynamic DNS:  Disabled,  Enabled

At the bottom, there is a "Submit" button and a password field with the text "(Password required!)" next to it.

The "TCP/IP Mode" configuration field controls how the IP address for the instrument gets assigned. For the manual configuration mode, the static IP address, subnet mask, and default gateway are used to configure the LAN. The automatic configuration mode uses DHCP server or Dynamic Link Local Addressing (Automatic IP) to obtain the instrument IP address.



#### Password protection

Changing the LAN configuration is password-protected. The password reads **LxiWe-blfc** (notice upper and lower case characters). This password cannot be changed in the current software version.

### 5.6.3.2 Advanced Config

The navigation entry "Advanced Config" provides LAN settings that are not declared mandatory by the LXI standard.

The screenshot shows the 'LAN Parameters' configuration page. The sidebar on the left contains the following menu items: LXI, Home, Lan Configuration (with sub-items IP Configuration, Advanced Config, Ping Client), Status, Help (with sub-item www.rohde-schwarz.com), Diagnostics (with sub-item SCPI Remote Trace), Instrument Control (with sub-items File Download, File Upload, Web Control), and License Management. The main content area is titled 'LAN Parameters' and contains the following settings:

- Negotiation:** A dropdown menu set to 'Auto Detect'.
- ICMP Ping:** Radio buttons for 'Disabled' and 'Enabled', with 'Enabled' selected.
- VXI-11 Discovery:** Radio buttons for 'Disabled' and 'Enabled', with 'Disabled' selected.
- mDNS and DNS-SD:** Radio buttons for 'Disabled' and 'Enabled', with 'Disabled' selected.

At the bottom right, there is a password field with a 'Submit' button and the text '(Password required!)'.

The advanced LAN configuration parameters are used as follows:

- "Negotiation": The negotiation configuration field provides different Ethernet speed and duplex mode settings. In general, the "Auto Detect" mode is sufficient.
- "ICMP Ping" must be enabled to use the ping utility.
- "VXI-11 Discovery" and "mDNS and DNS-SD" are protocols which can be used for discovery of the instrument in the LAN. The VXI-11 discovery mechanism is a requirement on LXI devices from the first revision of the standard. Support for the multicast DNS (mDNS) and DNS-SD (DNS Service Discovery) mechanisms has been introduced as a requirement in version 1.3 of the standard. The R&S ZNC/ZND supports both discovery mechanisms.



### Password protection

Changing the LAN configuration is password-protected. The password reads **LxiWebIfc** (notice upper and lower case characters). This password cannot be changed in the current software version.

#### 5.6.3.3 Ping Client

Ping is a utility that verifies the connection between the LXI-compliant instrument and another device. The ping is initiated from the instrument. It uses the ICMP echo request and echo reply packets to determine whether the LAN connection to another device is functional. Ping is useful for diagnosing IP network or router failures.

The ping utility is not password-protected. To initiate a ping at the instrument:

1. Ensure that "ICMP Ping" is enabled (see [Advanced Config](#)).
2. Enter the IP address of the second device into the "Destination Address" field (e.g. 10.123.10.0).
3. Click Submit.

**LXI**

- Home
- Lan Configuration
- Status

**Help**

- [www.rohde-schwarz.com](http://www.rohde-schwarz.com)

**Diagnostics**

- SCPI Remote Trace

**Instrument Control**

- File Download
- File Upload
- Web Control

**License Management**

- Manage Licenses

**Ping Parameter**

**Destination Address**

**Result**

```
Pinging 10.113.10.0 with 32 bytes of data:  
Reply from 10.113.10.0: bytes=32 time<1ms TTL=128  
Reply from 10.113.10.0: bytes=32 time<1ms TTL=128  
Reply from 10.113.10.0: bytes=32 time<1ms TTL=128  
Reply from 10.113.10.0: bytes=32 time<1ms TTL=128  
Ping statistics for 10.113.10.0:  
    Packets: Sent = 4, Received = 4, Lost = 0 (0%  
loss),
```

## 6 Command Reference

This chapter describes all common commands and SCPI commands implemented by the analyzer.



### Validity of the command set

The commands reported in this chapter are valid for vector network analyzers with any number of ports. However, some of the program examples assume that more than 2 ports are available. In most cases, a simple adjustment of the port suffixes or parameters will ensure compatibility with 2-port analyzers.

### Compatibility with R&S ZVB and older instruments

The SCPI command set for the R&S ZNC/ZND vector network analyzer has been designed for compatibility with network analyzers R&S ZVA and R&S ZVB. A special subset of commands has been implemented for compatibility with older analyzers of the R&S ZVR family. These commands are listed in [Chapter 6.4, "R&S ZVR/ZVAB Compatible Commands"](#), on page 744.

If you want to make full use of the R&S ZNC/ZND features but do not need R&S ZVR compatibility, you should use the commands listed in [Chapter 6.3, "SCPI Command Reference"](#), on page 401.

## 6.1 Special Terms and Notation

This section explains the meaning of special syntax elements used in the SCPI command reference sections.

The following information is provided in the reference sections:

- Complete command syntax and parameter list
- Description of the command and its relationship with other commands
- List and description of the parameters with their numerical ranges, default values and default units
- Supported command types (setting command, query). If nothing is mentioned, the command can be used to write **and** read data (setting command and query).
- Program example

The SCPI conformance information is stated at the beginning of each section. Unless otherwise stated, the commands are device-specific.

The commands are generally arranged in alphabetical order. Commands with similar function (e.g. a pair of `...START` and `...STOP` commands) may be described in a common section, which in some instances disrupts the strict alphabetical order.

### 6.1.1 Upper/Lower Case

Upper/lower case characters characterize the long and short form of the mnemonics in a command. The short form consists of all upper-case characters, the long form of all upper case plus all lower case characters. It is recommended to use either the short form or the long form; mixed forms are not always recognized. The R&S ZNC/ZND itself does not distinguish upper case and lower case characters.

### 6.1.2 Special Characters

The following special characters are frequently used in the command description:

- **|** A vertical stroke characterizes alternative parameter settings. Only one of the parameters separated by | must be selected.
- **[ ]** Mnemonics in square brackets can be omitted when composing the command header. The complete command must be recognized by the instrument for reasons of compatibility with the SCPI standard. Parameters in square brackets are optional as well. They may be used in some application contexts, omitted in others.
- **{ }** Braces or curly brackets enclose one or more parameters that may be included zero or more times.

### 6.1.3 Parameters

Many commands are supplemented by a parameter or a list of parameters. Parameters either provide alternative options (setting a or setting b or setting c ..., see special character "|"), or they form a list separated by commas (setting x, y).

- **<Parameter1>, <Parameter2>...:** In the command tables and lists, parameters are generally described by a name (Parameter1, Parameter2...) written in angle brackets (<>). In an application program, <Parameter1>, <Parameter2>... must be replaced by one of the possible settings reported in the detailed parameter description.

**Example:** `CONTRol:AUXiliary:C[:DATA] <DecValue>`

with `<DecValue> = 0 to 255`

--> possible command syntax: `CONTRol:AUXiliary:C:DATA 1`

- **NAN (Not A Number)** (as a returned value) is generally used to represent missing data, e.g. if a portion of a trace has not been acquired yet. It is also returned after invalid mathematical operations such as division by zero. As defined in the SCPI standard, NAN is represented as 9.91 E 37.
- **INV (INValid)** is returned e.g. if a limit check is performed without defining the appropriate tolerance values.

### 6.1.4 Numeric Suffixes

Symbols in angular brackets (<Ch>, <Chn>, <Mk>...) are numeric suffixes. Numeric suffixes are replaced by integer numbers to distinguish various items of the same type.

The analyzer provides numeric suffixes for channels, traces, ports, markers etc. If unspecified, a numeric suffix is replaced by 1.

The marker suffix must be in the range between 1 and 10, the number of ports depends on the analyzer model. No restrictions apply to channel, trace, and diagram suffixes.

In remote control, one active trace can be selected for each channel; see [Chapter 5.3.2, "Active Traces in Remote Control"](#), on page 372. This concept simplifies the remote control command syntax, because it allows the active trace in a particular channel to be referenced by means of the channel suffix. To keep the syntax transparent, <Ch> is used for channel settings (it denotes the configured channel), whereas <Chn> is used for trace settings (it denotes the active trace in the channel).

## 6.2 Common Commands

Common commands are described in the IEEE 488.2 (IEC 625-2) standard. These commands have the same effect and are employed in the same way on different devices. The headers of these commands consist of "\*" followed by three letters. Many common commands are related to the status reporting system; see [Chapter 5.5, "Status Reporting System"](#), on page 379.

**Table 6-1: List of common commands**

Command	Parameters / Remarks	Short Description
<b>*CLS</b> CLear Status	– / no query	Sets the status byte (STB), the standard event register (ESR) and the EVENT part of the QUEStionable and the OPERation register to zero. The command does not alter the mask and transition parts of the registers. It clears the output buffer and the tooltip error messages for remote control.
<b>*ESE</b> Event Status Enable	0...255	Sets the event status enable register to the value indicated. The query *ESE? returns the contents of the event status enable register in decimal form.
<b>*ESR?</b> Event Status Read	– / query only	Returns the contents of the event status register in decimal form (0 to 255) and subsequently sets the register to zero.
<b>*IDN?</b> IDentification Query	– / query only	Queries the instrument identification string of the R&S ZNC/ZND, including the manufacturer, the instrument type, its serial number, and the software revision. The response is of the form "Rohde&Schwarz,ZNC<Max. Freq>-<Ports>Port,<Serial_no>,<FW_Version> (e.g. Rohde-Schwarz,ZNC8-2Port, 1311.6004.12,12345,1.10.12)".  The IDN information is editable; see "Define *IDN? + *OPT?" on page 347.
<b>*IST?</b> Individual SStatus query	– / query only	Returns the contents of the IST flag in decimal form (0   1). The IST-flag is the status bit which is sent during a parallel poll.
<b>*OPC</b> OPeration Complete	–	Sets bit 0 in the event status register when all preceding commands have been executed. This bit can be used to initiate a service request. The query form writes a "1" into the output buffer as soon as all preceding commands have been executed. This is used for command synchronization.



Command	Parameters / Remarks	Short Description
<b>*OPT?</b> OPTion identification query	– query only	Queries the options included in the instrument and returns a list of the options installed. The response consists of arbitrary ASCII response data according to IEEE 488.2. The options are returned at fixed positions in a comma separated string. A zero is returned for options that are not installed. The OPT information is editable; see "Define *IDN? + *OPT?" on page 347.
<b>*PCB</b> Pass Control Back	0...30 / no query	Indicates the controller address to which GPIB bus control is returned after termination of the triggered action.
<b>*PRE</b> Parallel poll Register Enable	0...255	Sets parallel poll enable register to the value indicated. Query *PRE? returns the contents of the parallel poll enable register in decimal form.
<b>*PSC</b> Power on Status Clear	0   1	Determines whether the contents of the ENABLE registers is maintained or reset when the instrument is switched on. *PSC = 0 causes the contents of the status registers to be maintained. Thus a service request can be triggered on switching on in the case of a corresponding configuration of status registers ESE and SRE. *PSC = 1 resets the registers. Query *PSC? reads out the contents of the power-on-status-clear flag. The response can be 0 or 1.
<b>*RST</b> ReSeT	– / no query	Sets the instrument to a defined default status. The command is equivalent to <code>SYSTem:PRESet [:DUMMy]</code> . The *RST value of each command is reported in the reference description. See also <code>SYSTem:PRESet:SCOPE</code> .
<b>*SRE</b> Service Request Enable	0...255	Sets the service request enable register to the value indicated. Bit 6 (MSS mask bit) remains 0. This command determines under which conditions a service request is triggered. The query *SRE? returns the contents of the service request enable register in decimal form. Bit 6 is always 0.
<b>*STB?</b> STatus Byte query	– / query only	Reads the contents of the status byte in decimal form.
<b>*TRG</b> TRIGger	– / no query	Triggers all actions waiting for a trigger event. *TRG generates a manual trigger signal. This common command complements the <code>TRIGger...</code> commands of the analyzer.
<b>*WAI</b> WAI to continue	– / no query	Prevents servicing of the subsequent commands until all preceding commands have been executed and all signals have settled.

## 6.3 SCPI Command Reference

The following sections provide detailed reference information on the instrument control commands implemented by the R&S ZNC/ZND network analyzer.

- [ABORt Commands](#).....402
- [CALCulate Commands](#).....402
- [CONFIgure Commands](#).....491
- [CONTRol Commands](#).....499
- [DIAGnostic Commands](#).....508
- [DISPlay Commands](#).....509
- [FORMat Commands](#).....534
- [HCOPY Commands](#).....536
- [INITiate Commands](#).....540
- [INSTrument Commands](#).....543

• <a href="#">MEMory</a> .....	544
• <a href="#">MMEMory Commands</a> .....	546
• <a href="#">OUTPut Commands</a> .....	575
• <a href="#">PROGram Commands</a> .....	577
• <a href="#">[SENSE:] Commands</a> .....	581
• <a href="#">SOURce Commands</a> .....	678
• <a href="#">STATus Commands</a> .....	706
• <a href="#">SYSTem Commands</a> .....	710
• <a href="#">TRACe Commands</a> .....	734
• <a href="#">TRIGger Commands</a> .....	738

### 6.3.1 ABORt Commands

In general, `ABORt` . . . commands reset the trigger system and place all trigger sequences in the IDLE state. Any actions related to the trigger system that are in progress, such as a sweep or acquiring a measurement, shall also be aborted as quickly as possible.

---

#### ABORt

Aborts a running measurement and resets the trigger system.

In continuous sweep mode (`INITiate<Ch>:CONTinuous` on page 540 ON) the R&S ZNC/ZND automatically starts a new sweep.

**Usage:**                      Event

### 6.3.2 CALCulate Commands

The `CALCulate` . . . commands perform post-acquisition data processing. Functions in the `SENSE` subsystem are related to data acquisition, while the `CALCulate` subsystem operates on the data acquired by a `SENSE` function.

#### 6.3.2.1 CALCulate:CLIMits...

The `CALCulate:CLIMits` . . . commands control the composite limit check.

---

#### CALCulate:CLIMits:FAIL?

Returns a 0 or 1 to indicate whether or not a global, composite limit check on several traces has failed.

Since V2.20 of the R&S ZNC/ZND FW the result is automatically recalculated whenever a relevant setting is changed, i.e. a subsequent query will return the updated limit violation state.

- Example:**                    \*RST; CALC:LIM:CONT 1 GHZ, 2 GHZ  
 Define an upper limit line segment in the stimulus range between 1 GHz and 2 GHz, using default response values.  
 CALC:LIM:STAT ON; FAIL?  
 Switch the limit check on and query the result.  
 CALC:CLIM:FAIL?  
 Query the result for the composite limit check. As only one trace is tested, the response should be equal to the previous response.
- Usage:**                      Query only
- Manual operation:**        See "Global Check" on page 197

### 6.3.2.2 CALCulate:DATA...

The CALCulate:DATA... commands provide access to the results of a measurement.



#### Data format

The trace data is transferred in either ASCII or block data (REAL) format, depending on the FORMat[:DATA] setting. If block data format is used, it is recommended to select EOI as a receive terminator (SYSTem:COMMunicate:GPIB[:SELF]:RTERminator EOI).

CALCulate<Chn>:DATA.....	403
CALCulate<Ch>:DATA:CHANnel:ALL?.....	406
CALCulate<Ch>:DATA:CALL.....	406
CALCulate:DATA:ALL?.....	407
CALCulate<Ch>:DATA:CALL:CATalog?.....	408
CALCulate:DATA:DALL?.....	408
CALCulate<Ch>:DATA:CHANnel:DALL?.....	408
CALCulate<Chn>:DATA:NSWeep:COUNT?.....	409
CALCulate<Chn>:DATA:NSWeep:FIRSt?.....	409
CALCulate<Chn>:DATA:NSWeep[:LAST]?.....	410
CALCulate<Ch>:DATA:SGRoup?.....	411
CALCulate<Chn>:DATA:STIMulus?.....	411
CALCulate:DATA:TRACe.....	411

**CALCulate<Chn>:DATA <Format>, <Data>...**

**CALCulate<Chn>:DATA? <Format>**

The query reads the response values of the selected channel's active trace or reads error terms of the selected channel.

The "set command" either imports formatted or unformatted trace data to the selected channel's active trace (data access point 3 or 2 in [Figure 3-1](#)) or writes error terms of the selected channel.

**Note**

- The data format is parameter-dependent; see tables below. The unit is the default unit of the measured parameter; see `CALCulate<Ch>:PARAmeter:SDEFine`.
- Unformatted trace data (SDATa) can only be imported to memory traces
- Formatted trace data (FDATa) can only be imported to "live" traces if the related channel is in single sweep mode (`INITiate<Ch>:CONTInuousOFF`). Before the import, the target trace must be prepared according to the settings used during export. Any request for new data from the hardware ("Restart Sweep" in single sweep mode or switching to continuous sweep mode) discards imported data and switches back the display to measured data.

**Suffix:**

<Chn> Channel number used to identify the active trace. If unspecified the numeric suffix is set to 1.

**Parameters:**

<Data> Trace data either in ASCII or block data format, depending on the current `FORMat[:DATA]` setting.

**Parameters for setting and query:**

<Format> FDATa | SDATa | MDATa | NCDat | UCData | SCORr1 | SCORr2 | SCORr3 | SCORr4 | SCORr5 | SCORr6 | SCORr7 | SCORr8 | SCORr9 | SCORr10 | SCORr11 | SCORr12 | SCORr13 | SCORr14 | SCORr15 | SCORr16 | SCORr17 | SCORr18 | SCORr19 | SCORr20 | SCORr21 | SCORr22 | SCORr23 | SCORr24 | SCORr25 | SCORr26 | SCORr27

See list of parameters below.

**Example:**

```
*RST; SWE:POIN 20
```

Create a trace with 20 sweep points, making the created trace the active trace of channel 1 (omitted optional mnemonic `SENSe1`).

```
CALC:DATA? FDAT
```

Query the 20 response values of the created trace. In the `FDATa` setting, 20 comma-separated ASCII values are returned.

```
CALC:DATA:STIM?
```

Query the 20 stimulus values of the created trace. 20 comma-separated ASCII values are returned.

```
CALC2:PAR:SDEF 'Trc2', 'S11'
```

Create a second trace in a new channel no. 2. The second trace does not become the active trace and is not displayed.

```
CALC:DATA:TRAC? 'Trc2', FDAT
```

Query the response values of the second (non-active) trace. 20 comma-separated ASCII values are returned.

```
CALC:DATA:ALL? FDAT
```

Query the response values of all traces. 40 comma-separated ASCII values are returned.

**Example:****Writing memory traces**

```
*RST; SWE:POIN 3
```

Create a data trace 'Trc1' with 3 sweep points, making the created trace the active trace of channel 1 (omitted optional mnemonic SENSE1).

```
TRAC:COPY 'MemTrc1','Trc1'; :CALC:PAR:SEL 'MemTrc1'
```

Copy the data trace to a memory trace and select the memory trace as an active trace.

```
CALC:DATA SDAT, 1,2, 3,4, 5,6
```

Write numbers (1,2), (3,4), (5,6) to the memory trace.

```
CALC:DATA? SDAT
```

Query the memory trace. The response is 1,2,3,4,5,6.

```
FORM REAL, 32
```

Change the data format to 4-byte block data.

```
CALC:DATA SDAT, #224123456789012345678901234
```

Write 24 bytes (= 4 \* 2 \* 3 bytes) of data to the memory trace.

The following parameters are related to trace data (see also diagram in [Chapter 3.1.5, "Data Flow"](#), on page 18):

**Table 6-2: Data format identifiers used in the CALCulate:DATA... commands**

FDATA	Formatted trace data, according to the selected trace format (CALCulate<Ch>:FORMat). 1 value per trace point for Cartesian diagrams, 2 values for polar diagrams.
SDATA	Unformatted trace data: Real and imaginary part of each measurement point. 2 values per trace point irrespective of the selected trace format. The trace mathematics is not taken into account.
MDATA	Unformatted trace data (see SDATA) after evaluation of the trace mathematics.
NCDATA	Factory calibrated trace data: the values are obtained right after applying the factory calibration but before applying a user-defined calibration (if any). Offset and impedance normalization will not be performed.
UCDATA	Uncalibrated trace data. Note that the respective trace must represent a wave quantity or ratio. Otherwise an error occurs.

The following parameters denote the error terms generated during a calibration.

**Table 6-3: Error terms in the CALCulate:DATA... commands**

Error Term	Description	Receive Ports (S-parameter)
SCORr1, ..., SCORr12	2-port error terms; see <a href="#">[SENSE&lt;Ch&gt;: ]CORRection:DATA</a> .	1 and 2 (S11, S12, S21, S22)
SCORr13	Directivity	3 (S33)
SCORr14	Source match	3 (S33)
SCORr15	Reflection tracking	3 (S33)
SCORr16	Isolation	3 (S31)
SCORr17	Load match	3 (S31)

Error Term	Description	Receive Ports (S-parameter)
SCORr18	Transmission tracking	3 (S13)
SCORr19	Isolation	1 (S13)
SCORr20	Load match	1 (S13)
SCORr21	Transmission tracking	1 (S13)
SCORr22	Isolation	3 (S32)
SCORr23	Load match	3 (S32)
SCORr24	Transmission tracking	3 (S32)
SCORr25	Isolation	2 (S23)
SCORr26	Load match	2 (S23)
SCORr27	Transmission tracking	2 (S23)

**Note:** The error terms are channel-specific; they apply to the active calibration of channel no. <Chn> or to the factory calibration (if no channel calibration is active). For the factory calibration, the query form is allowed only (no change of factory calibration data).

**Tip:** Use the generalized command `[SENSe<Ch>:]CORRection:CDATa` to read or write error terms for arbitrary analyzer ports. For additional programming examples refer to [Chapter 7.2.5.2, "Saving and Recalling Error Terms"](#), on page 793.

---

#### **CALCulate<Ch>:DATA:CHANnel:ALL? <Format>**

Reads the current response values of all traces of the selected channel.

##### **Suffix:**

<Ch> Channel number

##### **Query parameters:**

<Format> FDATa | SDATa | MDATa  
Output format for the S-parameter data, see [CALCulate<Chn>:DATA](#).

##### **Return values:**

<Data> Trace data either in ASCII or block data format, depending on the current `FORMat [:DATA]` setting.

**Usage:** Query only

---

#### **CALCulate<Ch>:DATA:CALL <Format>, <Data>...**

The query reads the current response values of all S-parameter data traces at channel <Ch>'s data access point <DACPoint>.

If a full n-port system error correction (TOSM, TOM, TRL ...) is active in the referenced channel, the command reads the full nxn S-matrix of the calibrated ports (there is no need to create or display the S-parameter traces). Use `CALCulate<Ch>:DATA:CALL:CATalog?` to query the available traces.

The "set direction" allows to import measurement data at "Fixture Simulation Input" data access point (no. 1 in [Figure 3-1](#)).

#### Note

- Importing data is only supported in single sweep mode (`INITiate<Ch>:CONTinuousOFF`)
- Before importing data, the channel must match to the settings used during export; especially the user calibration and the configuration of balanced ports, stimulus axis, switch matrix configuration, etc. must match
- After importing data, "downstream" parameters in the data flow can be changed and their effect is shown directly
- Any request for new data from the hardware ("Restart Sweep" in single sweep mode or switching to continuous sweep mode) discards imported data and switches back the display to measured data

#### Suffix:

<Ch> Channel number

#### Parameters:

<Format> SDATa | FSIData  
 SDATa: Output as unformatted trace data; see `CALCulate<Chn>:DATA`. Query only.  
 FSIData: Output or input at "Fixture Simulation Input" data access point.

<Data> Trace data either in ASCII or block data format, depending on the current `FORMat[:DATA]` setting.  
 The column order must match the one used during export.

#### Example:

Suppose that a TOSM calibration for ports 1 and 2 is active in channel no. 1.  
`CALCulate:DATA:CALL:CATalog?`  
 Query the traces available for `CALCulate<Ch>:DATA:CALL?`.  
 The response is 'S11, S12, S21, S22'.  
`CALCulate:DATA:CALL? SDATa`  
 Return the complex response values of all traces. The traces in the catalog list are read one after another: The response array contains n (number of points) pairs of real and imaginary values for S<sub>11</sub>, followed by n pairs of values for S<sub>12</sub>, S<sub>21</sub>, and S<sub>22</sub>.

---

**CALCulate:DATA:ALL?** <Format>[, <RecallSet>]

Reads the current response values of all traces of the referenced recall set.

**Query parameters:**

<Format> FDATa | SDATa | MDATa  
Output format for the S-parameter data, see [CALCulate<Chn>:DATA](#).

<RecallSet> Recall set name; if omitted the active recall set is used

**Return values:**

<Data> Response values either in ASCII or block data format, depending on the current [FORMat\[:DATA\]](#) setting.

**Example:** See [CALCulate<Chn>:DATA](#)

**Usage:** Query only

**CALCulate<Ch>:DATA:CALL:CATalog?**

Returns all traces which are available for [CALCulate<Ch>:DATA:CALL](#) in channel no. <Ch>. The response is a string parameter with all S-parameter traces in the current channel or in the active system error correction; see example.

**Suffix:**

<Ch> Channel number

**Example:** See [CALCulate<Ch>:DATA:CALL](#)

**Usage:** Query only

**CALCulate:DATA:DALL? <Format>**

Reads the current response values of all data traces of the current recall set. Use [CALCulate:DATA:ALL?](#) to query data traces and memory traces.

**Query parameters:**

<Format> FDATa | SDATa | MDATa  
Output format for the S-parameter data, see [CALCulate<Chn>:DATA](#).

**Return values:**

<Data> Response values either in ASCII or block data format, depending on the current [FORMat\[:DATA\]](#) setting.

**Example:** Analogous to [CALCulate:DATA:DALL?](#); see [CALCulate<Chn>:DATA](#).

**Usage:** Query only

**CALCulate<Ch>:DATA:CHANnel:DALL? <Format>**

Reads the current response values of all data traces of the selected channel. Use [CALCulate<Ch>:DATA:CHANnel:ALL?](#) to query data traces and memory traces.



<b>Suffix:</b>	
<Ch>	Channel number
<b>Query parameters:</b>	
<Format>	FDATa   SDATa   MDATa Output format for the S-parameter data, see <a href="#">CALCulate&lt;Chn&gt;:DATA</a> .
<b>Return values:</b>	
<Data>	Trace data either in ASCII or block data format, depending on the current <a href="#">FORMat [:DATA]</a> setting.
<b>Usage:</b>	Query only

**CALCulate<Chn>:DATA:NSweep:COUNT?**

Reads the number of completed sweeps in single sweep mode ([INITiate<Ch>:CONTinuousOFF](#)). The trace can be any of the traces acquired during the single sweep cycle.

**Tip:**

This command can only be used for [\[SENSe<Ch>:\]SWEep:COUNT](#) > 1.

<b>Suffix:</b>	
<Chn>	Channel number used to identify the active trace.
<b>Example:</b>	See <a href="#">CALCulate&lt;Chn&gt;:DATA:NSweep:FIRSt?</a>
<b>Usage:</b>	Query only

**CALCulate<Chn>:DATA:NSweep:FIRSt? <Format>, <FwCount>[, <FwCountEnd>]**

Reads the response values of a trace or a consecutive group of traces acquired in single sweep mode ([INITiate<Ch>:CONTinuousOFF](#)).

**Tip:**

This command can only be used for [\[SENSe<Ch>:\]SWEep:COUNT](#) > 1.

<b>Suffix:</b>	
<Chn>	Channel number used to identify the active trace.
<b>Query parameters:</b>	
<Format>	SDATa Read unformatted sweep data (fixed parameter): Returns the real and imaginary part of each measurement point (2 values per trace point irrespective of the selected trace format).
<FwCount>	Number of first sweep to be read. 1 denotes the first sweep acquired, 2 denotes the second and so forth. The sweep count in single sweep mode is defined via <a href="#">[SENSe&lt;Ch&gt;:]SWEep:COUNT</a> . Range: 1 to sweep count

<FwCountEnd> Number of last sweep to be read. If this parameter is omitted, it is implicitly set to <FwCount> (a single sweep is read).

Range: <FwCount> to sweep count

**Return values:**

<Data> Response values either in ASCII or block data format, depending on the current `FORMat [:DATA]` setting.

**Example:**

```
SWE:COUN 10
```

Define the number of sweeps (10) to be measured in single sweep mode.

```
INIT:CONT OFF; :INIT;
```

Activate single sweep mode and start a single sweep sequence in channel no. 1. No synchronization is necessary.

```
if (CALC:DATA:NSW:COUN? > 4)
```

```
CALC:DATA:NSW:FIRS? SDAT, 5
```

Wait until 5 sweeps have been measured, then query the results of the 5<sup>th</sup> sweep.

See also [Chapter 7.2.4.3, "Retrieving the Results of Previous Sweeps"](#), on page 790.

**Usage:**

Query only

**CALCulate<Chn>:DATA:NSweep[:LAST]? <Format>, <RvCount>**

Reads the response values of a trace acquired in single sweep mode (`INITiate<Ch>:CONTinuousOFF`). The trace can be any of the traces acquired during the single sweep cycle.

**Tip:**

- This command can only be used for `[SENSe<Ch>:]SWEep:COUNT > 1`.
- Ensure that the single sweep is terminated before using this command, otherwise the results of the trace count will be unpredictable (see example below). Alternatively, use the `CALCulate<Chn>:DATA:NSweep:FIRSt?` command.

**Suffix:**

<Chn> Channel number used to identify the active trace.

**Query parameters:**

<Format> SDATa

Read unformatted sweep data (fixed parameter): Returns the real and imaginary part of each measurement point (2 values per trace point, irrespective of the selected trace format).

<RvCount>

Number of sweep to be read. 1 denotes the last sweep acquired, 2 denotes the second-last and so forth.

Range: 1 to sweep count defined via `[SENSe<Ch>:]SWEep:COUNT`

**Example:** `SWE:COUN 10`  
 Define the number of sweeps (10) to be measured in single sweep mode.  
`INIT:CONT OFF; :INIT; *OPC?`  
 Activate single sweep mode and start a single sweep sequence in channel no. 1. Wait until the single sweep sequence is complete.  
`CALC:DATA:NSW? SDAT, 3`  
 Query the results of the 8<sup>th</sup> sweep.  
 See also [Chapter 7.2.4.3, "Retrieving the Results of Previous Sweeps"](#), on page 790.

**Usage:** Query only

### **CALCulate<Ch>:DATA:SGRoup? <Format>**

Reads the current response values of all S-parameters associated to a group of logical ports (S-parameter group). The S-parameter group must be created before using [CALCulate<Ch>:PARAMeter:DEFine:SGRoup](#).

**Suffix:**

<Ch> Channel number of the previously defined S-parameter group.

**Query parameters:**

<Format> FDATa | SDATa | MDATa  
 Output format for the S-parameter data, see [CALCulate<Chn>:DATA](#) on page 403.

**Example:** See [CALCulate<Ch>:PARAMeter:DEFine:SGRoup](#)

**Usage:** Query only

### **CALCulate<Chn>:DATA:STIMulus?**

Reads the stimulus values of the active data or memory trace.

**Suffix:**

<Chn> Channel number used to identify the active trace.

**Example:** See [CALCulate<Chn>:DATA](#)

**Usage:** Query only

### **CALCulate:DATA:TRACe <TraceName>, <Format>, <Data>...**

The query gets the trace data of an arbitrary (not necessarily the active) trace, referenced by its trace name <TraceName>.

The "set direction" allows to import formatted or unformatted trace data to an existing trace (data access point 3 or 2 in [Figure 3-1](#)).

**Note**

- Unformatted trace data (SDATa) can only be imported to memory traces

- Formatted trace data (FDATa) can only be imported to "live" traces if the related channel is in single sweep mode (`INITiate<Ch>:CONTinuousOFF`). Before the import, the target trace must be prepared according to the settings used during export. Any request for new data from the hardware ("Restart Sweep" in single sweep mode or switching to continuous sweep mode) discards imported data and switches back the display to measured data.

**Parameters:**

<TraceName>	String parameter containing the trace name
<Format>	FDATa   SDATa   MDATa   NCDatA   UCData Data format; see <a href="#">Table 6-2</a> .
<Data>	Trace data for FDATa   SDATa import either in ASCII or block data format, depending on the current <code>FORMat[:DATA]</code> setting. The column order must match the one used during export.

**Example:** See `CALCulate<Chn>:DATA`.

**6.3.2.3 CALCulate:DLINe...**

The `CALCulate:DLINe...` commands control the horizontal line used to mark and retrieve response values (display line).

<code>CALCulate&lt;Chn&gt;:DLINe.....</code>	412
<code>CALCulate&lt;Chn&gt;:DLINe:STATe.....</code>	412

**CALCulate<Chn>:DLINe <Position>**

Defines the position (response value) of the horizontal line.

**Suffix:**

<Chn> Channel number used to identify the active trace.

**Parameters:**

<Position> See list of parameters below.  
Default unit: NN

**Example:**

```
*RST; :CALC:DLIN 10
Define the position of the horizontal line in the default dB Mag
diagram at +10 dB.
CALC:DLIN:STAT ON
Display the defined horizontal line.
```

**Manual operation:** See "[Response Value](#)" on page 210

**CALCulate<Chn>:DLINe:STATe <Boolean>**

Switches the horizontal line on or off.

**Suffix:**

<Chn> Channel number used to identify the active trace.

**Parameters:**

<Boolean> ON | OFF - horizontal line on or off  
 \*RST: OFF

**Example:** See `CALCulate<Chn>:DLINe`

**Manual operation:** See "Horizontal Line" on page 210

**6.3.2.4 CALCulate:FILTer[:GATE]...**

The `CALCulate:FILTer[:GATE]...` commands define the properties of the time gate which is used to optimize the time domain response.

<code>CALCulate:FILTer[:GATE]:TIME:AOFFset</code> .....	413
<code>CALCulate&lt;Chn&gt;:FILTer[:GATE]:TIME:CENTer</code> .....	414
<code>CALCulate&lt;Chn&gt;:FILTer[:GATE]:TIME:DCHebyshev</code> .....	414
<code>CALCulate&lt;Chn&gt;:FILTer[:GATE]:TIME:SHAPE</code> .....	414
<code>CALCulate&lt;Chn&gt;:FILTer[:GATE]:TIME:SHOW</code> .....	415
<code>CALCulate&lt;Chn&gt;:FILTer[:GATE]:TIME:SPAN</code> .....	415
<code>CALCulate&lt;Chn&gt;:FILTer[:GATE]:TIME:STATE</code> .....	416
<code>CALCulate&lt;Chn&gt;:FILTer[:GATE]:TIME:START</code> .....	416
<code>CALCulate&lt;Chn&gt;:FILTer[:GATE]:TIME:STOP</code> .....	416
<code>CALCulate&lt;Chn&gt;:FILTer[:GATE]:TIME:WINDow</code> .....	417
<code>CALCulate&lt;Chn&gt;:FILTer[:GATE]:TIME[:TYPE]</code> .....	417

**CALCulate:FILTer[:GATE]:TIME:AOFFset <Boolean>**

Activates the operating mode where the time gate is moved in the opposite direction when the "Delay" setting is changed.

**Parameters:**

<Boolean> ON | OFF - enable or disable "Adjust Time Gate".  
 \*RST: OFF

**Example:**

```
*RST; :CALCulate1:TRANSform:TIME:STATE ON
CALCulate1:FILTer:GATE:TIME:STATE ON; SHOW ON
Activate time domain representation and a time gate in channel
no. 1. Display the time gate
CALCulate1:FILTer:GATE:TIME:START 2ns; STOP 3
ns
Restrict the time gate to the time interval between 2 ns and 3 ns.
CALCulate:FILTer:GATE:TIME:AOFFset ON
Activate an offset of the time gate according to a new delay set-
ting.
SENSE1:CORRection:EDELay1:TIME 1ns
Specify a 1 ns delay at port 1.
CALCulate1:FILTer:GATE:TIME:START?; STOP?
Query the time gate position. The response is 1E-009;2E-009.
```

**Manual operation:** See "Adjust Time Gate" on page 313

**CALCulate<Chn>:FILTer[:GATE]:TIME:CENTer** <CenterTime>

Defines the center time of the time gate.

**Suffix:**

<Chn> Channel number used to identify the active trace.

**Parameters:**

<CenterTime> Center time of the time gate  
 Range: -99.8999999 s to +99.8999999 s  
 Increment: 0.1 ns  
 \*RST: 1.5E-009 s  
 Default unit: s

**Example:**

```
*RST; :CALC:TRAN:TIME:STAT ON; :CALC:FILT:TIME:STAT ON
```

Reset the instrument and enable the time domain representation and the time gate.

```
CALC:FILT:TIME:CENT 0; SPAN 5ns
```

Set the center time to 0 ns and the time span to 5 ns.

**Manual operation:** See ["Axis Pair"](#) on page 180

**CALCulate<Chn>:FILTer[:GATE]:TIME:DCHebyshev** <SidebandSup>

Sets the sideband suppression for the Dolph-Chebyshev time gate. The command is only available if a Dolph-Chebyshev time gate is active ([CALCulate<Chn>:FILTer\[:GATE\]:TIME:WINDowDCHebyshev](#)).

**Suffix:**

<Chn> Channel number used to identify the active trace.

**Parameters:**

<SidebandSup> Sideband suppression  
 Range: 10 dB to 120 dB  
 Increment: 10 dB  
 \*RST: 32 dB  
 Default unit: dB

**Example:**

```
*RST; :CALC:FILT:TIME:WIND DCH
```

Reset the instrument and select a Dolph-Chebyshev time gate for filtering the data in the frequency domain.

```
CALC:FILT:TIME:DCH 25
```

Set the sideband suppression to 25 dB.

**Manual operation:** See ["Side Lobe Level"](#) on page 181

**CALCulate<Chn>:FILTer[:GATE]:TIME:SHAPE** <TimeGate>

Selects the time gate to be applied to the time domain transform.

**Tip:**

Use the generalized command `CALCulate<Chn>:FILTer[:GATE]:TIME:WINDow` if you wish to select a Dolph-Chebyshev time gate.

**Suffix:**

<Chn> Channel number used to identify the active trace.

**Parameters:**

<TimeGate> MAXimum | WIDE | NORMal | MINimum  
 MINimum - Steepest edges (rectangle)  
 WIDE - Normal gate (Hann)  
 NORM - Steep edges (Hamming)  
 Maximum - Maximum flatness (Bohman)  
 \*RST: WIDE

**Example:**

\*RST; :CALC:FILT:TIME:SHAP?  
 Reset the instrument and query the type of time gate used. The response is WIDE.

**Manual operation:** See "Shape" on page 181

**CALCulate<Chn>:FILTer[:GATE]:TIME:SHOW <Boolean>**

Enables or disables permanent display of the gate limits.

**Suffix:**

<Chn> Channel number used to identify the active trace.

**Parameters:**

<Boolean> ON - time gate permanently displayed  
 OFF - time gate hidden  
 \*RST: OFF

**Example:**

See `CALCulate<Chn>:FILTer[:GATE]:TIME:CENTer`

**Manual operation:** See "Show Range Limits" on page 180

**CALCulate<Chn>:FILTer[:GATE]:TIME:SPAN <Span>**

Defines the span of the time gate.

**Suffix:**

<Chn> Channel number used to identify the active trace.

**Parameters:**

<Span> Span of the time gate.  
 Range: 2E-012 s to 200 s  
 Increment: 0.1 ns  
 \*RST: 5E-009 s  
 Default unit: s

**Example:**

See `CALCulate<Chn>:FILTer[:GATE]:TIME:CENTer`

**Manual operation:** See "Axis Pair" on page 180

**CALCulate<Chn>:FILTer[:GATE]:TIME:STATe** <Boolean>

Determines whether the time gate for trace no. <Chn> is enabled.

**Suffix:**

<Chn> Channel number used to identify the active trace.

**Parameters:**

<Boolean> ON - time gate enabled  
OFF - time gate disabled  
\*RST: OFF

**Example:**

```
*RST; :CALC:TRAN:TIME:STAT?
CALC:FILT:TIME:STAT?
```

Reset the instrument, activating a frequency sweep, and query whether the default trace is displayed in the time domain and whether the time gate is enabled. The response to both queries is 0.

**Manual operation:** See ["Time Gate"](#) on page 180

**CALCulate<Chn>:FILTer[:GATE]:TIME:STARt** <StartTime>**CALCulate<Chn>:FILTer[:GATE]:TIME:STOP** <StopTime>

These commands define the start and stop times of the time gate, respectively.

**Suffix:**

<Chn> Channel number used to identify the active trace.

**Parameters:**

<StopTime> Start or stop time of the time gate.  
Range: -100 s to +99.999999999998 s (start time ) and  
-99.999999999998 s to +100 s (stop time)  
Increment: 0.1 ns  
\*RST: -1E-009 s (start time) to +4E-009 s (stop time)  
Default unit: s

**Example:**

```
*RST; :CALC:TRAN:TIME:STAT ON; :CALC:FILT:TIME:
STAT ON
```

Reset the instrument and enable the time domain representation and the time gate.

```
CALC:FILT:TIME:STAR 0; STOP 10ns; SHOW ON
```

Set the start time to 0 ns and the stop time to 10 ns and display the time gate permanently.

**Manual operation:** See ["Axis Pair"](#) on page 180

**Note:** If the start frequency entered is greater than the current stop frequency, the stop frequency is set to the start frequency plus the minimum frequency span ([CALCulate<Chn>:FILTer\[:GATE\]:TIME:SPAN](#)).

If the stop frequency entered is smaller than the current start frequency, the start frequency is set to the stop frequency minus the minimum frequency span.



**CALCulate<Chn>:FILTer[:GATE]:TIME:WINDow <TimeGate>**

Selects the time gate to be applied to the time domain transform.

**Suffix:**

<Chn> Channel number used to identify the active trace.

**Parameters:**

<TimeGate> RECT | HAMMing | HANNing | BOHMan | DCHebyshev  
 RECT - steepest edges (rectangle)  
 HANN - normal gate (Hann)  
 HAMMing - steep edges (Hamming)  
 BOHMan - minimum flatness (Bohman)  
 DCHebyshev - arbitrary gate shape (Dolph-Chebyshev)  
 \*RST: HANN

**Example:** See `CALCulate<Chn>:FILTer[:GATE]:TIME:DCHebyshev`

**Manual operation:** See "Shape" on page 181

**CALCulate<Chn>:FILTer[:GATE]:TIME[:TYPE] <TimeGateFilter>**

Selects the time gate filter type, defining what occurs to the data in the specific time region.

**Suffix:**

<Chn> Channel number used to identify the active trace-

**Parameters:**

<TimeGateFilter> BPASs | NOTCh  
 BPASs - band pass filter: Pass all information in specified time region and reject everything else.  
 NOTCh - notch filter: Reject all information in specified time region and pass everything else.  
 \*RST: BPASs

**Example:**

```
*RST; :CALC:FILT:TIME:STAT ON
Reset the instrument and enable the time gate.
CALC:FILT:TIME NOTCh
Select a notch filter in order to reject unwanted pulses.
```

**Manual operation:** See "Bandpass / Notch" on page 181

**6.3.2.5 CALCulate:FORMat...**

The `CALCulate:FORMat...` commands determine the post-processing of the measured data in order to obtain various display formats.

**CALCulate<Chn>:FORMat <Type>**

Defines how the measured result at any sweep point is post-processed and presented in the graphical display.

**Note:** The analyzer allows arbitrary combinations of display formats and measured quantities; see [Chapter 4.2.2, "Format Settings"](#), on page 150 and `CALCulate<Ch>:PARAmeter...` commands. Nevertheless, it is advisable to check which display formats are generally appropriate for an analysis of a particular measured quantity; see [Chapter 3.2.4.6, "Measured Quantities and Display Formats"](#), on page 47.

**Suffix:**

<Chn> Channel number used to identify the active trace.

**Parameters:**

<Type> MLINear | MLOGarithmic | PHASe | UPHase | POLar | SMITH | ISMith | GDELay | REAL | IMAGinary | SWR | COMPLex | MAGNitude

See list of parameters below.

\*RST: MLOGarithmic

**Example:**

```
CALC4:PAR:SDEF 'Ch4Tr1', 'S11'
```

Create channel 4 and a trace named Ch4Tr1 to measure the input reflection coefficient  $S_{11}$ . The trace becomes the active trace in channel 4.

```
CALC4:FORM MLIN; :DISP:WIND:TRAC2:FEED 'CH4TR1'
```

Calculate the magnitude of  $S_{11}$  and display it in a linearly scaled Cartesian diagram, assigning the trace number 2.

**Manual operation:** See ["dB Mag"](#) on page 151

Assume that the result at a sweep point is given by the complex quantity  $z = x + jy$ . The meaning of the parameters is as follows (see also table in `CALCulate<Chn>:MARKer<Mk>:FORMat` description):

MLINear	Calculate the magnitude of $z$ , to be displayed in a Cartesian diagram with a linear scale
MLOGarithmic	Calculate the magnitude of $z$ , displayed in a Cartesian diagram with a logarithmic scale
PHASe	Phase of $z$ , displayed in a Cartesian diagram with a linear vertical axis
UPHase	Unwrapped phase of $z$ , displayed in a Cartesian diagram with a linear vertical axis
POLar	Magnitude and phase, displayed in a polar diagram
SMITH	Magnitude and phase, displayed in a Smith chart
ISMith	Magnitude and phase, displayed in an inverted Smith chart
GDELay	Group delay, displayed in a Cartesian diagram
REAL	Real part ( $x$ ), displayed in a Cartesian diagram
IMAGinary	Imaginary part ( $y$ ), displayed in a Cartesian diagram
SWR	Standing Wave Ratio (SWR), displayed in a Cartesian diagram

COMPLex (for compatibility with R&S ZVR analyzers)	x, y, displayed in a polar diagram
MAGNitude (for compatibility with R&S ZVR analyzers)	Magnitude ( $\sqrt{x^2 + y^2}$ ), displayed in a Cartesian diagram with a logarithmic scale

---

**CALCulate<Chn>:FORMat:WQUType <Unit>**

Selects the physical unit of the displayed trace.

**Suffix:**

<Chn> Channel number used to identify the active trace.

**Parameters:**

<Unit> POWER | VOLTage  
 Power or voltage units  
 \*RST: POWER

**Example:**

```
CALC4:PAR:SDEF 'Ch4Tr1', 'b1'
```

Create channel 4 and a trace named Ch4Tr1 to measure the wave quantity  $b_1$ . The trace becomes the active trace in channel 4.

```
CALC4:FORM:WQUT VOLT
```

Select voltage units for the created trace (identified by the suffix 4).

**Manual operation:** See "[Show as](#)" on page 142

### 6.3.2.6 CALCulate:GDAPerture...

The CALCulate:GDAPerture... commands configure the group delay measurement.

---

**CALCulate<Chn>:GDAPerture:SCOut <Steps>**

Defines an aperture for the calculation of the group delay as an integer number of frequency sweep steps.

**Suffix:**

<Chn> Channel number used to identify the active trace.

**Parameters:**

<Steps> Number of steps  
 Range: 1 to 10000  
 \*RST: 10

**Example:**

```
*RST; :CALC:FORM GDEL
```

Select group delay calculation for the active trace.

```
CALC:GDAP:SCO 15
```

Select an aperture of 15 steps.

**Manual operation:** See "[Aperture](#)" on page 153

### 6.3.2.7 CALCulate:LIMit...

The `CALCulate:LIMit...` commands define the limit lines and control the limit check.

<code>CALCulate&lt;Chn&gt;:LIMit:CIRClE:DATA</code> .....	420
<code>CALCulate&lt;Chn&gt;:LIMit:CIRClE:DISPlay[:STATe]</code> .....	421
<code>CALCulate&lt;Chn&gt;:LIMit:CIRClE:FAIL?</code> .....	421
<code>CALCulate:LIMit:CIRClE:FAIL:ALL?</code> .....	422
<code>CALCulate&lt;Chn&gt;:LIMit:CIRClE:SOUNd[:STATe]</code> .....	422
<code>CALCulate&lt;Chn&gt;:LIMit:CIRClE[:STATe]</code> .....	422
<code>CALCulate&lt;Chn&gt;:LIMit:CIRClE:CLear</code> .....	422
<code>CALCulate&lt;Chn&gt;:LIMit:CONTRol[:DATA]</code> .....	423
<code>CALCulate&lt;Chn&gt;:LIMit:CONTRol:SHIFt</code> .....	424
<code>CALCulate&lt;Chn&gt;:LIMit:DATA</code> .....	424
<code>CALCulate&lt;Chn&gt;:LIMit:DCIRClE:CLear</code> .....	425
<code>CALCulate&lt;Chn&gt;:LIMit:DCIRClE:DATA</code> .....	425
<code>CALCulate&lt;Chn&gt;:LIMit:DCIRClE:DISPlay[:STATe]</code> .....	425
<code>CALCulate&lt;Chn&gt;:LIMit:DCIRClE[:STATe]</code> .....	426
<code>CALCulate&lt;Chn&gt;:LIMit:DELeTe:ALL</code> .....	426
<code>CALCulate&lt;Chn&gt;:LIMit:DISPlay[:STATe]</code> .....	426
<code>CALCulate&lt;Chn&gt;:LIMit:FAIL?</code> .....	427
<code>CALCulate:LIMit:FAIL:ALL?</code> .....	427
<code>CALCulate&lt;Chn&gt;:LIMit:SEGMENT&lt;Seg&gt;:AMPLitude:START</code> .....	428
<code>CALCulate&lt;Chn&gt;:LIMit:SEGMENT&lt;Seg&gt;:AMPLitude:STOP</code> .....	428
<code>CALCulate&lt;Chn&gt;:LIMit:SEGMENT:COUNT?</code> .....	428
<code>CALCulate&lt;Chn&gt;:LIMit:SEGMENT&lt;Seg&gt;:STIMulus:START</code> .....	429
<code>CALCulate&lt;Chn&gt;:LIMit:SEGMENT&lt;Seg&gt;:STIMulus:STOP</code> .....	429
<code>CALCulate&lt;Chn&gt;:LIMit:SEGMENT&lt;Seg&gt;:TYPE</code> .....	430
<code>CALCulate&lt;Chn&gt;:LIMit:SOUNd[:STATe]</code> .....	430
<code>CALCulate&lt;Chn&gt;:LIMit:STATe</code> .....	430
<code>CALCulate&lt;Chn&gt;:LIMit:STATe:AREA</code> .....	431
<code>CALCulate&lt;Chn&gt;:LIMit:TTLout&lt;Pt&gt;[:STATe]</code> .....	431
<code>CALCulate&lt;Chn&gt;:LIMit:LOWer[:DATA]</code> .....	432
<code>CALCulate&lt;Chn&gt;:LIMit:UPPer[:DATA]</code> .....	432
<code>CALCulate&lt;Chn&gt;:LIMit:LOWer:FEED</code> .....	433
<code>CALCulate&lt;Chn&gt;:LIMit:UPPer:FEED</code> .....	433
<code>CALCulate&lt;Chn&gt;:LIMit:LOWer:SHIFt</code> .....	434
<code>CALCulate&lt;Chn&gt;:LIMit:UPPer:SHIFt</code> .....	434
<code>CALCulate&lt;Chn&gt;:LIMit:CLear</code> .....	434

---

**`CALCulate<Chn>:LIMit:CIRClE:DATA` <CenterX>, <CenterY>, <Radius>**

Defines a circle limit lines by its center coordinates and its radius.

**Suffix:**

<Chn> Channel number used to identify the active trace.

**Parameters:**

<CenterX>	Range: Virtually no restriction for center coordinates. *RST: 0 Default unit: NN
<CenterY>	Range: Virtually no restriction for center coordinates. *RST: 0 Default unit: NN
<Radius>	Range: Virtually no restriction for radius (use positive values). *RST: 1 Default unit: NN

**Example:** See `CALCulate<Chn>:LIMit:CIRClE[:STATe]`

**Manual operation:** See "Radius / Center X/Y" on page 208

**CALCulate<Chn>:LIMit:CIRClE:DISPlay[:STATe] <Boolean>**

Displays or hides the circle limit line associated to the active trace.

**Suffix:**

<Chn> Channel number used to identify the active trace.

**Parameters:**

<Boolean> ON | OFF - Circle limit line on or off.  
\*RST: OFF

**Example:** \*RST; CALCulate:LIMit:CIRClE:DATA 0, 0, 0.5  
Define a circle limit line centered around the origin of the polar diagram, assigning a radius of 0.5 U.  
CALCulate:FORMat POLar  
CALCulate:LIMit:CIRClE:DISPlay ON  
Activate a polar diagram and show the circle limit line in the diagram.

**Manual operation:** See "Show Limit Circle" on page 206

**CALCulate<Chn>:LIMit:CIRClE:FAIL?**

Returns a 0 or 1 to indicate whether or not the circle limit check has failed. 0 represents pass and 1 represents fail

**Tip:** Use `CALCulate:CLIMits:FAIL?` to perform a composite (global) limit check.

**Suffix:**

<Chn> Channel number used to identify the active trace.

**Example:** See `CALCulate<Chn>:LIMit:CIRClE[:STATe]`

**Usage:** Query only

**Manual operation:** See "Limit Check" on page 206

**CALCulate:LIMit:CIRClE:FAIL:ALL?** [<RecallSet>]

Returns a 0 or 1 to indicate whether or not the circle limit check has failed for at least one channel in the referenced recall set. 0 represents pass and 1 represents fail

**Query parameters:**

<RecallSet> Recall set name; if omitted the active recall set is used

**Usage:** Query only

**Manual operation:** See "[Limit Check](#)" on page 206

**CALCulate<Chn>:LIMit:CIRClE:SOUNd[:STATe]** <Boolean>

Switches the acoustic signal (fail beep) on or off. The fail beep is generated each time the analyzer detects an exceeded circle limit.

**Suffix:**

<Chn> Channel number used to identify the active trace.

**Parameters:**

<Boolean> ON | OFF - Fail beep on or off.

\*RST: OFF

**Example:** CALCulate:LIMit:CIRClE:STATe ON; SOUNd ON  
Switch the limit check on and activate the fail beep.

**Manual operation:** See "[Limit Fail Beep](#)" on page 208

**CALCulate<Chn>:LIMit:CIRClE[:STATe]** <Boolean>

Switches the circle limit check on or off.

**Suffix:**

<Chn> Channel number used to identify the active trace.

**Parameters:**

<Boolean>

**Example:** \*RST; CALCulate:LIMit:CIRClE:DATA 0, 0, 0.5  
Define a circle limit line centered around the origin of the polar diagram, assigning a radius of 0.5 U.  
CALCulate:LIMit:CIRClE:STATe ON; FAIL?  
Switch the limit check on and query the result.

**Manual operation:** See "[Limit Check](#)" on page 206

**CALCulate<Chn>:LIMit:CIRClE:CLEar**

Resets the circle test for the active trace of channel <Chn>.

**Suffix:**

<Chn> Channel number

**Usage:** Event

**Manual operation:** See "Clear Test" on page 208

---

**CALCulate<Chn>:LIMit:CONTRol[:DATA]** <FreqPowTime>, <FreqPowTime>...

Defines the stimulus values of the limit line and/or creates new limit line segments. See also [Chapter 3.4.1.1, "Rules for Limit Line Definition"](#), on page 64.

#### Rules for creating segments

The following rules apply to an active trace with n existing limit line segments:

- An odd number of values is rejected; an error message -109,"Missing parameter..." is generated.
- An even number of 2\*k values updates or generates k limit line segments.
- For n > k the stimulus values of all existing limit line segments no. 1 to k are updated, the existing limit line segments no. k+1, ..., n are deleted.
- For n < k the stimulus values of the limit line segments no. 1 to n are updated, the limit line segments n+1, ..., k are generated with default response values (see [CALCulate<Chn>:LIMit:UPPer\[:DATA\]](#), [CALCulate<Chn>:LIMit:LOWer\[:DATA\]](#)).

**Note:** The generated segments are upper or lower limit line segments, depending on the [CALCulate<Chn>:LIMit:SEGment<Seg>:TYPE](#) setting.

[CALCulate<Ch>:LIMit:CONTRol\[:DATA\]](#) does not overwrite the type setting.

**Tip:** To define additional new limit line segments without overwriting the old segments use [CALCulate<Chn>:LIMit:DATA](#).

#### Suffix:

<Chn> Channel number used to identify the active trace.

#### Parameters:

<FreqPowTime> Default unit: NN

<FreqPowTime> Pair(s) of frequency, power or time values, to be defined in accordance with the sweep type ([\[SENSE<Ch>:\]SWEep:TYPE](#)). See also [Chapter 3.4.1.1, "Rules for Limit Line Definition"](#), on page 64.

Range: Virtually no restriction for limit segments.

\*RST: A segment that is created implicitly, e.g. by means of [CALCulate<Ch>:LIMit:UPPer\[:DATA\]](#) or [CALCulate<Ch>:LIMit:LOWer\[:DATA,\]](#), covers the maximum sweep range of the analyzer.

Default unit: NN

#### Example:

```
*RST; :CALC:LIM:CONT 1 GHz, 2 GHz
```

Select a lin. frequency sweep (default) and define an upper limit line segment in the stimulus range between 1 GHz and 2 GHz, using default response values (–40 dB).

```
CALC:LIM:DISP ON
```

Show the limit line segment in the active diagram.

**Manual operation:** See "Segment List" on page 199

**CALCulate<Chn>:LIMit:CONTRol:SHIFt <LimShift>**

Shifts an existing existing limit line in horizontal direction. See also [Chapter 3.4.1.1, "Rules for Limit Line Definition"](#), on page 64.

**Suffix:**

<Chn> Channel number used to identify the active trace.

**Setting parameters:**

<LimShift> Offset value for the limit line  
 Range: Virtually no restriction for limit segments  
 Default unit: NN

**Example:**

```
*RST; :CALC:LIM:CONT 1 GHZ, 2 GHZ
Define a limit line segment in the stimulus range between 1 GHz
and 2 GHz, using default response values.
CALC:LIM:CONT:SHIF 1; :CALC:LIM:CONT?
Shift the segment by 1 Hz. The modified limit line segment
ranges from 1000000001 (Hz) to 2000000001 (Hz).
```

**Usage:** Setting only

**Manual operation:** See ["Shift Lines"](#) on page 198

**CALCulate<Chn>:LIMit:DATA <Type>, <StartStim>, <StopStim>, <StartResp>, <StopResp>**

Defines the limit line type, the stimulus and response values for a limit line with an arbitrary number of limit line segments. See [Chapter 3.4.1.1, "Rules for Limit Line Definition"](#), on page 64.

**Note:** In contrast to `CALCulate<Chn>:LIMit:CONTRol[:DATA]`, this command does not overwrite existing limit line segments. The defined segments are appended to the segment list as new segments.

**Suffix:**

<Chn> Channel number used to identify the active trace.

**Parameters:**

<Type> Identifier for the type of the limit line segment:  
 0 – limit line segment off, segment defined but no limit check performed.  
 1 – upper limit line segment  
 2 – lower limit line segment  
 Range: 0, 1, 2 (see above)



<StartStim>,  
<StopStim>,  
<StartResp>,  
<StopResp>

Stimulus and response values of the first and last points of the limit line segment.

Range: Virtually no restriction for limit segments  
Default unit: The default stimulus units depend on the sweep type: Hz for frequency sweeps, dBm for power sweeps, s for time sweeps. The default response units are the units of the selected trace format (CALCulate<Chn>:FORMat).

**Example:**

```
*RST; :CALC:LIM:CONT 1 GHZ, 1.5 GHZ
Define an upper limit line segment in the stimulus range
between 1 GHz and 1.5 GHz, using default response values.
CALC:LIM:DATA 1, 1500000000, 2000000000, 2, 3
Define an upper limit line segment in the stimulus range
between 1.5 GHz and 2 GHz, assigning response values of +2
dB and +3 dB.
CALC:LIM:DISP ON
Show the limit line segment in the active diagram.
```

**Manual operation:** See "[Segment List](#)" on page 199

#### CALCulate<Chn>:LIMit:DCIRcle:CLEar

Resets the display circle to its default configuration (unit circle; show border: off; limit to circle: off).

**Suffix:**  
<Chn> Channel number  
The reset applies to the active trace of channel <Chn>.

**Usage:** Event

**Manual operation:** See "[Clear Circle](#)" on page 209

#### CALCulate<Chn>:LIMit:DCIRcle:DATA <CenterX>, <CenterY>, <Radius>

Defines the display circle for the active trace of channel <Chn>.

**Suffix:**  
<Chn> Channel number

**Parameters:**  
<CenterX> X position (real part) of the display circle's center  
<CenterY> Y position (imaginary part) of the display circle's center  
<Radius> Radius of the display circle

**Manual operation:** See "[Draw Circle | Radius, Center X, Center Y](#)" on page 209

#### CALCulate<Chn>:LIMit:DCIRcle:DISPlay[:STATe] <Boolean>

Sets/queries the visibility of the display circle for the active trace of channel <Chn>.

The display circle is defined using `CALCulate<Chn>:LIMit:DCIRcle:DATA`.

**Suffix:**

<Chn> Channel number

**Parameters:**

<Boolean> If set to ON, the line of the display circle is shown whenever the related trace is displayed in complex format.

**Manual operation:** See "[Show Border](#)" on page 209

**CALCulate<Chn>:LIMit:DCIRcle[:STATe] <Boolean>**

Sets/queries the state of the display circle for the active trace of channel <Chn>.

The display circle is defined using `CALCulate<Chn>:LIMit:DCIRcle:DATA`.

**Suffix:**

<Chn> Channel number

**Parameters:**

<Boolean> If set to ON, only trace points within the display circle are shown at the GUI whenever the related trace is displayed in complex format.

**Manual operation:** See "[Limit to Circle On/Off](#)" on page 209

**CALCulate<Chn>:LIMit:DELeTe:ALL**

Deletes all limit line segments.

**Suffix:**

<Chn> Channel number used to identify the active trace.

**Example:**

```
*RST; :CALC:LIM:CONT 1 GHz, 1.5 GHz
Define an upper limit line segment in the stimulus range
between 1 GHz and 1.5 GHz, using default response values.
CALC:LIM:DATA 1,1500000000, 2000000000,2,3
Define an upper limit line segment in the stimulus range
between 1.5 GHz and 2 GHz, assigning response values of +2
dB and +3 dB.
CALC:LIM:DEL:ALL
Delete both created limit line segments.
```

**Usage:** Event

**Manual operation:** See "[Add / Insert / Delete / Delete All](#)" on page 200

**CALCulate<Chn>:LIMit:DISPlay[:STATe] <Boolean>**

Displays or hides the entire limit line (including all segments) associated to the active trace.

**Suffix:**  
 <Chn> Channel number used to identify the active trace.

**Parameters:**  
 <Boolean> ON | OFF - Limit line on or off.  
 \*RST: OFF

**Example:**  
 \*RST; :CALC:LIM:CONT 1 GHZ, 2 GHZ  
 Define an upper limit line segment in the stimulus range between 1 GHz and 2 GHz, using default response values.  
 CALC:LIM:DISP ON  
 Show the limit line segment in the active diagram.

**Manual operation:** See "[Show Limit Line](#)" on page 195

**CALCulate<Chn>:LIMit:FAIL?**

Returns a 0 or 1 to indicate whether or not the limit check has failed. 0 represents pass and 1 represents fail

**Tip:** Use `CALCulate:CLIMits:FAIL?` to perform a composite (global) limit check.

Since V2.20 of the R&S ZNC/ZND FW the result is automatically recalculated whenever a relevant setting is changed, i.e. a subsequent query will return the updated limit violation state.

**Suffix:**  
 <Chn> Channel number used to identify the active trace.

**Example:**  
 \*RST; :CALC:LIM:CONT 1 GHZ, 2 GHZ  
 Define an upper limit line segment in the stimulus range between 1 GHz and 2 GHz, using default response values.  
 CALC:LIM:STAT ON; FAIL?  
 Switch the limit check on and query the result.  
 CALC:LIM:STAT:AREA LEFT, TOP  
 For a subsequent check at the GUI or a hardcopy, move the pass/fail message to the top left position.

**Usage:** Query only

**Manual operation:** See "[Limit Check](#)" on page 196

**CALCulate:LIMit:FAIL:ALL? [<RecallSet>]**

Returns a 0 or 1 to indicate whether or not the limit line check has failed for at least one channel in the referenced recall set. 0 represents pass and 1 represents fail.

**Query parameters:**  
 <RecallSet> Recall set name; if omitted the active recall set is used

**Usage:** Query only

**Manual operation:** See "[Limit Check](#)" on page 196

**CALCulate<Chn>:LIMit:SEGMent<Seg>:AMPLitude:STARt <Response>**  
**CALCulate<Chn>:LIMit:SEGMent<Seg>:AMPLitude:STOP <Response>**

These commands change the start or the stop response values (i.e. the response values assigned to the start or stop stimulus values) of a limit line segment. A segment must be created first to enable the commands (e.g. `CALCulate<Chn>:LIMit:DATA`). See also [Chapter 3.4.1.1, "Rules for Limit Line Definition"](#), on page 64.

**Tip:** To define the response values of several limit line segments with a single command, use `CALCulate<Chn>:LIMit:LOWer[:DATA]` or `CALCulate<Chn>:LIMit:UPPer[:DATA]`.

**Suffix:**

<Chn> Channel number used to identify the active trace.  
 <Seg> Segment number

**Parameters:**

<Response> Response value  
 Range: Virtually no restriction for limit segments  
 \*RST: The default response values of a segment that is created by defining its stimulus values only (e.g. by means of `CALCulate<Ch>:LIMit:CONTRol[:DATA]`), are -40 dB.  
 Default unit: NN

**Example:**

```
CALC:LIM:DATA 1,1500000000, 2000000000,2,3
Define an upper limit line segment (segment no. 1) in the stimulus range between 1.5 GHz and 2 GHz, assigning response values of +2 dB and +3 dB.
:CALC:LIM:SEGM:AMPL:STAR 5; STOP 5; :CALC:LIM:SEGM:TYPE LMIN
Change the segment to a lower limit line segment with a constant response value of +5 dB.
CALC:LIM:DATA?
Query the type, the stimulus and response values of the created segment with a single command. The response is
2,1500000000,2000000000,5,5.
```

**Manual operation:** See "[Segment List](#)" on page 199

**CALCulate<Chn>:LIMit:SEGMent:COUNT?**

Returns the number of limit line segments, including enabled and disabled segments.

**Suffix:**

<Chn> Channel number used to identify the active trace.

- Example:** `CALC:LIM:DATA 1,1500000000, 2000000000,2,3`  
 Define an upper limit line segment (segment no. 1) in the stimulus range between 1.5 GHz and 2 GHz, assigning response values of +2 dB and +3 dB.  
`CALC:LIM:SEGM:COUNT?`  
 Query the number of segments. The response is 1.
- Usage:** Query only
- Manual operation:** See "[Segment List](#)" on page 199

**CALCulate<Chn>:LIMit:SEGMent<Seg>:STIMulus:START <FreqPowTime>**  
**CALCulate<Chn>:LIMit:SEGMent<Seg>:STIMulus:STOP <FreqPowTime>**

These commands change the start and stop stimulus values (i.e. the smallest and the largest stimulus values) of a limit line segment. A segment must be created first to enable the commands (e.g. `CALCulate<Chn>:LIMit:DATA`). See also [Chapter 3.4.1.1, "Rules for Limit Line Definition"](#), on page 64.

**Tip:** To define the stimulus values of several limit line segments with a single command, use `CALCulate<Chn>:LIMit:CONTRol[:DATA]`.

**Suffix:**

- <Chn> Channel number used to identify the active trace.  
 <Seg> Segment number

**Parameters:**

- <FreqPowTime> Frequency, power or time value, to be defined in accordance with the sweep type (`[SENSE<Ch>:]SWEep:TYPE`).
- Range: Virtually no restriction for limit segments.  
 \*RST: A segment that is created implicitly, e.g. by means of `CALCulate<Ch>:LIMit:UPPer[:DATA]` or `CALCulate<Ch>:LIMit:LOWer[:DATA,]`, covers the maximum sweep range of the analyzer.
- Default unit: Hz for frequency sweeps, dBm for power sweeps, s for time sweeps

- Example:** `CALC:LIM:DATA 1,1500000000, 2000000000,2,3`  
 Define an upper limit line segment (segment no. 1) in the stimulus range between 1.5 GHz and 2 GHz, assigning response values of +2 dB and +3 dB.  
`CALC:LIM:SEGM:STIM:STAR 1GHZ; STOP 2 GHZ; :`  
`CALC:LIM:SEGM:TYPE LMIN`  
 Change the segment to a lower limit line segment with a stimulus range between 1 GHz and 2 GHz.  
`CALC:LIM:DATA?`  
 Query the type, the stimulus and response values of the created segment with a single command. The response is `2,1000000000,2000000000,2,3`.
- Manual operation:** See "[Segment List](#)" on page 199

**CALCulate<Chn>:LIMit:SEGMent<Seg>:TYPE <LimLineType>**

Selects the limit line type for a limit line segment. This can be done before or after defining the stimulus and response values of the segment, however, a segment must be created first to enable this command (e.g `CALC:LIM:DATA`).

**Note:** The type command overwrites the `CALCulate<Chn>:LIMit:DATA` settings and is overwritten by them. It is not affected by the other commands in the `CALCulate<Chn>:LIMit...` subsystem defining stimulus and response values of limit lines.

**Suffix:**

<Chn> Channel number used to identify the active trace.  
 <Seg> Segment number

**Parameters:**

<LimLineType> LMIN | LMAX | OFF  
 Limit line type  
 Range: LMAX (upper limit line segment), LMIN (lower limit line segment), OFF (limit check switched off, limit line segment not deleted)  
 \*RST: LMAX

**Example:**

```
*RST; :CALC:LIM:UPP 0, 0
Define an upper limit line segment across the entire sweep
range, using a constant upper limit of 0 dBm.
CALC:LIM:SEGM:TYPE LMIN
Turn the defined limit line segment into a lower limit line segment.
```

**Manual operation:** See "[Segment List](#)" on page 199

**CALCulate<Chn>:LIMit:SOUNd[:STATe] <Boolean>**

Switches the acoustic signal (fail beep) on or off. The fail beep is generated each time the analyzer detects an exceeded limit.

**Suffix:**

<Chn> Channel number used to identify the active trace.

**Parameters:**

<Boolean> ON | OFF - Fail beep on or off.  
 \*RST: OFF

**Example:**

```
CALC:LIM:STAT ON; SOUN ON
Switch the limit check on and activate the fail beep.
```

**Manual operation:** See "[Limit Fail Beep](#)" on page 197

**CALCulate<Chn>:LIMit:STATe <Boolean>**

Switches the limit check (including upper and lower limits) on or off.

**Tip:** Use `CALCulate<Ch>:LIMit:UPPer:STATe` or `CALCulate<Ch>:LIMit:LOWer:STATe` to switch on or off the individual limit checks for upper or lower limit lines.

**Suffix:**

<Chn> Channel number used to identify the active trace.

**Parameters:**

<Boolean> ON | OFF - Limit check on or off.

\*RST: OFF

**Example:**

```
*RST; CALC:LIM:CONT 1 GHZ, 2 GHZ
```

Define an upper limit line segment in the stimulus range between 1 GHz and 2 GHz, using default response values.

```
CALC:LIM:STAT ON; FAIL?
```

Switch the limit check on and query the result.

**Manual operation:** See "[Limit Check](#)" on page 196

**CALCulate<Chn>:LIMit:STATe:AREA** <HorizontalPos>, <VerticalPos>

Moves the limit check pass/fail message for the active trace <Chn> to one of nine pre-defined positions in the active diagram.

**Suffix:**

<Chn> Channel number used to identify the active trace.

**Parameters:**

<HorizontalPos> LEFT | MID | RIGHT

Horizontal position

<VerticalPos> TOP | MID | BOTTOm

Vertical position

**Example:**

See `CALCulate<Chn>:LIMit:FAIL?`

**Manual operation:** See "[Limit Check](#)" on page 196

**CALCulate<Chn>:LIMit:TTLout<Pt>[:STATe]** <Boolean>

Switches the TTL pass/fail signals on or off. The signals are applied to the USER PORT connector as long as the active trace <Chn> is within limits, including the ripple limits.

**Suffix:**

<Chn> Channel number used to identify the active trace.

<Pt>

1 - TTL out pass 1 (pin 13 of USER PORT connector)

2 - TTL out pass 2 (pin 14 of USER PORT connector)

**Parameters:**

<Boolean> ON | OFF - TTL output signal on or off.

\*RST: OFF

**Example:**                    \*RST; :CALC:LIM:CONT 1 GHZ, 2 GHZ  
                                  Define an upper limit line segment in the stimulus range  
                                  between 1 GHz and 2 GHz, using default response values.  
                                  CALC:LIM:STAT ON; TTL2 ON  
                                  Switch the limit check on and activate the TTL out pass 2 signal.

**Manual operation:**    See "TTL 1 / 2 Pass" on page 198

**CALCulate<Chn>:LIMit:LOWer[:DATA]** <ResponseValue>, <ResponseValue>...

**CALCulate<Chn>:LIMit:UPPer[:DATA]** <StartResponse>,  
                                  <StopResponse>[,<StartResponse>, <StopResponse>[,...]]

Sets/gets the response (y-axis) values of the lower/upper limit lines and/or creates new limit line segments. See also [Chapter 3.4.1.1, "Rules for Limit Line Definition"](#), on page 64.

**Note** that in contrast to commands addressing a single limit line segment <Seg> (such as [CALCulate<Chn>:LIMit:SEGment<Seg>:TYPE](#)), these commands **assume** that

- lower limit line segments are assigned even numbers (<Seg> = 2, 4, 6, ... ) and
- upper limit line segments are assigned odd numbers (<Seg> = 1, 3, 5, ...).

[CALCulate<Chn>:LIMit:LOWer/UPPer](#) sets the type and response values of even/odd limit line segments and gets the response values of even/odd limit line segments - no matter what the current type of these segments actually is!

Both commands will only work, if the total number of limit line segments is even.

#### Rules for creating and updating segments

Suppose that the active trace is equipped with 2s limit line segments (of any type) and k pairs of response values are passed with the command.

- [CALCulate:LIMit:LOWer](#)
  - deletes "obsolete" limit line segments 2k+1, ..., 2s
  - updates even limit line segments 2, 4, ..., 2s with type=lower and the given response values
  - creates lower limit line segments 2s+2, 2s+4, ..., 2k with (type=lower and) the given response values
  - creates "missing" upper limit line segments 2s+1, 2s+3, ..., 2k-1 with (type=upper and) default response values
- [CALCulate:LIMit:UPPer](#)
  - deletes "obsolete" limit line segments 2k+1, ..., 2s
  - updates odd limit line segments 1, 3, ..., 2s-1 with type=upper and the given response values
  - creates upper limit line segments 2s+1, 2s+3, ..., 2k-1 with (type=upper and) the given response values
  - creates "missing" lower limit line segments 2s+2, 2s+4, ..., 2k with (type=lower and) default response values



If  $s > 0$ , newly created lower/upper limit line segments inherit their start and stop stimuli from the limit line segment with the highest even/odd number. Otherwise their stimulus range is set to the entire sweep range.

See `CALCulate<Chn>:LIMit:CONTRol[:DATA]` on how to change the stimulus values of a limit line segment.

**Suffix:**

<Chn> Channel number used to identify the active trace.

**Parameters:**

<StartResponse>, <StopResponse>, ... Pair(s) of response values. In the parameter list, item  $2s-1$  defines the "Start Response" and item  $2s$  defines the "Stop Response" of upper/lower limit line segment  $s = 1, 2, \dots$ . An odd number of values is rejected with an error message `-109,"Missing parameter..."`.

Range: Virtually no restriction for limit segments.

\*RST: Implicitly created segments are created with a default response value of `-40dB`.

Default unit: dB

**Example:**

```
CALC:LIM:LOW -10, 0, 0, -10
```

Define two limit line segments covering the entire sweep range. Two upper limit line segments with default response values are created in addition.

```
CALC:LIM:UPP 0, 10, 10, 0
```

Change the response values of the upper limit line segments .

```
CALC:LIM:DISP ON
```

Show the limit line segments in the active diagram.

**Manual operation:** See "[Segment List](#)" on page 199

```
CALCulate<Chn>:LIMit:LOWer:FEED <StimulusOffset>, <ResponseOffset>[, <TraceName>]
```

```
CALCulate<Chn>:LIMit:UPPer:FEED <StimulusOffset>, <ResponseOffset>[, <TraceName>]
```

Generates a lower or an upper limit line using the stimulus values of a data or memory trace and specified offset values.

**Suffix:**

<Chn> Channel number used to identify the active trace. This trace provides the stimulus data for the limit line unless another trace <TraceName> is specified.

**Setting parameters:**

<StimulusOffset> Stimulus offset value, used to shift all imported limit line segments in horizontal direction.

Default unit: NN

<ResponseOffset> Response offset value, used to shift all imported limit line segments in vertical direction.

Default unit: dB

<TraceName> Name of the selected trace as used e.g. in `CALCulate<Ch>:PARAmeter:SDEFine`. If no trace name is specified the analyzer uses the active trace no. <Chn>.

**Example:**

```
CALC:LIM:LOW:FEED 1 GHZ, -10
```

Use the stimulus values of the active trace, shifted by 1 GHz to the right and decreased by -10 dB, to create a lower limit line.

```
CALC:LIM:UPP:FEED 1 GHZ, 10
```

Use the stimulus values of the active trace, shifted by 1 GHz to the right and increased by 10 dB, to create an upper limit line.

```
CALC:LIM:LOW:SHIF -3; :CALC:LIM:CONT:SHIF 1 GHZ
```

Shift the lower limit line by an additional -3 dB in vertical and by 1 GHz in horizontal direction. The upper limit line is also shifted.

**Usage:** Setting only

**Manual operation:** See "[Segment List](#)" on page 199

**CALCulate<Chn>:LIMit:LOWer:SHIFt <LimShift>**

**CALCulate<Chn>:LIMit:UPPer:SHIFt <LimShift>**

These commands shift all lower and upper limit line segments assigned to the active trace in vertical direction. Both commands shift **all** limit lines; they have the same functionality. See also [Chapter 3.4.1.1, "Rules for Limit Line Definition"](#), on page 64.

**Suffix:**

<Chn> Channel number used to identify the active trace.

**Setting parameters:**

<LimShift> Response offset value for all limit line segments.

Range: Virtually no restriction for limit segments

Default unit: NN

**Example:** See `CALCulate<Chn>:LIMit:LOWer:FEED`

**Usage:** Setting only

**Manual operation:** See "[Shift Lines](#)" on page 198

**CALCulate<Chn>:LIMit:CLEAr**

Resets the limit check results for the limit line test.

**Suffix:**

<Chn> Channel number

**Usage:** Event

**Manual operation:** See "[Clear Test](#)" on page 197

### 6.3.2.8 CALCulate:MARKer...

The `CALCulate:MARKer...` commands control the marker functions. The commands are device-specific and beyond what is specified in the SCPI subsystem `SOURCE:MARKer...`

<code>CALCulate&lt;Chn&gt;:MARKer&lt;Mk&gt;:AOFF</code> .....	435
<code>CALCulate&lt;Chn&gt;:MARKer&lt;Mk&gt;:BWIDth</code> .....	436
<code>CALCulate&lt;Chn&gt;:MARKer&lt;Mk&gt;:COUPled[:STATe]</code> .....	437
<code>CALCulate&lt;Chn&gt;:MARKer:DEFault:FORMat</code> .....	438
<code>CALCulate&lt;Chn&gt;:MARKer&lt;Mk&gt;:DELTA[:STATe]</code> .....	439
<code>CALCulate&lt;Chn&gt;:MARKer&lt;Mk&gt;:FORMat</code> .....	439
<code>CALCulate:MARKer:FUNction:BWIDth:GMCenter</code> .....	440
<code>CALCulate&lt;Chn&gt;:MARKer&lt;Mk&gt;:FUNction:BWIDth:MODE</code> .....	440
<code>CALCulate&lt;Chn&gt;:MARKer&lt;Mk&gt;:FUNction:CENter</code> .....	441
<code>CALCulate&lt;Chn&gt;:MARKer&lt;Mk&gt;:FUNction:DOMain:USER[:RANGe]</code> .....	441
<code>CALCulate&lt;Chn&gt;:MARKer&lt;Mk&gt;:FUNction:DOMain:USER:SHOW</code> .....	442
<code>CALCulate&lt;Chn&gt;:MARKer&lt;Mk&gt;:FUNction:DOMain:USER:START</code> .....	442
<code>CALCulate&lt;Chn&gt;:MARKer&lt;Mk&gt;:FUNction:DOMain:USER:STOP</code> .....	442
<code>CALCulate&lt;Chn&gt;:MARKer&lt;Mk&gt;:FUNction:EXEcute</code> .....	443
<code>CALCulate&lt;Chn&gt;:MARKer&lt;Mk&gt;:FUNction:RESult?</code> .....	444
<code>CALCulate&lt;Chn&gt;:MARKer&lt;Mk&gt;:FUNction:SPAN</code> .....	444
<code>CALCulate&lt;Chn&gt;:MARKer&lt;Mk&gt;:FUNction:START</code> .....	445
<code>CALCulate&lt;Chn&gt;:MARKer&lt;Mk&gt;:FUNction:STOP</code> .....	445
<code>CALCulate&lt;Chn&gt;:MARKer&lt;Mk&gt;:MODE</code> .....	445
<code>CALCulate&lt;Chn&gt;:MARKer&lt;Mk&gt;:NAME</code> .....	446
<code>CALCulate&lt;Chn&gt;:MARKer&lt;Mk&gt;:REFerence:MODE</code> .....	446
<code>CALCulate&lt;Chn&gt;:MARKer&lt;Mk&gt;:REFerence:NAME</code> .....	447
<code>CALCulate&lt;Chn&gt;:MARKer&lt;Mk&gt;:REFerence[:STATe]</code> .....	447
<code>CALCulate&lt;Chn&gt;:MARKer&lt;Mk&gt;:REFerence:TYPE</code> .....	447
<code>CALCulate&lt;Chn&gt;:MARKer&lt;Mk&gt;:REFerence:X</code> .....	448
<code>CALCulate&lt;Chn&gt;:MARKer&lt;Mk&gt;:REFerence:Y?</code> .....	449
<code>CALCulate&lt;Chn&gt;:MARKer:SEARch:BFILter:RESult[:STATe]</code> .....	449
<code>CALCulate&lt;Chn&gt;:MARKer:SEARch:BFILter:RESult[:STATe]:AREA</code> .....	449
<code>CALCulate&lt;Chn&gt;:MARKer&lt;Mk&gt;:SEARch:TRACking</code> .....	450
<code>CALCulate&lt;Chn&gt;:MARKer&lt;Mk&gt;:SEARch:FORMat</code> .....	450
<code>CALCulate&lt;Chn&gt;:MARKer&lt;Mk&gt;[:STATe]</code> .....	451
<code>CALCulate&lt;Chn&gt;:MARKer[:STATe]:AREA</code> .....	452
<code>CALCulate&lt;Chn&gt;:MARKer&lt;Mk&gt;:TARGet</code> .....	452
<code>CALCulate&lt;Chn&gt;:MARKer&lt;Mk&gt;:TYPE</code> .....	453
<code>CALCulate&lt;Chn&gt;:MARKer&lt;Mk&gt;:X</code> .....	453
<code>CALCulate&lt;Chn&gt;:MARKer&lt;Mk&gt;:Y?</code> .....	454

---

#### **CALCulate<Chn>:MARKer<Mk>:AOFF**

Removes all markers from all traces of the active recall set. The removed markers remember their properties (stimulus value, format, delta mode, number) when they are restored (`CALCulate<Chn>:MARKer<Mk>[:STATe] ON`). The marker properties are definitely lost if the associated trace is deleted.

<b>Suffix:</b>	
<Chn>	Channel number used to identify the active trace. If unspecified the numeric suffix is set to 1.
<Mk>	Marker number in the range 1 to 10. This numeric suffix is ignored and may be set to any value.
<b>Example:</b>	Suppose that the active recall set contains an active trace no. 1. <code>CALC:MARK1 ON; MARK2 ON</code> Create markers 1 and 2 and assign them to the trace no. 1. <code>CALC:MARK:AOFF</code> Remove both markers.
<b>Usage:</b>	Event
<b>Manual operation:</b>	See " <a href="#">All Markers Off</a> " on page 212

---

### **CALCulate<Chn>:MARKer<Mk>:BWIDth <Bandwidth>**

Sets the bandfilter level for a bandfilter search or returns the results. The command is only available after a bandfilter search has been executed (`CALCulate<Chn>:MARKer<Mk>:FUNCTION:EXECuteBFILter`; see example below).

The response to the query `CALCulate<Chn>:MARKer<Mk>:BWIDth?` contains the following bandfilter search results:

- <Bandwidth> – bandwidth of the bandpass/bandstop region.
- <Center> – stimulus frequency at the center of the bandpass/bandstop region (the stimulus value of marker M4).
- <QualityFactor (3 dB)> – quality factor, i.e. the ratio between the center frequency and the 3-dB bandwidth.
- <Loss> – loss at the center of the bandpass/bandstop region (the response value of marker M4 at the time of the bandfilter search).
- <LowerEdge> – lower band edge.
- <UpperEdge> – upper band edge.

**Tip:** To obtain the <Quality Factor (BW)> result from the bandfilter info field, calculate the ratio <Center> / <Bandwidth>.

<b>Suffix:</b>	
<Chn>	Channel number used to identify the active trace.
<Mk>	Marker number in the range 1 to 10. This numeric suffix is ignored and may be set to any value because the bandfilter search functions always use markers M1 to M4.

**Parameters:**

&lt;Bandwidth&gt;

Difference between the band edges and the center response value of a bandfilter peak; must be negative for a bandpass search and positive for a bandstop search.

Range: For bandpass: -100.00 dB to -0.01 dB; for bandstop: +0.01 dB to +100.00 dB

Increment: 0.03 dB

\*RST: -3 dB

Default unit: dB

**Example:**

```
CALC:MARK:FUNC:BWID:MODE BST
```

Select a bandstop filter search.

```
CALC:MARK:FUNC:EXEC BFIL
```

Initiate the bandpass filter search for the current trace. Create markers M1 to M4.

```
CALC:MARK:SEAR:BFIL:RES ON
```

Display the marker info field in the diaram area.

```
CALC:MARK:BWID 6
```

Select a 6-dB bandwidth for the bandstop.

```
CALC:MARK:BWID?
```

Query the results of the bandfilter search. An error message is generated if the bandfilter search fails so that no valid results are available.

```
CALC:MARK:SEAR:BFIL:RES:AREA LEFT, TOP
```

For a subsequent check at the GUI or a hardcopy, move the info field to the top left position.

**Manual operation:** See ["Result Off"](#) on page 225

**CALCulate<Chn>:MARKer<Mk>:COUPled[:STATe] <Boolean>**

Couples the markers of all traces in the active recall set to the markers of trace no. <Chn>, provided that they have the same sweep type (`[SENSe<Ch>:]SWEep:TYPE`).

**Suffix:**

&lt;Chn&gt;

Channel number used to identify the active trace. The effects of marker coupling depend on the active trace number; see ["Marker Coupling"](#) on page 32.

&lt;Mk&gt;

Marker number in the range 1 to 10. This suffix is ignored because the command affects all markers.

**Parameters:**

&lt;Boolean&gt;

ON | OFF - enables or disables marker coupling.

\*RST: OFF

**Example:** Suppose that the active recall set contains two traces Trc1 and Trc2, assigned to channels no. 1 and 2, respectively.

```
:CALC1:PAR:SEL 'TRC1'; :CALC1:MARK1 ON; MARK2 ON
```

Select Trc1 as the active trace and create the two markers no. 1 and 2. The default position for both markers is the center of the sweep range.

```
CALC1:MARK:COUP ON
```

Create two markers no. 1 and 2 on Trc 2 and couple them to the markers of Trc 1.

**Manual operation:** See "[Coupled Markers](#)" on page 212

---

### CALCulate<Chn>:MARKer:DEFault:FORMat <OutFormat>

Defines the default marker format of the selected channel's active trace.

New markers will be formatted with the default marker format; previously existing markers will be reformatted if (and only if) their marker format is set to (Trace) DEFault (using `CALCulate<Chn>:MARKer<Mk>:FORMat`).

**Suffix:**

<Chn> Channel number used to identify the active trace

**Parameters:**

<OutFormat> DEFault | MLINear | MLOGarithmic | MDB | PHASe | POLar | COMPLex | GDElay | REAL | IMAGinary | SWR | LINPhase | MLPHase | LOGPhase | MDPHase | IMPedance | ADMittance | MIMPedance

DEFault means the default marker format is dynamically adjusted to the selected trace format (`CALCulate<Chn>:FORMat`).

For the other marker formats see the table below and the description in "[Marker Format](#)" on page 31.

\*RST: DEFault

**Manual operation:** See "[Default Marker Frmt](#)" on page 157

SCPI	GUI
MLINear	Lin Mag
MLOGarithmic MDB (for R&S ZVR compatibility)	dB Mag
PHASe	Phase
POLar COMPLex (for R&S ZVR compatibility)	Real Imag
GDElay	Delay
REAL	Real
IMAGinary	Imag

SCPI	GUI
SWR	SWR
LINPhase MLPhase (for R&S ZVR compatibility)	Lin Mag Phase
LOGPhase MDPhase (for R&S ZVR compatibility)	dB Mag Phase
IMPedance	$R + j X$
ADMittance	$G + j B$
MIMPedance	IMP Mag

---

**CALCulate<Chn>:MARKer<Mk>:DELTA[:STATe] <Boolean>**

Switches the delta mode for marker <Mk> on trace no. <Chn> on or off. The marker must be created before using `CALCulate<Chn>:MARKer<Mk> [:STATe] ON`. If the active trace contains no reference marker, the command also creates a reference marker.

**Suffix:**

<Chn> Channel number used to identify the active trace.

<Mk> Marker number in the range 1 to 10.

**Parameters:**

<Boolean> ON | OFF - Enables or disables the delta mode.

\*RST: OFF

**Example:**

Suppose that the active recall set contains an active trace no. 1.

```
CALC:MARK ON
```

Create marker no. 1 and set it to the center of the sweep range.

```
CALC:MARK:DELTA ON
```

Create a reference marker at the center of the sweep range and set marker 1 to delta mode.

**Manual operation:** See "[Mkr Stimulus / On / Delta Mode](#)" on page 211

---

**CALCulate<Chn>:MARKer<Mk>:FORMat <OutFormat>**

Sets/queries the output format for the (complex) value of the related marker.

**Suffix:**

<Chn> Channel number used to identify the active trace

<Mk> Marker number in the range 1 to 10.

**Parameters:**

<OutFormat> DEFault | MLINear | MLOGarithmic | MDB | PHASe | POLar | COMPlEx | GDELay | REAL | IMAGinary | SWR | LINPhase | MLPHase | LOGPhase | MDPHase | IMPedance | ADMittance | MIMPedance

**Note** that in contrast to previous releases DEFault now means the marker is formatted according the related trace's default marker format (see `CALCulate<Chn>:MARKer:DEFault:FORMat`), which may not be set to DEFault (= trace format). For the other marker formats see `CALCulate<Chn>:MARKer:DEFault:FORMat` and the description in "Marker Format" on page 31.

\*RST: DEFault

**Manual operation:** See "Marker Format" on page 213

**CALCulate:MARKer:FUNCTion:BWIDth:GMCenter <arg0>**

Defines how bandfilter searches calculate the center frequency of the passband or stopband.

**Parameters:**

<arg0> **ON** – use **geometric** mean of lower and upper band edge  
**OFF** – use **arithmetic** mean

\*RST: n/a (\*RST does not affect the calculation rule; the factory setting is ON/geometric mean)

**Manual operation:** See "Geometric Calculation of Bandfilter Center" on page 339

**CALCulate<Chn>:MARKer<Mk>:FUNCTion:BWIDth:MODE <BandfilterType>**

Selects the bandfilter search mode. In contrast to manual control, bandfilter tracking is not automatically activated.

**Suffix:**

<Chn> Channel number used to identify the active trace.

<Mk> Marker number in the range 1 to 10. This numeric suffix is ignored and may be set to any value because the bandfilter search functions always use markers M1 to M4.



**Parameters:**

<BandfilterType> BPASs | BStOp | BPRMarker | BSRMarker | BPABsolute | BSABsolute | NONE

Bandfilter search type:  
 BPASs – Bandpass Search Ref to Max  
 BStOp – Bandstop Search Ref to Max  
 BPRMarker – Bandpass Search Ref to Marker  
 BSRMarker – Bandstop Search Ref to Marker  
 BPABsolute – Bandpass Absolute Level  
 BSABsolute – Bandstop Absolute Level  
 NONE – deactivate bandfilter search, result off

\*RST: NONE

**Example:** See `CALCulate<Chn>:MARKer<Mk>:BWIDth`

**Manual operation:** See "[Bandpass Ref to Max](#)" on page 223

**CALCulate<Chn>:MARKer<Mk>:FUNctIon:CENTer**

Sets the center of the sweep range equal to the stimulus value of the marker <Mk> on trace no. <Chn>.

**Suffix:**

<Chn> Channel number used to identify the active trace.

<Mk> Marker number in the range 1 to 10.

**Example:**

```
*RST; :CALC:MARK ON
```

Create marker 1 in the center of the current sweep range and assign it to trace no. 1.

```
CALC:MARK:FUNC:CENT
```

Leave the sweep range unchanged.

**Usage:** Event

**Manual operation:** See "[Center = Marker](#)" on page 215

**CALCulate<Chn>:MARKer<Mk>:FUNctIon:DOMain:USER[:RANGe]  
<NumSearchRange>**

Assigns a search range no. <NumSearchRange> to marker no <Mk> and selects the search range, e.g. in order to display range limit lines or define the start and stop values.

**Suffix:**

<Chn> Channel number used to identify the active trace.

<Mk> Marker number in the range 1 to 10.

**Parameters:**

<NumSearchRange> Number of the search range.

Range: 0 to 10 where 0 refers to the fixed full span search range (equal to the sweep range) and 1 to 10 refer to user-definable search ranges; see example.

\*RST: 0 (reserved for full span search range)

**Example:**

```
CALC1:MARK1:FUNC:DOM:USER 2
```

Select the search range no. 2, assigned to marker no. 1 and trace no. 1.

```
CALC:MARK:FUNC:DOM:USER:START 1GHz
```

Set the start frequency of the search range to 1 GHz.

```
CALC:MARK:FUNC:DOM:USER:STOP 1.2GHz
```

Set the stop frequency of the search range to 1.2 GHz.

**Manual operation:** See ["Search Range"](#) on page 217

**CALCulate<Chn>:MARKer<Mk>:FUNCtion:DOMain:USER:SHOW <Boolean>**

Displays or hides range limit lines for the search range selected via [CALCulate<Chn>:MARKer<Mk>:FUNCtion:DOMain:USER\[:RANGE\]](#).

**Suffix:**

<Chn> Channel number used to identify the active trace.

<Mk> Marker number in the range 1 to 10.

**Parameters:**

<Boolean> ON | OFF - range limit lines on or off.

\*RST: OFF

**Example:** See [CALCulate<Chn>:STATistics:DOMain:USER](#)

**Manual operation:** See ["Range Limit Lines on"](#) on page 218

**CALCulate<Chn>:MARKer<Mk>:FUNCtion:DOMain:USER:START  
<StarSearchRange>**

**CALCulate<Chn>:MARKer<Mk>:FUNCtion:DOMain:USER:STOP  
<StopSearchRange>**

These commands define the start and stop values of the search range selected via [CALCulate<Chn>:MARKer<Mk>:FUNCtion:DOMain:USER\[:RANGE\]](#).

**Suffix:**

<Chn> Channel number used to identify the active trace.

<Mk> Marker number in the range 1 to 10.

**Parameters:**

<StopSearchRange> Beginning or end of the search range.

Range: Maximum allowed sweep range, depending on the instrument model and on the sweep type.

Default unit: NN

**Example:** See `CALCulate<Chn>:MARKer<Mk>:FUNction:DOMain:USER[:RANGE]`

**Manual operation:** See "Search Range" on page 217

---

### `CALCulate<Chn>:MARKer<Mk>:FUNction:EXECute [<SearchMode>]`

Selects a search mode for marker no. <Mk> and initiates the search. The marker must be created before using `CALCulate<Chn>:MARKer<Mk>[:STATe]ON` (exception: bandfilter search).

**Suffix:**

<Chn> Channel number used to identify the active trace.

<Mk> Marker number in the range 1 to 10. For a bandfilter search (`BFILter`) this numeric suffix is ignored and may be set to any value because the bandfilter search functions always use markers M1 to M4.

**Setting parameters:**

<SearchMode> MAXimum | MINimum | RPEak | LPEak | NPEak | TARGet | LTARGet | RTARGet | BFILter | MMAXimum | MMINimum  
See list of parameters below.

**Example:** Suppose that the active recall set contains an active trace no. 1.  
`CALC:MARK ON`  
Create marker M1 and assign it to trace no. 1.  
`CALC:MARK:FUNC:EXEC MAX; RES?`  
Move the created marker to the absolute maximum of the trace and query the stimulus and response value of the search result.

**Usage:** Setting only

**Manual operation:** See "Max / Min" on page 215

The analyzer provides the following search modes:

Mode	Find...
MAXimum	Absolute maximum in the search range (see <code>CALCulate&lt;Chn&gt;:MARKer&lt;Mk&gt;:FUNction:DOMain:USER[:RANGE]</code> )
MINimum	Absolute maximum in the search range
RPEak	Next valid peak to the right of the current marker position
LPEak	Next valid peak to the left
NPEak	Next highest or lowest value among the valid peaks (next peak)
TARGet	Target value (see <code>CALCulate&lt;Chn&gt;:MARKer&lt;Mk&gt;:TARGet</code> )
RTARGet	Next target value to the right of the current marker position
LTARGet	Next target value to the left

Mode	Find...
BFIltEr	Bandfilter search. The results are queried using <code>CALCulate&lt;Chn&gt;:MARKer&lt;Mk&gt;:BWIDth</code> .
MMAximum or MMINimum	Multiple peak search

---

### **CALCulate<Chn>:MARKer<Mk>:FUNction:RESult?**

Returns the result (stimulus and response value) of a search started by means of `CALCulate<Chn>:MARKer<Mk>:FUNction:EXECute`. The search must be executed before the command is enabled.

**Suffix:**

<Chn> Channel number used to identify the active trace.

<Mk> Marker number in the range 1 to 10. This numeric suffix is ignored and may be set to any value.

**Example:** See `CALCulate<Chn>:MARKer<Mk>:FUNction:EXECute`

**Usage:** Query only

**Manual operation:** See "Max / Min" on page 215

---

### **CALCulate<Chn>:MARKer<Mk>:FUNction:SPAN**

Sets the sweep span of the sweep range equal to the absolute value of the first coordinate of the active delta marker <Mk> on trace no. <Chn>.

**Suffix:**

<Chn> Channel number used to identify the active trace.

<Mk> Marker number in the range 1 to 10.

**Example:**

```
*RST; :CALC:MARK ON; MARK:DELTA ON
```

Create marker 1 in the center of the current sweep range and enable the delta mode.

```
CALC:MARK:X 300MHZ
```

Increase the stimulus value of the delta marker by 300 MHz.

```
CALC:MARK:FUNC:SPAN
```

Set the sweep range equal to 300 MHz. The sweep range starts at the reference marker position, i.e. in the center of the analyzer's frequency range.

**Usage:** Event

**Manual operation:** See "Center / Start / Stop / Span = Marker" on page 226

**CALCulate<Chn>:MARKer<Mk>:FUNCtion:START****CALCulate<Chn>:MARKer<Mk>:FUNCtion:STOP**

These command sets the beginning (. . .START) and the end (. . .STOP) of the sweep range equal to the stimulus value of the marker <Mk> on trace no. <Chn>.

**Suffix:**

<Chn> Channel number used to identify the active trace.

<Mk> Marker number in the range 1 to 10

**Example:**

```
*RST; :CALC:MARK ON
```

Create marker 1 in the center of the current sweep range and assign it to trace no. 1.

```
CALC:MARK:FUNC:STAR
```

Divide the sweep range in half, starting at the current marker position. As an alternative:

```
CALC:MARK:FUNC:STOP
```

Divide the sweep range in half, ending at the current marker position.

**Usage:** Event

**Manual operation:** See "[Center / Start / Stop / Span = Marker](#)" on page 226

**CALCulate<Chn>:MARKer<Mk>:MODE <Mode>**

Sets marker no. <Mk> to continuous or discrete mode. The marker doesn't have to be created before (`CALCulate<Chn>:MARKer<Mk>[:STATe]ON`), the mode can be assigned in advance.

**Suffix:**

<Chn> Channel number used to identify the active trace.

<Mk> Marker number in the range 1 to 10.

**Parameters:**

<Mode> CONTInuous | DISCcrete

CONTInuous - marker can be positioned on any point of the trace, and its response values are obtained by interpolation.

DISCcrete - marker can be set to discrete sweep points only.

```
*RST: CONT
```

**Example:**

Suppose that the active recall set contains an active trace no. 1.

```
CALC:MARK:MODE DISC; :CALC:MARK2:MODE CONT
```

Create marker 1 in discrete mode and marker 2 in continuous mode.

```
CALC:MARK ON; MARK2 ON
```

Display the two markers. Due to the different modes the horizontal positions can be different.

**Manual operation:** See "[Discrete](#)" on page 213

**CALCulate<Chn>:MARKer<Mk>:NAME <MarkerName>**

Defines a name for marker no. <Mk>. The marker doesn't have to be created before (CALCulate<Chn>:MARKer<Mk>[:STATe]ON), the name can be assigned in advance.

**Suffix:**

<Chn> Channel number used to identify the active trace.  
 <Mk> Marker number in the range 1 to 10.

**Parameters:**

<MarkerName> Marker name (string parameter)  
 \*RST: 'M1' for marker no. 1 etc.

**Example:**

Suppose that the active recall set contains an active trace no. 1.  
 CALC:MARK:NAME '&\$% 1'; :CALC:MARK ON  
 Create marker 1 named "&\$% 1" and display the marker .  
 CALC:MARK:REF ON  
 CALC:MARK:REF:NAME 'Reference'  
 Display the reference marker and rename it "Reference".

**Manual operation:** See "[Marker Name](#)" on page 213

**CALCulate<Chn>:MARKer<Mk>:REFerence:MODE <Mode>**

Sets the reference marker to continuous or discrete mode. The marker doesn't have to be created before (CALCulate<Chn>:MARKer<Mk>[:STATe]ON), the mode can be assigned in advance.

**Suffix:**

<Chn> Channel number used to identify the active trace.  
 <Mk> Marker number in the range 1 to 10. This numeric suffix is ignored and may be set to any value.

**Parameters:**

<Mode> CONTInuous | DISCcrete  
 CONTInuous - marker can be positioned on any point of the trace, and its response values are obtained by interpolation.  
 DISCcrete - marker can be set to discrete sweep points only.  
 \*RST: CONT

**Example:**

Suppose that the active recall set contains an active trace no. 1.  
 CALC:MARK:REF:MODE DISC  
 CALC:MARK2:REF:MODE CONT  
 Create the reference marker in discrete mode and marker 2 in continuous mode.  
 CALC:MARK:REF ON; :CALC:MARK2 ON  
 Display the two markers. Due to the different modes the horizontal positions can be different.

**Manual operation:** See "[Discrete](#)" on page 213

**CALCulate<Chn>:MARKer<Mk>:REFerence:NAME <MarkerName>**

Defines a name for the reference marker. The marker doesn't have to be created before ([CALCulate<Chn>:MARKer<Mk>\[:STATe\] ON](#)), the name can be assigned in advance.

**Suffix:**

<Chn> Channel number used to identify the active trace.  
 <Mk> Marker number in the range 1 to 10. This numeric suffix is ignored and may be set to any value.

**Parameters:**

<MarkerName> Marker name (string parameter)  
 \*RST: 'R'

**Example:** See [CALCulate<Chn>:MARKer<Mk>:NAME](#)

**Manual operation:** See "[Marker Name](#)" on page 213

**CALCulate<Chn>:MARKer<Mk>:REFerence[:STATe] <Boolean>**

Creates the reference marker and assigns it to trace no. <Chn>.

**Suffix:**

<Chn> Channel number used to identify the active trace.  
 <Mk> Marker number in the range 1 to 10. This numeric suffix is ignored and may be set to any value.

**Parameters:**

<Boolean> ON | OFF - creates or removes the marker.  
 \*RST: OFF

**Example:** Suppose that the active recall set contains an active trace no. 1.  
 CALC:MARK:REF ON; :CALC:MARK ON  
 Create the reference marker and marker 1 and assign them to trace no. 1. The default position of both markers is the center of the sweep range.

**Manual operation:** See "[Mkr Stimulus / On / Delta Mode](#)" on page 211

**CALCulate<Chn>:MARKer<Mk>:REFerence:TYPE <Mode>**

Sets the reference to normal or fixed mode. The marker must be created before using [CALCulate<Chn>:MARKer<Mk>\[:STATe\] ON](#).

**Suffix:**

<Chn> Channel number used to identify the active trace.  
 <Mk> Marker number in the range 1 to 10. This numeric suffix is ignored and may be set to any value.

**Parameters:**

<Mode>                    NORMal | FIXed  
 NORMal - response value changes according to the measurement result.  
 FIXed - marker keeps its current response value.  
 \*RST:                    NORMal

**Example:**

```
CALC:MARK:REF ON; :CALC:MARK:REF:TYPE FIX
Create the reference marker and display it in the center of the
sweep range as a fixed marker.
CALC:MARK:REF:X 1GHz
Shift the marker horizontally. The response value remains fixed.
```

**Manual operation:** See "[Fixed](#)" on page 214

**CALCulate<Chn>:MARKer<Mk>:REFerence:X <MarkerValue>**

Defines the stimulus (in Cartesian diagrams: x-axis) value of the reference marker, which can (but doesn't have to) be displayed using `CALCulate<Chn>:MARKer<Mk>:REFerence[:STATe]ON`.

**Suffix:**

<Chn>                    Channel number used to identify the active trace.  
 <Mk>                    Marker number in the range 1 to 10. This numeric suffix is ignored and may be set to any value.

**Parameters:**

<MarkerValue>           Stimulus value of the reference marker.  
 Range:                -9.9E+11 Hz to +9.9E+11 Hz (for frequency sweeps); -999 dBm to +999 dBm (for power sweeps); 0 s to 127500 s (for time and CW mode sweeps)  
 Default unit: NN

**Example:**

```
Suppose that the active recall set contains an active trace no. 1
and that the sweep range for a frequency sweep starts at 1 GHz.
CALC:MARK:REF ON
Create the reference marker and display it in the center of the
sweep range.
CALC:MARK:REF:X 1GHz
Set the reference marker to the beginning of the sweep range.
CALC:MARK:REF:Y?
Query the measurement value at the reference marker position.
```

**Manual operation:** See "[Mkr Stimulus / On / Delta Mode](#)" on page 211



**CALCulate<Chn>:MARKer<Mk>:REFerence:Y?**

Returns the response (in Cartesian diagrams: y-axis) value of the reference marker. The reference marker must be created before using `CALCulate<Chn>:MARKer<Mk>:REFerence[:STATe] ON`.

**Suffix:**

<Chn> Channel number used to identify the active trace.  
 <Mk> Marker number in the range 1 to 10. This numeric suffix is ignored and may be set to any value.

**Example:** See `CALCulate<Chn>:MARKer<Mk>:REFerence:X`

**Usage:** Query only

**Manual operation:** See "Ref Mkr" on page 212

**CALCulate<Chn>:MARKer:SEARch:BFILter:RESult[:STATe] <Boolean>**

Shows or hides the bandfilter search results in the diagram area.

**Suffix:**

<Chn> Channel number used to identify the active trace.

**Parameters:**

<Boolean> ON - show the bandfilter search results. If no bandfilter search has been initiated before (`CALCulate<Chn>:MARKer<Mk>:FUNCTION:EXECuteBFILter`), nothing is displayed.  
 OFF - hide the bandfilter search results.  
 \*RST: OFF

**Example:** See `CALCulate<Chn>:MARKer<Mk>:BWIDth`

**Manual operation:** See "Result Off" on page 225

**CALCulate<Chn>:MARKer:SEARch:BFILter:RESult[:STATe]:AREA  
<HorizontalPos>, <VerticalPos>**

Moves the bandfilter search info field for the active trace <Chn> to one of nine predefined positions in the active diagram.

**Suffix:**

<Chn> Channel number used to identify the active trace.

**Parameters:**

<HorizontalPos> LEFT | MID | RIGHT  
 Horizontal position  
 <VerticalPos> TOP | MID | BOTTOm  
 Vertical position

**Example:** See `CALCulate<Chn>:MARKer<Mk>:BWIDth`

**Manual operation:** See "Bandpass Ref to Max" on page 223

**CALCulate<Chn>:MARKer<Mk>:SEARch:TRACking <Boolean>**

This command is only available if a search mode is active ([CALCulate<Chn>:MARKer<Mk>:FUNCtion:EXECute...](#))

It enables or disables tracking, which causes the search logic of the related marker(s) to be repeated after each sweep.

**Tip:** If the current search mode is a bandfilter or multiple peak search this command enables or disables the corresponding tracking.

**Suffix:**

<Chn> Channel number used to identify the active trace.

<Mk> Number of an existing marker in the range of 1 to 10.  
If a bandfilter search or a multiple peak search is active, tracking recalculates the whole marker set for each sweep and hence this suffix is ignored.

**Parameters:**

<Boolean> ON | OFF - enables or disables the marker tracking mode.  
\*RST: OFF

**Example:**

Suppose the active recall set contains an active trace no. 1.  
CALC:MARK ON; :CALC:MARK:FUNC:EXEC MAXimum  
Create marker no. 1 and assign it to trace no. 1. Activate a maximum search for marker no. 1.  
CALC:MARK:SEAR:TRAC ON  
Enable the tracking mode for the created marker.

**Manual operation:** See "[Tracking](#)" on page 216

**CALCulate<Chn>:MARKer<Mk>:SEARch:FORMat <SearchFormat>**

Selects the format in which the target value shall be specified (see [CALCulate<Chn>:MARKer<Mk>:TARGet](#) on page 452).

Each marker may have a different target format. The table below gives an overview on how a complex target value  $z = x + jy$  is converted.

Target Format	Description	Formula
MLINear	Magnitude of z, unconverted.	$ z  = \sqrt{x^2 + y^2}$
MLOGarithmic	Magnitude of z in dB	$\text{Mag}(z) = 20 \log z  \text{ dB}$
PHASe	Phase of z	$\varphi(z) = \arctan(y/x)$
UPHase	Unwrapped phase of z comprising the complete number of 360° phase rotations	$\Phi(z) = \varphi(z) + 2k \cdot 360^\circ$
REAL	Real part of z	$\text{Re}(z) = x$
IMAGinary	Imaginary part of z	$\text{Im}(z) = y$

Target Format	Description	Formula
SWR	(Voltage) Standing Wave Ratio	$SWR = (1 +  z ) / (1 -  z )$
DEFAult	Identical to trace format. <b>Note:</b> the Smith and Polar traces use "Lin Mag" as the default format for target value.	-

**Suffix:**

<Chn> Channel number used to identify the active trace

<Mk> Marker number in the range 1 to 10.

**Parameters:**

<SearchFormat> MLINear | MLOGarithmic | PHASe | UPHase | REAL | IMAGinary | SWR | DEFAult

Identifies the search format for the target value of the marker. See table above.

\*RST: DEFAult

**Example:**

Suppose channel 1's selected trace is POLar and marker 1 isn't yet created

```
:CALCULATE1:MARKER1 ON
```

Create/enable Marker 1

```
:CALCulate1:MARKer1:FUNctioN:SElect TARGET
```

Select TARGET search mode for marker 1

```
:CALCulate1:MARKer1:SEARch:FORMat?
```

Query the target format of marker 1. The result is DEF and for polar diagrams the default target format is "Phase".

```
:CALCulate1:MARKer1:FUNctioN:TARGET?
```

Query for the default target value; for "Phase" this is 0 (degrees)

```
:CALCulate1:MARKer1:SEARch:FORMat MLOGarithmic
```

Change the target search format to logarithmic magnitude

```
:CALCulate1:MARKer1:FUNctioN:TARGET?
```

Query for the default target value; for logarithmic magnitude this is 0 (dB)

```
:CALCulate1:MARKer1:FUNctioN:TARGET -3
```

Set the target value to -3 dB

```
:CALCulate1:MARKer1:FUNctioN:EXECute
```

Execute the target search for marker 1

```
:CALCulate1:MARKer1:FUNctioN:RESult?
```

Query for the results.

**Manual operation:** See "[Target Format](#)" on page 220

---

**CALCulate<Chn>:MARKer<Mk>[:STATe] <Boolean>**

Creates the marker numbered <Mk> and assigns it to trace no. <Chn>.

**Suffix:**

<Chn> Channel number used to identify the active trace.

<Mk> Marker number in the range 1 to 10. If unspecified the numeric suffix is set to 1.

**Parameters:**

<Boolean> ON | OFF – creates or removes the marker.  
\*RST: OFF

**Example:**

Suppose that the active recall set contains an active trace no. 1.  
CALC:MARK ON; MARK2 ON  
Create markers 1 and 2 and assign them to trace no. 1. The default position of both markers is the center of the sweep range.

**Manual operation:** See "[Mkr Stimulus / On / Delta Mode](#)" on page 211

**CALCulate<Chn>:MARKer[:STATe]:AREA <HorizontalPos>, <VerticalPos>**

Moves the marker info field for the active trace <Chn> to one of nine predefined positions in the active diagram.

**Suffix:**

<Chn> Channel number used to identify the active trace.

**Parameters:**

<HorizontalPos> LEFT | MID | RIGHT  
Horizontal position

<VerticalPos> TOP | MID | BOTTOm  
Vertical position

**Example:**

See [CALCulate<Chn>:MARKer<Mk>:Y?](#)

**Manual operation:** See "[Mkr 1 ... Mkr 10](#)" on page 211

**CALCulate<Chn>:MARKer<Mk>:TARGet <TargetSearchVal>**

Defines the target value for the target search of marker no. <Mk>, which can be activated using [CALCulate<Chn>:MARKer<Mk>:FUNCTION:EXECuteTARGet](#).

**Suffix:**

<Chn> Channel number used to identify the active trace.

<Mk> Marker number in the range 1 to 10.

**Parameters:**

<TargetSearchVal> Target search value of marker no. <Mk>. The value range and reset value depend on the selected target format (see [CALCulate<Chn>:MARKer<Mk>:SEARCH:FORMat](#) on page 450).

**Example:**

```
CALC:MARK ON
Create marker no. 1 and display it in the center of the sweep
range.
:CALC:MARK:TARG -10; FUNC:EXEC TARG
Define a target search value of -10 dB and start the target
search.
CALC:MARK:X?
Query the stimulus value corresponding to the target search
result.
```

**Manual operation:** See "[Target Value](#)" on page 220

### **CALCulate<Chn>:MARKer<Mk>:TYPE <Mode>**

Sets marker no. <Mk> to normal or fixed mode. The marker must be created before using `CALCulate<Chn>:MARKer<Mk>[:STATe] ON`.

**Suffix:**

<Chn> Channel number used to identify the active trace.  
 <Mk> Marker number in the range 1 to 10.

**Parameters:**

<Mode> NORMAL | FIXEd  
 NORMAL - response value changes according to the measurement result.  
 FIXEd - marker keeps its current response value.  
 \*RST:        NORMAL

**Example:**

```
CALC:MARK ON; :CALC:MARK:TYPE FIX
Create marker 1 and display it in the center of the sweep range
as a fixed marker.
CALC:MARK:X 1GHz
Shift the marker horizontally. The response value remains fixed.
```

**Manual operation:** See "[Fixed](#)" on page 214

### **CALCulate<Chn>:MARKer<Mk>:X <StimulusValue>**

Defines the stimulus (in Cartesian diagrams: x-axis) value of the marker no. <Mk>, which can (but doesn't have to) be created using `CALCulate<Chn>:MARKer<Mk>[:STATe] ON`.

**Suffix:**

<Chn> Channel number used to identify the active trace.  
 <Mk> Marker number in the range 1 to 10.

**Parameters:**

<StimulusValue> Stimulus value of marker no. <Mk>.  
 Range: -9.9E+11 Hz to +9.9E+11 Hz (for frequency sweeps) -999 dBm to +999 dBm (for power sweeps) 0 s to 127500 s for time and CW mode sweeps)  
 Default unit: NN

**Example:**

Suppose that the active recall set contains an active trace no. 1 and the sweep range for a frequency sweep starts at 1 GHz.

```
CALC:MARK ON
```

Create marker no. 1 and display it in the center of the sweep range.

```
CALC:MARK:X 1GHz
```

Set the marker to the beginning of the sweep range.

**Manual operation:** See "[Mkr Stimulus / On / Delta Mode](#)" on page 211

**CALCulate<Chn>:MARKer<Mk>:Y?**

Returns the response (in Cartesian diagrams: y-axis) value of marker no. <Mk>. The marker must be created before using `CALCulate<Chn>:MARKer<Mk>[:STATe] ON`.

**Suffix:**

<Chn> Channel number used to identify the active trace.

<Mk> Marker number in the range 1 to 10.

**Example:**

Suppose that the active recall set contains an active trace no. 1.

```
CALC:MARK ON
```

Create marker no. 1 and display it in the center of the sweep range.

```
CALC:MARK:Y?
```

Query the measurement value at the marker position.

```
CALC:MARK:STAT:AREA LEFT, TOP
```

For a subsequent check at the GUI or a hardcopy, move the info field to the top left position.

**Usage:** Query only

**Manual operation:** See "[Mkr 1 ... Mkr 10](#)" on page 211

**6.3.2.9 CALCulate:MATH...**

The `CALCulate:MATH...` commands permit processing of measured data in numerical expression format. The operators are +, -, \*, / and use of constants and data arrays are permitted.

CALCulate<Chn>:MATH[:EXPRession]:SDEFine.....	455
CALCulate<Chn>:MATH:FUNCtion.....	456
CALCulate<Chn>:MATH:MEMorize.....	456
CALCulate<Chn>:MATH:STATe.....	457
CALCulate<Chn>:MATH:WUNit[:STATe].....	457

### CALCulate<Chn>:MATH[:EXPRession]:SDEFine <Expression>

Defines a general mathematical relation between traces. To calculate and display the new mathematical trace, the mathematical mode must be switched on (CALCulate<Chn>:MATH:STATeON).

#### Suffix:

<Chn> Channel number used to identify the active trace.

#### Parameters:

<Expression> Operands, operators and functions; see table below.

#### Example:

```
*RST; :CALC:MATH:MEM
```

Copy the current state of the default trace 'Trc1' to a memory trace named 'Mem2[Trc1]'. The memory trace is not displayed.

```
CALC:MATH:SDEF 'Trc1 / Mem2[Trc1]'
```

Define a mathematical trace, dividing the data trace by the stored memory trace. The mathematical trace is not displayed.

```
CALC:MATH:STAT ON
```

Display the mathematical trace instead of the active data trace.

**Manual operation:** See "Data / Mem, Data – Mem" on page 169

Expressions defined via CALCulate<Ch>:MATH[:EXPRession]:SDEFine may contain the following elements:

Type	Complete List	Description
Operands	<Trace name>   activeTrc   Mem[activeTrc]	All traces and memory traces of the active recall set   Active trace   Active memory trace assigned to the active trace
Constants	e, pi   1, -1.2, 8e9   1 + 2j, 2 + 1e-9j	Constants   Real values in decimal or exponential format   Complex numbers
Operators	- + , - , * , / , ^	Basic arithmetic operations; ^ for exponentiation
Functions	linMag (), dBMag (), Arg (), Re (), Im (), log (), ln (), tan (), atan (), sin (), asin (), cos (), acos (), Min ( ... , ... ), Max ( ... , ... )	Mathematical functions with one or two arguments
Special Functions	StimVal	Current stimulus value (see description of operators for User Defined Math)
Brackets	( )	Priority of operations in complex expressions

**CALCulate<Chn>:MATH:FUNCtion <Mode>**

Defines a simple mathematical relation between the active trace and the active memory trace to calculate a new mathematical trace and displays the mathematical trace.

**Note:** This command places some restrictions on the mathematical expression and the operands. Use `CALCulate<Chn>:MATH[:EXPRession]:SDEFine` to define general expressions.

**Suffix:**

<Chn> Channel number used to identify the active trace.

**Parameters:**

<Mode> NORMal | ADD | SUBTract | MULTipty | DIVide

NORMal – Math. trace = active data trace

ADD – Math. trace = data + memory

SUBTract – Math. trace = data - memory

MULTipty – Math. trace = data \* memory

DIVide – Math. trace = data / memory

\*RST: NORMal

**Example:**

```
*RST; :CALC:MATH:MEM
```

Copy the current state of the default trace 'Trc1' to a memory trace named 'Mem2[Trc1]'. The memory trace is not displayed.

```
CALC:MATH:FUNC DIV
```

Define a mathematical trace, dividing the data trace by the stored memory trace. The mathematical trace is displayed instead of the active data trace.

```
CALC:MATH:STAT?
```

The response is 1 (mathematical mode switched on, mathematical trace displayed).

**Manual operation:** See "[Data / Mem, Data – Mem](#)" on page 169

**CALCulate<Chn>:MATH:MEMorize**

Copies the current state of the active data trace to a memory trace. If a mathematical trace is active, the data trace associated with the mathematical trace is copied. The memory trace is named `Mem<n>[<Data_Trace>]` where `<n>` counts all data and memory traces in the active recall set in chronological order, and `<Data_Trace>` is the name of the associated (copied) data trace.

The exact function of the command depends on the number of memory traces associated to the active data trace:

- If no memory trace is associated to the active trace, a new memory trace is generated.
- If several memory traces are associated to the active trace, the current measurement data overwrites the last generated or changed memory trace.



**Note:** To copy a trace to the memory without overwriting an existing memory trace or define a memory trace name, use `TRACe:COPIY`  
`<MemTraceName>, <DataTraceName>`. To copy an active mathematical trace use  
`TRACe:COPIY:MATH<MemTraceName>, <DataTraceName>`

**Suffix:**

`<Chn>` Channel number used to identify the active trace.

**Example:**

```
*RST; :CALC:MATH:MEM
```

Copy the current state of the default trace 'Trc1' to a memory trace named 'Mem2[Trc1]'. The memory trace is not displayed.

```
DISP:WIND:TRAC2:FEED 'Mem2[Trc1]'
```

Display the created memory trace in the active diagram area (diagram area no. 1).

**Usage:**

Event

**Manual operation:** See "[Data to <Destination>](#)" on page 168

**CALCulate<Chn>:MATH:STATe <Boolean>**

Activates or deactivates the mathematical mode where the mathematical trace defined via `CALCulate<Chn>:MATH[:EXPRession]:SDEFine` is calculated and displayed instead of the active data trace. The command is not valid for mathematical traces calculated via `CALCulate<Chn>:MATH:FUNCTion`.

**Suffix:**

`<Chn>` Channel number used to identify the active trace.

**Parameters:**

`<Boolean>` ON – display the active data trace.  
 OFF – display the mathematical trace.

```
*RST: OFF
```

**Example:**

```
*RST; :CALC:MATH:MEM
```

Copy the current state of the default trace 'Trc1' to a memory trace named 'Mem2[Trc1]'. The memory trace is not displayed.

```
CALC:MATH:SDEF 'Trc1 / Mem2[Trc1]'
```

Define a mathematical trace, dividing the data trace by the stored memory trace. The mathematical trace is not displayed  
`CALC:MATH:STAT ON`

Display the mathematical trace instead of the active data trace.

**Manual operation:** See "[Trace Math](#)" on page 169

**CALCulate<Chn>:MATH:WUNit[:STATe] <Boolean>**

Controls the conversion and formatting of the mathematic expression defined via `CALCulate<Chn>:MATH[:EXPRession]:SDEFine` (see "[Result is Wave Quantity](#)" on page 172).

**Suffix:**

<Chn> Channel number used to identify the active trace.

**Parameters:**

<Boolean> ON –"Result is Wave Quantity" enabled; the analyzer assumes that the result of the mathematical expression represents a voltage.  
 OFF –"Result is Wave Quantity" disabled; the analyzer assumes that the result of the mathematical expression is dimensionless.  
 \*RST: OFF

**Example:**

```
*RST; SWE:TYPE POW
CALC:PAR:SDEF 'Trc1', 'a1'
Reset the instrument, activate a power sweep, and select a
wave quantity a1 for the trace Trc1.
DISP:WIND:TRAC:FEED 'Trc1'
Display the generated trace in the active window.
CALC:MATH:SDEF 'StimVal'; STAT ON
Define a mathematical trace, dividing the data trace by the
stored memory trace. Display the mathematical trace instead of
the active data trace.
CALC:MATH:WUN ON
Take into account that the stimulus value is a voltage (derived
from the source power) rather than a dimensionless quantity.
The y-axis range of the mathematical trace now exactly corre-
sponds to the power sweep range.
```

**Manual operation:** See "[Mathematical Expression](#)" on page 171

**6.3.2.10 CALCulate:PARAmeter...**

The CALCulate:PARAmeter... commands assign names and measurement parameters to traces. The commands are device-specific.

CALCulate<Ch>:PARAmeter:CATalog?	459
CALCulate<Ch>:PARAmeter:CATalog:SENDED?	459
CALCulate<Ch>:PARAmeter:DEFine:SGROUP	459
CALCulate<Ch>:PARAmeter:DELeTe	461
CALCulate:PARAmeter:DELeTe:ALL	462
CALCulate<Ch>:PARAmeter:DELeTe:CALL	462
CALCulate:PARAmeter:DELeTe:MEMory	462
CALCulate<Ch>:PARAmeter:DELeTe:CMEMory	462
CALCulate<Ch>:PARAmeter:DELeTe:SGROUP	462
CALCulate<Ch>:PARAmeter:MEASure	463
CALCulate<Ch>:PARAmeter:MEASure:SENDED	463
CALCulate<Ch>:PARAmeter:SDEFine	464
CALCulate<Ch>:PARAmeter:SDEFine:SENDED	466
CALCulate<Ch>:PARAmeter:SELeT	466

**CALCulate<Ch>:PARAmeter:CATalog?**

Returns the trace names and measurement parameters of all traces assigned to a particular channel.

The result is a string containing a comma-separated list of trace names and measurement parameters, e.g. 'CH4TR1, S11, CH4TR2, S12'. The measurement parameters are returned according to the naming convention of [CALCulate<Ch>:PARAmeter:SDEFine](#). The order of traces in the list reflects their creation time: The oldest trace is the first, the newest trace is the last trace in the list.

**Suffix:**

<Ch> Channel number. If unspecified the numeric suffix is set to 1.

**Example:**

```
CALC4:PAR:SDEF 'Ch4Tr1', 'S11'
```

Create channel 4 and a trace named Ch4Tr1 to measure the input reflection coefficient S<sub>11</sub>.

```
CALC4:PAR:CAT?
```

Query the traces assigned to channel 4. If Ch4Tr1 is the only trace assigned to channel 4, the response is 'CH4TR1, S11'.

**Usage:**

Query only

**CALCulate<Ch>:PARAmeter:CATalog:SENDED?**

Returns the trace names and measurement parameters of all traces assigned to a particular channel.

Similar to [CALCulate<Ch>:PARAmeter:CATalog?](#), but in presence of balanced ports this command distinguishes between

- single-ended S-parameters for **logical** ports (SSS<Li><Lj>)
- "raw" single-ended S-parameters referring to **physical** ports (S<Pi><Pj>)

**Suffix:**

<Ch> Channel number. If unspecified the numeric suffix is set to 1.

**Usage:**

Query only

**CALCulate<Ch>:PARAmeter:DEFine:SGRoup <LogicalPort1>, <LogicalPort2>...**

Creates the traces for all S-parameters associated with a group of logical ports (S-parameter group). The traces can be queried using [CALCulate<Ch>:DATA:SGRoup?](#).

Traces must be selected to become active traces; see [CALCulate<Ch>:PARAmeter:SElect](#).

**Note:** Each channel can contain a single S-parameter group only. Defining a new S-parameter group deletes the previous one. Use [CALCulate<Ch>:PARAmeter:DElete:SGRoup](#) on page 462 to delete the current S-group explicitly.

**Suffix:**

&lt;Ch&gt;

Channel number. <Ch> may be used to reference a previously defined channel. If <Ch> does not exist, it is generated with default channel settings.

**Parameters:**

&lt;LogicalPort1&gt;

Logical (balanced or unbalanced) port numbers. The port numbers must be in ascending order, their number is limited by the test ports of the analyzer. With n logical port numbers, the command generates  $n^2$  traces. The traces correspond to the following S-parameters:

$$S_{\langle \text{log\_port1} \rangle \langle \text{log\_port1} \rangle}, S_{\langle \text{log\_port1} \rangle \langle \text{log\_port2} \rangle} \dots S_{\langle \text{log\_port1} \rangle \langle \text{log\_port} \langle n \rangle \rangle}$$

...

$$S_{\langle \text{log\_port} \langle n \rangle \rangle \langle \text{log\_port1} \rangle}, S_{\langle \text{log\_port} \langle n \rangle \rangle \langle \text{log\_port2} \rangle} \dots S_{\langle \text{log\_port} \langle n \rangle \rangle \langle \text{log\_port} \langle n \rangle \rangle},$$

e.g.  $S_{11}, S_{12}, S_{21}, S_{22}$  for <log\_port1> = 1, <log\_port2> = 2. If only one logical port <log\_port1> is specified, a single trace with the reflection coefficient  $S_{\langle \text{log\_port1} \rangle \langle \text{log\_port1} \rangle}$  is created.

**Trace names**

The generated traces are assigned the following trace names:

<Ch\_name>\_SG\_S<log\_port1><log\_port1>,  
 <Ch\_name>\_SG\_S<log\_port1><log\_port2> ...  
 <Ch\_name>\_SG\_S<log\_port1><log\_port<n>> ...<Ch\_name>\_S  
 G\_S<log\_port<n>><log\_port1>,  
 <Ch\_name>\_SG\_S<log\_port<n>><log\_port2>...  
 <Ch\_name>\_SG\_S<log\_port<n>><log\_port<n>>,  
 e.g. Ch1\_SG\_S11, Ch1\_SG\_S12, Ch1\_SG\_S21, Ch1\_SG\_S22  
 for <Ch\_name> = Ch1, <log\_port1> = 1, <log\_port2> = 2. The  
 trace names are displayed in the "Channel Manager" and in the  
 "Trace Manager" dialogs where they can be changed manually.  
 The <Ch\_name> is defined via  
 CONFigure:CHANnel<Ch>:NAME '<Ch\_name>'.  
 Trace names are important for referencing the generated traces;  
 see program example below.

&lt;LogicalPort2&gt;

**Example:**

```
CALC2:PAR:DEF:SGR 1,2
```

Create channel 2 and four traces to measure the two-port S-parameters  $S_{11}$ ,  $S_{12}$ ,  $S_{21}$ ,  $S_{22}$ . The traces are not displayed.

```
DISP:WIND:TRAC2:FEED 'Ch2_SG_S11'
DISP:WIND:TRAC3:FEED 'Ch2_SG_S12'
DISP:WIND:TRAC4:FEED 'Ch2_SG_S21'
DISP:WIND:TRAC5:FEED 'Ch2_SG_S22'
```

Display the four traces in the diagram no. 1.

```
INIT2:CONT OFF; :INIT2:IMMEDIATE; *OPC
```

Perform a complete sweep in channel no. 2 to ensure the traces are completely "filled" with data.

```
CALC2:DATA:SGR? SDAT
```

Retrieve all four traces as unformatted data (real and imaginary part at each sweep point). The analyzer first returns the complete  $S_{11}$  trace, followed by the  $S_{12}$ ,  $S_{21}$ , and  $S_{22}$  traces.

```
CALC2:PAR:DEL:SGR
```

Delete the previously created port group.

**Manual operation:** See ["All S-Params"](#) on page 129

---

#### **CALCulate<Ch>:PARAmeter:DELeTe <TraceName>**

Deletes a trace with a specified trace name and channel.

##### **Suffix:**

<Ch> Channel number.

##### **Setting parameters:**

<TraceName> Trace name, e.g. 'Trc4'. See "Rules for trace names" in [Chapter 4.2.4.2, "Trace Manager \(Dialog\)"](#), on page 164.

##### **Example:**

```
CALCulate4:PARAmeter:SDEFine 'Ch4Tr1', 'S11'
```

Create channel 4 and a trace named Ch4Tr1 to measure the input reflection coefficient  $S_{11}$ .

```
CALCulate4:PAR:CAT?
```

Query the traces assigned to channel 4. Ch4Tr1 is the only trace assigned to channel 4, so the response is

```
'CH4TR1,S11'
```

```
CALCulate4:PARAmeter:SDEFine 'CH4TR2', 'S21';
SDEFine 'CH4TR3', 'S12'; SDEFine 'CH4TR4',
'S22'
```

Create three more traces for the remaining 2-port S-parameters.

```
CALCulate4:PARAmeter:DELeTe 'CH4TR1'
```

Delete the first created trace.

```
CALCulate4:PARAmeter:DELeTe:CALL
```

Delete the remaining three traces in channel 4.

```
CALCulate:PARAmeter:DELeTe:ALL
```

Delete all traces, including the default trace Trc1 in channel 1.

**Usage:** Setting only

**Manual operation:** See ["Delete Trace"](#) on page 164

---

**CALCulate:PARAmeter:DELeTe:ALL**

Deletes all traces in all channels of the active recall set, including the default trace `Trc1` in channel 1. The manual control screen shows "No Trace".

**Example:** See `CALCulate<Ch>:PARAmeter:DELeTe`

**Usage:** Event

**Manual operation:** See "Delete Trace" on page 164

---

**CALCulate<Ch>:PARAmeter:DELeTe:CALL**

Deletes all traces in channel no. `<Ch>`.

**Suffix:**  
`<Ch>` Channel number

**Example:** See `CALCulate<Ch>:PARAmeter:DELeTe`

**Usage:** Event

**Manual operation:** See "Delete Trace" on page 164

---

**CALCulate:PARAmeter:DELeTe:MEMory**

Deletes all memory traces in all channels.

**Usage:** Event

**Manual operation:** See "Delete all Mem" on page 175

---

**CALCulate<Ch>:PARAmeter:DELeTe:CMEMory**

Deletes all memory traces in channel `<Ch>`.

**Suffix:**  
`<Ch>` Channel number

**Usage:** Event

---

**CALCulate<Ch>:PARAmeter:DELeTe:SGRoup**

Deletes a group of logical ports (S-parameter group), previously defined via `CALCulate<Ch>:PARAmeter:DEFine:SGRoup`.

**Suffix:**  
`<Ch>` Channel number. `<Ch>` may be used to reference a previously defined channel. If `<Ch>` does not exist, it is generated with default channel settings.

**Example:** See `CALCulate<Ch>:PARAmeter:DEFine:SGRoup`

**Usage:** Event

**CALCulate<Ch>:PARAmeter:MEASure <TraceName>, <Result>**

Assigns a measurement result to an **existing** trace. The query returns the result assigned to the specified trace (no second parameter; see example).

**Note:** To create a new trace and at the same time assign the attributes, use `CALCulate<Ch>:PARAmeter:SDEFine`. To display the trace, create a diagram (`DISPlay[:WINDow<Wnd>][:STATe]ON`) and assign the trace to this diagram (`DISPlay[:WINDow<Wnd>]:TRACe<WndTr>:FEED`); see example below.

Traces must be selected to become active traces; see `CALCulate<Ch>:PARAmeter:SElect`. `CALCulate<Ch>:PARAmeter:CATalog?` returns a list of all defined traces. You can open the "Trace Manager" dialog to obtain an overview of all channels and traces, including the traces that are not displayed.

**Suffix:**

<Ch> Channel number of an existing channel containing the referenced trace.

**Parameters:**

<TraceName> Trace name, string variable, e.g. 'Trc4'. See "Rules for trace names" in "[Trace Manager Table](#)" on page 165. Trace names must be unique across all channels and diagrams.

<Result> Measurement parameter (string variable); see [Table 6-4](#).  
A query of a wave quantity 'xy'  
returns 'xyD<n><Detector>', where <n> numbers the source (drive) port, and <Detector> denotes the detector setting (SAM for a "Normal" (sample), AVG for an "AVG Real Imag", AMP for an AVG Mag Phase detector). A query of a ratio 'x/y' returns 'xD<n>/yD<m><Detector>', where <n> and <m> number the source ports

**Example:**

```
CALC4:PAR:SDEF 'Ch4Tr1', 'S11'
```

Create channel 4 and a trace named Ch4Tr1 to measure the input reflection coefficient  $S_{11}$ .

```
CALC4:PAR:MEAS 'Ch4Tr1', 'a1'
```

Change the measurement parameter of the trace and measure the wave quantity  $a_1$ .

```
CALC4:PAR:MEAS? 'Ch4Tr1'
```

Query the measured quantity. The response is 'A1D1SAM'.

**Manual operation:** See "[S-Parameter](#)" on page 128

**CALCulate<Ch>:PARAmeter:MEASure:SENDED <TraceName>, <Result>**

Assigns a measurement result to an **existing** trace. The query returns the result assigned to the specified trace (no second parameter; see example).

Similar to `CALCulate<Ch>:PARAmeter:MEASure`, but in presence of balanced ports this command distinguishes between

- single-ended S-parameters for **logical** ports (`SSS<Li><Lj>`)

- "raw" single-ended S-parameters referring to **physical** ports (S<Pi><Pj>)

**Suffix:**

<Ch> Channel number

**Setting parameters:**

<TraceName> Trace name

<Result> Measured quantity

**Manual operation:** See "[S-Parameter](#)" on page 128

**CALCulate<Ch>:PARAmeter:SDEFine <TraceName>, <Result>**

Creates a trace and assigns a channel number, a name and a measurement parameter to it. The trace becomes the active trace in the channel but is not displayed.

**Note:** To display the trace defined via `CALCulate<Ch>:PARAmeter:SDEFine`, create a diagram (`DISPlay[:WINDow<Wnd>][:STATe]ON`) and assign the trace to this diagram (`DISPlay[:WINDow<Wnd>]:TRACe<WndTr>:FEED`); see example below. `CALCulate<Ch>:PARAmeter:MEASure` changes the measurement result of an existing trace.

To select an existing trace as the active trace, use `CALCulate<Ch>:PARAmeter:SElect`. You can open the trace manager to obtain an overview of all channels and traces, including the traces that are not displayed.

**Tip:** This command has no query form. Use `CALCulate<Ch>:PARAmeter:MEASure 'TraceName'` to query the measurement result of the trace. `CALCulate<Ch>:PARAmeter:CATalog?` returns a list of all defined traces.

**Suffix:**

<Ch> Channel number. <Ch> may be used to reference a previously defined channel. If <Ch> does not exist, it is generated with default channel settings.

**Setting parameters:**

<TraceName> Trace name, string variable, e.g. 'Trc4'. See "Rules for trace names" in "[Trace Manager Table](#)" on page 165. Trace names must be unique across all channels and diagrams.  
If a trace with the selected trace name already exists, the analyzer behaves as follows: If the existing trace is assigned to the same channel as the new trace, it is deleted. The new trace is not automatically assigned to a diagram area; see note above. If the existing trace is assigned to a different channel, no new trace can be created. The analyzer returns an error message.

<Result> Measurement result (string variable), see table below.



<b>Example:</b>	<pre>CALC4:PAR:SDEF 'Ch4Tr1', 'S11'</pre> <p>Create channel 4 and a trace named Ch4Tr1 to measure the input reflection coefficient S<sub>11</sub>.</p> <pre>DISP:WIND2:STAT ON</pre> <p>Create diagram area no. 2.</p> <pre>DISP:WIND2:TRAC:FEED 'CH4TR1'</pre> <p>Display the generated trace in diagram area no. 2.</p>
<b>Usage:</b>	Setting only
<b>Manual operation:</b>	See " <a href="#">S-Parameter</a> " on page 128

Table 6-4: String identifiers for measurement results

<b>Note:</b>	
All port numbers in a result identifier refer to <b>logical (=DUT) ports</b> ; to avoid ambiguities they must be represented by the same number of digits (e.g. S21 or S0201). The valid port numbers are determined by the channel's logical port configuration	
For a unidirectional R&S ZND (see <a href="#">Chapter 3.1.4.2, "R&amp;S ZND: Unidirectional vs. Bidirectional Operation"</a> , on page 16) logical port 2 (= physical port 2) cannot be used as the driving port and hence "reverse direction" wave quantities and related parameters are not available available.	
For details about the measurement results see <a href="#">Chapter 3.3, "Measurement Results"</a> , on page 48.	
'S11'   'S12'   ...   'S0101'   ...	Single-ended S-parameters S<i><j> for logical (DUT) ports <i> and <j>.
'SCD11'   ...	S-parameters involving balanced ports must be specified in the form S<m_i><m_j><i><j>, where <m_i> and <m_j> denote the port modes of the related logical ports <i> and <j>. In general, for the port modes <m_i><m_j> all pairs of D (differential, balanced), C (common, balanced) and S (single-ended, unbalanced) are allowed.
'Y11'   ...   'YSS11'   ...   'YCC11'   ...   'YDD11'   'Z11'   ...   'ZSS11'   ...   'ZCC11'   ...   'ZDD11'   ...	Short-circuit Y-parameters and open-circuit Z-parameters with port modes and port numbers like for normal mode S-parameters.  Selecting a parameter Y...<n><m> or Z...<n><m> sets the range of logical port numbers to be considered for the Y and Z-parameter measurement to <n>:<m>.
'Y-S11'   ...   'Y-SSS11'   ...   'Y-SCC11'   ...   'Y-SDD11'   'Z-S11'   ...   'Z-SSS11'   ...   'Z-SCC11'   ...   'Z-SDD11'   ...	S-parameters converted to matched-circuit admittances and impedances with port modes and port numbers like for normal mode S-parameters.
'A1'   ...   'A01'   ...   'B1'   ...   'B01'   ...   'A1SAM'   'A1AVG'   'A1AMP'	Wave quantities with logical port numbers like for normal mode S-parameters. The strings SAM, AVG, AMP appended to the wave quantities denote a normal (sample, SAM), AVG Real Imag (AVG), or AVG Mag Phase (AMP) detector. The observation time for average detectors is set via [SENSe<Ch>:]SWEp:DETECTOR:TIME.
'A1D2'   ...   'A01D02'   ...   'B1D2'   ...   'B01D02'   ...   'A1D1SAM'   'A1D1AVG'   'A1D1AMP'   ...	Wave quantities A<meas>D<drive> (for a wave) and B<meas>D<drive> (for b wave) for logical ports <meas> and <drive>. The strings SAM, AVG, AMP appended to the wave quantities denote a normal (sample, SAM), AVG Real Imag (AVG), or AVG Mag Phase (AMP) detector.
'B2/A1'   ...   'B02/A01'   ...   'B2/A1SAM'   'B2/A1AVG'   'B2/A1AMP'   ...	Ratio of wave quantities with port numbers like for normal mode S-parameters. The strings SAM, AVG, AMP appended to the wave quantities denote a normal (sample, SAM), AVG Real Imag (AVG), or AVG Mag Phase (AMP) detector.
'B2D1/A1D1'   ...   'B02D01/A01D01'   ...   'B2D1/A1D1SAM'   'B2D1/A1D1AVG'   'B2D1/A1D1AMP'   ...	Ratios of wave quantities. The strings SAM, AVG, AMP appended to the wave quantities denote a normal (sample, SAM), AVG Real Imag (AVG), or AVG Mag Phase (AMP) detector.

'IMB1-23'   'IMB23-1'   'IMB1-24'   ...	Differential Imbalance parameters between a balanced and two single-ended logical ports
'KFAC21'   'KFAC12'   ...	Stability factor K (for unbalanced ports only)
'MUF121'   'MUF112'   ...	Stability factor 1 (for unbalanced ports only)
'MUF221'   'MUF212'   ...	Stability factor 2 (for unbalanced ports only)
'Pmtr1D1'   'Pmtr2D2'	Power sensor measurement using a power meter 'Pmtr<no>' and analyzer source port 'D1' or 'D2'

\*) Selecting a parameter Y...<n><m> or Z...<n><m> sets the range of port numbers to be considered for the Y and Z-parameter measurement to <n>:<m>.

---

#### **CALCulate<Ch>:PARAmeter:SDEFine:SENDED** <TraceName>, <Result>

Creates a trace and assigns a channel number, a name and a measurement parameter to it. The trace becomes the active trace in the channel but is not displayed.

Similar to [CALCulate<Ch>:PARAmeter:SDEFine](#), but in presence of balanced ports this command distinguishes between

- single-ended S-parameters for **logical** ports ([SSS<Li><Lj>](#))
- "raw" single-ended S-parameters referring to **physical** ports ([S<Pi><Pj>](#))

#### **Suffix:**

<Ch> Channel number

#### **Setting parameters:**

<TraceName> Trace name

<Result> Measured quantity

**Usage:** Setting only

**Manual operation:** See "[S-Parameter](#)" on page 128

---

#### **CALCulate<Ch>:PARAmeter:SElect** <TraceName>

Selects an existing trace as the active trace of the channel. All trace commands without explicit reference to the trace name act on the active trace (e.g.

[CALCulate<Chn>:FORMat](#)). [CALCulate<Ch>:PARAmeter:SElect](#) is also necessary if the active trace of a channel has been deleted.

#### **Suffix:**

<Ch> Channel number.

#### **Parameters:**

<TraceName> Trace name, e.g. 'Trc4'. See "Rules for trace names" in "[Trace Manager Table](#)" on page 165.

**Example:**

```
CALC4:PAR:SDEF 'Ch4Tr1', 'S11'
```

Create channel 4 and a trace named Ch4Tr1 to measure the input reflection coefficient  $S_{11}$ . The trace is the active trace in channel 4.

```
CALC4:PAR:SDEF 'Ch4Tr2', 'S22'
```

Create another trace named Ch4Tr2 to measure the output reflection coefficient  $S_{22}$ . Again this new trace becomes the active trace in channel 4.

```
CALC4:PAR:SEL 'Ch4Tr1'
```

Select the first trace Ch4Tr1 as the active trace.

```
CALC4:FORM MLIN
```

Calculate the magnitude of  $S_{11}$  and display it in a linearly scaled Cartesian diagram.

### 6.3.2.11 CALCulate:PHOLd...

The CALCulate:PHOLd... commands control the max hold (peak hold) function.

---

**CALCulate<Chn>:PHOLd <HoldFunc>**

Enables, disables, or restarts the max hold and the min hold functions.

**Suffix:**

<Chn> Channel number used to identify the active trace.

**Parameters:**

<HoldFunc> MIN | MAX | OFF  
 MIN - Enable the min hold function.  
 MAX - enable the max hold function.  
 OFF - disable the max hold or min hold function.  
 \*RST: OFF

**Example:**

```
*RST; :CALC:PHOL MAX
```

Reset the instrument and enable the max hold function.

```
CALC:PHOL OFF; PHOL MAX
```

Restart max hold.

**Manual operation:** See "Hold" on page 188

### 6.3.2.12 CALCulate:RIPPlE...

The CALCulate:RIPPlE... commands define the ripple limits and control the ripple limit check.

CALCulate<Chn>:RIPPlE:CONTRol:DOMain.....	468
CALCulate<Chn>:RIPPlE:DATA.....	469
CALCulate<Chn>:RIPPlE:DELeTe:ALL.....	469
CALCulate<Chn>:RIPPlE:DISPlay[:STATe].....	470
CALCulate:RIPPlE:DISPlay:RESult:ALL[:STATe].....	470
CALCulate<Chn>:RIPPlE:FAIL?.....	471
CALCulate:RIPPlE:FAIL:ALL?.....	471

CALCulate<Chn>:RIPple:RDOMain:FORMat.....	471
CALCulate<Chn>:RIPple:SEGment:COUNt?.....	472
CALCulate<Chn>:RIPple:SEGment<Seg>:LIMit.....	472
CALCulate<Chn>:RIPple:SEGment<Seg>:RESult?.....	473
CALCulate<Chn>:RIPple:SEGment<Seg>[:STATe].....	474
CALCulate<Chn>:RIPple:SEGment<Seg>:STIMulus:START.....	474
CALCulate<Chn>:RIPple:SEGment<Seg>:STIMulus:STOP.....	474
CALCulate<Chn>:RIPple:SOUNd[:STATe].....	475
CALCulate<Chn>:RIPple:STATe.....	475
CALCulate<Chn>:RIPple:STATe:AREA.....	475
CALCulate<Chn>:RIPple:CLEar.....	476

### CALCulate<Chn>:RIPple:CONTrol:DOMain <SweepType>

Deletes the existing ripple limit ranges and (re-)defines the physical units of the stimulus values of the ripple limit lines. The unit of the ripple limit is defined via `CALCulate<Chn>:RIPple:RDOMain:FORMat`.

#### Suffix:

<Chn> Channel number used to identify the active trace.

#### Setting parameters:

<SweepType> FLIN | FLOG | FSEG | FSINgle | TLIN | TLOG | PLIN | PLOG | PSINgle

Keywords for the units of the stimulus values; frequency, power, and time units. The selected unit must be compatible with the sweep type ( [SENSe<Ch>:] SWEep:TYPE on page 677); otherwise the ripple limit lines cannot be displayed and no ripple limit check is possible.

\*RST: FLIN

Default unit: Hz (for FLIN, FLOG, FSEG, and FSINgle), s (for TLIN and TLOG), dBm (for PLIN, PLOG and PSINgle).

#### Example:

```
SWE:TYPE POW
```

Select a power sweep.

```
CALC:RIPP:CONT:DOM PLIN
```

Delete all existing ripple limit ranges and select level units for the ripple limit of the active trace.

```
CALC:RIPP:DATA 1, -10, -5, 3
```

Define and enable a ripple limit range in the stimulus range between -10 dBm and -5 dBm, assigning a ripple limit of 3 dB.

#### Usage:

Setting only

**Manual operation:** See "Add / Insert / Delete / Delete All / Align All" on page 204

**CALCulate<Chn>:RIPple:DATA <RippleLimRange>...**

Adds and enables/disables an arbitrary number of ripple limit ranges, assigning the stimulus values and the ripple limits. See [Chapter 3.4.1.2, "Rules for Ripple Test Definition"](#), on page 65.

**Note:** This command does not overwrite existing ripple limit ranges. The defined ranges are appended to the range list as new ranges. Use the `CALCulate<Chn>:RIPple:SEGment<Seg>...` commands to change existing ripple limits.

**Suffix:**

<Chn> Channel number used to identify the active trace.

**Parameters:**

<RippleLimRange> Parameter list in the format <Type>, <StartStimulus>, <StopStimulus>, <RippleLimit>{, <Type>, <StartStimulus>, <StopStimulus>, <RippleLimit>}, where:

- <Type> – Boolean identifier for the ripple limit range type. 1 for ripple limit range on (with limit check). 0 for ripple limit range off: The range is defined, but no limit check result displayed. The result is still available via `CALCulate<Chn>:RIPple:SEGment<Seg>:RESult?`.
- <StartStimulus> – stimulus value of the first point of the ripple limit range. The unit is adjusted to the sweep type of the active channel (`[SENSe<Ch>:]SWEep:TYPE`).
- <StopStimulus> – stimulus value of the last point of the ripple limit range. The unit is adjusted to the sweep type.
- <RippleLimit> – ripple limit in the range. The unit is adjusted to the format of the active trace (`CALCulate<Chn>:FORMat`).

Range: Virtually no restriction for ripple limit ranges.  
 \*RST: n/a (no ripple limit line defined after a reset)  
 Default unit: Stimulus values: Hz for frequency sweeps, dBm for power sweeps, s for time and CW mode sweeps.  
 Ripple limit: see above.

**Example:**

```
*RST; CALC:RIPP:DATA 1, 1500000000, 2000000000,
3, 1, 2000000000, 3000000000, 5
```

Define and enable a ripple limit range in the stimulus range between 1.5 GHz and 2 GHz, assigning a ripple limit of +3 dB. Define and enable a second ripple limit range in the stimulus range between 2 GHz and 3 GHz, assigning a ripple limit of +5 dB.

```
CALC:RIPP:DISP ON
```

Show the ripple limits in the active diagram.

**Manual operation:** See ["Add / Insert / Delete / Delete All / Align All"](#) on page 204

**CALCulate<Chn>:RIPple:DELeTe:ALL**

Deletes all ripple limit ranges.

**Suffix:**  
 <Chn> Channel number used to identify the active trace.

**Example:** \*RST; CALC:RIPP:DATA 1,1500000000, 2000000000, 3, 1, 2000000000, 3000000000, 5  
 Define and enable a ripple limit range in the stimulus range between 1.5 GHz and 2 GHz, assigning a ripple limit of +3 dB. Define and enable a second ripple limit range in the stimulus range between 2 GHz and 3 GHz, assigning a ripple limit of +5 dB.  
 CALC:RIPP:DEL:ALL  
 Delete both created ripple limit ranges.

**Usage:** Event

**Manual operation:** See ["Add / Insert / Delete / Delete All / Align All"](#) on page 204

#### **CALCulate<Chn>:RIPple:DISPlay[:STATe] <Boolean>**

Displays or hides all ripple limit lines (including all ranges) associated to the active trace.

**Suffix:**  
 <Chn> Channel number used to identify the active trace.

**Parameters:**  
 <Boolean> ON | OFF - ripple limit line on or off.

\*RST: OFF

**Example:** \*RST; CALC:RIPP:DATA 1,1500000000, 2000000000, 3

Define and enable a ripple limit range in the stimulus range between 1.5 GHz and 2 GHz, assigning a ripple limit of +3 dB.

CALC:RIPP:DISP ON

Show the ripple limit range in the active diagram.

**Manual operation:** See ["Show Ripple Limits"](#) on page 202

#### **CALCulate:RIPple:DISPlay:RESult:ALL[:STATe] <Enable>**

Configures the display of ripple check info fields for the active recall set.

**Parameters:**  
 <Enable> ON - Info fields are displayed for all traces, for which a limit check is enabled.

OFF - Only the info field for the active trace is displayed (if the ripple check is enabled for this trace).

\*RST: OFF

**Manual operation:** See ["Show Results All Traces"](#) on page 203

**CALCulate<Chn>:RIPple:FAIL?**

Returns a 0 or 1 to indicate whether or not the global ripple limit check has failed.

**Tip:** Use `CALCulate<Chn>:RIPple:SEGment<Seg>:RESult?` to query the result for a single ripple limit range.

**Suffix:**

<Chn> Channel number used to identify the active trace.

**Example:**

```
*RST; CALC:RIPP:DATA 1, 1500000000, 2000000000,
3
```

Define and enable a ripple limit range in the stimulus range between 1.5 GHz and 2 GHz, assigning a ripple limit of +3 dB.

```
CALC:RIPP:STAT ON; FAIL?
```

Switch the limit check on and query the result.

```
CALC:RIPP:STAT:AREA LEFT, TOP
```

For a subsequent check at the GUI or a hardcopy, move the info field to the top left position.

**Usage:** Query only

**Manual operation:** See "[Ripple Check](#)" on page 202

**CALCulate:RIPple:FAIL:ALL? [<RecallSet>]**

Returns a 0 or 1 to indicate whether or not the global ripple limit check has failed for at least one channel in the referenced recall set.

**Query parameters:**

<RecallSet> Recall set name; if omitted the active recall set is used

**Usage:** Query only

**Manual operation:** See "[Ripple Check](#)" on page 202

**CALCulate<Chn>:RIPple:RDOMain:FORMat <UnitRef>**

Deletes the existing ripple limit ranges and (re-)defines the physical unit of the ripple limit. The units of the stimulus values are defined via `CALCulate<Chn>:RIPple:CONTrol:DOMain`.

**Suffix:**

<Chn> Channel number used to identify the active trace.

**Setting parameters:**

<UnitRef> COMPlEx | MAGNitude | PHASe | REAL | IMAGinary | SWR | GDELay | L | C

Keyword for the physical unit of the response values; dimensionless numerals, relative power, phase, time, inductance, capacitance units.

\*RST: n/a

Default unit: 1 (U, for COMPlEx, REAL, IMAGinary, and SWR); dB (for MAGNitude), deg (for PHASe), s (for GDELay), H (Henry, for L), F (Farad, for C).

**Example:**

```
*RST; CALC:RIPP:DATA 1, 1500000000, 2000000000, 3
```

Define and enable a ripple limit range in the stimulus range between 1.5 GHz and 2 GHz, assigning a ripple limit of +3 dB.

```
CALC:RIPP:RDOM:FORM COMP
```

Delete the ripple limit range, select complex units for the ripple limit.

**Usage:**

Setting only

**CALCulate<Chn>:RIPple:SEGment:COUNT?**

Queries the number of ripple limit ranges. The response is an integer number.

**Suffix:**

<Chn> Channel number used to identify the active trace.

**Example:**

```
*RST; CALC:RIPP:DATA 1, 1500000000, 2000000000, 3, 1, 2000000000, 3000000000, 5
```

Define and enable a ripple limit range in the stimulus range between 1.5 GHz and 2 GHz, assigning a ripple limit of +3 dB. Define and enable a second ripple limit range in the stimulus range between 2 GHz and 3 GHz, assigning a ripple limit of +5 dB.

```
CALC:RIPP:SEGM:COUNT?
```

Query the number of ranges. The response is 2.

**Usage:**

Query only

**Manual operation:** See "[Range List](#)" on page 204

**CALCulate<Chn>:RIPple:SEGment<Seg>:LIMit <Limit>**

Defines the ripple limit for ripple limit range no. <Seg>. A range must be created first to enable this command (e.g. `CALCulate<Chn>:RIPple:DATA`). See [Chapter 3.4.1.2, "Rules for Ripple Test Definition"](#), on page 65.

**Tip:** To define several ripple limit ranges with a single command, use `CALCulate<Chn>:RIPple:DATA`.



<b>Suffix:</b>	
<Chn>	Channel number used to identify the active trace.
<Seg>	Number of the ripple limit range.
<b>Parameters:</b>	
<Limit>	Ripple limit in the range. The unit is adjusted to the format of the active trace ( <code>CALCulate&lt;Chn&gt;:FORMat</code> ).
	Range: Virtually no restriction for ripple limit ranges.
	*RST: n/a (no ripple limit line defined after a reset)
	Default unit: See above.
<b>Example:</b>	See <code>CALCulate&lt;Chn&gt;:RIPPlE:SEGMENT&lt;Seg&gt;:STIMulus:START</code>
<b>Manual operation:</b>	See "Range List" on page 204

---

### `CALCulate<Chn>:RIPPlE:SEGMENT<Seg>:RESult?`

Returns the result of the ripple limit check in the previously defined limit range no. <Seg>. The response consists of two parameters:

- <Boolean> – 0 for "passed", 1 for "failed".
- <Limit> – measured ripple in the limit range. A result is returned even if the limit check in the range no. <Seg> is disabled; see example below.

A reset deletes all ripple limit ranges. Use `CALCulate<Ch>:RIPPlE:FAIL?` to query the result for global ripple limit check.

**Note:** In remote control, the ripple limit check result is calculated once at the end of each sweep. If the ripple limits are changed, a new sweep is required to obtain updated ripple limit check results. In single sweep mode (`INITiate<Ch>:CONTinuous OFF`), the new sweep must be started explicitly. This behavior is different from manual control where a changed ripple limit line can directly affect the pass/fail result of the displayed trace.

<b>Suffix:</b>	
<Chn>	Channel number used to identify the active trace.
<Seg>	Number of the ripple limit range.
<b>Example:</b>	<pre>*RST; CALC:RIPP:DATA 1, 1500000000, 2000000000, 3 Define and enable a ripple limit range in the stimulus range between 1.5 GHz and 2 GHz, assigning a ripple limit of +3 dB. CALC:RIPP:STAT ON; SEGM:RES? Enable the limit check and query the result for the created range. Possible response: 0,0.3529814004. CALC:RIPP:DATA 0, 2500000000, 3000000000, 3 Define a second ripple limit range with disabled limit check (no limit check results are displayed in the diagram area). CALC:RIPP:SEGM2:RES? Query the result for the second range. Possible response: 0,1.149071925.</pre>

**Usage:** Query only

**Manual operation:** See ["Ripple Check"](#) on page 202

**CALCulate<Chn>:RIPple:SEGment<Seg>[:STATe] <Boolean>**

Enables or disables the limit check in the ripple limit range no. <Seg>.

**Suffix:**

<Chn> Channel number used to identify the active trace.

<Seg> Number of the ripple limit range.

**Parameters:**

<Boolean> ON | OFF - Limit check on or off. A result is available even if the limit check is disabled; see example for `CALCulate<Chn>:RIPple:SEGment<Seg>:RESult?`.

\*RST: n/a (no ripple limit line defined after a reset)

**Example:** See `CALCulate<Chn>:RIPple:SEGment<Seg>:STIMulus:START`

**Manual operation:** See ["Range List"](#) on page 204

**CALCulate<Chn>:RIPple:SEGment<Seg>:STIMulus:START <FreqPowTime>**

**CALCulate<Chn>:RIPple:SEGment<Seg>:STIMulus:STOP <FreqPowTime>**

These commands change the start or stop stimulus values (i.e. the smallest or largest stimulus values) of a ripple limit range. A range must be created first to enable these commands (e.g. `CALCulate<Chn>:RIPple:DATA`). See [Chapter 3.4.1.2, "Rules for Ripple Test Definition"](#), on page 65.

**Tip:** To define several ripple limit ranges with a single command, use `CALCulate<Chn>:RIPple:DATA`.

**Suffix:**

<Chn> Channel number used to identify the active trace.

<Seg> Number of the ripple limit range.

**Parameters:**

<FreqPowTime> Frequency, power or time value, according to the sweep type of the active channel (`[SENSe<Ch>:]SWEep:TYPE`).

Range: Virtually no restriction for ripple limit ranges.

\*RST: n/a (no ripple limit line defined after a reset)

Default unit: Hz for frequency sweeps, dBm for power sweeps, s for time and CW mode sweeps.

**Example:** `*RST; CALC:RIPP:DATA 1,1500000000, 2000000000,3`  
 Define and enable a ripple limit range in the stimulus range between 1.5 GHz and 2 GHz, assigning a ripple limit of +3 dB.  
`CALC:RIPP:SEGM:STIM:STAR 1GHZ; STOP 2.5 GHZ; :`  
`CALC:RIPP:SEGM:LIM 5`  
 Change the range to a stimulus range between 1 GHz and 2.5 GHz and a limit of 5 dB.  
`CALC:RIPP:SEGM:STAT OFF`  
 Disable the limit check in the modified stimulus range.

**Manual operation:** See "[Range List](#)" on page 204

#### **CALCulate<Chn>:RIPple:SOUNd[:STATe] <Boolean>**

Switches the acoustic signal (fail beep) on or off. The fail beep is generated each time the analyzer detects an exceeded ripple limit.

**Suffix:**

<Chn> Channel number used to identify the active trace.

**Parameters:**

<Boolean> ON | OFF - fail beep on or off.

\*RST: OFF

**Example:** `CALC:RIPP:STAT ON; SOUN ON`  
 Switch the limit check on and activate the fail beep.

**Manual operation:** See "[Ripple Fail Beep](#)" on page 203

#### **CALCulate<Chn>:RIPple:STATe <Boolean>**

Switches the ripple limit check for the active trace on or off.

**Tip:** Use `CALCulate<Chn>:RIPple:SEGment<Seg>[:STATe]` to switch the limit check for a single ripple limit range on or off.

**Suffix:**

<Chn> Channel number used to identify the active trace.

**Parameters:**

<Boolean> ON | OFF – ripple limit check on or off.

\*RST: OFF

**Example:** See `CALCulate<Chn>:RIPple:FAIL?`

**Manual operation:** See "[Ripple Check](#)" on page 202

#### **CALCulate<Chn>:RIPple:STATe:AREA <HorizontalPos>, <VerticalPos>**

Moves the ripple test info field for the active trace <Chn> to one of nine predefined positions in the active diagram.

<b>Suffix:</b>	
<Chn>	Channel number used to identify the active trace.
<b>Parameters:</b>	
<HorizontalPos>	LEFT   MID   RIGHT Horizontal position
<VerticalPos>	TOP   MID   BOTTOm Vertical position
<b>Example:</b>	See <a href="#">CALCulate&lt;Chn&gt;:RIPPlE:FAIL?</a>
<b>Manual operation:</b>	See " <a href="#">Ripple Check</a> " on page 202

---

#### **CALCulate<Chn>:RIPPlE:CLEAr**

Resets the limit check results for the ripple test.

<b>Suffix:</b>	
<Chn>	Channel number
<b>Usage:</b>	Event
<b>Manual operation:</b>	See " <a href="#">Clear Test</a> " on page 203

#### **6.3.2.13 CALCulate:SMOothing...**

The `CALCulate:SMOothing...` commands provide the settings for trace smoothing.

<a href="#">CALCulate&lt;Chn&gt;:SMOothing:APERture</a> .....	476
<a href="#">CALCulate&lt;Chn&gt;:SMOothing[:STATE]</a> .....	477

---

#### **CALCulate<Chn>:SMOothing:APERture <SmoothAperture>**

Defines how many measurement points are averaged to smooth the trace.

<b>Suffix:</b>	
<Chn>	Channel number used to identify the active trace.
<b>Parameters:</b>	
<SmoothAperture>	Smoothing aperture. A smoothing aperture of n % means that the smoothing interval for each sweep point i with stimulus value $x_i$ is equal to $[x_i - \text{span} \cdot n/200, x_i + \text{span} \cdot n/200]$ , and that the result of i is replaced by the arithmetic mean value of all measurement points in this interval. Range: 0.05% to 100%. *RST: 1 Default unit: %
<b>Example:</b>	*RST; :CALC:SMO ON Activate smoothing for the default trace. CALC:SMO:APER 0.5 Reduce the smoothing aperture to 0.5 %.

**Manual operation:** See "Aperture" on page 187

---

### **CALCulate<Chn>:SMOothing[:STATe] <Boolean>**

Enables or disables smoothing for trace no. <Chn>.

**Suffix:**

<Chn> Channel number used to identify the active trace.

**Parameters:**

<Boolean> ON | OFF - smoothing on or off.  
\*RST: OFF

**Example:** See `CALCulate<Chn>:SMOothing:APERture`

**Manual operation:** See "Smoothing" on page 187

### **6.3.2.14 CALCulate:STATistics...**

The `CALCulate:STATistics...` commands evaluate and display statistical and phase information of the trace.

<code>CALCulate&lt;Chn&gt;:STATistics:DOMain:USER</code> .....	477
<code>CALCulate&lt;Chn&gt;:STATistics:DOMain:USER:SHOW</code> .....	478
<code>CALCulate&lt;Chn&gt;:STATistics:DOMain:USER:START</code> .....	478
<code>CALCulate&lt;Chn&gt;:STATistics:DOMain:USER:STOP</code> .....	478
<code>CALCulate&lt;Chn&gt;:STATistics:EPDelay[:STATe]</code> .....	479
<code>CALCulate&lt;Chn&gt;:STATistics:MMPTpeak[:STATe]</code> .....	479
<code>CALCulate&lt;Chn&gt;:STATistics:MSTDdev[:STATe]</code> .....	479
<code>CALCulate&lt;Chn&gt;:STATistics:FORMat</code> .....	479
<code>CALCulate&lt;Chn&gt;:STATistics:NLINear:COMP:LEVel</code> .....	479
<code>CALCulate&lt;Chn&gt;:STATistics:NLINear:COMP:RESult?</code> .....	480
<code>CALCulate&lt;Chn&gt;:STATistics:NLINear:COMP[:STATe]</code> .....	480
<code>CALCulate&lt;Chn&gt;:STATistics:RESult?</code> .....	480
<code>CALCulate&lt;Chn&gt;:STATistics:RMS[:STATe]</code> .....	481
<code>CALCulate&lt;Chn&gt;:STATistics:SFLatness[:STATe]</code> .....	481
<code>CALCulate&lt;Chn&gt;:STATistics[:STATe]</code> .....	482
<code>CALCulate&lt;Chn&gt;:STATistics[:STATe]:AREA</code> .....	482

---

### **CALCulate<Chn>:STATistics:DOMain:USER <EvalRange>**

Selects one out of 10 evaluation ranges to be configured with the `CALCulate<Chn>:STATistics:DOMain:USER:SHOW`, `CALCulate<Chn>:STATistics:DOMain:USER:START`, and `CALCulate<Chn>:STATistics:DOMain:USER:STOP` commands.

**Suffix:**

<Chn> Channel number used to identify the active trace.

**Parameters:**

**<EvalRange>** Number of the evaluation range.  
 Range: 1 to 10. In addition, 0 denotes the (non-configurable) "Full Span" evaluation range.  
 \*RST: 0

**Example:**

```
*RST; :CALC:STAT:DOM:USER?
Query the default evaluation range. The response is zero, i.e.
the evaluation range is equal to the complete sweep range
CALC:STAT:DOM:USER 1
CALC:STAT:DOM:USER:START 1GHZ; STOP 2GHZ; SHOW
ON
Select evaluation range no. 1 and define the evaluation range
between 1 GHz and 2 GHz. Display the range limit lines.
```

**Manual operation:** See ["Evaluation Range"](#) on page 186

**CALCulate<Chn>:STATistics:DOMain:USER:SHOW <Boolean>**

Displays or hides range limit lines for the evaluation range selected via [CALCulate<Chn>:STATistics:DOMain:USER](#).

**Suffix:**

**<Chn>** Channel number used to identify the active trace.

**Parameters:**

**<Boolean>** ON | OFF - range limit lines on or off.  
 \*RST: OFF

**Example:** See [CALCulate<Chn>:STATistics:DOMain:USER](#)

**Manual operation:** See ["Range Limit Lines on"](#) on page 186

**CALCulate<Chn>:STATistics:DOMain:USER:START <Start>****CALCulate<Chn>:STATistics:DOMain:USER:STOP <Stop>**

These commands define the start and stop values of the evaluation range selected via [CALCulate<Chn>:STATistics:DOMain:USER](#).

**Suffix:**

**<Chn>** Channel number used to identify the active trace.

**Parameters:**

**<Stop>** Start or stop value of the evaluation range.  
 Default unit: NN

**Example:** See [CALCulate<Chn>:STATistics:DOMain:USER](#)

**Manual operation:** See ["Evaluation Range"](#) on page 186

**CALCulate<Chn>:STATistics:EPDelay[:STATe]** <Boolean>  
**CALCulate<Chn>:STATistics:MMPTpeak[:STATe]** <Boolean>  
**CALCulate<Chn>:STATistics:MSTDdev[:STATe]** <Boolean>

These commands display or hide the "Phase/EI Length" results, the "Min/Max/Peak-Peak" results, and the "Mean/Std Dev" results in the diagram area of trace no. <Chn>.

**Suffix:**

<Chn> Channel number used to identify the active trace.

**Parameters:**

<Boolean> ON | OFF - statistical info field on or off.  
 \*RST: OFF

**Example:** See [CALCulate<Chn>:STATistics\[:STATe\]](#)

**Manual operation:** See "[Statistical Functions](#)" on page 182

**CALCulate<Chn>:STATistics:FORMat** <Format>

For complex-valued traces (Smith, Polar) this determines how the MEAN, STDDev, MAX, MIN, RMS and PTPeak statistics are calculated, see [CALCulate<Chn>:STATistics:RESult?](#).

**Suffix:**

<Chn> Channel number

**Parameters:**

<Format> ZVAB | IMPedance | ADMittance  
 ZVAB: the results are based on unformatted wave quantities (voltages)  
 IMPedance: the results are based on resistance values  
 ADMittance: the results are based on conductance values

**Manual operation:** See "[Format](#)" on page 183

**CALCulate<Chn>:STATistics:NLINear:COMP:LEVel** <Stop>

Defines the compression value x for the compression point measurement ([CALCulate<Chn>:STATistics:NLINear:COMP:RESult?](#)).

**Suffix:**

<Chn> Channel number used to identify the active trace.

**Parameters:**

<Stop> Stop value of the evaluation range.  
 Range: +0.01 dBm to +100.00 dBm  
 \*RST: 1 dBm  
 Default unit: dB

**Example:** See [CALCulate<Chn>:STATistics:NLINear:COMP:RESult?](#)

**Manual operation:** See "[Compr Point / Value](#)" on page 184

**CALCulate<Chn>:STATistics:NLINear:COMP:RESult?**

Returns the x-dB compression point of an S-parameter or ratio measured in a power sweep. The compression value x is set via `CALCulate<Chn>:STATistics:NLINear:COMP:LEVel`.

The response contains two numeric values:

- <Cmp In> – stimulus level at the compression point in dBm.
- <Cmp Out> – sum of <Cmp In> plus the magnitude of the measured response value at the compression point in dBm.

**Suffix:**

<Chn> Channel number used to identify the active trace.

**Example:**

```
*RST; SWE:TYPE POW
```

Select a power sweep with default CW frequency and sweep range.

```
CALC:STAT:NLIN:COMP:LEV 2
```

Define a compression value of 2 dB.

```
CALC:STAT:NLIN:COMP:RES?
```

Query the compression point results <Cmp In>, <Cmp Out>. An execution error message (error no. -200) is returned if no compression point is found.

```
CALC:STAT:NLIN:COMP ON
```

Display the compression point result in the diagram area.

**Usage:** Query only

**Manual operation:** See "[Compr Point / Value](#)" on page 184

**CALCulate<Chn>:STATistics:NLINear:COMP[:STATe] <Boolean>**

Displays or hides the compression point result in the diagram area of trace no. <Chn>.

**Suffix:**

<Chn> Channel number used to identify the active trace.

**Parameters:**

<Boolean> ON | OFF - statistical info field on or off.

```
*RST: OFF
```

**Example:** See `CALCulate<Chn>:STATistics:NLINear:COMP:RESult?`

**Manual operation:** See "[Compr Point / Value](#)" on page 184

**CALCulate<Chn>:STATistics:RESult? <Result>**

Returns a single statistical parameter of the trace no. <Chn> or all parameters. It is not necessary to display the info field (`CALCulate<Chn>:STATistics[:STATe]ON`) before using this command.



**Suffix:**

<Chn> Channel number used to identify the active trace.

**Query parameters:**

<Result> MEAN | STDDDev | MAX | MIN | RMS | PTPeak | PEAK2p | ELENgth | PDELay | GAIN | SLOPe | FLATness | ALL

MEAN - return arithmetic mean value of all response values of the trace in the entire sweep range (or in the evaluation range defined in manual control).

STDDDev - return standard deviation of all response values.

MAX - return the maximum of all response values.

MIN - return the minimum of all response values.

RMS - return the root mean square of all response values.

PTPeak - return the peak-to-peak value (MAX - MIN).

ELENgth - return the electrical length.

PDELay - return the phase delay.

GAIN - return the gain, i.e. the larger of two marker values.

SLOPe - return the slope (difference) between two marker values.

FLATness - return the flatness of the trace between two marker positions.

ALL - return all statistical values, observing the order used above.

The data is returned as a comma-separated list of real numbers. The unit is the default unit of the measured parameter (see [CALCulate<Ch>:PARAmeter:SDEFine](#)) but may also depend on the trace format (see [CALCulate<Chn>:FORMat](#)). For complex traces the statistical results MEAN, STDDDev, MAX, MIN, RMS and PTPeak are calculated in the selected format (see [CALCulate<Chn>:STATistics:FORMat](#)).

**Example:**

```
*RST; :CALC:STAT:RES? MAX
```

Calculate and return the maximum of the default trace showing an S-parameter on a dB Mag scale.

```
:CALC:FORM POL; STAT:RES? MAX
```

Display the trace in a polar diagram and re-calculate the maximum. The result corresponds to the previous result but is converted to a unitless linear value.

**Usage:**

Query only

**Manual operation:** See "[Statistical Functions](#)" on page 182

---

**CALCulate<Chn>:STATistics:RMS[:STATe]** <Boolean>

**CALCulate<Chn>:STATistics:SFLatness[:STATe]** <Boolean>

These commands display or hide the "RMS" and the "Flatness/Gain/Slope" results in the diagram area of trace no. <Chn>.

**Suffix:**

<Chn> Channel number used to identify the active trace.

**Parameters:**

<Boolean> ON | OFF - statistical info field on or off.  
 \*RST: OFF

**Example:** See `CALCulate<Chn>:STATistics[:STATe]`

**Manual operation:** See "Flatness / Gain / Slope" on page 184

**CALCulate<Chn>:STATistics[:STATe] <Boolean>**

Displays or hides all statistical results in the diagram area of trace no. <Chn> except the compression point results.

**Tip:** You can display or hide the "Min/Max/Peak-Peak", "Mean/Std Dev/RMS", "Phase/EI Length" and "Flatness/Gain/Slope" results separately; see example below.

**Suffix:**

<Chn> Channel number used to identify the active trace.

**Parameters:**

<Boolean> ON | OFF - Statistical info field on or off.  
 \*RST: OFF

**Example:**

```
*RST; :CALC:STAT:MMPT ON
```

Reset the instrument, hiding all statistical results. Display the "Min/Max/Peak-Peak" results.

```
CALC:STAT:MSTD ON
```

Display the "Mean/Std Dev" results in addition.

```
CALC:STAT:RMS ON
```

Display the "RMS" results in addition.

```
CALC:STAT:EPD ON
```

Display the "Phase/EI Length" results in addition.

```
CALC:STAT:SFL ON
```

Display the "Flatness/Gain/Slope" results in addition.

```
CALC:STAT:STAT:AREA LEFT, TOP
```

For a subsequent check at the GUI or a hardcopy, move the info field to the top left position.

```
...
```

```
CALC:STAT OFF
```

Hide all results.

**Manual operation:** See "Statistical Functions" on page 182

**CALCulate<Chn>:STATistics[:STATe]:AREA <HorizontalPos>, <VerticalPos>**

Moves the statistics info field for the active trace <Chn> to one of nine predefined positions in the active diagram.

**Suffix:**

<Chn> Channel number used to identify the active trace.

**Parameters:**

<HorizontalPos>	LEFT   MID   RIGHT Horizontal position
<VerticalPos>	TOP   MID   BOTTOm Vertical position

**Example:** See `CALCulate<Chn>:STATistics[:STATe]`

**Manual operation:** See "Compr Point / Value" on page 184

**6.3.2.15 CALCulate:TRANSform...**

The `CALCulate:TRANSform...` commands convert measured data from one representation to another and control the transformation into the time domain (with option R&S ZNC/ZND-K2).

<code>CALCulate&lt;Chn&gt;:TRANSform:COMPLex</code> .....	483
<code>CALCulate&lt;Chn&gt;:TRANSform:IMPedance:RNORmal</code> .....	484
<code>CALCulate&lt;Chn&gt;:TRANSform:TIME:CENTer</code> .....	484
<code>CALCulate&lt;Chn&gt;:TRANSform:TIME:DCHebyshev</code> .....	485
<code>CALCulate&lt;Chn&gt;:TRANSform:TIME:LPASs</code> .....	485
<code>CALCulate&lt;Chn&gt;:TRANSform:TIME:LPASs:DCSParam</code> .....	486
<code>CALCulate&lt;Chn&gt;:TRANSform:TIME:LPASs:DCSParam:CONTInuous</code> .....	486
<code>CALCulate&lt;Chn&gt;:TRANSform:TIME:LPASs:DCSParam:EXTRapolate</code> .....	487
<code>CALCulate&lt;Chn&gt;:TRANSform:TIME:LPFRequency</code> .....	487
<code>CALCulate&lt;Chn&gt;:TRANSform:TIME:RESolution:EFACtor</code> .....	487
<code>CALCulate&lt;Chn&gt;:TRANSform:TIME:SPAN</code> .....	488
<code>CALCulate&lt;Chn&gt;:TRANSform:TIME:START</code> .....	488
<code>CALCulate&lt;Chn&gt;:TRANSform:TIME:STATe</code> .....	489
<code>CALCulate&lt;Chn&gt;:TRANSform:TIME:STIMulus</code> .....	489
<code>CALCulate&lt;Chn&gt;:TRANSform:TIME:STOP</code> .....	489
<code>CALCulate&lt;Chn&gt;:TRANSform:TIME[:TYPE]</code> .....	490
<code>CALCulate&lt;Chn&gt;:TRANSform:TIME:WINDow</code> .....	490
<code>CALCulate&lt;Chn&gt;:TRANSform:TIME:XAXis</code> .....	491
<code>CALCulate&lt;Ch&gt;:TRANSform:VNETworks:FSIMulator[:STATe]</code> .....	491

**CALCulate<Chn>:TRANSform:COMPLex <Result>**

Converts S-parameters into converted (matched-circuit) Y-parameters or Z-parameters and vice versa, assuming that port no.  $i$  is terminated with  $Z_{0i}$  so that the three parameter sets are equivalent and the following formulas apply:

$$Z_{ii} = Z_{0i} \frac{1 + S_{ii}}{1 - S_{ii}}$$

$$Z_{ij} = 2 \cdot \frac{\sqrt{Z_{0i} \cdot Z_{0j}}}{S_{ij}} - (Z_{0i} + Z_{0j}), \quad i \neq j,$$

$$Y_{ii} = \frac{1}{Z_{0i}} \frac{1 - S_{ii}}{1 + S_{ii}} = 1/Z_{ii}$$

$$Y_{ij} = \frac{S_{ij}}{2 \cdot \sqrt{Z_{0i} \cdot Z_{0j}} - S_{ij} \cdot (Z_{0i} + Z_{0j})} = 1/Z_{ij}, \quad i \neq j, \quad i, j = 1, \dots, 99$$

**Suffix:**

<Chn> Channel number used to identify the active trace.

**Parameters:**

<Result> S | Y | Z  
S-parameters, Y-parameters, Z-parameters

**Example:**

```
*RST; CALC:PAR:MEAS 'Trc1', 'Y-S22'
```

Select the converted admittance Y <-- S22 as measurement parameter of the default trace.

```
CALC:TRAN:COMP S
```

Convert the converted Y-parameter into an S-parameter.

**CALCulate<Chn>:TRANSform:IMPedance:RNORmal <Model>**

Selects the theory for the renormalization of port impedances. The selection has an impact on the conversion formulas for wave quantities and S-parameters.

**Suffix:**

<Chn> Channel number used to identify the active trace.

**Parameters:**

<Model> TWAVes | PWAVes  
TWAVes - travelling waves  
PWAVes - power waves  
\*RST: TWAVes

**Example:** See [\[SENSe<Ch>:\] PORT<PhyPt>: ZREFerence](#)

**Manual operation:** See ["Renormalization according to Theory of"](#) on page 136

**CALCulate<Chn>:TRANSform:TIME:CENTer <CenterTime>**

Defines the center time of the diagram in time domain.

**Suffix:**

<Chn> Channel number used to identify the active trace.

**Parameters:**

<CenterTime> Center time of the diagram in time domain.  
Range: -99.9999999999 s to +99.9999999999 s  
Increment: 0.1 ns  
\*RST: 1.5E-009 s  
Default unit: s

**Example:** `*RST; :CALC:TRAN:TIME:STAT ON`  
 Reset the instrument, activating a frequency sweep, and enable the time domain transformation for the default trace.  
`CALC:TRAN:TIME:CENT 0; SPAN 5ns`  
 Set the center time to 0 ns and the time span to 5 ns.

**Manual operation:** See ["Time Start / Stop / Center / Span"](#) on page 232

**Note:** If the x-axis is scaled in distance units (`CALCulate<Chn>:TRANSform:TIME:XAXisDISTance`), then the center value is entered in m; the range and default value changes accordingly.

### `CALCulate<Chn>:TRANSform:TIME:DCHebshev <SidebandSupp>`

Sets the sideband suppression for the Dolph-Chebyshev window. The command is only available if a Dolph-Chebyshev window is active (`CALCulate<Chn>:TRANSform:TIME:WINDowDCHebshev`).

**Suffix:**  
`<Chn>` Channel number used to identify the active trace.

**Parameters:**  
`<SidebandSupp>` Sideband suppression  
 Range: 10 dB to 120 dB  
 Increment: 10 dB  
 \*RST: 32 dB  
 Default unit: dB

**Example:** `*RST; :CALC:TRAN:TIME:WIND DCH`  
 Reset the instrument and select a Dolph-Chebyshev window for filtering the data in the frequency domain.  
`CALC:TRAN:TIME:DCH 25`  
 Set the sideband suppression to 25 dB.

**Manual operation:** See ["Side Lobe Level"](#) on page 177

### `CALCulate<Chn>:TRANSform:TIME:LPASs <Algorithm>`

Calculates the harmonic grid for low pass time domain transforms according to one of the three alternative algorithms.

**Suffix:**  
`<Chn>` Channel number used to identify the active trace.

**Parameters:**  
`<Algorithm>` KFSTop | KDFrequency | KSDFrequency  
 KFSTop - keep stop frequency and number of points  
 KDFrequency - keep frequency gap and number of points  
 KSDfrequency - keep stop frequency and approximate frequency gap

**Example:** See `CALCulate<Chn>:TRANSform:TIME[:TYPE]`

**Manual operation:** See "Set Harmonic Grid and Keep" on page 178

---

### **CALCulate<Chn>:TRANSform:TIME:LPASs:DCSParm <DCValue>**

Defines the DC value for low pass transforms. The command is enabled only if the sweep points are on a harmonic grid (to be set explicitly or using `CALCulate<Chn>:TRANSform:TIME:LPASs`).

**Suffix:**

<Chn> Channel number used to identify the active trace.

**Parameters:**

<DCValue> DC value of the measured quantity  
 Range: Depending on the measured quantity (-1 to +1 for S-parameters)  
 \*RST: 0

**Example:**

```
*RST; :CALC:TRAN:TIME:STAT ON
```

Reset the instrument, activating a frequency sweep with  $S_{21}$  as measured quantity, and enable the time domain transformation for the default trace.

```
CALC:TRAN:TIME LPAS; TIME:STIM STEP
```

Select a low pass step transformation.

```
CALC:TRAN:TIME:LPAS KFST
```

Calculate a harmonic grid, maintaining the stop frequency and the number of points.

```
CALC:TRAN:TIME:LPAS:DCSP 0.2
```

Set the DC value.

```
CALC:TRAN:TIME:LPAS:DCSP:EXTR; :CALC:TRAN:TIME:LPAS:DCSP?
```

Extrapolate the measured trace, overwrite the defined DC value, and query the new value.

```
CALC:TRAN:TIME:LPAS:DCSP:CONT ON
```

Switch over to continuous extrapolation (e.g. because you noticed a discrepancy between the manually entered DC value and the extrapolation and assume the extrapolation to be more trustworthy).

```
CALC:TRAN:TIME:RES:EFAC 3
```

Select a resolution enhancement factor of 3 in order to improve the resolution in time domain.

**Manual operation:** See "DC Value" on page 178

---

### **CALCulate<Chn>:TRANSform:TIME:LPASs:DCSParm:CONTinuous <Boolean>**

Determines whether continuous extrapolation for the DC value is enabled.

**Suffix:**

<Chn> Channel number used to identify the active trace.

**Parameters:**

<Boolean> ON - continuous extrapolation enabled  
 OFF - continuous extrapolation disabled  
 \*RST: OFF

**Example:** See `CALCulate<Chn>:TRANSform:TIME:LPASs:DCSParam`

**Manual operation:** See "DC Value" on page 178

**CALCulate<Chn>:TRANSform:TIME:LPASs:DCSParam:EXTRapolate**

Extrapolates the measured trace towards  $f = 0$  and overwrites the current DC value (`CALCulate<Chn>:TRANSform:TIME:LPASs:DCSParam`). The command is relevant for low pass time domain transforms.

**Suffix:**

<Chn> Channel number used to identify the active trace.

**Example:** See `CALCulate<Chn>:TRANSform:TIME:LPASs:DCSParam`

**Usage:** Event

**Manual operation:** See "DC Value" on page 178

**CALCulate<Chn>:TRANSform:TIME:LPFRequency**

Calculates the harmonic grid for low pass time domain transforms, keeping the stop frequency and the number of points.

**Tip:** Use `CALCulate<Chn>:TRANSform:TIME:LPASs` if you wish to use one of the other algorithms for calculating the grid.

**Suffix:**

<Chn> Channel number used to identify the active trace.

**Example:** See `CALCulate<Chn>:TRANSform:TIME[:TYPE]`

**Usage:** Event

**Manual operation:** See "DC Value" on page 178

**CALCulate<Chn>:TRANSform:TIME:RESolution:EFACtor <REfactor>**

Defines the resolution enhancement factor for the time domain transform.

**Suffix:**

<Chn> Channel number used to identify the active trace.

**Parameters:**

<REfactor> Resolution enhancement factor.  
 Range: 1 to 10.  
 Increment: 0.1  
 \*RST: 1 (no resolution enhancement)

**Example:** See `CALCulate<Chn>:TRANSform:TIME:LPASs:DCSParam`

**Manual operation:** See ["Resolution Enh\(ancement\)"](#) on page 177

---

### **CALCulate<Chn>:TRANSform:TIME:SPAN <Span>**

Defines the time span of the diagram in time domain.

**Suffix:**

<Chn> Channel number used to identify the active trace.

**Parameters:**

<Span> Time span of the diagram in time domain.  
 Range: 2E-012 s to 200 s.  
 Increment: 0.1 ns  
 \*RST: 5E-009 s  
 Default unit: s

**Example:** See [CALCulate<Chn>:TRANSform:TIME:CENTer](#)

**Manual operation:** See ["Time Start / Stop / Center / Span"](#) on page 232

**Note:** If the x-axis is scaled in distance units ([CALCulate<Chn>:TRANSform:TIME:XAXisDISTance](#)), then the span is entered in m; the range and default value changes accordingly.

---

### **CALCulate<Chn>:TRANSform:TIME:START <StartTime>**

Defines the start time of the diagram in time domain.

**Suffix:**

<Chn> Channel number used to identify the active trace.

**Parameters:**

<StartTime> Start time of the diagram.  
 Range: -100 s to +99.9999999999998 s.  
 Increment: 0.1 ns  
 \*RST: -1E-009 s  
 Default unit: s

**Example:** \*RST; :CALC:TRAN:TIME:STAT ON  
 Reset the instrument, activating a frequency sweep, and enable the time domain transformation for the default trace.  
 CALC:TRAN:TIME:STAR 0; STOP 10 ns  
 Set the start time to 0 ns and the stop time to 10 ns.

**Manual operation:** See ["Time Start / Stop / Center / Span"](#) on page 232

**Note:** If the start frequency entered is greater than the current stop frequency ([CALCulate<Chn>:TRANSform:TIME:STOP](#)), the stop frequency is set to the start frequency plus the minimum frequency span ([CALCulate<Chn>:TRANSform:TIME:SPAN](#)). If the x-axis is scaled in distance units ([CALCulate<Chn>:TRANSform:TIME:XAXisDISTance](#)), then the start value is entered in m; the range and default value changes accordingly.



**CALCulate<Chn>:TRANSform:TIME:STATe** <Boolean>

Determines whether the time domain transformation for trace no. <Chn> is enabled.

**Suffix:**

<Chn> Channel number used to identify the active trace.

**Parameters:**

<Boolean> ON - time domain representation active.  
OFF - frequency domain representation active.

\*RST: OFF

**Example:**

\*RST; :CALC:TRAN:TIME:STAT?

Reset the instrument, activating a frequency sweep, and query whether the default trace is displayed in the time domain. The response is 0.

**Manual operation:** See ["Time Domain"](#) on page 176

**CALCulate<Chn>:TRANSform:TIME:STIMulus** <Type>

Selects the type of stimulus to be simulated in the low pass transformation process.

**Suffix:**

<Chn> Channel number used to identify the active trace.

**Parameters:**

<Type> IMPulse | STEP  
IMPulse - impulse response, in bandpass or lowpass mode.  
STEP - step response, only in lowpass mode (a bandpass mode setting `CALCulate<Chn>:TRANSform:TIME[:TYPE]BPASs` is automatically changed to lowpass).

\*RST: IMP

**Example:**

See `CALCulate<Chn>:TRANSform:TIME[:TYPE]`

**Manual operation:** See ["Type"](#) on page 176

**CALCulate<Chn>:TRANSform:TIME:STOP** <StopTime>

Defines the stop time of the diagram in time domain.

**Suffix:**

<Chn> Channel number used to identify the active trace.

**Parameters:**

<StopTime> Stop time of the diagram.  
Range: -99.999999999998 s to +100 s.  
Increment: 0.1 ns  
\*RST: +4E-009 s  
Default unit: s

**Example:**

See `CALCulate<Chn>:TRANSform:TIME:START`

**Manual operation:** See ["Time Start / Stop / Center / Span"](#) on page 232

Note: If the stop frequency entered is smaller than the current start frequency (`CALCulate<Chn>:TRANSform:TIME:START`), the start frequency is set to the stop frequency minus the minimum frequency span (`CALCulate<Chn>:TRANSform:TIME:SPAN`). If the x-axis is scaled in distance units (`CALCulate<Chn>:TRANSform:TIME:XAXisDISTance`), then the stop value is entered in m; the range and default value changes accordingly.

---

### `CALCulate<Chn>:TRANSform:TIME[:TYPE] <TransformType>`

Selects the time domain transformation type.

**Suffix:**

<Chn> Channel number used to identify the active trace.

**Parameters:**

<TransformType> BPASs | LPASs  
 BPASs - band pass impulse (only impulse response; a step response `CALCulate<Chn>:TRANSform:TIME:STIMulusSTEP` is automatically changed to impulse response)  
 LPASs - low pass (impulse or step response, depending on `CALCulate<Chn>:TRANSform:TIME:STIMulus` setting)  
 \*RST: BPASs

**Example:**

```
*RST; :CALC:TRAN:TIME:STAT ON
Reset the instrument, activating a frequency sweep, and enable
the time domain transformation for the default trace.
CALC:TRAN:TIME LPAS; TIME:STIM STEP
Select a low pass step transformation.
CALC:TRAN:TIME:LPAS KFST
Calculate a harmonic grid, keeping the stop frequency and the
number of points.
```

**Manual operation:** See ["Type"](#) on page 176

---

### `CALCulate<Chn>:TRANSform:TIME:WINDow <WindowType>`

Selects the window type for filtering the data in the frequency domain prior to the time domain transformation.

**Suffix:**

<Chn> Channel number used to identify the active trace.

**Parameters:**

<WindowType> RECT | HAMMING | HANNING | BOHMAN | DCHEBYSHEV  
 RECT - no profiling (rectangle)  
 HANN - normal profile (Hann)  
 HAMMING - low first sidelobe (Hamming)  
 BOHMAN - steep falloff (Bohman)  
 DCHEBYSHEV - arbitrary sidelobes (Dolph-Chebyshev)  
 \*RST: HANN

**Example:**

See `CALCulate<Chn>:TRANSform:TIME:DCHEBYSHEV`

**Manual operation:**

See "[Impulse Response](#)" on page 176

**CALCulate<Chn>:TRANSform:TIME:XAXis <Unit>**

Switches over between the x-axis scaling in time units or distance units.

**Suffix:**

<Chn> Channel number used to identify the active trace.

**Parameters:**

<Unit> TIME | DISTANCE  
 TIME - x-axis scaled in time units.  
 DISTANCE - x-axis scaled in distance units (Distance = Time \*  $c_0$  \* Velocity Factor).

**Example:**

\*RST; :CALC:TRAN:TIME:STAT ON  
 Reset the instrument, activating a frequency sweep, and enable the time domain transformation for the default trace.  
 CALC:TRAN:TIME:XAX DIST  
 Convert the x-axis scaling to distance units.

**Manual operation:**

See "[Time / Distance](#)" on page 232

**CALCulate<Ch>:TRANSform:VNETworks:FSIMulator[:STATe] <Enable>****Suffix:**

<Ch> Channel number

**Parameters:**

<Enable>

**Manual operation:**

See "[Fixture Simulator](#)" on page 298

### 6.3.3 CONFigure Commands

The `CONFigure...` commands create and delete channels or traces and assign channel and trace names. The commands are device-specific.

CONFigure:CHANnel:CATalog?.....	492
CONFigure:CHANnel:MEASure:ALL[:STATe].....	492
CONFigure:CHANnel<Ch>:MEASure[:STATe].....	493
CONFigure:CHANnel<Ch>:NAME.....	493
CONFigure:CHANnel<Ch>:NAME:ID?.....	493
CONFigure:CHANnel<Ch>[:STATe].....	494
CONFigure:CHANnel<Ch>:TRACe:CATalog?.....	494
CONFigure:CHANnel<Ch>:TRACe:REName.....	495
CONFigure:TRACe:CATalog?.....	495
CONFigure:TRACe<Trc>:CHANnel:NAME?.....	496
CONFigure:TRACe<Trc>:CHANnel:NAME:ID?.....	496
CONFigure:TRACe<Trc>:NAME.....	497
CONFigure:TRACe<Trc>:NAME:ID?.....	497
CONFigure:TRACe<Trc>:REName.....	497
CONFigure:TRACe:WINDow?.....	498
CONFigure:TRACe:WINDow:TRACe?.....	498

---

### CONFigure:CHANnel:CATalog?

Returns the numbers and names of all channels in the current recall set. The response is a string containing a comma-separated list of channel numbers and names; see example below. If all channels have been deleted the response is an empty string ("").

**Example:**

```
*RST; :CONF:CHAN2:STAT ON; NAME 'New Channel'
```

Create channel 2 and assign the channel name "New Channel".

```
CONF:CHAN:CAT?
```

Query all channels and their names. As a default channel no. 1 is created on \*RST, the response is

```
'1,Ch1,2,New_Channel'
```

```
CONF:CHAN:NAME:ID? 'New Channel'
```

Query the channel number for the channel named "New Channel". The response is 2.

**Usage:** Query only

**Manual operation:** See "[Channel table](#)" on page 299

---

### CONFigure:CHANnel:MEASure:ALL[:STATe] <Boolean>

Enables or disables the sweep in all channels of the active recall set. This command can be used in combination with `CONFigure:CHANnel<Ch>:MEASure[:STATe]` to optimize the measurement speed.

**Parameters:**

<Boolean> ON | OFF  
 \*RST: ON

**Example:** See `CONFigure:CHANnel<Ch>:MEASure[:STATe]`

**Manual operation:** See "[Continuous / Single](#)" on page 249

**CONFigure:CHANnel<Ch>:MEASure[:STATe] <Boolean>**

Enables or disables the sweep in channel no. <Ch>. This command can be used to restrict the measurement in a subset of channels in order to optimize the measurement speed.

**Suffix:**

<Ch>                      Number of an existing channel.

**Parameters:**

<Boolean>                ON | OFF  
 \*RST:                    ON (all existing channels)

**Example:**

```
*RST; :CONFigure:CHANnel2 ON; CHANnel3 ON
Create channels 2 and 3, in addition to the default channel no.
1. The analyzer performs sweeps in all three channels.
CONFigure:CHANnel:MEASure:ALL OFF
Disable the measurement in all channels
CONFigure:CHANnel2:MEASure ON
(Re-)enable the measurement in channel no. 2. The analyzer
measures in channel 2; the channels no. 1 and 3 are not mea-
sured.
```

**Manual operation:** See "[Continuous / Single](#)" on page 249

**CONFigure:CHANnel<Ch>:NAME <ChannelName>**

Assigns a name to channel number <Ch>. The channel must be created before ([CONFigure:CHANnel<Ch>\[:STATe\] ON](#)). Moreover it is not possible to assign the same name to two different channels. [CONFigure:CHANnel:CATalog?](#) returns a list of all defined channels with their names.

**Suffix:**

<Ch>                      Number of an existing channel.

**Parameters:**

<ChannelName>          Channel name, e.g. 'Channel 4'.  
 \*RST:                    'Ch1'

**Example:** See [CONFigure:CHANnel:CATalog?](#)

**Manual operation:** See "[Trace Manager Table](#)" on page 165

**CONFigure:CHANnel<Ch>:NAME:ID? <ChannelName>**

Queries the channel number (numeric suffix) of a channel with known channel name. A channel name must be assigned before ([CONFigure:CHANnel<Ch>:NAME '<ChannelName>'](#)). [CONFigure:CHANnel:CATalog?](#) returns a list of all defined channels with their names.

**Suffix:**

<Ch>                      Channel number. This suffix is not relevant and may be omitted (the command returns the actual channel number).

**Query parameters:**

<ChannelName> Channel name, e.g. 'Channel 4'.

**Example:** See [CONFigure:CHANnel:CATalog?](#)

**Usage:** Query only

**Manual operation:** See "[Trace Manager Table](#)" on page 165

**CONFigure:CHANnel<Ch>[:STATe] <Boolean>**

Creates or deletes channel no. <Ch> and selects it as the active channel.

[CONFigure:CHANnel<Ch>:NAME](#) defines the channel name.

A channel created with [CONFigure:CHANnel<Ch>\[:STATe\] ON](#) can be configured but has no trace assigned so that no measurement can be initiated. Use [CALCulate<Ch>:PARAMeter:SDEFine](#)"<TraceName>,"<Parameter>" to create a new channel and a new trace. In remote control it is possible to remove all channels. This is in contrast to manual control where at least one channel with one diagram area and one trace must be available.

**Suffix:**

<Ch> Number of the channel to be created or deleted.

**Parameters:**

<Boolean> ON - create channel no. <Ch>. If the channel no. <Ch> exists already, it is not modified but selected as the active channel.  
OFF - delete channel no. <Ch>.

\*RST: ON for channel no. 1 (created on \*RST), OFF for all other channels.

**Example:** See [CONFigure:CHANnel:CATalog?](#)

**Manual operation:** See "[Add Ch + Trace](#)" on page 297

**CONFigure:CHANnel<Ch>:TRACe:CATalog?**

Returns the numbers and names of all traces in channel no. <Ch>. The response is a string containing a comma-separated list of trace numbers and names; see example. If all traces have been deleted the response is an empty string ("").

**Tip:** Use [CONFigure:TRACe:CATalog?](#) to query the traces in all channels of the active recall set.

**Suffix:**

<Ch> Channel number

**Example:** See [CONFigure:TRACe:CATalog?](#)

**Usage:** Query only

**Manual operation:** See "[Trace Manager Table](#)" on page 165

**CONFigure:CHANnel<Ch>:TRACe:REName <TraceName>**

Assigns a (new) name to the active trace in channel <Ch>.

**Suffix:**

<Ch> Channel number

**Setting parameters:**

<TraceName> Trace name, e.g. 'Trace 4'.

**Example:**

```
*RST; :CONF:CHAN:TRAC:REN 'Testtrace_1'
```

Reset the analyzer to create a default trace in channel 1 and set this trace as the active trace. Rename the trace 'Testtrace\_1'.

```
CALC:PAR:SDEF 'Testtrace_2', 'S11'
```

Create a new trace which will become the active trace in channel no. 1.

```
CONF:TRAC:REN 'Testtrace_1', 'Testtrace_3'
```

Rename the first trace (which is currently not active) 'Testtrace\_3'.

**Usage:** Setting only

**Manual operation:** See "[Trace Manager Table](#)" on page 165

**CONFigure:TRACe:CATalog?**

Returns the numbers and names of all traces in the current recall set. The response is a string containing a comma-separated list of trace numbers and names, see example below. If all traces have been deleted the response is an empty string ("").

**Tip:** Use `CONFigure:CHANnel<Ch>:TRACe:CATalog?` to query the traces in a particular channel; see example.

**Example:**            \*RST; :CALC2:PAR:SDEF 'Ch2Trc2', 'S11'  
                          Create channel 2 and a new trace named Ch2Trc2.  
                          CONF:TRAC:CAT?  
                          Query all traces and their names. As a default trace no. 1 is created upon \*RST, the response is '1,Trc1,2,Ch2Trc2'.  
                          CONF:CHAN1:TRAC:CAT?  
                          Query the channels in channel no. 1. The response is '1,Trc1'.  
                          CONF:TRAC:NAME:ID? 'Ch2Trc2'  
                          Query the trace number for the trace named "Ch2Trc2". The response is 2.  
                          CONF:TRAC2:NAME?  
                          Query the trace name for trace no. 2. The response is 'Ch2Trc2'.  
                          CONF:TRAC:CHAN:NAME? 'Ch2Trc2'  
                          Query the channel name for trace Ch2Trc2. The response is 'Ch2'.  
                          CONF:TRAC:CHAN:NAME:ID? 'Ch2Trc2'  
                          Query the channel number for trace Ch2Trc2. The response is 2.

**Usage:**                Query only

**Manual operation:** See ["Trace Manager Table"](#) on page 165

#### CONFigure:TRACe<Trc>:CHANnel:NAME? <TraceName>

Queries the channel name for an existing trace named '<TraceName>'.  
 <Trc>

**Suffix:**

<Trc>                    Trace number. This suffix is ignored; the trace is referenced by its name.

**Query parameters:**

<TraceName>            Trace name, e.g. 'Ch2Trc2'.

**Example:**             See [CONFigure:TRACe:CATalog?](#)

**Usage:**                Query only

**Manual operation:** See ["Add Ch + Trace"](#) on page 297

#### CONFigure:TRACe<Trc>:CHANnel:NAME:ID? <TraceName>

Queries the channel number (numeric suffix) for an existing trace named '<TraceName>'.  
 <Trc>

**Suffix:**

<Trc>                    Trace number. This suffix is ignored; the trace is referenced by its name.

**Query parameters:**

<TraceName>            Trace name, e.g. 'Ch2Trc2'.



**Example:** See [CONFigure:TRACe:CATalog?](#)

**Usage:** Query only

**Manual operation:** See "Add Ch + Trace" on page 297

#### **CONFigure:TRACe<Trc>:NAME <TraceName>**

Assigns a name to an existing trace number <Trc>. Note that it is not possible to assign the same name to two different traces. [CONFigure:TRACe:CATalog?](#) returns a list of all traces in the active recall set with their names.

**Suffix:**

<Trc> Number of an existing trace.

**Parameters:**

<TraceName> Trace name, e.g. 'Ch2Trc2'.

\*RST: 'Trc1'

**Example:** See [CONFigure:TRACe:CATalog?](#)

#### **CONFigure:TRACe<Trc>:NAME:ID? <TraceName>**

Queries the trace number (numeric suffix) of a trace with known trace name. [CONFigure:TRACe:CATalog?](#) returns a list of all traces in the active recall set with their names.

**Suffix:**

<Trc> Trace number. This suffix is not relevant and may be omitted (the command returns the actual trace number).

**Query parameters:**

<TraceName> Trace name, e.g. 'Ch2Trc2'.

**Example:** See [CONFigure:TRACe:CATalog?](#)

**Usage:** Query only

#### **CONFigure:TRACe<Trc>:REName <OldTraceName>, <NewTraceName>**

Assigns a new name to a trace. The trace does not have to be the active trace.

**Suffix:**

<Trc> Trace number. This suffix is ignored; the trace is identified via its <TraceName>

**Setting parameters:**

<OldTraceName> String parameter with old trace name, e.g. 'Trc1'

<NewTraceName> String parameter with new trace name, e.g. 'S11 Trace'

\*RST: n/a

**Example:** See [CONFigure:CHANnel<Ch>:TRACe:REName](#)

**Usage:** Setting only  
**Manual operation:** See "Trace Manager Table" on page 165

#### CONFigure:TRACe:WINDow? <TraceName>

Returns the trace number within a diagram which is assigned to the trace <TraceName> is assigned to. A zero is returned when the trace is not assigned/displayed.

The trace number is equal to the <WndTr> suffix in `DISPlay[:WINDow<Wnd>]:TRACe<WndTr>:FEED` and similiar commands; see example.

#### Query parameters:

<TraceName> Trace name (string), e.g. 'Trc1'

**Example:** See `CONFigure:TRACe:WINDow:TRACe?`

**Usage:** Query only

**Manual operation:** See "Add" on page 166

#### CONFigure:TRACe:WINDow:TRACe? <TraceName>

Returns the number of the diagram which the trace <TraceName> is assigned to. A zero is returned when the trace is not assigned/displayed.

The diagram number is equal to the <Wnd> suffix in `DISPlay[:WINDow<Wnd>]:TRACe<WndTr>:FEED` and similiar commands; see example.

#### Query parameters:

<TraceName> Trace name (string), e.g. 'Trc1'

**Example:** `*RST; :CALC:PAR:SDEF 'Trc2', 'S11'`  
 Create a new trace named Trc2.  
`CONF:TRAC:WIND:TRAC? 'Trc2'`  
 Query the diagram number for Trc2. The new trace is currently not displayed, so the response is 0.  
`DISP:WIND2:STAT ON`  
 Create a new diagram no. 2.  
`DISP:WIND2:TRAC3:FEED 'Trc2'`  
 Display the trace in the new diagram no. 2, assigning the trace number 3.  
`CONF:TRAC:WIND? 'Trc2'`  
 Query the diagram number for Trc2. The the response is 2.  
`CONF:TRAC:WIND:TRAC? 'Trc2'`  
 Query the trace number for Trc2. The the response is 3.

**Usage:** Query only

**Manual operation:** See "Add" on page 166

### 6.3.4 CONTROL Commands

The `Control...` commands control the USER PORT connector, the Handler I/O connector (Universal Interface, option R&S ZN-B14) and the RFFE/GPIO interface (option R&S ZN-B15).

<code>CONTROL:AUXiliary:C[:DATA]</code> .....	499
<code>CONTROL:HANDler:A[:DATA]</code> .....	501
<code>CONTROL:HANDler:B[:DATA]</code> .....	501
<code>CONTROL:HANDler:C[:DATA]</code> .....	501
<code>CONTROL:HANDler:D[:DATA]</code> .....	501
<code>CONTROL:HANDler:E[:DATA]</code> .....	501
<code>CONTROL:HANDler:F[:DATA]</code> .....	501
<code>CONTROL:HANDler:G[:DATA]</code> .....	501
<code>CONTROL:HANDler:H[:DATA]</code> .....	501
<code>CONTROL:HANDler:A:MODE</code> .....	501
<code>CONTROL:HANDler:B:MODE</code> .....	501
<code>CONTROL:HANDler:C:MODE</code> .....	502
<code>CONTROL:HANDler:D:MODE</code> .....	502
<code>CONTROL:HANDler[:EXTension]:INDEX:STATE</code> .....	502
<code>CONTROL:HANDler[:EXTension]:RTRigger:STATE</code> .....	502
<code>CONTROL:HANDler:INPut?</code> .....	503
<code>CONTROL:HANDler:LOGic</code> .....	503
<code>CONTROL:HANDler:OUTPut&lt;Pt&gt;:USER</code> .....	503
<code>CONTROL:HANDler:OUTPut&lt;Pt&gt;[:DATA]</code> .....	504
<code>CONTROL:HANDler:PASSfail:LOGic</code> .....	504
<code>CONTROL:HANDler:PASSfail:MODE</code> .....	505
<code>CONTROL:HANDler:PASSfail:POLicy</code> .....	505
<code>CONTROL:HANDler:PASSfail:SCOPE</code> .....	506
<code>CONTROL:HANDler:PASSfail:STATus?</code> .....	506
<code>CONTROL:HANDler:RESet</code> .....	507
<code>CONTROL:HANDler:SWEepend</code> .....	507
<code>CONTROL:GPIO:SENSe:SUMCurrent?</code> .....	507

---

#### `CONTROL:AUXiliary:C[:DATA]` <DecValue>

Sets or queries a channel-dependent eight-bit decimal value to control eight independent output signals at the USER PORT connector (lines 8, 9, 10, 11 and lines 16, 17, 18, 19). The output signals are 3.3 V TTL signals which can be used to differentiate between up to 255 independent analyzer states. `CONTROL:AUXiliary:C[:DATA]` itself does not change the analyzer state.

#### Channel bit definition and activation

The channel bits have the following properties:

- After a \*RST of the analyzer all channel bits (including the value for the active, sweeping channel no. 1) are set to zero; no signal is applied to pins 8 to 11 and 16 to 19 of the USER PORT connector.
- The value defined with `CONTROL:AUXiliary:C[:DATA]` is assigned to the **active** channel (`INSTRument:NSElect <Ch>`).

- The signals at the USER PORT connector reflect the channel bits of the **measuring** channel, i.e. the channel for which the analyzer performs a sweep. This channel is not necessarily identical with the active channel.
- The signals are switched on as soon as a measurement (sweep) in a channel with non-zero channel bits is started. They are changed whenever a channel with different channel bits becomes the measuring channel.
- The signals at the USER PORT connector are maintained after the analyzer enters the hold state. This happens if all channels use single sweep mode and if all sweep sequences have been terminated.
- Pins 16 to 19 may be reserved for monitoring the drive ports 1 to 4 of the analyzer (`OUTPut:UPORt:ECBits OFF`). This leaves up to 16 different monitored channel states.

**Tip:** A simple application consists of selecting the channel numbers as parameters for `CONTRol:AUXiliary:C[:DATA]` and monitor the activity of up to 255 different channels at the USER PORT connector; see example below. You can also use the USER PORT output signals as channel-dependent trigger signals for external devices. Use `OUTPut<Ch>:UPORt[:VALue]` to transfer the eight bit value for an arbitrary channel <Ch> in binary representation.

**Parameters:**

<DecValue>            Decimal value. The values correspond to the following states of the USER PORT connector:

0 - no signal at any of the no signal at any of the eight pins 8, 9, 10, 11, 16, 17, 18, 19

1 - output signal at pin 8

2 - output signal at pin 9

3 - output signal at pins 8 and 9

...

255 - output signal at pins 8, 9, 10, 11, 16, 17, 18, 19

Range:            0 to 255

\*RST:            0 (no signal)

**Example:**

`*RST; :CONT:AUX:C 1`

Assign the channel bit value 1 to the active channel no. 1. The analyzer performs a measurement in channel no. 1, therefore the output signal at pin 8 is switched on.

`CONF:CHAN2:STAT ON; :CONT:AUX:C 2`

Create channel no. 2, causing it to become the active channel, and assign the channel bit value 2. The analyzer performs no measurement in channel no. 2, therefore the output signal is not changed.

`CALC2:PAR:SDEF 'Ch2Tr1', 'S11'`

Create a trace named 'Ch2Tr1' and assign it to channel 2. While the analyzer measures in channel 2, the output signal changes from pin 8 to pin 9.

**Manual operation:** See "[Table Columns](#)" on page 248

---

```

CONTRol:HANDler:A[:DATA] <DecValue>
CONTRol:HANDler:B[:DATA] <DecValue>
CONTRol:HANDler:C[:DATA] <DecValue>
CONTRol:HANDler:D[:DATA] <DecValue>
CONTRol:HANDler:E[:DATA] <DecValue>
CONTRol:HANDler:F[:DATA] <DecValue>
CONTRol:HANDler:G[:DATA] <DecValue>
CONTRol:HANDler:H[:DATA] <DecValue>

```

The setting commands write data to ports A, B, C, D, E, F, G, H. To write data to a port, the port must be configured as an output port (see example). By default, the port lines have negative logic: A "0" at a pin corresponds to a high signal, a "1" to a low signal. The logic can be changed using [CONTRol:HANDler:LOGicPOSitive](#). When writing to port G, port C must be configured as an output port. When writing to port H, port C and port D must be configured as output ports (see [CONTRol:HANDler:D:MODE](#)).

The queries read data from ports A, B, C, D, E, F, G, H. If the port is an output port, the queries return the last value that was written to the port.

**Parameters:**

<DecValue>                    Decimal representation for an n-bit binary value. The ranges are:  
 Port A: 0 to 255 (pins A7 ... A0)  
 Port B: 0 to 255 (pins B7 ... B0)  
 Port C: 0 to 15 (pins C3 ... C0)  
 Port D: 0 to 15 (pins D3 ... D0)  
 Port E: 0 to 255 (pins D3 ... D0 C3 ... C0)  
 Port F: 0 to 65535 (pins B7 ... B0 A7 ... A0)  
 Port G: 0 to 1048575 (pins C3 ... C0 B7 ... B0 A7 ... A0)  
 Port H: 0 to 16777215 (pins D3 ... D0 C3 ... C0 B7 ... B0 A7 ... A0)

The parameters `MIN`, `MAX`, `DEF` are not supported.

**Note:** \*RST or "Preset" do not change the configuration of the Universal Interface. Use [CONTRol:HANDler:RESet](#) to restore default values.

\*RST:                    n/a (default: 0 (port A, B, and F); ports C, D, and E are configured as input ports.)

**Example:**

```

CONT:HAND:A:MODE OUTP
Configure port A as an output port.
CONT:HAND:A 192
Write data to port A.
CONT:HAND:B:MODE INP
Configure port B as an input port.
CONT:HAND:B?
Read data from port B.

```

---

```

CONTRol:HANDler:A:MODE <Mode>
CONTRol:HANDler:B:MODE <Mode>

```

**CONTRol:HANDler:C:MODE** <Mode>

**CONTRol:HANDler:D:MODE** <Mode>

Controls the direction of the data flow at ports A, B, C, D. The direction at the combined ports E, F, G, H is according to the configuration at the other ports.

**Parameters:**

<Mode>                    INPut | OUTPut  
 INPut – Input of data at the port  
 OUTPut – Output of data at the port  
**Note:** \*RST or "Preset" do not change the configuration of the Universal Interface. Use [CONTRol:HANDler:RESet](#) to restore default values.  
 \*RST:                    n/a (default: Port A and B: OUTPut (also valid for port F); port C and D: INPut (also valid for port E). Ports G and H have mixed default modes.)

**Example:**                    See [CONTRol:HANDler:A\[:DATA\]](#)

**CONTRol:HANDler[:EXTension]:INDEX:STATe** <Boolean>

Selects the digital signal that is routed to pin 20 of the Universal Interface connector.

**Parameters:**

<Boolean>                    ON - /INDEX signal at pin 20  
 OFF - /PORT\_B6 signal at pin 20  
 \*RST:                    n/a (default: OFF)  
**Note:** \*RST or "Preset" do not change the configuration of the Universal Interface. Use [CONTRol:HANDler:RESet](#) to restore default values.

**Example:**                    `CONT:HAND:EXT:IND:STAT ON`  
 Route the /INDEX signal to pin 20.  
`CONT:HAND:EXT:RTR:STAT ON`  
 Route the /READY\_FOR\_TRIGGER signal to pin 21.  
`CONT:HAND:RES`  
 Restore the default state: Pins no. 20 and 21 are available for port B input/output signals.

**CONTRol:HANDler[:EXTension]:RTRigger:STATe** <Boolean>

Selects the digital signal that is routed to pin 21 of the Universal Interface connector.

**Parameters:**

<Boolean>                    ON - /READY\_FOR\_TRIGGER  
 OFF - /PORT\_B7 signal at pin 21  
**Note:** \*RST or "Preset" do not change the configuration of the Universal Interface. Use [CONTRol:HANDler:RESet](#) to restore default values.  
 \*RST:                    n/a (default: OFF)

**Example:** See `CONTrol:HANDler[:EXTension]:INdex:STATe`

---

### CONTrol:HANDler:INPut?

Queries whether a high to low transition occurred at the /INPUT 1 line (pin 2) of the Universal Interface since the last `CONTrol:HANDler:INPut?` query. The query resets the counter to zero.

A negative pulse fed to this line also causes the /OUTPUT 1 and /OUTPUT 2 lines (pins 3 and 4) to change to low.

#### Return values:

<NumberOfTrans> 0, if no transition was detected since last query  
1, if one or more transitions were detected.

**Example:** `CONTrol:HANDler:INPut?`  
Query whether a high to low transition occurred.

**Usage:** Query only

---

### CONTrol:HANDler:LOGic <Logic>

Selects the logic of the data ports A to H of the Universal Interface. For output ports, a change in logic reverses the state of the output lines immediately. For input ports, a change in logic will be reflected next time when data is read.

#### Parameters:

<Logic> POSitive | NEGative  
 POSitive – 0 = low, 1 = high  
 NEGative – 0 = high, 1 = low  
**Note:** \*RST or "Preset" do not change the configuration of the Universal Interface. Use `CONTrol:HANDler:RESet` to restore default values.  
 \*RST: n/a (default: NEGative)

**Example:** `CONTrol:HANDler:LOGic POS`  
Change the logic of the data ports to positive.

---

### CONTrol:HANDler:OUTPut<Pt>:USER <BinValue>

Defines the state of the output ports (pin 3 or 4) of the Universal Interface connector after the next negative pulse on the /INPUT1 line (pin 2).

#### Suffix:

<Pt> Output port number:  
 1 - /OUTPUT1 (pin 3)  
 2 - /OUTPUT2 (pin 4)  
 The parameters MIN, MAX, DEF are not supported.  
**Note:** \*RST or "Preset" do not change the configuration of the Universal Interface. Use `CONTrol:HANDler:RESet` to restore default values.

**Parameters:**

<BinValue>            0 - high 1 - low  
 \*RST:                n/a (default: 0)

**Example:**            See `CONTrol:HANDler:OUTPut<Pt>[:DATA]`

**CONTrol:HANDler:OUTPut<Pt>[:DATA] <BinValue>**

Writes a 0 or 1 to the output ports (pin 3 or 4) of the Universal Interface connector. The port lines have negative logic: A "0" corresponds to a high signal, a "1" to a low signal.

The query reads the last value that has been written to the output port.

**Suffix:**

<Pt>                    Output port number:  
 1 - /OUTPUT1 (pin 3)  
 2 - /OUTPUT2 (pin 4)  
 The parameters `MIN`, `MAX`, `DEF` are not supported.  
**Note:** \*RST or "Preset" do not change the configuration of the Universal Interface. Use `CONTrol:HANDler:RESet` to restore default values.

**Parameters:**

<BinValue>            0 - high  
 1 - low  
 \*RST:                n/a (default: 0)

**Example:**            `CONT:HAND:OUTP2:DATA 0`  
 Set the /OUTPUT2 line (pin 4) to 0 (current state of /OUTPUT2).  
`CONT:HAND:OUTP2:USER 1`  
 Define the next state of the /OUTPUT2 line as 1 (low). /OUTPUT2 will go from 0 to 1 when the analyzer receives a negative pulse on the /INPUT1 line (pin 2).

**CONTrol:HANDler:PASSfail:LOGic <Logic>**

Specifies the the logic of the /PASS FAIL line (pin 33) of the Universal Interface.

**Parameters:**

<Logic>                POSitive | NEGative  
 POSitive – high meas PASS, low means FAIL  
 NEGative – low meas PASS, high means FAIL  
**Note:** \*RST or "Preset" do not change the configuration of the Universal Interface. Use `CONTrol:HANDler:RESet` to restore default values.  
 \*RST:                n/a (default: POSitive)

**Example:**            See `CONTrol:HANDler:PASSfail:MODE`



**CONTROL:HANDLER:PASSfail:MODE** <Mode>

Specifies the default logical pass/fail state and the timing of the /PASS FAIL line (pin 33). The /PASS FAIL STROBE (pin 36) is set after the /PASS FAIL line; see [Chapter 9.1.4.4, "Timing of Control Signals"](#), on page 815.

If the mode is PASS or FAIL, the /PASS FAIL line is returned to its default state when the analyzer is ready for a new measurement (/READY FOR TRIGGER).

**Parameters:**

&lt;Mode&gt;

NOWait | PASS | FAIL

NOWait – the /PASS FAIL line is set as soon as a failure condition occurs.

PASS – the line stays in PASS state (as defined by [CONTROL:HANDLER:PASSfail:LOGic](#)) until a sweep end condition (determined by [CONTROL:HANDLER:PASSfail:SCOPE](#)) occurs.

FAIL – the line stays in FAIL state until a sweep end condition occurs.

**Note:** \*RST or "Preset" do not change the configuration of the Universal Interface. Use [CONTROL:HANDLER:RESet](#) to restore default values.

\*RST: n/a (default: NOWait)

**Example:**

Configure the /SWEEP END (pin 34) and /PASS FAIL (pin 33) signals:

```
CONTROL:HANDLER:SWEepend GLOBAL
```

Set the /SWEEP END line to low when all sweeps in all channels are complete.

```
CONTROL:HANDLER:PASSFail:MODE PASS
```

Set the default state of the /PASS FAIL line to PASS.

```
CONTROL:HANDLER:PASSFail:SCOPE GLOBAL
```

Set the /PASS FAIL line when all sweeps in all channels are complete.

```
CONTROL:HANDLER:PASSFail:LOGic POSitive
```

Set the /PASS FAIL line to positive logic.

```
CONTROL:HANDLER:PASSFail:POLicy ALLTests
```

Return pass only if all tests pass.

**CONTROL:HANDLER:PASSfail:POLicy** <Policy>

Specifies how the global pass/fail status ([CONTROL:HANDLER:PASSfail:STATus?](#) on page 506) is calculated.

**Parameters:**

&lt;Policy&gt;

ALLTests | ALLMeas

ALLTests – the status is PASS if all limit checks in all measurements (traces) pass.

ALLMeas – the status is PASS if a limit check is defined for all measurements (traces) and all limit checks pass. It is FAIL if one or more traces have no associated limit check, or if at least one limit check fails.

**Note:** \*RST or "Preset" do not change the configuration of the Universal Interface. Use `CONTrol:HANDler:RESet` to restore default values.

**Example:**See `CONTrol:HANDler:PASSfail:MODE`**CONTrol:HANDler:PASSfail:SCOPE** <Scope>

Specifies the "sweep end" condition that will cause the /PASS FAIL line (pin 33) to report the status of the global limit check.

**Note:** This setting is not valid if the pass/fail mode is NOWait (`CONTrol:HANDler:PASSfail:MODENOWait`).

**Parameters:**

&lt;Scope&gt;

GLOBal | CHANnel

CHANnel – when all the sweeps for each channel are complete

GLOBal – when all sweeps in all channels are complete

**Note:** \*RST or "Preset" do not change the configuration of the Universal Interface. Use `CONTrol:HANDler:RESet` to restore default values.

\*RST: n/a (default: GLOBal)

**Example:**See `CONTrol:HANDler:PASSfail:MODE`**CONTrol:HANDler:PASSfail:STATus?**

Returns the global pass/fail status of the last measurement.

**Return values:**

&lt;Status&gt;

PASS | FAIL | NONE

PASS – all measurements that are not in single sweep mode (on hold) have been swept, and all limit checks have been passed.

FAIL – all measurements that are not in single sweep mode (on hold) have been swept, at least one limit check failed according to the specified pass/fail policy (`CONTrol:HANDler:PASSfail:POLicy`).

NONE – no pass/fail status available, e.g. because the measurement is in progress or because no limit check has been defined.

\*RST: n/a

**Example:** Preparations: Configure and enable a limit check. Start a measurement and wait until the sweep is complete.  
`CONTrol:HANDler:PASSfail:STATus?`  
 Query the result of the global limit check.

**Usage:** Query only

### **CONTrol:HANDler:RESet**

Restores the default states of the `CONTrol:HANDler...` commands including the data port values.

**Example:** See `CONTrol:HANDler[:EXTension]:INDEX:STATe`

**Usage:** Event

### **CONTrol:HANDler:SWEpend <SweepEnd>**

Specifies the event that will cause the /SWEEP END line (pin 34) to go low; see [Chapter 9.1.4.4, "Timing of Control Signals"](#), on page 815.

#### **Parameters:**

<SweepEnd>      SWEep | CHANnel | GLOBal  
 SWEep – every time a sweep is complete  
 CHANnel – when all the sweeps for each channel are complete  
 GLOBal – when all sweeps in all channels are complete  
**Note:** \*RST or "Preset" do not change the configuration of the Universal Interface. Use `CONTrol:HANDler:RESet` to restore default values.  
 \*RST:          n/a (default: GLOBal)

**Example:** See `CONTrol:HANDler:PASSfail:MODE`

### **CONTrol:GPIO:SENSe:SUMCurrent? <GpioPorts>**

Returns the sum of the currents measured at the specified GPIO ports

#### **Query parameters:**

<GpioPorts>      Comma-separated list of GPIO port numbers  
 The list must contain minimum two and maximum 10 numbers between 1 and 10 in arbitrary order.

**Example:** `CONTrol:GPIO:SENSe:SUMCurrent? 1,2,3,4,5`  
 returns the sum of the currents measured in GPIO ports 1 to 5

**Usage:** Query only

**Options:** R&S ZN-B15 Var. 03

### 6.3.5 DIAGnostic Commands

The `DIAGnostic...` commands provide access to service and diagnostic routines used in service, maintenance and repair. In accordance with the SCPI standard all commands are device-specific.

Service functions are password-protected (`SYSTem:PASSword[:CENable]`) and should be used by an R&S service representative only. Refer to the service manual for more information.

<code>DIAGnostic:DEvice:STATe</code> .....	508
<code>DIAGnostic:PRODUct:OPTion:INFO?</code> .....	508
<code>DIAGnostic:SERVice:RFPower</code> .....	509
<code>DIAGnostic:SERVice:SFUNction</code> .....	509
<code>DIAGnostic:DUMP:SIZE</code> .....	509

---

#### `DIAGnostic:DEvice:STATe` <Filename>

Generates a system report and writes it to the specified file. See [Chapter 8.1.3, "Obtaining Technical Support"](#), on page 800.

##### Setting parameters:

<Filename> String parameter containing the file name. If no path is specified, the file is stored to the directory `C:\Users\Public\Documents\Vna\Report`; the extension `*.zip` is appended automatically.

\*RST: n/a

##### Example:

```
DIAG:DEV:STAT 'report_16032011_1120'
```

Generate a report and store it to `C:\Users\Public\Documents\Vna\Report\report_16032011_1120`. Use the `MMEMory...` commands to rename, move, or delete the file.

**Usage:** Setting only

**Manual operation:** See ["Save... / Print... / Save Report"](#) on page 342

---

#### `DIAGnostic:PRODUct:OPTion:INFO?` <Option>, <Detail>

Queries a property of an installed software option, identified by its name.

##### Query parameters:

<Option> Option name, e.g. 'ZNC-K2' or 'ZND-K2'

<Detail> `DESCRiption | TYPE | ACTivation | EXPIration | KEY`

You can query for an option's `DESCRiption`, its `KEY` and key `TYPE`, and its `ACTivation` and `EXPIration` date (if applicable).

##### Example:

```
DIAGnostic:PRODUct:OPTion:INFO? 'ZNC-K2',DESC
```

On a R&S ZNC this returns 'Time Domain Analysis' (if installed)

**Usage:** Query only

**Manual operation:** See ["Software Option Info"](#) on page 343

---

#### **DIAGnostic:SERVice:RFPower** <Boolean>

Turns the internal source power at all ports and the power of all external generators on or off. This command is equivalent to `OUTPut<Ch>[:STATe]` .

#### **Parameters:**

<Boolean> ON | OFF - switch the power on or off.  
\*RST: ON

#### **Example:**

```
DIAG:SERV:RFP OFF
Turn off the RF source power.
```

---

#### **DIAGnostic:SERVice:SFUNction** <SFIdentifier>

Calls a service function (mainly for internal use).

- Use `SYSTem:PASSword[:CENable]` to activate the required service level.
- Use the query form to read back the data returned by the service function.

#### **Parameters:**

<SFIdentifier> Service function in "dotted textual" (example: 'sw.common.memory\_usage') or "dotted decimal" (example: '0.1.18.0') representation.

#### **Example:**

```
DIAGnostic:SERVice:SFUNction?
'sw.common.memory_usage'
```

This is an "Info Level" service function, i.e. it is not password-protected. It returns the current memory usage of the analyzer firmware.

**Manual operation:** See ["Service Function"](#) on page 345

---

#### **DIAGnostic:DUMP:SIZE** <DumpSize>

Determines the level of detail and hence the size of the dump files created in case of firmware exceptions.

#### **Parameters:**

<DumpSize> NONE | MINI | NORMAl | LARGe | FULL  
Either disables dump file creation (NONE) or determines the level of detail.

**Manual operation:** See ["Error Dump Type"](#) on page 340

### 6.3.6 DISPlay Commands

The `DISPlay...` commands control the selection and presentation of graphical and trace information on the screen.



### Trace display

Traces are generally identified by a string parameter defining the trace name (e.g. `CALCulate<Ch>:PARAmeter:SELEct <TraceName>`). In the `DISPlay...` subsystem, traces are assigned to diagrams (`DISPlay[:WINDow<Wnd>]:TRACe<WndTr>:FEED <TraceName>`). While this assignment is valid, the trace is identified by the numeric suffix `<Wnd>`, and the trace name is not needed.

### Units for DISPlay... commands

The `DISPlay...` subsystem contains commands to define particular points in the diagram, e.g. to set the scale or a reference value. This requires the entry of a numeric value and a physical unit, depending on the parameter type displayed. The following table lists the physical units accepted by the analyzer.

Power	DBM, DB, DBW, W, MW, UW, NW, PW
Voltage	V, MV, UV, NV, PV, DBV, DBMV, DBUV
Phase	DEG, KDEG, MDEG, UDEG, NDEG, PDEG
Group delay	S, MS, US, NS, PS
Impedance	OHM, GOHM, MOHM, KOHM
Admittance	SIE, MSIE, USIE, NSIE
Inductance	H, MH, UH, NH, PH, FH
Capacitance	F, MF, UF, NF, PF, FF
Dimensionless	UNIT, MUNIT, UUNIT, NUNIT, PUNIT, FUNIT

<code>DISPlay:ANNotation:CHANnel[:STATe]</code> .....	511
<code>DISPlay:ANNotation:TRACe[:STATe]</code> .....	511
<code>DISPlay:ANNotation:FREQuency[:STATe]</code> .....	511
<code>DISPlay:CMAP:LIMit:FCOLorize[:STATe]</code> .....	512
<code>DISPlay:CMAP:LIMit:FSYMBOL[:STATe]</code> .....	512
<code>DISPlay:CMAP:LIMit[:STATe]</code> .....	512
<code>DISPlay:CMAP:MARKer[:STATe]</code> .....	513
<code>DISPlay:CMAP&lt;DispEl&gt;:RGB</code> .....	513
<code>DISPlay:CMAP:TRACe:COLor[:STATe]</code> .....	515
<code>DISPlay:CMAP:TRACe:RGB</code> .....	515
<code>DISPlay:LAYout</code> .....	516
<code>DISPlay:LAYout:APPLY</code> .....	516
<code>DISPlay:LAYout:DEFine</code> .....	517
<code>DISPlay:LAYout:EXECute</code> .....	518
<code>DISPlay:LAYout:GRID</code> .....	518
<code>DISPlay:LAYout:JOIN</code> .....	519
<code>DISPlay:MENU:KEY:ACTion:CATalog?</code> .....	519
<code>DISPlay:MENU:KEY:EXECute</code> .....	519
<code>DISPlay:MENU:KEY:SELEct</code> .....	520
<code>DISPlay:MENU:KEY:TOOL:CATalog?</code> .....	520
<code>DISPlay:RFSize</code> .....	520

DISPlay[:WINDow<Wnd>]:CATalog?	521
DISPlay[:WINDow<Wnd>]:MAXimize	521
DISPlay[:WINDow<Wnd>]:OVERview[:STATe]	522
DISPlay[:WINDow<Wnd>]:NAME	522
DISPlay[:WINDow<Wnd>][:STATe]	522
DISPlay[:WINDow<Wnd>]:TITLe:DATA	523
DISPlay[:WINDow<Wnd>]:TITLe[:STATe]	523
DISPlay[:WINDow<Wnd>]:TRACe<WndTr>:CATalog?	524
DISPlay[:WINDow<Wnd>]:TRACe<WndTr>:DELeTe	524
DISPlay[:WINDow<Wnd>]:TRACe<WndTr>:EFEEd	524
DISPlay[:WINDow<Wnd>]:TRACe<WndTr>:FEED	525
DISPlay[:WINDow<Wnd>]:TRACe<WndTr>:SHOW	526
DISPlay[:WINDow<Wnd>]:TRACe<WndTr>:X:OFFSet	527
DISPlay[:WINDow<Wnd>]:TRACe<WndTr>:Y:OFFSet	527
DISPlay[:WINDow<Wnd>]:TRACe<WndTr>:Y[:SCALE]:AUTO	528
DISPlay[:WINDow<Wnd>]:TRACe<WndTr>:Y[:SCALE]:PDIVision	529
DISPlay[:WINDow<Wnd>]:TRACe<WndTr>:Y[:SCALE]:RLEVel	529
DISPlay[:WINDow<Wnd>]:TRACe<WndTr>:Y[:SCALE]:RPOSition	530
DISPlay[:WINDow<Wnd>]:TRACe<WndTr>:Y[:SCALE]:BOTTom	531
DISPlay[:WINDow<Wnd>]:TRACe<WndTr>:Y[:SCALE]:TOP	531
DISPlay[:WINDow<Wnd>]:TRACe<WndTr>:ZOOM[:STATe]	532
DISPlay[:WINDow<Wnd>]:TRACe<WndTr>:ZOOM:STARt	533
DISPlay[:WINDow<Wnd>]:TRACe<WndTr>:ZOOM:STOP	533
DISPlay[:WINDow<Wnd>]:TRACe<WndTr>:ZOOM:BOTTom	534
DISPlay[:WINDow<Wnd>]:TRACe<WndTr>:ZOOM:TOP	534

---

**DISPlay:ANNotation:CHANnel[:STATe]** <Boolean>

**DISPlay:ANNotation:TRACe[:STATe]** <Boolean>

Shows or hides the channel/trace list(s) in all diagrams of the current recall set.

**Parameters:**

<Boolean>            ON | OFF - show or hide information element(s).  
 \*RST:                ON

**Example:**

\*RST; :DISP:ANN:TRAC OFF; CHAN ON; FREQ OFF  
 Create diagram area no. 1 (with default trace) and hide the trace list. Keep the channel list but hide the swept frequency range.

**Manual operation:** See "Trace Info" on page 327

---

**DISPlay:ANNotation:FREQuency[:STATe]** <Boolean>

Unmasks or masks all stimulus values in the VNA GUI for the active recall set.

**Parameters:**

<Boolean>            ON | OFF - unmask or mask stimulus values  
 \*RST:                ON - all stimulus values unmasked

**Example:**

\*RST; :DISP:ANN:FREQ OFF  
 Create diagram area no. 1 (with default trace) and mask all stimulus values.

**Manual operation:** See ["Hide Sensitive Information"](#) on page 327

#### **DISPlay:CMAP:LIMit:FCOLorize[:STATe]** <Boolean>

Assigns a different trace color to failed trace segments ("Colorize Trace when Failed").

##### **Parameters:**

<Boolean> ON | OFF - colorize trace or keep original trace color.  
 \*RST: n/a (a \*RST does not affect the setting). In the factory configuration, OFF is preset.

**Example:** See [DISPlay:CMAP:LIMit\[:STATe\]](#)

**Manual operation:** See ["Limit Test > Colorize Trace when Failed"](#) on page 329

#### **DISPlay:CMAP:LIMit:FSYMBOL[:STATe]** <Boolean>

Displays or hides the limit fail symbols (colored squares) on the trace.

##### **Parameters:**

<Boolean> ON | OFF - show or hide symbols.  
 \*RST: n/a (a \*RST does not affect the setting). In the factory configuration, ON is preset.

**Example:** See [DISPlay:CMAP:LIMit\[:STATe\]](#)

**Manual operation:** See ["Limit Test > Show Limit Fail Symbols"](#) on page 329

#### **DISPlay:CMAP:LIMit[:STATe]** <Boolean>

Displays all limit lines either with individually configured colors or with the color of the associated trace(s). The colors of all display elements are defined via [DISPlay:CMAP<DispEl>:RGB](#).

##### **Parameters:**

<Boolean> ON - the limit line colors are defined via [DISPlay:CMAP<DispEl>:RGB](#) where <DispEl> = 9 ... 12. The limit line colors are independent of the trace colors.  
 OFF - all limit lines have the color of the associated trace.  
 \*RST: n/a (a \*RST does not affect the setting). In the factory configuration, OFF is preset.

##### **Example:**

```
DISP:CMAP:LIMit OFF
Use the trace colors for all limit lines associated with each trace.
Subsequent limit line color definitions will be ignored until individual
limit settings are enabled again.
DISPlay:CMAP:LIMit:FCOLorize:STATe ON
Assign a different trace color to failed trace sections.
DISPlay:CMAP:LIMit:FSYMBOL:STATe OFF
Remove the limit fail symbols from the trace.
```



**Manual operation:** See ["Limit Test > Use Trc Color for Limit Lines"](#) on page 329

---

### DISPlay:CMAP:MARKer[:STATe] <Boolean>

Displays all markers with the same color or display each marker with the color of the associated trace. The colors of all display elements are defined via

DISPlay:CMAP<DispEl>:RGB <Red>, <Green>, <Blue> ...

#### Parameters:

<Boolean> ON - all markers have the same color, to be defined via  
 DISPlay:CMAP<DispEl>:RGB <Red>, <Green>, <Blue>.  
 The marker color is independent of the trace colors.  
 OFF - each marker has the color of the associated trace.

**Example:** See DISPlay:CMAP<DispEl>:RGB

**Manual operation:** See ["General > Same Color all Markers"](#) on page 330

---

### DISPlay:CMAP<DispEl>:RGB <Red>, <Green>, <Blue>[, <TraceStyle>, <TraceWidth>]

Defines the color of all display elements based on the Red/Green/Blue color model.

#### Suffix:

<DispEl> Number of the display element. The display elements corresponding to the numbers 1 to 20 are listed below.

#### Parameters:

<Red> Red content of the defined color.  
 Range: 0 (zero intensity, corresponding to a 0 in the 24-bit color model) to 1 (full intensity, corresponding to 255 in the 24-bit color model).

<Green> Green content of the defined color.  
 Range: 0 (zero intensity, corresponding to a 0 in the 24-bit color model) to 1 (full intensity, corresponding to 255 in the 24-bit color model).

<Blue> Blue content of the defined color.  
 Range: 0 (zero intensity, corresponding to a 0 in the 24-bit color model) to 1 (full intensity, corresponding to 255 in the 24-bit color model).

<TraceStyle> SOLid | DASHed | DOTTed | DDOTted | DDDotted  
 Optional trace style, only for traces (<DispEl> > 12): One of the string parameters SOLid | DASHed | DOTTed | DDOTted | DDDotted.

<TraceWidth> Optional trace width, only for traces (<DispEl> > 12).  
 Range: 1 to 20

**Example:**

```
*RST; :DISP:CMAP:MARK ON; :CALC:MARK ON
```

Create diagram area no. 1 (with default trace showing the S-parameter  $S_{21}$ ) and a marker M1.

```
CALC:PAR:SDEF 'Trc2', 'S11'
```

```
DISP:WIND:TRAC2:FEED 'TRC2'
```

Create a new trace named Trc2 and display the trace in diagram area no. 1. Note that the new trace automatically becomes the active trace.

```
CALC:MARK2 ON
```

Assign a marker M2 to the trace. Both markers are displayed with the same color.

```
DISP:CMAP13:RGB 1,0,0; :DISP:CMAP14:RGB 0,1,0
```

Color the first trace red, the second trace green.

```
DISP:CMAP6:RGB?
```

Query the marker color. The marker color depends on the settings made in previous sessions; it is not reset. A possible response is 0,0,0 for black markers.

```
DISP:CMAP:MARK OFF
```

Change the marker colors: M1 turns red, M2 turns green.

**Manual operation:** See "[Element](#)" on page 328

The numeric suffixes <DispEl> denote the following display elements:

<DispEl>	Display Element
1	Background
2	Text
3	Selected Text
4	Grid
5	Reference Line
6	Same Color for all Markers
7	Horizontal Line / Vertical Range Lines
8	Diagram Title
9	Limit Fail Trace Color
10	Limit Line Type Off
11	Limit Line Type Upper
12	Limit Line Type Lower
13	Trace 1 (see also <a href="#">DISPlay:CMAP:TRACe:RGB</a> )
14	Trace 2
15	Trace 3
16	Trace 4
17	Trace 5

<DispEl>	Display Element
18	Trace 6
19	Trace 7
20	Trace 8

---

**DISPlay:CMAP:TRACe:COLor[:STATe] <Boolean>**

Defines the trace color schemes in different diagram areas.

**Parameters:**

<Boolean>                    OFF - independent color scheme in new diagram area. Moved traces change their color.  
                                   ON - color scheme in new diagram area continues the previous color scheme. Moved traces keep their color.

**Example:**

```
*RST; :DISP:CMAP13:RGB 1,0,0
Create diagram area no. 1 (with default trace showing the S-
parameter S21) and color the trace red.
DISP:CMAP:TRAC:COL OFF; :DISP:WIND2:STAT ON
Select independent color schemes for new diagram areas. Cre-
ate a new diagram area no. 2.
CALC:PAR:SDEF 'Trc2', 'S11'; :DISP:WIND2:TRAC2:
FEED 'TRC2'
Create a new trace named Trc2 and display the trace in a new
diagram area no. 2. The new trace is red like the first trace.
DISP:CMAP:TRAC:COL ON; :DISP:WIND3:STAT ON
Continue the same color scheme in new diagram areas. Create
a new diagram area no. 3.
CALC:PAR:SDEF 'Trc3', 'S22'; :DISP:WIND3:TRAC3:
FEED 'Trc3'
Create a new trace named Trc3 and display the trace in a new
diagram area no. 3. The new trace is not red.
```

**Manual operation:** See "[General > Trace Colors per Diagram](#)" on page 329

---

**DISPlay:CMAP:TRACe:RGB <TraceName>, <Red>, <Green>, <Blue>[, <TraceStyle>, <TraceWidth>]**

Defines the color of a trace referenced by its name, based on the Red/Green/Blue color model. Use the generalized command `DISPlay:CMAP<DispEl>:RGB` to define the color of other display elements.

**Parameters:**

<TraceName>                Trace name, string parameter

<Red>                        Red content of the defined color.

Range:                      0 (zero intensity, corresponding to a 0 in the 24-bit color model) to 1 (full intensity, corresponding to 255 in the 24-bit color model).

<Green>	Green content of the defined color. Range: 0 (zero intensity, corresponding to a 0 in the 24-bit color model) to 1 (full intensity, corresponding to 255 in the 24-bit color model).
<Blue>	Blue content of the defined color. Range: 0 (zero intensity, corresponding to a 0 in the 24-bit color model) to 1 (full intensity, corresponding to 255 in the 24-bit color model).
<TraceStyle>	SOLid   DASHed   DOTTed   DDOTted   DDDotted Optional trace style, only for traces (<DispEl> > 12): One of the string parameters SOLid   DASHed   DOTTed   DDOTted   DDDotted.
<TraceWidth>	Optional trace width, only for traces (<DispEl> > 12). Range: 1 to 20
<b>Example:</b>	*RST; :DISP:CMAP:TRAC:RGB 'Trc1', 1, 0, 0 Color the default trace 'Trc1' red. See also DISPLAY:CMAP<DispEl>:RGB
<b>Manual operation:</b>	See " <a href="#">Properties</a> " on page 328

---

#### DISPlay:LAYout <LayoutMode>

Arranges the diagrams in the screen, leaving the diagram contents unchanged.

##### Parameters:

<LayoutMode>	LINEup   STACK   HORizontal   VERTical   GRID LINEup – the diagrams are arranged side by side. STACK – the diagrams are arranged one on top of the other. HORizontal – the diagrams are arranged in horizontal rows. VERTical – the diagrams are arranged in vertical rows. GRID – the diagrams are arranged as a rectangular matrix. The number of rows and columns is as defined with command <a href="#">DISPlay:LAYout:GRID</a> .
--------------	--

**Example:** See [DISPlay:LAYout:GRID](#)

**Manual operation:** See "[Split Type / Diagrams / Rows / Columns](#)" on page 325

---

#### DISPlay:LAYout:APPLY <LayoutId>

Selects a previously defined layout for display in the analyzer screen.

##### Parameters:

<LayoutId>	Integer value 1, 2 ... Current number, as defined by <a href="#">DISPlay:LAYout:DEFine</a> .
------------	---

**Example:** See [Creating Diagrams](#)

**Manual operation:** See ["Additional Functionality: SCPI Commands"](#) on page 325

**DISPlay:LAYout:DEFine** <LayoutId>, <LayoutFormatMode>, <LayoutData>

**DISPlay:LAYout:DEFine?** <LayoutId>

Creates a horizontal or vertical display layout and provides it with an identifier (<LayoutId>).

Layouts are defined row by row (horizontal layouts) or column by column (vertical layouts).

- A horizontal layout consists of N rows, each of height  $h_i$  ( $i = 1$  to N). The heights are defined in units relative to the total height of the screen, i.e. their sum  $h_1 + h_2 + \dots + h_N$  must be equal to 1.00.  
Each row contains a selectable number of diagrams with independent widths  $w_{ij}$  ( $j = 1, 2 \dots M(i)$ ). The sum of the widths in each row must also match the screen width, hence  $w_{i1} + w_{i2} + \dots + w_{iM(i)} = 1.00$  for all rows ( $i = 1$  to N).  
The <LayoutData> string for horizontal layouts reads ' $h_1, w_{11}, w_{12} \dots w_{1M(1)}; h_2, w_{21}, w_{22} \dots w_{2M(2)}; \dots; h_N, w_{N1}, w_{N2} \dots w_{NM(N)}$ '.  
A semicolon separates different rows, a comma separates different diagram widths within a row.
- The definition of a vertical layout is analogous, however, the role of rows and columns is interchanged.

The query returns the layout data in an alternative, executable format. The executable format is also used by [DISPlay:LAYout:EXECute](#).

Use [DISPlay:LAYout:JOIN](#) or [DISPlay:LAYout:EXECute](#) to create more complicated (nested) layouts.

**Note:** The maximum number of diagrams in a layout is 256.

**Parameters:**

<LayoutFormatMode> HORIZONTAL | VERTICAL

Horizontal or vertical layout; see above.

<LayoutData> String parameter defining the number of diagrams and their position (easy format); see above.

**Parameters for setting and query:**

<LayoutId> Integer value 1, 2 ...

Current number, used by other [DISPlay:LAYout...](#) commands to reference the created layout.

**Example:** See [Creating Diagrams](#)

**Manual operation:** See ["Additional Functionality: SCPI Commands"](#) on page 325

**DISPlay:LAYout:EXECute** <LayoutData>

Creates and displays a horizontal or vertical display layout. The query returns the layout data of the currently displayed layout (the last layout selected via **DISPlay:LAYout:APPLY**) in executable format.

The executable format is an extension of the easy format used by **DISPlay:LAYout:DEFine**.

- The <LayoutData> string consists of two parts: <LayoutData> = '(<StartFormat>,<RepeatFormat<sub>1</sub>>,<RepeatFormat<sub>2</sub>> ...)'. The <StartFormat> descriptor distinguishes between horizontal and vertical layouts and defines the number of rows or columns. A <RepeatFormat> descriptor follows for each row or column in the layout. The <RepeatFormat> descriptors can be nested in order to describe joined layouts; refer to [Creating Diagrams](#) for an easy example.
- For a horizontal layout with N rows, each of height  $h_i$  ( $i = 1 \dots N$ ) and filled with  $M(i)$  diagrams with independent widths  $w_{ij}$  ( $j = 1, 2 \dots M(i)$ ), the data string is composed as follows:  
 <StartFormat> = N,1,0.00,0.00  
 <RepeatFormat<sub>i</sub>> = (1,M(i),1.00, $h_i$ [ $w_{i1}$ ,1.00], [ $w_{i2}$ ,1.00] ... [ $w_{iM(i)}$ ,1.00])
- For a vertical layout with N columns, each of width  $w_i$  ( $i = 1 \dots N$ ) and filled with  $M(i)$  diagrams with independent heights  $h_{ij}$  ( $j = 1, 2 \dots M(i)$ ), the data string is composed as follows:  
 <StartFormat> = 1,N,0.00,0.00  
 <RepeatFormat<sub>i</sub>> = (M(i),1, $w_i$ ,1.00,[1.00, $h_{i1}$ ], [1.00, $h_{i2}$ ] ... [1.00, $h_{iM(i)}$ ])

**Note:** The maximum number of diagrams in a layout is 256.

**Parameters:**

<LayoutData> String parameter defining the number of diagrams and their position (executable format); see above.

**Example:** See [Creating Diagrams](#)

**Manual operation:** See "[Additional Functionality: SCPI Commands](#)" on page 325

**DISPlay:LAYout:GRID** <Rows>, <Columns>

Defines the number of rows and columns if **DISPlay:LAYout GRID** is set.

**Parameters:**

<Rows> Range: 1 to 16  
 \*RST: 1

<Columns> Range: 1 to 16  
 \*RST: 1

**Example:**

**DISPlay:LAYout GRID**

Select the split type where the diagrams are arranged in rows and columns.

**DISPlay:LAYout:GRID 2,2**

Arrange 4 diagrams in two rows and two columns.

**Manual operation:** See ["Split Type / Diagrams / Rows / Columns"](#) on page 325

---

**DISPlay:LAYout:JOIN** <MainLayoutId>, <DiagramNumber>, <SubLayoutId>

Creates a nested layout, inserting a sub-layout into one of the diagrams of a main layout. Main layout and sub-layout must be defined previously, preferably using [DISPlay:LAYout:DEFine](#).

**Note:** The maximum number of joined levels within a layout is 16.

**Setting parameters:**

<MainLayoutId> Integer value 1, 2 ...  
Current number of main layout, as defined by [DISPlay:LAYout:DEFine](#).

<DiagramNumber> Integer value 1, 2 ...  
Diagram number in the main layout

<SubLayoutId> Integer value 1, 2 ...  
Current number of sub-layout, as defined by [DISPlay:LAYout:DEFine](#).

\*RST: n/a

**Example:** See [Creating Diagrams](#)

**Usage:** Setting only

**Manual operation:** See ["Additional Functionality: SCPI Commands"](#) on page 325

---

**DISPlay:MENU:KEY:ACTion:CATalog?**

Displays the identifiers of the available dialog opener actions as a comma-separated list of strings.

Use [DISPlay:MENU:KEY:EXECute](#) to open one of the dialogs.

**Example:** `DISPlay:MENU:KEY:ACTion:CATalog?`  
returns the list of identifiers, from  
' :Cal:Activation:CalManager ' to  
' :Trigger:SweepControl:RestartManager '

**Usage:** Query only

---

**DISPlay:MENU:KEY:EXECute** <OpenerID>

Opens the dialog identified by <OpenerID>.

Use [DISPlay:MENU:KEY:ACTion:CATalog?](#) to display the available opener IDs.

**Note** that no error is generated if a valid <OpenerID> is specified but the dialog cannot be opened for any other reason.

**Setting parameters:**

<OpenerID> Identifier of a dialog opener

**Example:** `*RST; DISP:MENU:KEY:EXECute ':Cal:Calibration:StartCalUnit'`  
 Activates the [Calibration Unit Wizard](#) (provided that a cal unit is connected).

**Usage:** Setting only

**Tip:** When working with the [Chapter 5.1.2, "GPIB Explorer"](#), on page 360, switch to raw mode ("Options > Raw mode" in the IECWIN32 GUI) before executing this command.

### **DISPlay:MENU:KEY:SELEct <TabID>**

Activates the softtool tab with identifier <TabID>.

Use [DISPlay:MENU:KEY:TOOL:CATalog?](#) to display the available identifiers.

**Note** that no error is generated if a valid <TabID> is specified but the tab cannot be activated for any other reason.

#### **Setting parameters:**

<TabID> Identifier of a softtool tab

**Example:** `*RST; DISP:MENU:KEY:SEL ':Cal:Activation'`  
 Activates the [Calibration > Start Cal](#) softtool tab.

**Usage:** Setting only

**Tip:** When working with the [Chapter 5.1.2, "GPIB Explorer"](#), on page 360, switch to raw mode ("Options > Raw mode" in the IECWIN32 GUI) before executing this command.

### **DISPlay:MENU:KEY:TOOL:CATalog?**

Displays the identifiers of the available softtool tabs as a comma-separated list of strings.

Use [DISPlay:MENU:KEY:SELEct](#) to activate one of the tabs.

**Example:** `DISPlay:MENU:KEY:TOOL:CATalog?`  
 returns the list of identifiers, from `':Applic:ExternalTools'` to `':Trigger:SweepControl'`

**Usage:** Query only

### **DISPlay:RFSize <RelFontSize>**

Defines the size of the fonts in the diagram on a relative scale.

#### **Parameters:**

<RelFontSize> Relative font size  
 Range: 80 % to 170 %  
 \*RST: 100 %  
 Default unit: percent



**Example:** `*RST; :DISP:RFS 80`  
Use smaller fonts to gain more space for the traces in the diagram.

**Manual operation:** See "[Font Size](#)" on page 328

### DISPlay[:WINDow<Wnd>]:CATalog?

Returns the numbers and names of all diagrams in the current recall set.

The response is a string containing a comma-separated list of diagram area numbers and names, see example below. If all diagram areas have been deleted, the response is an empty string ("").

**Suffix:**  
<Wnd> Number of a diagram. This suffix is ignored; the command returns a list of all diagrams.

**Example:** `*RST; :DISP:WIND2:STAT ON`  
Create diagram no. 2.  
`DISP:WIND2:NAME 'S11 Test Diagram'`  
Assign a name to the new diagram.  
`DISP:CAT?`  
Query all diagrams and their names. As a default diagram no. 1 is created upon \*RST, the response is '1,1,2,S11 Test Diagram'. The first diagram is not named; its default name is equal to the diagram number.  
`CALC:PAR:SDEF 'Win2_Tr1', 'S11'`  
Create a trace named Win2\_Tr1 to measure the input reflection coefficient  $S_{11}$ .  
`DISP:WIND2:TRAC9:FEED 'Win2_Tr1'`  
Display the generated trace in diagram area no. 2, assigning the trace number 9 to it.  
`DISP:WIND2:TRAC:CAT?`  
Query all traces in diagram area no. 2. The response is '9,Win2\_Tr1'.

**Usage:** Query only

**Manual operation:** See "[Title](#)" on page 321

### DISPlay[:WINDow<Wnd>]:MAXimize <Boolean>

Maximizes all diagram areas in the active recall set or restores the previous display configuration.

**Suffix:**  
<Wnd> Number of the diagram area to become the active diagram area. DISPlay[:WINDow<Wnd>]:MAXimize acts on all diagrams of the current recall set, however, the diagram no. <Wnd> is displayed on top of the others.

**Parameters:**

<Boolean> ON | OFF - maximize all diagram areas or restore the previous display configuration.

\*RST: OFF

**Example:**

\*RST; :DISP:WIND2:STAT ON

Create diagram areas no. 1 (with default trace) and 2 (with no trace).

DISP:WIND2:MAXimize ON

Maximize the diagram areas, placing area no. 2 on top.

**Manual operation:** See ["Maximize"](#) on page 321

**DISPlay[:WINDow<Wnd>]:OVERview[:STATe] <Boolean>**

Enables the zoom function with an additional overview window for the diagram no. <Wnd> or removes the overview window from a diagram.

**Suffix:**

<Wnd> Number of the zoomed diagram area

**Parameters:**

<Boolean> ON – activate the zoom window with overview window

OFF – remove the overview window

\*RST: OFF

**Example:**

See [DISPlay\[:WINDow<Wnd>\]:TRACe<WndTr>:ZOOM\[:STATe\]](#)

**Manual operation:** See ["Overview Select"](#) on page 161

**DISPlay[:WINDow<Wnd>]:NAME <Name>**

Defines a name for diagram area <Wnd>. The name appears in the list of diagram areas, to be queried by [DISPlay\[:WINDow<Wnd>\]:CATalog?](#).

**Suffix:**

<Wnd> Number of the diagram area.

**Parameters:**

<Name> String variable for the name.

**Example:**

See [DISPlay\[:WINDow<Wnd>\]:CATalog?](#)

**Manual operation:** See ["Title"](#) on page 321

**DISPlay[:WINDow<Wnd>][:STATe] <Boolean>**

Creates or deletes a diagram area, identified by its area number <Wnd>.

**Suffix:**

<Wnd> Number of the diagram area to be created or deleted.

**Parameters:**

<Boolean> ON | OFF - creates or deletes diagram area no. <Wnd>.  
 \*RST: -

**Example:**

```
CALC4:PAR:SDEF 'Ch4Tr1', 'S11'
```

Create channel 4 and a trace named Ch4Tr1 to measure the input reflection coefficient  $S_{11}$ .

```
DISP:WIND2:STAT ON
```

Create diagram area no. 2.

```
DISP:WIND2:TRAC9:FEED 'CH4TR1'
```

Display the generated trace in diagram area no. 2, assigning the trace number 9 to it.

**Manual operation:** See ["Add Trace + Diag"](#) on page 164

**DISPlay[:WINDow<Wnd>]:TITLe:DATA <Title>**

Defines a title for diagram area <Wnd>.

**Suffix:**

<Wnd> Number of the diagram area.

**Parameters:**

<Title> String variable for the title. The length of the title is practically unlimited but should be kept short enough to be displayed in the diagrams.

**Example:**

```
*RST; :DISP:WIND:TITL:DATA 'S21 Test Diagram'
```

Define a title for the default diagram area. The title is displayed below the top of the diagram area.

```
DISP:WIND:TITL OFF; TITL:DATA?
```

Hide the title. The title is no longer displayed but still defined so it can be displayed again.

**Manual operation:** See ["Title"](#) on page 321

**DISPlay[:WINDow<Wnd>]:TITLe[:STATe] <Boolean>**

Displays or hides the title for area number <Wnd>, defined by means of `DISPlay:WINDow<Wnd>:TITLe:DATA`.

**Suffix:**

<Wnd> Number of the diagram area.

**Parameters:**

<Boolean> ON | OFF - displays or hides the title.  
 \*RST: ON

**Example:**

See `DISPlay[:WINDow<Wnd>]:TITLe:DATA`

**Manual operation:** See ["Title"](#) on page 321

**DISPlay[:WINDow<Wnd>]:TRACe<WndTr>:CATalog?**

Returns the numbers and names of all traces in diagram area no. <Wnd>.

**Suffix:**

<Wnd>                      Number of a diagram area.

<WndTr>                    Trace number used to distinguish the traces of the same diagram area <Wnd>. This suffix is ignored; the command returns a list of all traces.

**Example:**                See [DISPlay\[:WINDow<Wnd>\]:CATalog?](#)

**Usage:**                    Query only

**Manual operation:**    See "Title" on page 321

**DISPlay[:WINDow<Wnd>]:TRACe<WndTr>:DElete**

Releases the assignment between a trace and a diagram area, as defined by means of [DISPlay\[:WINDow<Wnd>\]:TRACe<WndTr>:FEED<TraceName>](#) and expressed by the <WndTr> suffix. The trace itself is not deleted; this must be done via [CALCulate<Ch>:PARAMeter:DElete<TraceName>](#).

**Suffix:**

<Wnd>                      Number of an existing diagram area (defined by means of [DISPlay\[:WINDow<Wnd>\]:STATe\]ON](#)).

<WndTr>                    Trace number used to distinguish the traces of the same diagram area <Wnd>.

**Example:**

```
CALC4:PAR:SDEF 'Ch4Tr1', 'S11'
```

Create channel 4 and a trace named Ch4Tr1 to measure the input reflection coefficient  $S_{11}$ .

```
DISP:WIND2:STAT ON
```

Create diagram area no. 2.

```
DISP:WIND2:TRAC9:FEED 'CH4TR1'
```

Display the generated trace in diagram area no. 2, assigning the trace number 9 to it.

```
DISP:WIND2:TRAC9:DElete
```

Release the assignment between trace no. 9 and window no. 2. The trace can still be referenced with its trace name Ch4Tr1.

**Usage:**                    Event

**DISPlay[:WINDow<Wnd>]:TRACe<WndTr>:EFEed <TraceName>**

Assigns an existing trace ([CALCulate<Ch>:PARAMeter:SDEFine<TraceName>](#)) to a diagram area <Wnd>, and displays the trace. Use [DISPlay\[:WINDow<Wnd>\]:TRACe<WndTr>:FEED](#) to assign the trace to a diagram area using a numeric suffix (e.g. in order to use the [DISPlay\[:WINDow<Wnd>\]:TRACe<WndTr>:Y:OFFSet](#) command).

**Tip:** You can open the "Trace Manager" dialog to obtain an overview of all channels and traces, including the traces that are not displayed.

**Suffix:**

<Wnd> Number of an existing diagram area (defined by means of `DISPlay[:WINDow<Wnd>][:STATe]ON`).

<WndTr> Trace number. This suffix is ignored; the trace is referenced by its name.

**Setting parameters:**

<TraceName> String parameter for the trace name, e.g. 'Trc4'.

**Example:**

```
CALC4:PAR:SDEF 'Ch4Tr1', 'S11'
```

Create channel 4 and a trace named Ch4Tr1 to measure the input reflection coefficient  $S_{11}$ .

```
DISP:WIND2:STAT ON
```

Create diagram area no. 2.

```
DISP:WIND2:TRAC:EFE 'CH4TR1'
```

Display the generated trace in diagram area no. 2. No trace number is assigned.

**Usage:** Setting only

**Manual operation:** See "Add" on page 166

**DISPlay[:WINDow<Wnd>]:TRACe<WndTr>:FEED <TraceName>**

Assigns an existing trace (`CALCulate<Ch>:PARAmeter:SDEFine`) to a diagram area, using the <WndTr> suffix, and displays the trace. Use `DISPlay[:WINDow<Wnd>]:TRACe<WndTr>:EFEEd` to assign the trace to a diagram area without using a numeric suffix.

**Tip:** A trace can be assigned to a diagram only once. If a attempt is made to assign the same trace a second time (e.g. by typing `DISP:WIND2:TRAC8:FEED 'CH4TR1'` after executing the program example below) an error message -114, "Header suffix out of range" is generated. You can open the "Trace Manager" dialog to obtain an overview of all channels and traces, including the traces that are not displayed.

**Suffix:**

<Wnd> Number of an existing diagram area (defined by means of `DISPlay[:WINDow<Wnd>][:STATe]ON`).

<WndTr> Trace number used to distinguish the traces of the same diagram area <Wnd>.

**Parameters:**

<TraceName> String parameter for the trace name, e.g. 'Trc4'.

**Example:** `CALC4:PAR:SDEF 'Ch4Tr1', 'S11'`  
 Create channel 4 and a trace named Ch4Tr1 to measure the input reflection coefficient  $S_{11}$ .  
`DISP:WIND2:STAT ON`  
 Create diagram area no. 2.  
`DISP:WIND2:TRAC9:FEED 'CH4TR1'`  
 Display the generated trace in diagram area no. 2, assigning the trace number 9 to it.

**Manual operation:** See ["Add Trace"](#) on page 163

---

**DISPlay[:WINDow<Wnd>]:TRACe<WndTr>:SHOW <TraceName>[, <Boolean>]**

Displays or hides an existing trace, identified by its trace name <Trace\_Name>, or a group of traces.

**Tip:** You can open the trace manager to obtain an overview of all channels and traces, including the traces that are not displayed.

**Suffix:**

<Wnd> Number of a diagram area. This suffix is ignored; the command affects traces in all diagram areas.

<WndTr> Trace number. This suffix is ignored; the trace is referenced by its name.

**Parameters:**

<TraceName> DALL – all data traces  
 MALL – all memory traces  
 <string> – single trace identified by its trace name (string parameter), e.g. 'Trc4'.

<Boolean> ON | OFF – display or hide traces.

**Example:** `*RST; :DISP:TRAC:SHOW? 'Trc1'`  
 Reset the analyzer, creating the default trace 'Trc1'. The trace is displayed; the query returns 1.

`CALC4:PAR:SDEF 'Ch4Tr1', 'S11'`

Create channel 4 and a trace named Ch4Tr1 to measure the input reflection coefficient  $S_{11}$ .

`DISP:WIND2:STAT ON; :DISP:WIND2:TRAC:FEED 'CH4TR1'`

Create diagram area no. 2 and display the generated trace in the diagram area.

`DISP:TRAC:SHOW DALL, OFF`

Hide both traces in both diagrams.

`DISP:TRAC:SHOW? DALL`

Query whether all data traces are displayed. The response 0 means that at least one trace is hidden.

**Manual operation:** See ["Show <Destination>"](#) on page 169

**DISPlay[:WINDow<Wnd>]:TRACe<WndTr>:X:OFFSet <StimulusOffset>**

Shifts the trace <WndTr> in horizontal direction, leaving the positions of all markers unchanged.

**Suffix:**

<Wnd>	Number of an existing diagram area (defined by means of <a href="#">DISPlay[:WINDow&lt;Wnd&gt;][:STATe]ON</a> ).
<WndTr>	Existing trace number, assigned by means of <a href="#">DISPlay[:WINDow&lt;Wnd&gt;]:TRACe&lt;WndTr&gt;:FEED</a> .

**Parameters:**

<StimulusOffset>	Stimulus offset value. The range and unit depends on the sweep type. Default unit: NN
------------------	---

**Example:**

```
*RST; :DISP:WIND:TRAC:X:OFFS 1MHZ; :DISP:WIND:
TRAC:Y:OFFS 10
```

Create the default trace and shift it horizontally by 1 MHz, vertically by 10 dB.

**Manual operation:** See "[Shift Trace > Stimulus](#)" on page 188

**DISPlay[:WINDow<Wnd>]:TRACe<WndTr>:Y:OFFSet <MagnitudeFactor>[, <PhaseFactor>, <RealPart>, <ImaginaryPart>]**

Modifies all points of the trace <WndTr> by means of an added and/or a multiplied complex constant. The response values M of the trace are transformed according to:

**Suffix:**

<Wnd>	Number of an existing diagram area (defined by means of <a href="#">DISPlay[:WINDow&lt;Wnd&gt;][:STATe]ON</a> ).
<WndTr>	Existing trace number, assigned by means of <a href="#">DISPlay[:WINDow&lt;Wnd&gt;]:TRACe&lt;WndTr&gt;:FEED</a> .

**Parameters:**

<MagnitudeFactor>	Multiplied magnitude factor Range: -300 dB to + 300 dB *RST: 0 dB Default unit: dB
<PhaseFactor>	Multiplied phase factor, optional for setting command but returned by query Range: -3.4*1038 deg to +3.4*1038 deg *RST: 0 deg Default unit: deg
<RealPart>	Real and imaginary part of added complex constant, optional for setting command but returned by query Range: -3.4*1038 to +3.4*1038 *RST: 0

<ImaginaryPart>

**Example:** \*RST; :DISP:WIND:TRAC:X:OFFS 1MHZ; :DISP:WIND:TRAC:Y:OFFS 10  
 Create the default trace and shift it horizontally by 1 MHz, vertically by 10 dB.  
 DISP:WIND:TRAC:Y:OFFS?  
 Query all response offset values. The response is 10, 0, 0, 0.

**Manual operation:** See "[Shift Trace > Mag / Phase / Real / Imag](#)" on page 188

**DISPlay[:WINDow<Wnd>]:TRACe<WndTr>:Y[:SCALE]:AUTO <Activate>[, <TraceName>]**

Displays the entire trace in the diagram area, leaving an appropriate display margin. The trace can be referenced either by its number <WndTr> or by its name <TraceName>.

**Suffix:**

<Wnd> Number of an existing diagram area (defined by means of [DISPlay\[:WINDow<Wnd>\]\[:STATe\]ON](#)). This suffix is ignored if the optional <TraceName> parameter is used.

<WndTr> Existing trace number, assigned by means of [DISPlay\[:WINDow<Wnd>\]:TRACe<WndTr>:FEED](#). This suffix is ignored if the optional <TraceName> parameter is used.

**Setting parameters:**

<Activate> ONCE  
 Activate the autoscale function.

<TraceName> Optional string parameter for the trace name, e.g. 'Trc4'. If this optional parameter is present, both numeric suffixes are ignored (trace names must be unique across different channels and windows).

**Example:** \*RST; DISP:WIND:TRAC:Y:PDIV?; RLEV?  
 Query the value between two grid lines and the reference value for the default trace. The response is 10;0.  
 DISP:WIND:TRAC:Y:AUTO ONCE; PDIV?; RLEV?  
 or:  
 DISP:WIND:TRAC:Y:AUTO ONCE, 'Trc1'; PDIV?;  
 RLEV?  
 Autoscale the default trace and query the scaling parameters again. In general both values have changed.

**Usage:** Setting only

**Manual operation:** See "[Auto Scale Trace](#)" on page 158



---

**DISPlay[:WINDow<Wnd>]:TRACe<WndTr>:Y[:SCALE]:PDIVision <VerticalDiv>[, <TraceName>]**

Sets the value between two grid lines (value “per division”) for the diagram area <Wnd>. When a new PDIVision value is entered, the current RLEVel is kept the same, while the top and bottom scaling is adjusted for the new PDIVision value.

**Suffix:**

<Wnd> Number of an existing diagram area (defined by means of [DISPlay\[:WINDow<Wnd>\]\[:STATE\]ON](#)). This suffix is ignored if the optional <TraceName> parameter is used.

<WndTr> Existing trace number, assigned by means of [DISPlay\[:WINDow<Wnd>\]:TRACe<WndTr>:FEED](#). This suffix is ignored if the optional <TraceName> parameter is used.

**Parameters:**

<VerticalDiv> Value and unit for the vertical diagram divisions. Range and unit depend on the measured quantity, see ["Units for DISPlay... commands"](#) on page 510.

Default unit: NN

<TraceName> Optional string parameter for the trace name, e.g. 'Trc4'. If this optional parameter is present, both numeric suffixes are ignored (trace names must be unique across different channels and windows).

**Example:**

```
CALC4:PAR:SDEF 'Ch4Tr1', 'S11'
```

Create channel 4 and a trace named Ch4Tr1 to measure the input reflection coefficient  $S_{11}$ .

```
DISP:WIND2:STAT ON
```

Create diagram area no. 2.

```
DISP:WIND2:TRAC9:FEED 'CH4TR1'
```

Display the generated trace in diagram area no. 2, assigning the trace number 9 to it.

```
DISP:WIND2:TRAC9:Y:PDIV 5
```

or:

```
DISP:WIND2:TRAC:Y:PDIV 5, 'CH4TR1'
```

Set the value per division to 5 dB.

**Manual operation:** See ["Scale/Div"](#) on page 159

---

**DISPlay[:WINDow<Wnd>]:TRACe<WndTr>:Y[:SCALE]:RLEVel <RefLevel>[, <TraceName>]**

Sets the reference level (or reference value) for a particular displayed trace. Setting a new reference level does not affect the value of PDIVision. The trace can be referenced either by its number <WndTr> or by its name <TraceName>.

<b>Suffix:</b>	
<Wnd>	Number of an existing diagram area (defined by means of <code>DISPlay[:WINDow&lt;Wnd&gt;][:STATe]ON</code> ). This suffix is ignored if the optional <TraceName> parameter is used.
<WndTr>	Existing trace number, assigned by means of <code>DISPlay[:WINDow&lt;Wnd&gt;]:TRACe&lt;WndTr&gt;:FEED</code> . This suffix is ignored if the optional <TraceName> parameter is used.
<b>Parameters:</b>	
<RefLevel>	Value and unit for the reference level (or reference value, if the trace does not show a level). Range and unit depend on the measured quantity, see "Units for DISPlay... commands" on page 510. Default unit: NN
<TraceName>	Optional string parameter for the trace name, e.g. 'Trc4'. If this optional parameter is present, both numeric suffixes are ignored (trace names must be unique across different channels and windows).
<b>Example:</b>	<pre>CALC4:PAR:SDEF 'Ch4Tr1', 'S11'</pre> <p>Create channel 4 and a trace named Ch4Tr1 to measure the input reflection coefficient <math>S_{11}</math>.</p> <pre>DISP:WIND2:STAT ON</pre> <p>Create diagram area no. 2.</p> <pre>DISP:WIND2:TRAC9:FEED 'CH4TR1'</pre> <p>Display the generated trace in diagram area no. 2, assigning the trace number 9 to it.</p> <pre>DISP:WIND2:TRAC9:Y:RLEV -10</pre> <p>or:</p> <pre>DISP:WIND2:TRAC:Y:RLEV -10, 'CH4TR1'</pre> <p>Change the reference level to -10 dB.</p>
<b>Manual operation:</b>	See "Ref Value" on page 159

---

**DISPlay[:WINDow<Wnd>]:TRACe<WndTr>:Y[:SCALE]:RPOSition <RefPosition>[, <TraceName>]**

Sets the point on the y-axis to be used as the reference position as a percentage of the length of the y-axis. The reference position is the point on the y-axis which should equal the `RLEVel`.

<b>Suffix:</b>	
<Wnd>	Number of an existing diagram area (defined by means of <code>DISPlay[:WINDow&lt;Wnd&gt;][:STATe]ON</code> ). This suffix is ignored if the optional <TraceName> parameter is used.
<WndTr>	Existing trace number, assigned by means of <code>DISPlay[:WINDow&lt;Wnd&gt;]:TRACe&lt;WndTr&gt;:FEED</code> . This suffix is ignored if the optional <TraceName> parameter is used.

**Parameters:**

<RefPosition>	Value of the reference position in percent. The top of the y-axis is defined to have a reference position of 100%, while the bottom of the y-axis is defined to have a reference position of 0%. Range: 0% to 100% *RST: 80% Default unit: %
<TraceName>	Optional string parameter for the trace name, e.g. 'Trc4'. If this optional parameter is present, both numeric suffixes are ignored (trace names must be unique across different channels and windows).

**Example:**

```
CALC4:PAR:SDEF 'Ch4Tr1', 'S11'
```

Create channel 4 and a trace named Ch4Tr1 to measure the input reflection coefficient  $S_{11}$ .

```
DISP:WIND2:STAT ON
```

Create diagram area no. 2.

```
DISP:WIND2:TRAC9:FEED 'CH4TR1'
```

Display the generated trace in diagram area no. 2, assigning the trace number 9 to it.

```
DISP:WIND2:TRAC9:Y:RPOS 50
```

or:

```
DISP:WIND2:TRAC:Y:RPOS 50, 'CH4TR1'
```

Set the reference position to the center of the diagram area.

**Manual operation:** See ["Ref Position"](#) on page 159

```
DISPlay[:WINDow<Wnd>]:TRACe<WndTr>:Y[:SCALe]:BOTTom <LowEdge>[,  
  <TraceName>]
```

```
DISPlay[:WINDow<Wnd>]:TRACe<WndTr>:Y[:SCALe]:TOP <UppEdge>[,  
  <TraceName>]
```

These commands define the lower (bottom) and upper (top) edge of the diagram area <Wnd>.

**Suffix:**

<Wnd>	Number of an existing diagram area (defined by means of <a href="#">DISPlay[:WINDow&lt;Wnd&gt;][:STATe]ON</a> ). This suffix is ignored if the optional <TraceName> parameter is used.
<WndTr>	Existing trace number, assigned by means of <a href="#">DISPlay[:WINDow&lt;Wnd&gt;]:TRACe&lt;WndTr&gt;:FEED</a> . This suffix is ignored if the optional <TraceName> parameter is used.

**Parameters:**

<UppEdge>	Value and unit for the lower or upper diagram edge. Range and unit depend on the measured quantity, see <a href="#">"Units for DISPlay... commands"</a> on page 510. Default unit: NN
-----------	--

<TraceName> Optional string parameter for the trace name, e.g. 'Trc4'. If this optional parameter is present, both numeric suffixes are ignored (trace names must be unique across different channels and windows).

**Example:**

```
CALC4:PAR:SDEF 'Ch4Tr1', 'S11'
```

Create channel 4 and a trace named Ch4Tr1 to measure the input reflection coefficient  $S_{11}$ .

```
DISP:WIND2:STAT ON
```

Create diagram area no. 2.

```
DISP:WIND2:TRAC9:FEED 'CH4TR1'
```

Display the generated trace in diagram area no. 2, assigning the trace number 9 to it.

```
DISP:WIND2:TRAC9:Y:BOTT -40; TOP 10
```

or:

```
DISP:WIND2:TRAC:Y:BOTT -40, 'CH4TR1'; TOP 10, 'CH4TR1'
```

Scale the diagram between -40 dB and +10 dB.

**Manual operation:** See "[Max / Min](#)" on page 159

---

**DISPlay[:WINDow<Wnd>]:TRACe<WndTr>:ZOOM[:STATe] <Boolean>[, <TraceName>]**

Applies or disables the zoom function based on the current zoom window settings.

**Suffix:**

<Wnd>

Number of an existing diagram (defined by means of [DISPlay\[:WINDow<Wnd>\]\[:STATe\]ON](#)). This suffix is ignored if the optional <TraceName> parameter is used.

<WndTr>

Existing trace number, assigned by means of [DISPlay\[:WINDow<Wnd>\]:TRACe<WndTr>:FEED](#). This suffix is ignored if the optional <TraceName> parameter is used.

**Parameters:**

<Boolean>

Enable or disable the zoom. OFF also restores the original diagram size after a zoom function was applied.

OFF

<TraceName>

Optional string parameter for the trace name, e.g. 'Trc4'. If this optional parameter is present, both numeric suffixes are ignored (trace names must be unique across different channels and windows).

**Example:**                    \*RST; :DISPlay:WINDow1:TRACe:ZOOM:BOTTom -20;  
TOP +10; START 1GHz; STOP 1.5 GHz  
Define a zoom rectangle in the default diagram no. 1 ranging from -20 dB to +10 dB and from 1 GHz to 1.5 GHz.  
DISPlay:WINDow1:TRACe:ZOOM ON  
Zoom into the diagram no. 1 so that the zoom window fills the entire diagram. The actual sweep range and the stimulus values of the sweep points are not affected.  
DISPlay:WINDow1:OVERview:STATe ON  
Activate an additional overview window in the upper part of the diagram.

**Manual operation:** See ["Zoom Reset"](#) on page 161

---

**DISPlay[:WINDow<Wnd>]:TRACe<WndTr>:ZOOM:START** <LeftBorder>[, <TraceName>]

**DISPlay[:WINDow<Wnd>]:TRACe<WndTr>:ZOOM:STOP** <RightBorder>[, <TraceName>]

These commands specify the start and stop values of the zoom window (left and right border), respectively. In contrast to manual control, all or part of the zoom window may be outside the original diagram. The range of possible values depends on the R&S ZNC/ZND's frequency range; see [Chapter 6.3.15.8, "\[SENSe:\]FREQUENCY..."](#), on page 643.

**Suffix:**

<Wnd>                    Number of an existing diagram (defined by means of [DISPlay\[:WINDow<Wnd>\]\[:STATe\]ON](#)). This suffix is ignored if the optional <TraceName> parameter is used.

<WndTr>                Existing trace number, assigned by means of [DISPlay\[:WINDow<Wnd>\]:TRACe<WndTr>:FEED](#). This suffix is ignored if the optional <TraceName> parameter is used.

**Parameters:**

<RightBorder>        Left or right border of the zoom window.  
Range:                See description above.  
\*RST:                Start or stop of the analyzer's sweep range.  
Default unit: NN

<TraceName>        Optional string parameter for the trace name, e.g. 'Trc4'. If this optional parameter is present, both numeric suffixes are ignored (trace names must be unique across different channels and windows).

**Example:**                See [DISPlay\[:WINDow<Wnd>\]:TRACe<WndTr>:ZOOM\[:STATe\]](#)

**Manual operation:** See ["Max / Min / Start / Stop"](#) on page 162

---

**DISPlay[:WINDow<Wnd>]:TRACe<WndTr>:ZOOM:BOTTom** <LowEdge>[,  
<TraceName>]

**DISPlay[:WINDow<Wnd>]:TRACe<WndTr>:ZOOM:TOP** <UppEdge>[,  
<TraceName>]

These commands specify the lower and upper edge of the zoom window. In contrast to manual control, all or part of the zoom window may be outside the original diagram.

**Suffix:**

<Wnd>                    Number of an existing diagram (defined by means of [DISPlay\[:WINDow<Wnd>\]\[:STATe\]ON](#)). This suffix is ignored if the optional <TraceName> parameter is used.

<WndTr>                Existing trace number, assigned by means of [DISPlay\[:WINDow<Wnd>\]:TRACe<WndTr>:FEED](#). This suffix is ignored if the optional <TraceName> parameter is used.

**Parameters:**

<UppEdge>             Lower or upper edge of the zoom window. Range and unit depend on the measured quantity, see "[Units for DISPlay... commands](#)" on page 510.

Default unit: NN

<TraceName>          Optional string parameter for the trace name, e.g. 'Trc4'. If this optional parameter is present, both numeric suffixes are ignored (trace names must be unique across different channels and windows).

**Example:**            See [DISPlay\[:WINDow<Wnd>\]:TRACe<WndTr>:ZOOM\[:STATe\]](#)

**Manual operation:** See "[Max / Min / Start / Stop](#)" on page 162

### 6.3.7 FORMat Commands

The `FORMat...` commands select a data format for transferring numeric data (including arrays) from and to the analyzer.

[FORMat:BORDER](#).....534  
[FORMat\[:DATA\]](#).....535

---

**FORMat:BORDER** <ByteOrder>

Controls whether binary data is transferred in normal or swapped byte order.

**Parameters:**

<ByteOrder>            NORMal | SWAPped  
 SWAPped - the least significant byte is transferred first (little endian).  
 NORMal - the most significant byte is transferred first (big endian).  
 \*RST:            SWAPped (if the GPIB Language is set to PNA or HP xxxx, then the order is NORMal)

**Example:**

```
FORM:BORD NORM
Change the byte order to normal mode.
```

**Manual operation:** See "[Define \\*IDN? + \\*OPT?](#)" on page 347

**FORMat[:DATA] <TransferFormat>[, <Length>]**

Selects the format for numeric data transferred to and from the analyzer.

**Note:** The format setting is only valid for commands and queries whose description states that the response is formatted as described by FORMat [:DATA]. In particular, it affects trace data transferred by means of the TRACE: . . . system.

**Parameters:**

<TransferFormat>    ASCii | REAL  
 ASCii - numeric data is transferred as ASCII bytes. The numbers are separated by commas as specified in IEEE 488.2.  
 REAL - Data is transferred in a definite length block as IEEE floating point numbers of the specified <Length>. See [Chapter 5.2.3.5, "Block Data Format"](#), on page 370.  
**Note:** If binary data is transferred to the analyzer, the receive terminator should be set to EOI (SYSTem:COMMunicate:GPIB[:SELF]:RTERminator EOI) to avoid inadvertent interruption of the data transfer.

<Length>            The optional <Length> parameter is needed for REAL format only. It defines the length of the floating point numbers in bits. Valid values are 32 and 64.  
 \*RST:            ASCII. The default length of REAL data is 32 bits (single precision).

**Example:**

```
FORM REAL, 32
Select real data format.
SYST:COMM:GPIB:RTER EOI
Set the terminator to EOI.
(During a calibration) ... CORR:CDAT?
'REFLTRACK',1,0
Query a system error correction term. The data is transferred in a definite length block which can be written to a file; the analyzer displays the message "<no> bytes binary data received".
```

### 6.3.8 HCOPY Commands

The `HCOPY` . . . commands control the output of screen information to an external device. Part of the functionality of this system is included in the "File" menu.

<code>HCOPY:DESTination</code> .....	536
<code>HCOPY:DEvice:LANGUage</code> .....	536
<code>HCOPY:ITEM:ALL</code> .....	537
<code>HCOPY:ITEM:LOGO[:STATe]</code> .....	537
<code>HCOPY:ITEM:MLISt[:STATe]</code> .....	537
<code>HCOPY:ITEM:TIME[:STATe]</code> .....	538
<code>HCOPY:PAGE:COLor</code> .....	538
<code>HCOPY:PAGE:MARGin:BOTTom</code> .....	538
<code>HCOPY:PAGE:MARGin:LEFT</code> .....	539
<code>HCOPY:PAGE:MARGin:RIGHT</code> .....	539
<code>HCOPY:PAGE:MARGin:TOP</code> .....	539
<code>HCOPY:PAGE:ORientation</code> .....	539
<code>HCOPY:PAGE:WINDow</code> .....	540
<code>HCOPY[:IMMediate]</code> .....	540

---

#### `HCOPY:DESTination` <PrinterName>

Selects a printer name or file as destination for the screen output.

##### Parameters:

<PrinterName>	String variable containing the printer name. One of the printers accessible from your PC. The following strings are supported in addition: 'MMEM' - print to file. The file name is defined via <code>MMEMory:NAME</code> . The command <code>HCOPY:DEvice:LANGUage</code> selects the file format. 'DEFPRt' - use default printer, to be selected in the "Printers and Faxes" dialog of the Windows control panel. *RST: n/a (*RST does not overwrite the printer destination)
---------------	--

##### Example:

```
MMEM:NAME 'C:\Screenshots\PLOT1.BMP'
```

Define a printer file name (without creating the file), assuming that .BMP is the current file format (see `HCOPY:DEvice:LANGUage`).

```
HCOP:DEST 'MMEM'; :HCOP
```

Select 'Print to file' and create the printer file specified before.

**Manual operation:** See "To File..." on page 125

---

#### `HCOPY:DEvice:LANGUage` <Format>

Selects a file format for printer files. Selecting the format is recommended to ensure that the file defined via `MMEMory:NAME` can be read or imported by an external application.



**Parameters:**

<Format> BMP | PNG | JPG | PDF | SVG  
 BMP - Windows bitmap  
 JPG - JPEG bitmap  
 PNG - portable network graphics format  
 PDF - portable document format (Adobe® Systems)  
 SVG - scalable vector graphics format, XML-based  
 \*RST: n/a (\*RST does not affect the printer configuration)

**Example:**

```
HCOP:DEV:LANG BMP
Select Windows bitmap format for printer files.
MMEM:NAME 'C:\Screenshots\PLOT1.BMP'
Define a printer file name and specify an existing directory (with-
out creating the file).
HCOP:DEST 'MMEM'; :HCOP
Select 'Print to file' and create the printer file specified before.
```

**HCOPY:ITEM:ALL**

Selects the complete screen contents to be printed, including the logo ([HCOPY:ITEM:LOGO\[:STATe\]](#)), time ([HCOPY:ITEM:TIME\[:STATe\]](#)), and the marker list ([HCOPY:ITEM:MLIST\[:STATe\]](#)).

**Example:**

```
HCOP:ITEM:ALL
Select the complete information to be printed.
HCOP
Start printing.
```

**Usage:**

Event

**HCOPY:ITEM:LOGO[:STATe] <Boolean>**

Qualifies whether or not the printed output contains the logo. The default R&S logo (file `Logo.gif`) is stored in the `Resources\Images` subdirectory of the VNA program directory and can be replaced by another logo.

**Parameters:**

<Boolean> ON | OFF - logo is included or excluded.  
 \*RST: n/a (\*RST does not affect the printer configuration)

**Example:**

```
HCOP:ITEM:ALL
Select the complete information to be printed.
HCOP:ITEM:LOGO ON; :HCOP
Include the logo in the printed output and start printing.
```

**HCOPY:ITEM:MLIST[:STATe] <Boolean>**

Qualifies whether or not the printed output contains the information in the marker info field (marker list).

**Parameters:**

<Boolean> ON | OFF - marker list is included or excluded.  
 \*RST: n/a (\*RST does not affect the printer configuration)

**Example:**

```
HCOP:ITEM:ALL
Select the complete information to be printed.
HCOP:ITEM:MLIST ON; :HCOP
Include the marker list in the printed output and start printing.
```

**HCOPy:ITEM:TIME[:STATe] <Boolean>**

Qualifies whether or not the printed output contains the current date and time.

**Parameters:**

<Boolean> ON | OFF - date and time is included or excluded.  
 \*RST: n/a (\*RST does not affect the printer configuration)

**Example:**

```
HCOP:ITEM:ALL
Select the complete information to be printed.
HCOP:ITEM:TIME ON; :HCOP
Include the data and time in the printed output and start printing .
```

**HCOPy:PAGE:COLor <Boolean>**

Enables color printing.

**Parameters:**

<Boolean> ON – print with color or grayscale (depending on the printer capabilities).  
 OFF – use black-and-white printing using line styles to allow identification of different traces.  
 \*RST: n/a (\*RST does not affect the printer configuration)

**Example:**

```
HCOP:PAGE:COL OFF
Be thrifty; generate black-and-white hardcopies.
```

**HCOPy:PAGE:MARGin:BOTTom <LowMargin>**

Defines the distance between the bottom of the page and the bottom of the printed information.

**Parameters:**

<LowMargin> Lower margin  
 Range: 0.01 mm to 10000 mm  
 \*RST: n/a (\*RST does not affect the printer configuration)

**Example:**

```
HCOP:PAGE:MARG:BOTT 10; TOP 10
Set an upper and a lower margin of 1 cm.
```

**HCOPy:PAGE:MARGin:LEFT** <LeftMargin>

Defines the distance between the left edge of the page and the left edge of the printed information.

**Parameters:**

<LeftMargin> Left margin  
 Range: 0.01 mm to 10000 mm  
 \*RST: n/a (\*RST does not affect the printer configuration)

**Example:**

HCOP:PAGE:MARG:LEFT 10; RIGHT 10  
 Set an left and a right margin of 1 cm.

**HCOPy:PAGE:MARGin:RIGHT** <RightMargin>

Defines the distance between the right edge of the page and the right edge of the printed information.

**Parameters:**

<RightMargin> Right margin  
 Range: 0.01 mm to 10000 mm  
 \*RST: n/a (\*RST does not affect the printer configuration)

**Example:**

HCOP:PAGE:MARG:LEFT 10; RIGHT 10  
 Set an left and a right margin of 1 cm.

**HCOPy:PAGE:MARGin:TOP** <UppMargin>

Defines the distance between the top of the page and the top of the printed information.

**Parameters:**

<UppMargin> Upper margin  
 Range: 0.01 mm to 10000 mm  
 \*RST: n/a (\*RST does not affect the printer configuration)

**Example:**

HCOP:PAGE:MARG:BOTT 10; TOP 10  
 Set an upper and a lower margin of 1 cm.

**HCOPy:PAGE:ORientation** <Orientation>

Defines the orientation of the printed page. Switching between LANDscape and PORTrait rotates the hardcopy result by 90 degrees. No other settings are changed.

**Parameters:**

<Orientation> LANDscape | PORTrait  
 PORTrait - short edge of the paper is the top of the page.  
 LANDscape - long edge of the paper is the top of the page.  
 \*RST: n/a (\*RST does not affect the printer configuration)

**Example:**            `HCOP:PAGE:ORI LAND; :HCOP`  
                          Select landscape page orientation and start printing.

### **HCOPY:PAGE:WINDow** <PrintDiagram>

Defines how the diagrams shall be printed (using `HCOPY[:IMMEDIATE]`).

#### **Parameters:**

<PrintDiagram>    ALL | SINGLE | ACTIVE | HARDcopy | NONE  
 NONE - print no diagram at all.  
 ALL - all diagrams are printed on one page.  
 SINGLE - one diagram per page.  
 ACTIVE - print only active diagram.  
 HARDcopy - print a screenshot of the diagram area, preserving layout and colors ("real screenshot")  
 \*RST:            n/a (\*RST does not affect the printer configuration)

**Example:**            `HCOP:PAGE:WIND SING; :HCOP`  
                          Select one diagram per page and start printing.

### **HCOPY[:IMMEDIATE]**

Initializes the print according to the current `HCOPY...` configuration.

**Example:**            `HCOP:DEST '<Printer_name>'`  
                          Select the printer for the output of screen data.  
                          `HCOP`  
                          Start printing.

**Usage:**              Event

**Manual operation:** See "[Print \(<Printer>\)](#)" on page 123

## **6.3.9 INITiate Commands**

The `INITiate...` commands control the initiation of the trigger system and define the scope of the triggered measurement.

<a href="#">INITiate&lt;Ch&gt;:CONTInuous</a> .....	540
<a href="#">INITiate:CONTInous:ALL</a> .....	541
<a href="#">INITiate[:IMMEDIATE]:ALL</a> .....	542
<a href="#">INITiate&lt;Ch&gt;[:IMMEDIATE][:DUMMy]</a> .....	542
<a href="#">INITiate&lt;Ch&gt;[:IMMEDIATE]:SCOPE</a> .....	543

### **INITiate<Ch>:CONTInuous** <Boolean>

Qualifies whether the analyzer measures in single sweep or in continuous sweep mode.

<b>Suffix:</b>	
<Ch>	Channel number. This suffix is ignored in the "ZVR" and "ZVABT" compatibility modes ( <code>SYSTem:LANGuage 'ZVR'   'ZVABT'</code> ).
<b>Parameters:</b>	
<Boolean>	<p>ON - the analyzer measures continuously, repeating the current sweep.</p> <p>OFF - the measurement is stopped after the number of sweeps defined via <code>[SENSe&lt;Ch&gt;:]SWEep:COUNT</code>. <code>INITiate&lt;Ch&gt;[:IMMediate][:DUMMy]</code> initiates a new measurement cycle.</p>
<b>Example:</b>	<pre>*RST:      ON</pre> <p><code>*RST; :CALC2:PAR:SDEF 'TRC2','S11'</code>  <code>DISPlay:WINDow:TRACe2:FEED 'Trc2'</code>  Reset the analyzer to create the default channel no. 1 and default trace. Create a second trace and display the trace. Both traces are measured continuously.</p> <pre>INIT1:CONT OFF</pre> <p>Activate single sweep mode for the first channel. The measurement in channel no. 1 is stopped after the current sweep. Channel no. 2 is still measured continuously.</p> <pre>INIT1</pre> <p>Activate a new (single) sweep in channel no. 1. Channel no. 2 is still measured continuously.</p> <pre>INIT:CONT:ALL OFF</pre> <p>Activate single sweep mode for all channels. The measurement in channel no. 2 is also stopped after the current sweep.</p> <pre>INIT:ALL</pre> <p>Re-start a single sweep in both channels.</p>
<b>Example:</b>	<p>Alternative settings using the R&amp;S ZVAB compatibility mode:</p> <pre>*RST; :SYSTem:LANGuage 'ZVABT'</pre> <pre>*RST; :INIT:CONT OFF</pre> <p>Activate single sweep mode for all channels (including channel no. 2 created later).</p> <pre>INIT:SCOP SING</pre> <p>State that a single sweep will be performed in the active channel.</p> <pre>CALC2:PAR:SDEF 'TRC2','S11'; :INIT2</pre> <p>Create channel no. 2 with a new trace and start a single sweep in channel no. 2. Start a single sweep in the second channel.</p>
<b>Manual operation:</b>	See " <a href="#">Continuous / Single</a> " on page 249

---

**INITiate:CONTinuous:ALL** <Boolean>

Qualifies whether the analyzer measures in single sweep or in continuous sweep mode.

This command is not supported in the "ZVR" or "ZVABT" compatibility modes.

**Parameters:**

<Boolean> ON - the analyzer measures continuously in all channel, repeating the current sweep. The query returns ON (1) if at least one channel is measured continuously.  
 OFF - the measurement is stopped after the number of sweeps defined via `[SENSe<Ch>:]SWEep:COUNT`. `INITiate<Ch>[:IMMediate][:DUMMy]` initiates a new measurement cycle.  
 \*RST: ON

**Example:** See `INITiate<Ch>:CONTinuous`

**Manual operation:** See "All Channels Continuous / on Hold" on page 250

**INITiate[:IMMediate]:ALL**

Starts a new single sweep sequence in all channels. This command is available in single sweep mode only (`INITiate:CONTinuous:ALL OFF`). The data of the last sweep (or of previous sweeps, see [Retrieving the Results of Previous Sweeps](#)) can be read using `CALCulate<Chn>:DATA:NSWeep:FIRSt? SDATa, <count>`.

This command is not supported in the "ZVR" or "ZVABT" compatibility modes.

**Note:** In contrast to all other commands of the analyzer, the `INITiate<Ch>[:IMMediate]...` commands have been implemented for overlapped execution; see [Chapter 5.4, "Command Processing"](#), on page 375.

**Example:** See `INITiate<Ch>:CONTinuous`

**Usage:** Event

**Manual operation:** See "Restart Sweep" on page 250

**INITiate<Ch>[:IMMediate][:DUMMy]**

Starts a new single sweep sequence. This command is available in single sweep mode only (`INITiate<Ch>:CONTinuousOFF`). The data of the last sweep (or previous sweeps, see [Chapter 7.2.4.3, "Retrieving the Results of Previous Sweeps"](#), on page 790) can be read using `CALCulate<Chn>:DATA:NSWeep:FIRSt? SDATa, <count>`.

**Note:** In contrast to all other commands of the analyzer, the `INITiate<Ch>[:IMMediate]...` commands have been implemented for overlapped execution; see [Chapter 5.4, "Command Processing"](#), on page 375.

**Suffix:**

<Ch> Channel number. If the channel number does not exist the analyzer returns an error message. If the "ZVR" or "ZVABT" compatibility mode is active and `INITiate<Ch>[:IMMediate]:SCOPEALL` is selected, this suffix is ignored.

**Example:** See `INITiate<Ch>:CONTinuous`

**Usage:** Event

**Manual operation:** See "Restart Sweep" on page 250

---

### INITiate<Ch>[:IMMediate]:SCOPE <Scope>

Selects the scope of the single sweep sequence. The setting is applied in single sweep mode only (INITiate<Ch>:CONTinuousOFF).

This command is needed in the "ZVR" and "ZVABT" compatibility modes only (SYSTem:LANGuage 'ZVR' | 'ZVABT').

**Suffix:**

<Ch> Channel number. The channel is ignored because the command affects all channels.

**Parameters:**

<Scope> ALL | SINGLE  
 INITiate<Ch>[:IMMediate][:DUMMy] starts a single sweep in all channels or in the referenced channel <Ch> only.

**Example:** See INITiate<Ch>:CONTinuous

**Manual operation:** See "Sweep All Channels" on page 252

## 6.3.10 INSTRument Commands

The INSTRument... commands select or query particular resources (SCPI: logical instruments) of the analyzer.

INSTRument:NSElect.....	543
INSTRument:PORT:COUNT?.....	543
INSTRument:TPORT:COUNT?.....	544

---

### INSTRument:NSElect <Channel>

Selects a channel as the active channel.

**Parameters:**

<Channel> Number of the channel to be activated. The channel must be created before using CONFigure:CHANnel<Ch>[:STATe] ON.  
 Range: 1, 2, ...  
 \*RST: 1

**Example:** CONF:CHAN2:STAT ON; :INST:NSEL?  
 Create channel no. 2 and select it as the active channel. The query returns 2.

---

### INSTRument:PORT:COUNT?

Returns the number of test ports (Port 1, Port 2 ...) of the analyzer.

**Example:** INST:PORT:COUN?  
 Return the number of ports of your analyzer.

**Usage:** Query only

---

### INSTrument:TPORt:COUNT?

Returns the total number of test ports (=analyzer ports).

**Usage:** Query only

## 6.3.11 MEMory

The MEMory... commands control the loaded recall sets of the analyzer.



### Storing setups

The MEMory... commands don't affect any stored files. Use the MMEMory... commands to store and load data and to manage files stored on a mass storage device.

MEMory:CATalog?.....	544
MEMory:CATalog:COUNT?.....	544
MEMory:DEFine.....	545
MEMory:DELeTe:ALL.....	545
MEMory:DELeTe[:NAME].....	545
MEMory:SELeCt.....	545

---

### MEMory:CATalog?

Returns the names of all loaded recall sets.

**Example:**

```
*RST; :MEM:DEF 'SET_2'
```

Create a recall set named 'Set\_2' and make it the active recall set.

```
MEM:CAT?
```

Query all recall sets. The response is 'Set1, SET\_2'.

```
MMEM:STOR:STAT 1, 'C:\Users\Public\Documents\Rohde-Schwarz\Vna\RecallSets\Set_2.znx'
```

```
MEM:DEL 'Set_2.znx'
```

Store the active recall set Set\_2 to a file, renaming it Set\_2.znx.  
Close the setup.

**Usage:** Query only

---

### MEMory:CATalog:COUNT?

Returns the number of loaded recall sets.

**Usage:** Query only



**MEMory:DEFine** <Name>

Creates a new recall set <Name> using default settings for the traces, channels and diagram areas. The created recall set becomes the active recall set.

**Setting parameters:**

<Name> String parameter to specify the name of the created recall set.

**Example:** See [MEMory:CATalog?](#)

**Usage:** Setting only

**Manual operation:** See "New" on page 121

**MEMory:DELete:ALL**

Deletes all loaded recall sets.

**Example:** `MEM:DEL:ALL; :MEM:CAT?`  
Delete all recall sets. The query `MEM:CAT?` returns an empty string. The local screen shows no recall set.

**Usage:** Event

**MEMory:DELete[:NAME]** <Name>

Closes the specified recall set.

**Setting parameters:**

<Name> String parameter to specify the name of the recall set to be closed.

**Example:** See [MEMory:CATalog?](#)

**Usage:** Setting only

**MEMory:SELect** <RecallSet>

Selects a recall set as the active recall set or returns the name of the active recall set.

**Parameters:**

<RecallSet> String parameter to specify the recall set.

**Example:** `*RST; :MEM:DEF 'SET_2'`  
Create a recall set named "SET\_2" and make it the active recall set.  
`MEM:SEL 'Set1'`  
Activate the default recall set "Set1".  
`MMEM:STOR:STAT 1, 'C:\Users\Public\Documents\Rohde-Schwarz\Vna\RecallSets\Set1.znx'; :MEM:DEL 'Set1.znx'`  
Store the active recall set "Set1" to a file, renaming it Set1.znx. Close the recall set.

### 6.3.12 MMEMemory Commands

The `MMEMemory...` commands provide mass storage capabilities for the analyzer.

#### Internal and external mass storage

The mass storage of the analyzer may be internal or external. The internal mass storage location is either the public folder or the instrument folder of the internal hard disk (`C:\Users\Public` or `C:\Users\Instrument`, see below). The external mass storage device can be a USB memory stick connected to one of the USB ports (mapped to any free drive letter) or a network connection.

#### File and directory names

The parameters for file names and directory names are strings. Some commands use a fixed directory; for others the file name parameter can contain the complete path including the drive name and all subdirectories, e.g. `'C:`

`\Users\Public\test.txt'` for the file named `test.txt` in the `Users\Public` subdirectory of the internal hard disk drive `C:\`. If no complete path is specified, the file location is relative to the current directory (queried with `MMEMemory:CDIRECTory`). The file name itself may contain the period as a separator for extensions.

File and directory names can be chosen according to Windows® conventions. All letters and numbers are allowed, as well as the special characters `"_"`, `"^"`, `"$"`, `"~"`, `"!"`, `"#"`, `"%"`, `"&"`, `"-"`, `"{"`, `"}"`, `"("`, `")"`, `"@"` and `"'"`. Reserved file names are `CON`, `AUX`, `COM1`, ..., `COM4`, `LPT1`, ..., `LPT3`, `NUL` and `PRN`. The use of wildcards `?` and `*` is not allowed.

#### Public folders in Windows® 7 and default file locations

In order to achieve maximum system security, most of the folders on the internal hard disk are read-only folders. Only the following folders can be changed:

- `C:\Users\Public`
- `C:\Users\Instrument`

The public and instrument folders may be used to store user data. To simplify this task, the public folder contains predefined subfolders; e.g. the subfolder

`C:\Users\Public\Documents\Rohde-Schwarz\Vna\Calibration\Kits` is intended for calibration kit data. The subfolder structure is similar to R&S ZVA/B instruments, however, the R&S ZVA/B default path `C:\Rohde&Schwarz\Nwa` is replaced by `C:\Users\Public\Documents\Rohde-Schwarz\Vna`.

<code>MMEMemory:AKAL:FACTory:CONVersion</code> .....	547
<code>MMEMemory:AKAL:USER:CONVersion</code> .....	548
<code>MMEMemory:CATalog?</code> .....	548
<code>MMEMemory:CATalog:ALL?</code> .....	549
<code>MMEMemory:CDIRECTory</code> .....	549
<code>MMEMemory:COPIY</code> .....	550
<code>MMEMemory:CKIT:INFO?</code> .....	550
<code>MMEMemory:DATA</code> .....	551
<code>MMEMemory:DELeTe</code> .....	551
<code>MMEMemory:DELeTe:CORRection</code> .....	551

MMEMory:FAVorite<FavId>.....	552
MMEMory:LOAD:CKIT.....	552
MMEMory:LOAD:CKIT:SDATa.....	553
MMEMory:LOAD:CKIT:SDATa:WLABel.....	554
MMEMory:LOAD:CKIT:UDIRectory.....	555
MMEMory:LOAD:CMAP.....	555
MMEMory:LOAD:CORRection.....	556
MMEMory:LOAD:CORRection:MERGe.....	557
MMEMory:LOAD:CORRection:RESolve.....	558
MMEMory:LOAD:CORRection:TCOefficient.....	559
MMEMory:LOAD:LIMit.....	559
MMEMory:LOAD:RIPPlE.....	561
MMEMory:LOAD:SEGMENT.....	562
MMEMory:LOAD:STATe.....	563
MMEMory:LOAD:TRACe.....	563
MMEMory:LOAD:TRACe:AUTO.....	564
MMEMory:MDIRectory.....	564
MMEMory:MOVE.....	565
MMEMory:NAME.....	565
MMEMory:RDIRectory.....	566
MMEMory:STORe:CKIT.....	566
MMEMory:STORe:CKIT:WLABel.....	567
MMEMory:STORe:CMAP.....	567
MMEMory:STORe:CORRection.....	567
MMEMory:STORe:CORRection:TCOefficient.....	568
MMEMory:STORe:LIMit.....	568
MMEMory:STORe:MARKer.....	568
MMEMory:STORe:RIPPlE.....	569
MMEMory:STORe:SEGMENT.....	569
MMEMory:STORe:STATe.....	570
MMEMory:STORe:TRACe.....	570
MMEMory:STORe:TRACe:CHANnel.....	571
MMEMory:STORe:TRACe:OPTion:PLUS.....	573
MMEMory:STORe:TRACe:OPTion:SSEParator.....	573
MMEMory:STORe:TRACe:OPTion:TABS.....	573
MMEMory:STORe:TRACe:OPTion:TRIM.....	574
MMEMory:STORe:TRACe:PORTs.....	574

---

### MMEMory:AKAL:FACTory:CONVersion <Directory>

Converts the factory calibration data of the standards in the active calibration unit (SYSTem:COMMunicate:RDEvice:AKAL:ADDRESS) to Touchstone format and copies it to the specified directory.

#### Setting parameters:

<Directory> String parameter to specify the directory.

#### Example:

```
MMEM:AKAL:FACTory:CONVersion 'C:\Users\Public\
Documents\Rohde-Schwarz\Vna\AKAL\Touchstone'
```

Convert and copy the factory calibration data of the active calibration unit to the specified (writable) directory.

**Usage:** Setting only

**Manual operation:** See "Apply/Cancel" on page 260

### **MMEMory:AKAL:USER:CONVersion** <Directory>[, <CalKitFile>]

Converts an arbitrary (e.g. user-defined) set of calibration data of the standards in the active calibration unit (`SYSTem:COMMunicate:RDEvice:AKAL:ADDRESS`) to Touchstone format and copies it to the specified directory.

#### **Setting parameters:**

<Directory> String parameter to specify the directory.

<CalKitFile> Name and (possibly) directory of the cal kit file to be used for the automatic calibration (optional string parameter):

- If the parameter is omitted, the analyzer uses the last characterized cal kit file.
- If an empty string ( ' ' ) is specified, the factory cal kit file stored in the active calibration unit (`SYSTem:COMMunicate:RDEvice:AKAL:ADDRESS`) is used. By default this file is also used in manual control.
- A cal kit file name `*.calkit` without path denotes a specific cal kit file stored in the active calibration unit.
- A cal kit file name `*.calkit` with path denotes a specific cal kit file stored in an arbitrary directory.

#### **Example:**

```
MMEM:AKAL:USER:CONV 'C:\Users\Public\
Documents\Rohde-Schwarz\Vna\AKAL\Touchstone'
Convert and copy the calibration data of the standards of the last
characterized cal kit to the specified (writable) directory.
MMEM:AKAL:USER:CONV 'C:\Users\Public\
Documents\Rohde-Schwarz\Vna\AKAL\Touchstone',
'user.calkit'
Convert and copy the calibration data of the standards of the
user-defined cal kit 'user.calkit' to the specified directory.
```

**Usage:** Setting only

**Manual operation:** See "Apply/Cancel" on page 260

### **MMEMory:CATalog?** [<Directory>]

Returns the contents of the current or of a specified directory. The directory information is returned in the following format:

```
<Used Size>, <FreeDiskSpace>{,<FileEntry>}{,<DirectoryEntry>}
```

The information elements indicate the following:

- <Used Size> – disk space in bytes used by the listed files, excluding subdirectories
- <FreeDiskSpace> – available free disk space in bytes
- <FileEntry> – file name, (blank), file size in bytes

- <DirectoryEntry> – directory name, <Dir>, (blank)

**Tip:** Use `MMEMemory:CATalog:ALL?` to query the contents of the current directory and all subdirectories.

**Query parameters:**

<Directory> String parameter to specify the directory. If the directory is omitted, the command queries the contents of the current directory, to be queried with `MMEMemory:CDIRectory?`.

**Example:**

MMEM:CAT?  
Possible response: 0, 771604480, calibration,  
<DIR>, , colorschemes, <DIR>, .....

**Usage:** Query only

**MMEMemory:CATalog:ALL? [<Directory>]**

Returns the contents of the current or of a specified directory and all subdirectories. The information is returned in the following format:

*Directory of <Directory>, <Used Size>, <FreeDiskSpace>{,<FileEntry>}{,<DirectoryEntry>}{,<Subdirectory>, <Used Size>, <FreeDiskSpace>{,<FileEntry>}{,<DirectoryEntry>}}*

See also `MMEMemory:CATalog?`.

**Tip:** Use `MMEMemory:CATalog?` to query the contents of the current directory.

**Query parameters:**

<Directory> String parameter to specify the directory path. If the directory is omitted, the command queries the contents of the current directory, to be queried with `MMEMemory:CDIRectory?`

**Example:**

MMEM:CAT:ALL?  
Possible response:  
Directory of C:\Users\Public\Documents\  
Rohde-Schwarz\Vna\,0, 2283155456,  
calibration, <DIR>, , colorschemes, <DIR>,  
, hardcopy, <DIR>, , limitlines, <DIR>, , ...

**Usage:** Query only

**MMEMemory:CDIRectory <Directory>**

Changes the default directory for mass memory storage.

**Parameters:**

<Directory> String parameter to specify the directory. If `DEFault` is used, the analyzer selects the default directory  
'C:\Users\Public\Documents\Rohde-Schwarz\Vna'.

**Example:** `MMEM:CDIR 'C:\Users\Public\NetworkService\Application Data'`  
Change to the specified directory.  
See also condensed program example in section [Path Independent RC Programs](#).

---

### **MMEMory:COPY** <SourceFile>, <NewFile>

Copies an existing file to a new file.

#### **Setting parameters:**

<SourceFile>

<NewFile> String parameters to specify the name of the file to be copied and the name of the new file.

\*RST: n/a

**Example:** `MMEM:COPY 'C:\Users\Public\Documents\Rohde-Schwarz\Vna\RecallSets\SET1.znx', 'D:Copy file Set1.znx in directory C:\Users\Public\Documents\Rohde-Schwarz\Vna\RecallSets to the external storage medium, mapped to drive D:\.'`

**Usage:** Setting only

---

### **MMEMory:CKIT:INFO?** <CalKitFile>[, <Detail>]

Queries connector type, name, label and gender of a cal kit defined in the specified cal kit file

#### **Query parameters:**

<CalKitFile> Path to the cal kit file, either absolute or relative to the current directory (see [MMEMory:CDIRectory](#))

<Detail> CONNECTor | LABEL | NAME | GENDER

If specified, the command only returns the corresponding property

#### **Return values:**

<ConnectorType>

<CalKitName>

<KitLabel>

<Gender> **1**: has a gender  
**0**: doesn't have a gender

**Usage:** Query only

**MMEMory:DATA** <Filename>[, <DataBlock>]

Loads a <DataBlock> into the file <FileName>.

**Parameters:**

<Filename>	String parameter to specify the name of the file.
<DataBlock>	<block_data> Data in IEEE488.2 block data format. The delimiter EOI must be selected to achieve correct data transfer.

**Example:** `MMEM:DATA? 'C:\Users\Public\TEST01.HCP'`  
Query the block data contained in file TEST01.HCP.

**MMEMory:DELeTe** <File>[, <Force>]

Removes a file from the specified directory.

**Setting parameters:**

<File>	Mandatory string parameter containing the path and file name of the removed file. If the path is omitted, the current directory is used (see <a href="#">MMEMory:CDIRectory</a> ).
<Force>	FORCe Optional parameter, allows you to delete read-only files, too.

**Example:** `MMEM:DEL 'C:\Users\Public\TEST01.HCP'`  
Remove file TEST01.HCP from the directory C:\Users\Public. The file must not be read-only; otherwise the additional parameter FORCe is required.

**Usage:** Setting only

**MMEMory:DELeTe:CORRection** <CalGroupName>

Deletes a system error correction data set stored in the cal pool (cal group file).

**Setting parameters:**

<CalGroupName>	String parameter to specify the name of the cal group file to be deleted. Cal group files must have the extension *.cal. The directory path must not be specified; the analyzer always uses the default cal pool directory 'C:\Users\Public\Documents\Rohde-Schwarz\Vna\Calibration\Data'.
----------------	--

**Example:** See [MMEMory:LOAD:CORRection](#)

**Usage:** Setting only

**Manual operation:** See "Pool / Delete from Pool" on page 295

**MMEMory:FAVorite<FavId> <RecallSetFile>**

Manages the list of favorite recall sets

**Suffix:**

<FavId> 1...6  
Position in the favorites list

**Parameters:**

<RecallSetFile> File path, either absolute or relative to the current directory (see [MMEMory:CDIRectory](#)). The empty string represents an empty position in the favorites list.  
Note that when a non-empty favorite is set, the target recall set must exist.

**Example:**

```
:MMEMory:CDIRectory DEFault
:MMEM:FAV1 'RecallSets\My_RecallSet1.znx'
Sets My_RecallSet1.znx at position 1 of the favorites list.
MMEM:FAV1?
Returns 'C:
\Users\Public\Documents\Rohde-Schwarz\Vna\recallsets\My_Re
MMEM:FAV1 'RecallSets\My_RecallSet2.znx'
Sets My_RecallSet2.znx as favorite 1, overwriting the previ-
ous favorite 1
MMEM:FAV1 ''
Clears position 1 of the favorites list
MMEM:FAV1?
Returns ''
```

**Manual operation:** See "[Import](#)" on page 123

**MMEMory:LOAD:CKIT <CalKitFile>**

Loads cal kit data from the specified cal kit file.

**Setting parameters:**

<CalKitFile> String parameter to specify the name and directory of the loaded cal kit file. If no path is specified the analyzer searches the current directory, to be queried with [MMEMory:CDIRectory?](#).

**Example:**

```
MMEM:LOAD:CKIT 'C:\Users\Public\Documents
\Rohde-Schwarz\Vna\Calibration\Kits\New_kit.calkit'
Load the previously created cal kit file New_kit.calkit from
the default cal kit directory.
... :MMEM:STOR:CKIT 'New_kit', 'C:
\Users\Public\Documents
\Rohde-Schwarz\Vna\Calibration\Kits\New_kit.calkit'
Store the data for the user-defined cal kit Newkit and overwrite
the cal kit file New_kit.calkit.
```

**Usage:** Setting only

**Manual operation:** See "[Import Cal Kit](#)" on page 265



**MMEMory:LOAD:CKIT:SDATa** <ConnectorType>, <CalKitName>, <StandardType>, <StandardLabel>, <TouchstoneFile>[, <FirstPort>, <SecondPort>]

Loads cal kit data for a calibration standard from a specified Touchstone file. A restriction on the port assignment may be defined in addition.

Use the newer command **MMEMory:LOAD:CKIT:SDATa:WLAbel** to be able to distinguish cal kits by label.

**Setting parameters:**

<ConnectorType>	String parameter containing the name of the connector type.
<CalKitName>	String parameter containing the name of a calibration kit available on the analyzer.
<StandardType>	MMTHrough   MFTHrough   FFTHrough   MMLine   MMLine1   MMLine2   MMLine3   MFLine   MFLine1   MFLine2   MFLine3   FFLine   FFLine1   FFLine2   FFLine3   MMATten   MFATten   FFATten   MMSNetwork   MFSNetwork   FFSNetwork   MOPen   FOPen   MSHort   FSHort   MOSHort   MOSHort1   MOSHort2   MOSHort3   FOSHort   FOSHort1   FOSHort2   FOSHort3   MREFlect   FREFlect   MMTCh   FMTCh   MSMatch   FSMatch Standard types; for a description refer to table <a href="#">Standard types and their parameters</a> .
<StandardLabel>	String parameter addressing a particular calibration standard by its label. An empty string means that no label is defined.
<TouchstoneFile>	String parameter to specify the name and directory of the Touchstone file to be loaded. A *.s1p file must be used for one-port standards, a *.s2p file for two-port standards. If no path is specified the analyzer searches the current directory, to be queried with <a href="#">MMEMory:CDIRectory?</a> . *RST: -
<FirstPort>	First port number (sufficient for one-port standards). If the port numbers are omitted, the cal kit data is valid for all ports.
<SecondPort>	Second port number, for two-port standards. If the port numbers are omitted, the cal kit data is valid for all ports.

**Example:**

```
MMEM:LOAD:CKIT:SDAT 'N 50 Ohm', 'Default Kit', MOPEN, 'Test data', 'test.s1p', 1
```

Load the file Test.s1p from the current directory in order to define the properties of an Open (m) standard in the cal kit named "Default Kit" for the N 50 Ω connector type. Assign the label "Test data" and specify that the standard data is valid for port no. 1 only.

**Usage:** Setting only

**Manual operation:** See ["Import Cal Kit"](#) on page 265

**Connector and cal kit naming conventions:**

Connector and calibration kit names must be entered as string parameters. The strings contain the connector and cal kit names used in the `Calibration Kits` dialog; a  $\Omega$  in the name must be replaced by 'Ohm', e.g.:

-'NewKit1' denotes the user-defined calibration kit "NewKit1".

-'N 50 Ohm Ideal Kit' denotes the "N 50  $\Omega$  Ideal Kit".

-'ZV-Z21 typical' denotes the cal kit "ZV-Z21 typical".

---

**MMEMory:LOAD:CKIT:SDATa:WLABel** <ConnectorType>, <CalKitName>, <KitLabel>, <StandardType>, <StandardLabel>, <TouchstoneFile>[, <FirstPort>, <SecondPort>]

Loads characterization data from the given Touchstone file; similar to existing command `MMEMory:LOAD:CKIT:SDATa` but supports cal kit addressing **by label**.

**Setting parameters:**

<ConnectorType>	String parameter containing the name of the connector type.
<CalKitName>	String parameter containing the name of a calibration kit available on the analyzer.
<KitLabel>	String parameter containing the label of a calibration kit available on the analyzer. An empty string means that no label is defined.
<StandardType>	MMTHrough   MFTHrough   FFTHrough   MMLine   MMLine1   MMLine2   MMLine3   MFLine   MFLine1   MFLine2   MFLine3   FFLine   FFLine1   FFLine2   FFLine3   MMATten   MFATten   FFATten   MMSNetwork   MFSNetwork   FFSNetwork   MOPen   FOPen   MSHort   FSHort   MOSHort   MOSHort1   MOSHort2   MOSHort3   FOSHort   FOSHort1   FOSHort2   FOSHort3   MREFlect   FRElect   MMTCh   FMTCh   MSMatch   FSMatch Standard types; for a description refer to table <a href="#">Standard types and their parameters</a> .
<StandardLabel>	String parameter addressing a particular calibration standard by its label. An empty string means that no label is defined.
<TouchstoneFile>	String parameter to specify the name and directory of the Touchstone file to be loaded. A *.s1p file must be used for one-port standards, a *.s2p file for two-port standards. If no path is specified the analyzer searches the current directory, to be queried with <code>MMEMory:CDIRECTory?</code> .
<FirstPort>	First port number (sufficient for one-port standards). If the port numbers are omitted, the cal kit data is valid for all ports.
<SecondPort>	Second port number, for two-port standards. If the port numbers are omitted, the cal kit data is valid for all ports.

**Example:** `MMEM:LOAD:CKIT:SDAT:WLAB 'N 50 Ohm', 'Default Kit', '0815', MOPEN, 'Test data', 'test.s1p', 1`  
 Load the file Test.s1p from the current directory in order to define the properties of an Open (m) standard in the cal kit "Default Kit" with label "0815" for the N 50 Ω connector type. Assign the label "Test data" and specify that the standard data is valid for port no. 1 only.

**Usage:** Setting only

**Connector and cal kit naming conventions:**

Connector and calibration kit names must be entered as string parameters. The strings contain the connector and cal kit names used in the Calibration Kits dialog; a Ω in the name must be replaced by 'Ohm', e.g.:

- 'NewKit1' denotes the user-defined calibration kit "NewKit1".

- 'N 50 Ohm Ideal Kit' denotes the "N 50 Ω Ideal Kit".

- 'ZV-Z21 typical' denotes the cal kit "ZV-Z21 typical".

---

**MMEMory:LOAD:CKIT:UDIRectory <Directory>**

Specifies the "Search Path for Additional Cal Kits and Connector Types". All cal kit files in the specified directory will be (re-)loaded automatically as predefined kits (i.e. read-only kits which cannot be modified) every time the VNA application is started.

**Parameters:**

<Directory> String parameter to specify the directory path. The directory can be created separately ([MMEMory:MDIRectory](#)). An empty string means that no cal kit files will be loaded.

**Example:**

`MMEM:LOAD:CKIT:UDIR 'C:\Users\Public\Documents\Rohde-Schwarz\Vna\Calibration\Kits\Autoload'`

Specify the directory for additionally available cal kits.

`MMEM:MDIR 'C:\Users\Public\Documents\Rohde-Schwarz\Vna\Calibration\Kits\Autoload'`

Create the specified "Autoload" directory.

`MMEM:STOR:CKIT 'New Kit 1', 'C:\Users\Public\Documents\Rohde-Schwarz\Vna\Calibration\Kits\Autoload\New Kit 1.calkit'`

Store the data for the existing, user-defined cal kit "New Kit 1" to the "Autoload" directory.

**Manual operation:** See ["Search Path for Additional Cal Kits..."](#) on page 335

---

**MMEMory:LOAD:CMAp <ColorSchemeFile>**

Loads a color scheme from a specified VNA color scheme file.

**Setting parameters:**

**<ColorSchemeFile>** String parameter to specify the name and directory of the color scheme file to be loaded. The default extension (manual control) for color scheme files is \*.ColorScheme, although other extensions are allowed.

**Example:**

```
MMEM:LOAD:CMAP 'C:\Users\Public
\Documents\Rohde-Schwarz\Vna\ColorSchemes\
Test.ColorScheme'
```

Load the previously created color scheme file

Test.ColorScheme from the default color scheme directory.

```
DISP:CMAP13:RGB 1,0,0; :DISP:CMAP14:RGB 0,1,0
```

Color the first trace red, the second trace green.

```
MMEM:STOR:CMAP 'C:\Users\Public
\Documents\Rohde-Schwarz\Vna\ColorSchemes\
Test.ColorScheme'
```

Store the data for the user-defined cal kit "Newkit" and overwrite the cal kit file New\_kit.calkit.

**Usage:** Setting only

**Manual operation:** See "Recall / Save" on page 330

**MMEMory:LOAD:CORRection <Channel>[, <CalGroupFile>]**

Applies a system error correction data set stored in the cal pool (cal group file) to channel no. <Ch>.

**Parameters:**

**<Channel>** Channel number of an existing channel. ALL applies the selected data set to all channels.

**<CalGroupFile>** String parameter to specify the name of the cal group file to be loaded. Cal group files must have the extension \*.cal. The directory path must not be specified; the analyzer always uses the default cal pool directory C:\Users\Public\Documents\Rohde-Schwarz\Vna\Calibration\Data.

**Example:**

```
MMEM:STOR:CORR 1, 'Calgroup1.cal'
```

Copy the current correction data set of channel 1 to a cal group file Calgroup1.cal.

```
CONF:CHAN2:STAT ON; :MMEM:LOAD:CORR 2, 'Calgroup1.cal'
```

Apply the stored correction data (cal group file) to channel 2.

```
MMEM:LOAD:CORR? 2
```

Query the cal group file for channel 2. Response:

```
'Calgroup1.cal'
```

```
MMEM:LOAD:CORR:RES 2, 'Calgroup1.cal'
```

Resolve the pool link between channel 2 and the cal group file.

```
MMEM:LOAD:CORR? 2
```

Query the cal group file for channel 2. Response: ''

```
MMEM:DEL:CORR 'Calgroup1.cal'
```

Delete the created cal group file.

**Manual operation:** See ["Add / Add All / Replace / Apply / Apply to All"](#) on page 295

---

**MMEMory:LOAD:CORRection:MERGe** <Channel>[, <CalGroupFile>, <CalGroupFile>...]

Merges (activates) several cal group files for channel no. <Channel> so that the query [\[SENSe<Ch>:\]CORRection:COLLect:METHod:DEFine?](#) returns a list of all merged calibration types (equivalent to the calibration pool list in the "Calibration Manager" dialog). The merged cal group files can be stored to a common filee (see example).

**Note** that the calibrations to be merged must be based on the same frequency grid (identical frequency sweep points).

**Setting parameters:**

<Channel> Channel number of an existing channel

<CalGroupFile>

<CalGroupFile> String parameters with the names of the merged cal group files. Cal group files must have the extension \*.cal. The file extensions must be specified as part of the string parameters. In contrast the directory path must not be specified; the analyzer always uses the default path  
C:\Users\Public\Documents\Rohde-Schwarz\Vna\CALibration\DATA.

**Example:**

```
SENS1:CORR:COLL:METH:DEF 'Test', FRTRans, 1, 3
Select a bidirectional transmission normalization between ports
1 and 3 as a calibration type for channel 1.
CORR:COLL:SAVE:SEL:DEF; :MMEM:STOR:CORR 1,
'P1-P3.cal'
Create a default calibration data set for the selected calibration
type and store the data to a cal group file.
SENS1:CORR:COLL:METH:DEF 'Test', FRTRans, 1, 4
Select a bidirectional transmission normalization between ports
1 and 4 as a calibration type for channel 1.
CORR:COLL:SAVE:SEL:DEF; :MMEM:STOR:CORR 1,
'P1-P4.cal'
Create a default calibration data set for the selected calibration
type and store the data to a cal group file.
CORR:COLL:METH:DEF?
Query the active calibrations for channel 1. The response is
FRTR0104 (the last data set stored).
MMEM:LOAD:CORR:
MERGE 1, 'P1-P3.cal', 'P1-P4.cal'; :CORR:COLL:
METH:DEF?
Merge the two calibration types and query the active calibrations
again. The response is FRTR0103, FRTR0104.
MMEM:STOR:CORR 1, 'Merged.cal'
Store both sets of calibration data to a common cal group file.
```

**Usage:** Setting only

**Manual operation:** See ["Add / Add All / Replace / Apply / Apply to All"](#) on page 295

---

### **MMEMory:LOAD:CORRection:RESolve** <Channel>[, <CalGroupFile>]

Resolves the pool link between channel <Channel> and a correction data set (cal group file). After resolving the pool link, the analyzer keeps the previous system error correction as a channel calibration ("Channel Cal"). A new calibration will replace the channel calibration but not overwrite the old cal group file (and not affect other channels).

#### **Setting parameters:**

<Channel> Channel number of an existing channel. ALL resolves the pool link for all channels.

<CalGroupFile> Optional string parameter to specify the name of the cal group file. Cal group files must have the extension \*.cal. The directory must not be specified; the analyzer always uses the default path C:\Users\Public\Documents\Rohde-Schwarz\Vna\Calibration\Data. If there is no link between <Ch> and the specified file, the command has no effect. If no file is specified, the command resolves any link between <Ch> and an arbitrary cal group file.

**Example:** See [MMEMory:LOAD:CORRection](#)

**Usage:** Setting only  
**Manual operation:** See ["Resolve Pool Link"](#) on page 296

---

**MMEMory:LOAD:CORRection:TCOefficient** <TraceFile>[, <Trace>]

Loads trace data from a specified power meter correction file or trace file.

**Setting parameters:**

<TraceFile> String parameter specifying the name and directory of the loaded trace file. The R&S ZNC/ZND supports power meter correction list files (\*.pmcl, generated using [MMEMory:STORe:CORRection:TCOefficient](#)), \*csv, and Touchstone (\*.s1p, \*.s2p, ...) files. If no path is specified the analyzer searches the current directory, to be queried with [MMEMory:CDIRectory?](#).  
 The file extensions \*.s<n>p, \*csv, and \*.pmcl for Touchstone, ASCII, and power meter correction list files are mandatory.  
 \*RST: n/a

<Trace> Optional string parameter: For multiport Touchstone files (\*.snp, n > 1), the parameter refers to a particular S-parameter trace ('S11', 'S12', ...). For ASCII (\*.csv) files, the parameter references a trace name in the file (case sensitive). If the parameter is omitted, the first trace in the specified file is imported.  
 This parameter is not used for power meter correction list files (\*.pmcl).  
 \*RST: n/a

**Example:** See [SOURce<Ch>:POWer<PhyPt>:CORRection:TCOefficient:CALibration](#)

**Usage:** Setting only  
**Manual operation:** See ["Import File..."](#) on page 291

---

**MMEMory:LOAD:LIMit** <TraceName>, <LimLineFile>[, <TouchstoneFile>, <StimulusOffset>, <ResponseOffset>, <LimLineType>]

Loads a limit line definition from a specified file and assigns it to a trace with a specified name. Limit lines are created using the [CALCulate<Ch>:LIMit...](#) commands.

**Note:** Limit lines can be loaded from Touchstone files (\*.s<n>p, where <n> denotes the number of ports). The optional parameters '<TouchstoneFile>', <StimulusOffset>, <ResponseOffset>, <LimLineType> are only relevant for Touchstone files. For \*.limit files, no optional parameters can be set.

**Setting parameters:**

<TraceName>	Name of an existing trace in the active recall set (string parameter). The imported limit line is assigned to this trace, irrespective of the trace information in the limit line file.
<LimLineFile>	String parameter to specify the name and directory of the limit line file to be loaded. The default extension (manual control) for limit line files is *.limit, although other extensions are allowed. If no path is specified the analyzer searches the current directory, to be queried with <code>MMEMory:CDIRectory?</code> . See also note on Touchstone files above.
<TouchstoneFile>	String parameter, selects an S-parameter from a Touchstone file. The parameter must be compatible with the file type (e.g. for one-port Touchstone files *.s1p, only the parameter name 'S11' is allowed).  *RST: 'S11' (if all optional parameters are omitted)
<StimulusOffset>	Stimulus offset for limit lines loaded from a Touchstone file. A 1 GHz offset shifts the limit line by 1 GHz in (positive) horizontal direction.  Range: Depending on the sweep range of the analyzer. *RST: 0 Default unit: NN
<ResponseOffset>	Response offset for limit lines loaded from a Touchstone file. A 1 dB offset shifts the limit line by 1 dB in (positive) vertical direction.  Range: Depending on the measured quantity. *RST: 0 Default unit: NN
<LimLineType>	LMIN   LMAX   OFF Limit line type : LMAX - upper limit line LMIN - lower limit line OFF - limit line off  *RST: LMAX (if all optional parameters are omitted)



**Example:** Assume that the current recall set contains two traces named Trc1 and Trc2, respectively, and that limit lines have been defined for Trc1.

```
MMEM:STOR:LIM 'TRC1', 'C:
\Users\Public\Documents
\Rohde-Schwarz\Vna\LIMitLines\Lim_Trcl.limit'
```

Store the limit line definition of Trc1 to a limit line file.

```
MMEM:LOAD:LIM 'TRC2', 'C:
\Users\Public\Documents
\Rohde-Schwarz\Vna\LIMitLines\Lim_Trcl.limit'
```

Load the previously created limit line file and assign the limit lines to Trc2.

```
MMEM:STOR:TRAC 'TRC1', 'C:
\Users\Public\Documents
\Rohde-Schwarz\Vna\LIMitLines\Trcl.slp'
```

Store the current trace data of Trc1 to a limit line file in Touchstone format.

```
MMEM:LOAD:LIM 'TRC1', 'C:
\Users\Public\Documents
\Rohde-Schwarz\Vna\LIMitLines\Trcl.slp', 'S11',
0, 2, LMAX
```

Load the previously created Touchstone limit line file and assign the limit lines to Trc1, applying a response offset of 2 dB.

```
CALC:LIMit:DISPlay ON
```

Show the limit line in the diagram.

**Usage:** Setting only

**Manual operation:** See "[Recall / Save Limit Line...](#)" on page 200

---

#### **MMEMory:LOAD:RIPPLE** <TraceName>, <RippleLimFile>

Loads a ripple limit definition from a specified file and assigns it to a trace with a specified name. Ripple limits are created using the `CALCulate<Ch>:RIPPLE...` commands.

#### **Setting parameters:**

<TraceName> Name of an existing trace in the active setup (string parameter). The imported ripple limit line is assigned to this trace, irrespective of the trace information in the ripple limit file.

\*RST: -

<RippleLimFile> String parameter to specify the name and directory of the ripple limit file to be loaded. The default extension (manual control) for ripple limit files is \*.ripple, although other extensions are allowed. If no path is specified the analyzer searches the current directory, to be queried with `MMEMory:CDIRectory?`.

- Example:** Assume that the current setup contains two traces named Trc1 and Trc2, respectively, and that ripple limits have been defined for Trc1.
- ```
MMEM:STOR:RIPP 'TRC1', 'C:\Users\Public\Documents\Rohde-Schwarz\Vna\LIMitLines\Lim_Trcl.limit'
```
- Store the ripple limit definition of Trc1 to a ripple limit file.
- ```
MMEM:LOAD:RIPP 'TRC2', 'C:\Users\Public\Documents\Rohde-Schwarz\Vna\LIMitLines\Lim_Trcl.limit'
```
- Load the previously created ripple limit file and assign the limits to Trc2.
- ```
CALC:RIPP:DISPlay ON
```
- Show the ripple limit line for the active trace in the diagram.
- Usage:** Setting only
- Manual operation:** See "[Recall / Save Ripple Test...](#)" on page 205

---

#### **MMEMory:LOAD:SEGMent** <Channel>, <SweepSegFile>

Loads a sweep segment definition from a specified file and assigns it to a specified channel. Sweep segments are defined using the [SENSe<Ch>:] SEGment<Seg>... commands.

#### **Setting parameters:**

- <Channel> Channel number.
- <SweepSegFile> String parameter to specify the name and directory of the sweep segment file to be loaded. The default extension (manual control) for sweep segment files is \*.seglist, although other extensions are allowed. If no path is specified the analyzer searches the current directory, to be queried with [MMEMory:CDIRectory](#) ?.

- Example:** Assume that the current recall set contains two channels numbered 1 and 2, respectively, and that sweep segments have been defined for channel no. 1.
- ```
MMEM:STOR:SEGM 1, 'C:\Users\Public\Documents\Rohde-Schwarz\Vna\SweepSegments\Seg_Ch1.seglist'
```
- Store the sweep segment definition of channel 1 to a sweep segment file.
- ```
MMEM:LOAD:SEGM 2, 'C:\Users\Public\Documents\Rohde-Schwarz\Vna\SweepSegments\Seg_Ch1.seglist'
```
- Load the previously created sweep segment file and use the sweep segments for channel 2.
- Usage:** Setting only
- Manual operation:** See "[Import... / Export...](#)" on page 246

**MMEMory:LOAD:STATe** <Compatibility>, <RecallSetFile>

Loads configuration data from a specified recall set file and sets the analyzer to the corresponding instrument state.

**Setting parameters:**

|                 |                                                                                                                                                                                                                                                                                                                                    |
|-----------------|------------------------------------------------------------------------------------------------------------------------------------------------------------------------------------------------------------------------------------------------------------------------------------------------------------------------------------|
| <Compatibility> | 1 (this value is used for compatibility with the SCPI standard but is ignored).                                                                                                                                                                                                                                                    |
| <RecallSetFile> | String parameter to specify the name and directory of the recall set file to be loaded. The default extension (manual control) for recall set files is *.znx, although other extensions are allowed. If no path is specified the analyzer searches the current directory, to be queried with <a href="#">MMEMory:CDIRectory?</a> . |

**Example:**

```
MMEM:STOR:STAT 1, 'C:\Users\Public\Documents\
Rohde-Schwarz\Vna\RecallSets\Set_0413.znx'
Store the current setup configuration in the file Set_0413.znx
in the default directory for recall set files.
MMEM:LOAD:STAT 1, 'C:\Users\Public\Documents\
Rohde-Schwarz\Vna\RecallSets\Set_0413.znx'
Load the settings stored in Set_0413.znx.
```

**Usage:** Setting only

**Manual operation:** See "[Open Recall](#)" on page 122

**MMEMory:LOAD:TRACe** <DestinationTraceName>, <TraceFile>[, <SParamOrTraceName>]

Loads trace data from a specified trace file and assigns it to a trace with a specified name. Traces are created using the [CALCulate<Ch>:PARAMeter:SDEFine](#) command.

**Setting parameters:**

|                        |                                                                                                                                                                                                                                                                                                                                                                           |
|------------------------|---------------------------------------------------------------------------------------------------------------------------------------------------------------------------------------------------------------------------------------------------------------------------------------------------------------------------------------------------------------------------|
| <DestinationTraceName> | Name of an existing data trace in the active recall set (string parameter). The trace data is loaded into a memory trace associated with the specified data trace. If one or more memory traces are already associated with the specified data trace, the last generated memory trace is overwritten.                                                                     |
| <TraceFile>            | String parameter to specify the name and directory of the trace file to be loaded. Several file formats for trace files are supported. If no path is specified the analyzer searches the current directory, to be queried with <a href="#">MMEMory:CDIRectory?</a> . The file extensions *.s<n>p, *.csv, and *.dat for Touchstone, ASCII, and Matlab files are mandatory. |

<SParamOrTraceName> Optional string parameter: For imported Touchstone files for more than one port (\*.s2p, \*.s3p, \*.s4p), the parameter denotes the imported S-parameter ('S11', 'S12', ...). For ASCII (\*.csv) and Matlab (\*.dat) files, the parameter references a trace name in the file (case sensitive). If the parameter is omitted, the first trace in the specified file is imported.

**Example:**

Assume that the current recall set contains a trace named Trc1.  
 MMEM:STOR:TRAC 'TRC1', 'C:\Users\Public  
 \Documents\Rohde-Schwarz\Vna\Traces\Trc1.s1p'

Store the current trace data of Trc1 to a trace file.

MMEM:LOAD:TRAC 'TRC1', 'C:\Users\Public  
 \Documents\Rohde-Schwarz\Vna\Traces\Trc1.s1p'

Load the previously created trace file and create a memory trace assigned to Trc1.

CALC:PAR:DEF:SGR 1,2

Create four traces to measure the two-port S-parameters  $S_{11}$ ,  $S_{12}$ ,  $S_{21}$ ,  $S_{22}$ . The traces are not displayed.

MMEM:STOR:TRAC 'TRC1', 'C:\Users\Public  
 \Documents\Rohde-Schwarz\Vna\Traces\Trc1.s2p'

Store the four S-parameter traces to a two-port Touchstone file.

MMEM:LOAD:TRAC 'TRC1', 'C:\Users\Public  
 \Documents\Rohde-Schwarz\Vna\Traces\Trc1.s2p'

Load the previously created Touchstone file and overwrite the previously generated memory trace assigned to Trc1 with the  $S_{11}$  trace.

**Usage:** Setting only

**Manual operation:** See ["Import..."](#) on page 190

**MMEMory:LOAD:TRACe:AUTO <TraceFile>**

Loads the specified trace file and automatically distributes the imported S-parameter traces  $S_{ij}$  to all diagrams in the active channel that are currently displaying  $S_{ij}$ .

**Setting parameters:**

<TraceFile> String parameter to specify the name and directory of the trace file to be loaded. Several file formats for trace files are supported. If no path is specified the analyzer searches the current directory, to be queried with [MMEMory:CDIRectory?](#). The file extensions \*.s<n>p, \*.csv, and \*.dat for Touchstone, ASCII, and Matlab files are mandatory.

**Usage:** Setting only

**Manual operation:** See ["Auto Distribute"](#) on page 194

**MMEMory:MDIRectory <NewDirectory>**

Creates a new subdirectory for mass memory storage in an existing directory.

**Setting parameters:**

<NewDirectory> String parameter to specify the new directory. Either the full path or a subdirectory for the current directory (see [MMEMory:CDIRectory](#)).

**Example:**

```
MMEM:MDIR 'C:\Users\Public\New_Directory'
Create the specified directory. The parent directory
C:\Users\Public must have been created before.
MMEM:MDIR 'C:
\Users\Public\New_Directory\New_Subdirectory'
Create an additional subdirectory.
MMEM:CDIR 'C:\Users\Public\Instrument'; MDIR
'New_Directory'
Create an additional directory
C:\Users\Public\Instrument\New_Directory.
```

**Usage:** Setting only

**MMEMory:MOVE <SourceFile>, <NewFile>**

Moves a file to the indicated directory and stores it under the file name specified, if any. If <NewFile> contains no path indication, the command renames the file without moving it.

**Setting parameters:**

<SourceFile>

<NewFile> String parameters to specify the name and the path of the file to be copied and the name and the path of the new file.

**Example:**

```
MMEM:MOVE 'C:\Users\Public\Documents
\Rohde-Schwarz\Vna\RecallSets\SET1.znx', 'D:'
Move file Set1.znx in directory C:
\Users\Public\Documents
\Rohde-Schwarz\Vna\RecallSets to an external storage
medium, mapped to drive D: \.
```

**Usage:** Setting only

**MMEMory:NAME <Filename>**

Defines a name for a file which can be used to store the printer output. The file is created when it is selected as a printer destination ([HCOPY:DESTination](#)'MMEM').

**Parameters:**

<Filename> String parameter to specify the file name. The supported file formats are \*.wmf, \*.ewmf, \*.bmp, \*.png; see command [HCOPY:DEvice:LANGuage](#). The specified directory must exist, otherwise no file can be generated. If no path is specified the analyzer uses the current directory, to be queried with [MMEMory:CDIRectory?](#).

```
*RST: 'Hardcopy'
```

**Example:** `MMEM:NAME 'C:\Users\Public\Screenshots\PLOT1.BMP'`  
 Define a printer file name, to be stored in the existing directory `C:\Users\Public\Screenshots` (without creating the file).  
`HCOP:DEST 'MMEM'; :HCOP`  
 Select "Print to file" and create the printer file specified before.

#### **MMEMory:RDIRectory** <Directory>

Removes an existing directory from the mass memory storage system.

##### **Setting parameters:**

<Directory> String parameter to specify the directory.

**Example:** `MMEM:RDIR 'C:\Users\Public\NetworkService\Application Data'`  
 Removes the specified directory.

**Usage:** Setting only

#### **MMEMory:STORe:CKIT** <CalKitName>, <CalKitFile>

Stores the data of a calibration kit to a specified file. The calibration kit is identified by its name.

##### **Setting parameters:**

<CalKitName> Name of a user-defined calibration kit available on the analyzer.  
**Tip:** It is not possible to modify or store predefined or ideal kits.

<CalKitFile> String parameter to specify the name and directory of the cal kit file to be created. The file is a network analyzer-specific cal kit file with the extension \*.calkit. If no path is specified the analyzer uses the current directory, to be queried with [MMEMory:CDIRectory?](#).

**Example:** `MMEM:LOAD:CKIT 'C:\Users\Public\Documents\Rohde-Schwarz\Vna\Calibration\Kits\New Kit 1.calkit'`  
 Load the previously created cal kit file `New Kit 1.calkit` from the default cal kit directory.  
`... :MMEM:STOR:CKIT 'New Kit 1', 'C:\Users\Public\Documents\Rohde-Schwarz\Vna\Calibration\Kits\New Kit 1.calkit'`  
 Store the data for the user-defined cal kit "New Kit 1" and overwrite the cal kit file `New Kit 1.calkit`.

**Usage:** Setting only

**Manual operation:** See "[Import / Export](#)" on page 277

**MMEMory:STORe:CKIT:WLABel** <CalKitName>, <KitLabel>, <CalKitFile>

Stores the data of a calibration kit to a specified file. The calibration kit is identified by its name and label.

**Setting parameters:**

|              |                                                                                                                                                                                                                                                                                                |
|--------------|------------------------------------------------------------------------------------------------------------------------------------------------------------------------------------------------------------------------------------------------------------------------------------------------|
| <CalKitName> | Name of a user-defined calibration kit available on the analyzer.<br><b>Tip:</b> It is not possible to modify or store predefined or ideal kits.                                                                                                                                               |
| <KitLabel>   | Label of the calibration kit, usually its serial number.                                                                                                                                                                                                                                       |
| <CalKitFile> | String parameter to specify the name and directory of the cal kit file to be created. The file is a NWA-specific cal kit file with the extension *.calkit. If no path is specified the analyzer uses the current directory, to be queried with <a href="#">MMEMory:CDIRectory</a> on page 549. |

**Example:** See [\[SENSe:\]CORRection:CKIT:LLABel](#)

**Usage:** Setting only

**MMEMory:STORe:CMAP** <ColorSchemeFile>

Stores a color scheme to a specified VNA color scheme file.

**Setting parameters:**

|                   |                                                                                                                                                                                                                                                                                                                                             |
|-------------------|---------------------------------------------------------------------------------------------------------------------------------------------------------------------------------------------------------------------------------------------------------------------------------------------------------------------------------------------|
| <ColorSchemeFile> | String parameter to specify the name and directory of the color scheme file to be created. If no path is specified the analyzer uses the current directory, to be queried with <a href="#">MMEMory:CDIRectory?</a> . The default extension (manual control) for color scheme files is *.ColorScheme, although other extensions are allowed. |
|-------------------|---------------------------------------------------------------------------------------------------------------------------------------------------------------------------------------------------------------------------------------------------------------------------------------------------------------------------------------------|

**Example:** See [MMEMory:LOAD:CMAP](#)

**Usage:** Setting only

**Manual operation:** See "Recall / Save" on page 330

**MMEMory:STORe:CORRection** <Channel>, <CalGroupFile>

Copies the correction data of channel <Channel> to the cal pool, generating a new correction data file (cal group). The file has the extension \*.cal and is stored in the C:\Users\Public\Documents\Rohde-Schwarz\Vna\Calibration\Data directory.

**Setting parameters:**

|                |                                                                                                                                                                                                                                                                             |
|----------------|-----------------------------------------------------------------------------------------------------------------------------------------------------------------------------------------------------------------------------------------------------------------------------|
| <Channel>      | Channel number                                                                                                                                                                                                                                                              |
| <CalGroupFile> | String parameter to specify the name of the created cal group file. There is no need to specify the directory path and file extension; the analyzer uses the default cal pool directory C:\Users\Public\Documents\Rohde-Schwarz\Vna\Calibration\Data and a *.cal extension. |

- Example:** See [MMEMory:LOAD:CORRection](#)
- Usage:** Setting only
- Manual operation:** See "[Add / Add All / Replace / Apply / Apply to All](#)" on page 295

#### **MMEMory:STORe:CORRection:TCOefficient** <TraceFile>

Saves the current power loss list to a specified power meter correction list file.

##### **Setting parameters:**

- <TraceFile> String parameter to specify the name and directory of the created power meter correction list file. The file extension \*.pmc1 is mandatory. If no path is specified the analyzer searches the current directory, to be queried with [MMEMory:CDIRectory?](#).
- \*RST: n/a

**Example:** See [SOURce<Ch>:POWer<PhyPt>:CORRection:TCOefficient:CALibration](#)

- Usage:** Setting only
- Manual operation:** See "[Recall... / Save...](#)" on page 292

#### **MMEMory:STORe:LIMit** <TraceName>, <LimLineFile>

Saves the limit lines associated to a specified trace to a limit line file. Limit lines are created using the [CALCulate<Chn>:LIMit...](#) commands.

##### **Setting parameters:**

- <TraceName> Name of an existing trace in the active recall set (string parameter) for which a limit line definition exists.
- <LimLineFile> String parameter to specify the name and directory of the created limit line file. The default extension (manual control) for limit line files is \*.limit, although other extensions are allowed. If no path is specified the analyzer uses the current directory, to be queried with [MMEMory:CDIRectory?](#).

- Example:** See [MMEMory:LOAD:LIMit](#)
- Usage:** Setting only
- Manual operation:** See "[Recall / Save Limit Line...](#)" on page 200

#### **MMEMory:STORe:MARKer** <AsciiFile>

Saves the values of all markers to an ASCII file.



**Setting parameters:**

<AsciiFile> String parameter to specify the name and directory of the created ASCII file. The default extension (manual control) for marker files is \*.txt, although other extensions are allowed. If no path is specified the analyzer uses the current directory, to be queried with [MMEMemory:CDIRectory?](#). An example for the file contents is given below.

**Example:**

```
*RST
Reset the analyzer, creating the default trace no. 1 in channel
no. 1.
CALC:MARK ON; MARK:X 1GHz
Create marker no. 1 and place it to 1 GHz.
CALC:MARK2 ON; MARK2:X 2GHz
Create a second marker and place it to 2 GHz.
MME:STOR:MARK 'Marker.txt'
Store the marker values to an ASCII file. The file contains both
marker values, e.g.:
Trc1 S21
Mkr 1 1.000000 GHz -4.900 dB
Mkr 2 2.000000 GHz -6.807 dB
```

**Usage:** Setting only

**Manual operation:** See ["Export Markers"](#) on page 214

**MMEMemory:STORe:RIPPlE** <TraceName>, <RippleLimFile>

Saves the ripple limits associated with a specified trace to a ripple limit file. Ripple limit definitions are created using the `CALCulate<Chn>:RIPPlE...` commands.

**Setting parameters:**

<TraceName> Name of an existing trace in the active setup (string parameter) for which a ripple limit definition exists.

<RippleLimFile> String parameter to specify the name and directory of the created ripple limit file. The default extension (manual control) for ripple limit files is \*.ripple, although other extensions are allowed. If no path is specified the analyzer uses the current directory, to be queried with [MMEMemory:CDIRectory?](#)

**Example:** See [MMEMemory:LOAD:LIMit](#)

**Usage:** Setting only

**Manual operation:** See ["Recall / Save Ripple Test..."](#) on page 205

**MMEMemory:STORe:SEGMeNt** <Channel>, <SweepSegFile>

Saves the sweep segment definition of a specified channel to a sweep segment file. Sweep segments are defined using the `[SENSe<Ch>:]SEGMeNt<Seg>...` commands.

**Setting parameters:**

|                |                                                                                                                                                                                                                                                                                                                                       |
|----------------|---------------------------------------------------------------------------------------------------------------------------------------------------------------------------------------------------------------------------------------------------------------------------------------------------------------------------------------|
| <Channel>      | Channel number                                                                                                                                                                                                                                                                                                                        |
| <SweepSegFile> | String parameter to specify the name and directory of the created sweep segment file. The default extension (manual control) for sweep segment files is *.seglist, although other extensions are allowed. If no path is specified the analyzer uses the current directory, to be queried with <a href="#">MMEMemory:CDIRectory?</a> . |

**Example:** See [MMEMemory:LOAD:SEGMENT](#)

**Usage:** Setting only

**Manual operation:** See "[Import... / Export...](#)" on page 246

**MMEMemory:STORE:STATe** <Compatibility>, <RecallSetFile>

Stores the configuration data of the current recall set to a specified recall set file.

[MMEMemory:STORE:STATe](#) renames the current recall set, appending a .znx extension. See example for [MMEMemory:LOAD:STATe](#).

**Setting parameters:**

|                 |                                                                                                                                                                                                                                                                                                                             |
|-----------------|-----------------------------------------------------------------------------------------------------------------------------------------------------------------------------------------------------------------------------------------------------------------------------------------------------------------------------|
| <Compatibility> | 1 (this value is used for compatibility with the SCPI standard but ignored).                                                                                                                                                                                                                                                |
| <RecallSetFile> | String parameter to specify the name and directory of the created recall set file. The default extension (manual control) for recall set files is *.znx, although other extensions are allowed. If no path is specified the analyzer uses the current directory, to be queried with <a href="#">MMEMemory:CDIRectory?</a> . |

**Example:** See [MMEMemory:LOAD:STATe](#)

**Usage:** Setting only

**Manual operation:** See "[Save](#)" on page 122

**MMEMemory:STORE:TRACe** <TraceName>, <TraceFile>[, <FormatInd>, <Format>, <DecSeparator>, <FieldSeparator>]

Stores the trace data of a specified data trace to a trace file. Traces are created using the [CALCulate<Ch>:PARAMeter:SDEFine](#) command.

**Tip:** \* .s<n>p Touchstone files (<n> = 1, 2, 3, ...) are intended for a complete set of <n>-port S-parameters. Data export fails if the active channel does not contain the full set of <n><sup>2</sup> traces or if the involved ports are not numbered consecutively, starting with port 1. If the necessary traces are available, '<trc\_name>' can be the name of any of the traces. To create Touchstone files while less than <n><sup>2</sup> single-ended traces are available, use [MMEMemory:STORE:TRACe:PORTs](#).

**Setting parameters:**

|             |                                                                             |
|-------------|-----------------------------------------------------------------------------|
| <TraceName> | Name of an existing data trace in the active recall set (string parameter). |
|-------------|-----------------------------------------------------------------------------|

|                  |                                                                                                                                                                                                                                                                                                                                                                                                                                                                                                                       |
|------------------|-----------------------------------------------------------------------------------------------------------------------------------------------------------------------------------------------------------------------------------------------------------------------------------------------------------------------------------------------------------------------------------------------------------------------------------------------------------------------------------------------------------------------|
| <TraceFile>      | String parameter to specify the name and directory of the created trace file. Several file formats for trace files are supported. The file extensions *.s<n>p, *.csv, and *.dat for Touchstone, ASCII, and Matlab files are mandatory. To generate a multiport Touchstone file *.s2p, *.s3p..., the channel must contain traces for the full set of S-parameters; the '<trc_name>' is ignored. If no path is specified the analyzer uses the current directory, to be queried with <code>MMEMory:CDIRectory?</code> . |
| <FormatInd>      | FORMatted   UNFormatted<br>UNFormatted - unformatted data export specified by the second optional parameter.<br>FORMatted - formatted data export (for *.csv and *.dat files only).<br>If the first optional parameter is omitted, the command stores unformatted data.                                                                                                                                                                                                                                               |
| <Format>         | COMPLex   LINPhase   LOGPhase<br>COMPLex - complex values (real and imaginary part)<br>LINPhase - linear magnitude and phase.<br>LOGPhase - dB-magnitude and phase.<br>If the second optional parameter is omitted, the command stores complex data.                                                                                                                                                                                                                                                                  |
| <DecSeparator>   | POINT   COMMa<br>POINT - decimal separator: point.<br>COMMa - decimal separator: comma.<br>If the third optional parameter is omitted, points are used.                                                                                                                                                                                                                                                                                                                                                               |
| <FieldSeparator> | SEMicolon   COMMa   TABulator   SPACe<br>SEMicolon - field separator: semicolon<br>COMMa - field separator: comma.<br>TABulator - field separator: tabulator.<br>SPACe - field separator: space.<br>If the fourth optional parameter is omitted, semicolons are used.                                                                                                                                                                                                                                                 |

**Example:** See `MMEMory:LOAD:TRACe`

**Usage:** Setting only

**Manual operation:** See "Export..." on page 190

---

**MMEMory:STORe:TRACe:CHANnel** <Channel>, <TraceFile>[, <FormatInd>, <Format>, <DecSeparator>, <FieldSeparator>]

Stores the trace data of all data traces in the specified channel to a trace file. Traces are created using the `CALCulate<Ch>:PARAMeter:SDEFine` command.

**Tip:** \*.s<n>p Touchstone files (<n> = 1, 2, 3, ...) are intended for a complete set of <n>-port S-parameters. Data export fails if the active channel does not contain the full set of <n><sup>2</sup> traces.

**Setting parameters:**

|                  |                                                                                                                                                                                                                                                                                                                                                                                                                                                                                |
|------------------|--------------------------------------------------------------------------------------------------------------------------------------------------------------------------------------------------------------------------------------------------------------------------------------------------------------------------------------------------------------------------------------------------------------------------------------------------------------------------------|
| <Channel>        | Channel number in the active recall set. ALL means that a separate file is created for each channel in the active recall set.                                                                                                                                                                                                                                                                                                                                                  |
| <TraceFile>      | String parameter to specify the name and directory of the created trace file. Several file formats for trace files are supported. The file extensions *.s<n>p, *.csvc, and *.dat for Touchstone, ASCII, and Matlab files are mandatory. To generate a multiport Touchstone file *.s2p, *.s3p..., the channel must contain traces for the full set of S-parameters. If no path is specified the analyzer uses the C:\Users\Public\Documents\Rohde-Schwarz\Vna\Traces directory. |
| <FormatInd>      | FORMatted   UNFormatted<br>UNFormatted - unformatted data export specified by the second optional parameter.<br>FORMatted - formatted data export (for *.csv and *.dat files only).<br>If the first optional parameter is omitted, the command stores unformatted data.                                                                                                                                                                                                        |
| <Format>         | COMPLex   LINPhase   LOGPhase<br>COMPLex - complex values (real and imaginary part)<br>LINPhase - linear magnitude and phase.<br>LOGPhase - dB-magnitude and phase.<br>If the second optional parameter is omitted, the command stores complex data.                                                                                                                                                                                                                           |
| <DecSeparator>   | POINT   COMMa<br>POINT - Decimal separator: point.<br>COMMa - Decimal separator: comma.<br>If the third optional parameter is omitted, points are used.                                                                                                                                                                                                                                                                                                                        |
| <FieldSeparator> | SEMicolon   COMMa   TABulator   SPACe<br>SEMicolon - Field separator: semicolon<br>COMMa - field separator: comma.<br>TABulator - field separator: tabulator.<br>SPACe - field separator: space.<br>If the third optional parameter is omitted, semicolons are used.                                                                                                                                                                                                           |

**Example:**            `*RST; :CONF:TRAC:NAME?`  
 Reset the instrument, creating a default channel no 1 and a default trace Trc1.  
`CALC:PAR:DEF:SGR 1,2`  
 Create four traces to measure the two-port S-parameters  $S_{11}$ ,  $S_{12}$ ,  $S_{21}$ ,  $S_{22}$ . The traces are not displayed.  
`MMEM:STOR:TRAC:CHAN 1, 'C:\Users\Public\Documents\Rohde-Schwarz\Vna\Traces\Chn1.csv'`  
 Store all trace data of channel 1 to a trace file.  
`MMEM:STOR:TRAC:CHAN 1, 'C:\Users\Public\Documents\Rohde-Schwarz\Vna\Traces\Chn1.s2p'`  
 Store the four S-parameter traces to a two-port Touchstone file. The Touchstone file will not contain the default trace Trc1.

**Usage:**            Setting only

**Manual operation:** See ["Export..."](#) on page 190

---

#### **MMEMory:STORe:TRACe:OPTion:PLUS** <arg0>

This command defines how positive numbers are prefixed during Touchstone file export: by a leading space, a plus sign or not at all.

**Parameters:**

<arg0>            SPACE | PLUS | VOID

**Manual operation:** See ["Positive number prefix"](#) on page 340

---

#### **MMEMory:STORe:TRACe:OPTion:SSEPARATOR** <Boolean>

This command defines whitespace insertion during Touchstone file export.

If set to ON, separator lines are skipped, i.e. the content parts are no longer separated by blank lines.

**Parameters:**

<Boolean>

**Manual operation:** See ["Skip separator lines"](#) on page 340

---

#### **MMEMory:STORe:TRACe:OPTion:TABS** <Boolean>

This command defines whitespace insertion during Touchstone file export.

If set to ON, columns are separated by tabs rather than spaces.

**Parameters:**

<Boolean>

**Manual operation:** See ["Use TAB \(instead of blanks\)"](#) on page 340

**MMEMory:STORe:TRACe:OPTion:TRIM** <Boolean>

This command defines whitespace insertion during Touchstone file export.

If set to ON, whitespace at the beginning of each line is removed.

**Parameters:**

<Boolean>

**Manual operation:** See ["Trim leading whitespace"](#) on page 340

**MMEMory:STORe:TRACe:PORTs** <Channel>, <TouchstoneFile>, <Format>[, <ModelImpedance>, <Port>, <Port>...]

Generates a Touchstone file for the specified ports. The Touchstone file (.snp where *n* is the number of ports) contains a full set of *n* single-ended S-parameters for the selected ports. Traces are created using the [CALCulate<Ch>:PARAmeter:SDEFine](#) command.

The command fails unless the conditions for Touchstone file export are met; see ["Conditions for Touchstone file export"](#) on page 70.

**Setting parameters:**

|                  |                                                                                                                                                                                                                                                                                                             |
|------------------|-------------------------------------------------------------------------------------------------------------------------------------------------------------------------------------------------------------------------------------------------------------------------------------------------------------|
| <Channel>        | Channel number in the active recall set.                                                                                                                                                                                                                                                                    |
| <TouchstoneFile> | String parameter to specify the name and directory of the created Touchstone file. The file extension *.s<n>p for a n-port Touchstone file is mandatory. If no path is specified the analyzer uses the current directory, to be queried with <a href="#">MMEMory:CDIRectory?</a> .                          |
| <Format>         | COMPLex   LINPhase   LOGPhase<br>COMPLex - complex values (real and imaginary part).<br>LINPhase - Linear magnitude and phase.<br>LOGPhase - dB-magnitude and phase.                                                                                                                                        |
| <ModelImpedance> | CIMPedance   PIMPedance<br><b>CIMPedance:</b> normalize to the common target impedance (from options line); this is the default if the parameter is omitted<br><b>PIMPedance:</b> normalize to the individual port reference impedances<br>see <a href="#">"Renormalization of S-parameters"</a> on page 71 |
| <Port>           | First port number                                                                                                                                                                                                                                                                                           |
| <Port>           | Second port number. Further port numbers can be used as needed.                                                                                                                                                                                                                                             |

- Example:** Suppose that a full two-port calibration for ports 1 and 2 and channel 1 has been performed, and that a DUT with two balanced ports is connected. The analyzer measures an arbitrary mixed mode S-parameter.
- ```
MMEM:STOR:TRAC:PORT 1, 'Test_CIMP.s2p',
COMPLex, CIMPedance 1,2
```
- Calculate all single-ended S-parameters, renormalize them to the common target impedance and store them to a two-port Touchstone file.
- ```
MMEM:STOR:TRAC:PORT 1, 'Test_PIMP.s2p',
COMPLex, PIMPedance 1,2
```
- Calculate all single-ended S-parameters, renormalize them to the individual port reference impedances and store them to a two-port Touchstone file.
- Usage:** Setting only
- Manual operation:** See ["Export..."](#) on page 190

### 6.3.13 OUTPut Commands

The `OUTPut...` commands control the characteristics of the analyzer's output ports.

|                                                      |     |
|------------------------------------------------------|-----|
| <a href="#">OUTPut&lt;Ch&gt;[:STATe]</a> .....       | 575 |
| <a href="#">OUTPut:UPORt:ECBits</a> .....            | 575 |
| <a href="#">OUTPut&lt;Ch&gt;:UPORt[:VALue]</a> ..... | 576 |

---

#### **OUTPut<Ch>[:STATe] <Boolean>**

Turns the internal source power at all ports and the power of all external generators on or off.

**Suffix:**  
 <Ch> Channel number. This suffix is ignored; the setting is valid for all channels.

**Parameters:**  
 <Boolean> ON | OFF - switch the power on or off.  
 \*RST: ON

**Example:** `OUTP OFF`  
 Turn off the RF source power.

**Manual operation:** See ["RF Off All Channels"](#) on page 231

---

#### **OUTPut:UPORt:ECBits <Boolean>**

Defines the usage of pins 16 to 19 of the USER PORT connector.

**Parameters:**

<Boolean>            ON – channel bits 4 to 7  
                          OFF – drive port 1 to 4  
                          \*RST:        ON

**Example:**            See `OUTPut<Ch>:UPORt[:VALue]`

**Manual operation:** See "Pin 16 - 19" on page 339

**OUTPut<Ch>:UPORt[:VALue] <BinValue>**

Sets or queries a channel-dependent eight-bit binary value to control eight independent output signals at the USER PORT connector (lines 8, 9, 10, 11 and lines 16, 17, 18, 19). The output signals are 3.3 V TTL signals which can be used to differentiate between up to 255 independent analyzer states. `OUTPut<Ch>:UPORt[:VALue]` itself does not change the analyzer state.

**Channel bit definition and activation**

The channel bits have the following properties:

- After a \*RST of the analyzer all channel bits (including the value for the active, sweeping channel no. 1) are set to zero; no signal is applied to pins 8 to 11 and 16 to 19 of the USER PORT connector.
- The value defined with `OUTPut<Ch>:UPORt[:VALue]` is assigned to channel no. <Ch>.
- The signals at the USER PORT connector reflect the channel bits of the **measuring** channel, i.e. the channel for which the analyzer performs a sweep. This channel is not necessarily identical with the active channel.
- The signals are switched on as soon as a measurement (sweep) in a channel with non-zero channel bits is started. They are changed whenever a channel with different channel bits becomes the measuring channel.
- The signals at the USER PORT connector are maintained after the analyzer enters the hold state. This happens if all channels use single sweep mode and if all sweep sequences have been terminated.
- Pins 16 to 19 may be reserved for monitoring the drive ports 1 to 4 of the analyzer (`OUTPut<Ch>:UPORt:ECBits OFF`). This leaves up to 16 different monitored channel states.

**Tip:** You can use the active channel number as a parameter for

`OUTPut<Ch>:UPORt[:VALue]` and monitor the activity of up to 255 different channels at the USER PORT connector; see example below. You can also use the USER PORT output signals as channel-dependent (or drive port-dependent) trigger signals for external devices. Furthermore you can use `CONTRol:AUXiliary:C[:DATA]` to transfer the eight bit value in decimal representation.

**Suffix:**

<Ch>                    Channel number



**Parameters:**

<BinValue> Binary value. The values correspond to the following states of the USER PORT connector:

- #B00000000 - no signal at any of the eight pins 8, 9, 10, 11, 16, 17, 18, 19
- #B00000001 - output signal at pin 8
- #B00000010 - output signal at pin 9
- #B00000011 - output signal at pins 8 and 9
- ...
- #B11111111 - output signal at pins 8, 9, 10, 11, 16, 17, 18, 19

Range: #B00000000 to #B11111111 (for setting command), 0 to 255 (query)

\*RST: #B00000000 (0)

**Example:**

```
*RST; :OUTP1:UPOR #B00000001
```

Assign the channel bit value #B00000001 to the active channel no. 1. The analyzer performs a measurement in channel no. 1, therefore the output signal at pin 8 is switched on.

```
CONF:CHAN2:STAT ON; OUTP2:UPOR #B00000010
```

Create channel no. 2, causing it to become the active channel, and assign the channel bit value #B00000010. The analyzer performs no measurement in channel no. 2, therefore the output signal is not changed.

```
CALC2:PAR:SDEF 'Ch2Tr1', 'S11'
```

Create a trace named 'Ch2Tr1' and assign it to channel 2. While the analyzer measures in channel 2, the output signal changes from pin 8 to pin 9.

```
OUTP:UPOR:ECB OFF
```

Reserve pin 16 to 19 for monitoring the drive ports of the analyzer.

**Manual operation:** See "[Channel Bits \(Decimal\)](#)" on page 338

### 6.3.14 PROGram Commands

The `PROGram...` commands control external application programs that can be run on the analyzer.

|                                                     |     |
|-----------------------------------------------------|-----|
| <code>PROGram[:SElected]:NAME</code> .....          | 577 |
| <code>PROGram[:SElected]:EXECute</code> .....       | 578 |
| <code>PROGram[:SElected]:WAIT</code> .....          | 579 |
| <code>PROGram[:SElected]:RETVAl?</code> .....       | 579 |
| <code>PROGram[:SElected]:INIMessage</code> .....    | 579 |
| <code>PROGram[:SElected]:INIPParameter</code> ..... | 580 |

---

#### **PROGram[:SElected]:NAME** <Program>

Selects the application to be run on the analyzer. At present, only the general parameter `PROG` is available. This means that `PROGram[:SElected]:EXECute` can start any program.

**Tip:** Use this command in order to avoid problems should the default value change in future firmware versions.

**Parameters:**

<Program>            PROG  
                          Any program running under Windows or any file that can be opened with an application program available on the analyzer.  
 \*RST:                PROG

**Example:**            See `PROGram[:SElected]:EXECute`

**PROGram[:SElected]:EXECute <AppName>**

Starts an application process or open a file using an application available on the analyzer.

Use the command sequence `PROGram[:SElected]:WAIT? ; PROGram[:SElected]:RETVAl?` to query the return value (see example below).

**Note:** It is not possible to run several programs simultaneously. If the command `PROGram[:SElected]:EXECute . . .` is sent while a previously started program is still executed, the analyzer generates a SCPI error -100, "Command error...".

**Tip: Executing batch files; command prompt**

When executing batch scripts or other DOS applications, the analyzer does not display any DOS windows; the screen is left for the vector network analyzer (VNA) application. The same applies to the Windows NT command prompt (`cmd.exe`). To access the command prompt, proceed as follows:

- Create a batch file (e.g. `Start_cmd.bat`) containing the command line `start cmd.exe` and store the file to `C:\Winnt\system32`.
- Execute the batch file: `PROG:EXEC 'C:\winnt\system32\Start_cmd.bat'`

The command prompt window is displayed in front of the VNA application. You can also open several command prompt windows simultaneously.

**Setting parameters:**

<AppName>            String variable containing the name and path of an application program to be executed or of a file to be opened. The path can be defined as an absolute path (e.g. 'c:\...') or relative to the current directory (`MMEMory:CDIRectory`). Blanks in the <AppName> can be used to separate the application name from (optional) parameters.

**Example:**            `PROG:SELected:NAME PROG`  
                           Select general program execution.  
                           `PROG:SELected:EXECute 'Exit42.bat'`  
                           Run batch script `Exit42.bat`.  
                           `PROG:SELected:WAIT?`  
                           Lock command execution and manual control of the analyzer  
                           until the batch job has finished. This is required for  
                           `PROG:SELected:RETVal?`  
                           Get the return value. The answer is ... 42.

**Usage:**             Setting only

### **PROG:SELected]:WAIT**

Locks command execution from the current controller program while a program started via `PROG[:SELected]:EXECute` is running. The analyzer does not execute any further commands or queries until the program is stopped or paused.

Use `PROG[:SELected]:WAIT?` before trying to retrieve the return value of the executed program (`PROG[:SELected]:RETVal?`).

**Example:**            See `PROG[:SELected]:EXECute`

### **PROG:SELected]:RETVal?**

Queries the return value of an application or process started via `PROG[:SELected]:EXECute`.

This will only be successful if preceded by a `PROG[:SELected]:WAIT?` query (see `PROG[:SELected]:WAIT` on page 579).

**Example:**            See `PROG[:SELected]:EXECute`

**Usage:**             Query only

### **PROG:SELected]:INIMessage <IniFile>[, <SendValue>]**

Writes a message `<SendValue>` into the preferences (`*.ini`) file specified by `<IniFile>`. The message is entered into the `[MESSAGE]` section using the fixed key `Send`; the value for the fixed key `Receive` is set to an empty string.

The query reads the value associated with the fixed key `Receive` from the `[MESSAGE]` section of the preferences file specified by `<IniFile>`. If no value exists for that key, the query returns an empty string.

Both commands can be used to establish a simple file-based two-way communication mechanism to an external application launched by `PROG[:SELected]:EXECute`; see example.

**Parameters:**

|             |                                                                                                                                                                                                              |
|-------------|--------------------------------------------------------------------------------------------------------------------------------------------------------------------------------------------------------------|
| <IniFile>   | Name and path of the *.ini file. The *.ini extension may be omitted as it is created automatically by the command. The specified path/directory must exist. If the *.ini file does not exist, it is created. |
| <SendValue> | Value for the fixed key <code>Send</code> .                                                                                                                                                                  |

**Example:**

```
PROG:INIM 'c:\preferences\myapp', 'this is a message'
```

Write the string `this is a message` into the file `c:\preferences\myapp.ini`. The contents of the file look like:

```
[MESSAGE] Send="this is a message" Receive=
```

Suppose the external program writes the string `this is a response` to the `Receive` key (and possibly deletes the contents of the `Send` key).

```
PROG:INIM? 'c:\preferences\myapp'
```

Query the value of the key `Receive` in the \*.ini file. The response is `"this is a response"`.

**PROGRAM[:SElected]:INIPParameter <IniFile>{ , <Key>,<Value> | '<Value>'}**

Defines and writes one or several key/value pairs into the preferences file (\*.ini) specified by <file\_path>. The information is entered into the [PARAMETER] section.

This command can be used to supply information to an external application launched by :PROGRAM[:SElected]:EXECute.

The query must be sent with a single <Key> value. It reads the value associated with the key from the [PARAMETER] section of the preferences file specified by <file\_path>. If the key/value pair does not exist, the query returns an empty string.

**Parameters:**

|           |                                                                                                                                                                                                              |
|-----------|--------------------------------------------------------------------------------------------------------------------------------------------------------------------------------------------------------------|
| <IniFile> | Name and path of the *.ini file. The *.ini extension may be omitted as it is created automatically by the command. The specified path/directory must exist. If the *.ini file does not exist, it is created. |
| <Key>     | Key for the key/value pair(s).                                                                                                                                                                               |
| <Value>   | String or numeric value for the key/value pair(s). If a string parameter is supplied, it has to be enclosed in single or double quotes.                                                                      |

**Example:** `PROG:INIP 'c:\preferences\myapp',  
'myparameter', 'myvalue', 'startf', 123.05`  
Write two key/value pairs into the file  
`c:\preferences\myapp.ini`. The contents of the file look  
like:  
`[PARAMETER]  
myparameter="myvalue"  
startf="123.05"`  
`PROG:INIP? 'c:\preferences\myapp',  
'myparameter'`  
Query the value of the key `myparameter` in the `*.ini` file. The  
response is `"myvalue"`.

### 6.3.15 [SENSe:] Commands

The `[SENSe:]...` commands affect the receiver settings of the R&S ZNC/ZND.

#### 6.3.15.1 [SENSe:]AVERage...

The `[SENSe:]AVERage...` commands set sweep averaging parameters. The sweep average is a noise-reduction technique which consists of calculating each measurement point as an average of the same measurement point over several consecutive sweeps.



In contrast to the sweep count (for single sweep mode, `[SENSe<Ch>:]SWEep:COUNT`), averaging is always channel-specific. Both features are completely independent from each other.

|                                                      |     |
|------------------------------------------------------|-----|
| <code>[SENSe&lt;Ch&gt;:]AVERage:CLEar</code> .....   | 581 |
| <code>[SENSe&lt;Ch&gt;:]AVERage:COUNT</code> .....   | 582 |
| <code>[SENSe&lt;Ch&gt;:]AVERage:MODE</code> .....    | 582 |
| <code>[SENSe&lt;Ch&gt;:]AVERage[:STATe]</code> ..... | 582 |

#### [SENSe<Ch>:]AVERage:CLEar

Starts a new average cycle, clearing all previous results and thus eliminating their effect on the new cycle.

**Suffix:**

`<Ch>` Channel number

**Example:**

`SENS1:AVER:COUN 15; :AVER ON`

Set the average factor for channel 1 to 15 (the mnemonic `SENS1` can be omitted) and enable the sweep average.

`AVER:COUN 5; CLE`

Reduce the average factor and restart the average.

**Usage:**

Event

**Manual operation:** See "[Factor / On / Reset](#)" on page 235

---

**[SENSe<Ch>:]AVERage:COUNT** <AverageFactor>

Defines the number of consecutive sweeps to be combined for the sweep average ("Factor").

**Suffix:**

<Ch> Channel number

**Parameters:**

<AverageFactor> Sweep average factor  
 Range: 1 to 1000  
 \*RST: 10

**Example:** See [[SENSe<Ch>:\]AVERage:CLEar](#)

**Manual operation:** See "[Factor / On / Reset](#)" on page 235

---

**[SENSe<Ch>:]AVERage:MODE** <Mode>

**Suffix:**

<Ch>

**Parameters:**

<Mode> AUTO | FLATten | REDuce | MOVing

**AUTO**

Automatic selection between REDuce and FLATten mode, depending on the trace format.

**FLATten**

Cumulative moving averages of the (linear) magnitude and phase values, provides the most effective noise suppression for the "dB Mag", "Phase", "Unwr. Phase", and "Lin Mag" formats.

**REDuce**

Cumulative moving averages of the real and imaginary parts of each measurement result, provides the most effective noise suppression for the "Real" and "Imag" formats and for polar diagrams.

**MOVing**

Simple moving averages of the real and imaginary parts of each measurement result; similar to **Reduce Noise**, but with finite history.

**Manual operation:** See "[Mode](#)" on page 236

---

**[SENSe<Ch>:]AVERage[:STATE]** <Boolean>

Enable or disable the sweep average.

**Suffix:**

<Ch> Channel number

**Parameters:**

<Boolean> ON | OFF - enables or disables the automatic calculation of the sweep average over the specified number of sweeps  
 ([SENSe<Ch>:]AVERage:COUNT).  
 \*RST: ON

**Example:** See [SENSe<Ch>:]AVERage:CLEar

**Manual operation:** See "Factor / On / Reset" on page 235

**6.3.15.2 [SENSe:]BANDwidth...**

The [SENSe:]BANDwidth... commands set the bandwidth of the IF measurement filter (resolution bandwidth). The forms BANDwidth and BWIDth are equivalent.

[SENSe<Ch>:]BANDwidth[:RESolution].....583  
 [SENSe<Ch>:]BWIDth[:RESolution].....583

**[SENSe<Ch>:]BANDwidth[:RESolution] <ResBandw>**

**[SENSe<Ch>:]BWIDth[:RESolution] <ResBandw>**

Defines the resolution bandwidth of the analyzer (Meas. Bandwidth). Values between 1 Hz and 100 kHz can be set.

Bandwidths can be set in 1 – 1.5 – 2 – 3 – 5 – 7 steps. The analyzer rounds up any entered value between these steps and rounds down values exceeding the maximum bandwidth.

**Suffix:**

<Ch> Channel number

**Parameters:**

<ResBandw> Resolution bandwidth  
 Range: See above  
 Increment: 1-1.5-2-3-5-7 steps  
 \*RST: 10 kHz  
 Default unit: Hz

**Example:**

BAND 1.1  
 Set a resolution bandwidth of approx. 1.1 Hz for channel 1.  
 BAND?  
 The analyzer returns the rounded bandwidth of 1.5 Hz.

**Manual operation:** See "Bandwidth" on page 234

**6.3.15.3 [SENSe:]CORRection:CDATa...**

The [SENSe:]CORRection:CDATa... commands read or write system error correction data.

**[SENSe<Ch>:]CORRection:CDATA** <ErrorTerm>, <SourcePort>, <LoadPort>, <CorrectionData>...

Writes or reads system error correction data for a specific channel <Ch>, calibration method (`[SENSe<Ch>:]CORRection:COLLect:METhod:DEFine`), and port combination <SourcePort>, <LoadPort>. The setting command can be used to transfer user-defined correction data <CorrectionData> to the analyzer; the query returns the current correction data set. ASCII or block data can be transferred, depending on the selected data transfer format (`FORMat[:DATA]`).

The sweep must be stopped to transfer calibration data; see program example for `[SENSe<Ch>:]CORRection:COLLect:SAVE:SElected:DEFault`.

**Note:** This command affects the active calibration of channel no. <Ch> or the factory calibration (if no channel calibration is active). For the factory calibration, the query form is allowed only (no change of factory calibration data).

**Tip:** The analyzer provides a default calibration corresponding to a test setup which does not introduce any systematic errors; see `[SENSe<Ch>:]CORRection:COLLect:SAVE:SElected:DEFault`.

For an overview of calibration methods and error terms refer to [Chapter 3.5.1, "Calibration Types"](#), on page 74.

### G and H matrices

The 7-term calibration types named Txx (e.g. TOM, TRM, TRL, TNA) are based on a network analyzer with two ports i and j, each equipped with a test receiver and a reference receiver. The system errors are described in terms of two "error two-ports"  $P_G$  and  $P_H$ :

- The error two-port  $P_G$  is assigned to port i of the analyzer. Its transmission matrix G describes how the system errors modify the outgoing and incident waves at port i:

$$\begin{bmatrix} \mathbf{b}_i \\ \mathbf{a}_i \end{bmatrix} = \begin{bmatrix} \mathbf{G}_{11} & \mathbf{G}_{12} \\ \mathbf{G}_{21} & \mathbf{G}_{22} \end{bmatrix} * \begin{bmatrix} \mathbf{m}_{i\text{ref}} \\ \mathbf{m}_{i\text{test}} \end{bmatrix}$$

- The error two-port  $P_H$  is assigned to port j of the analyzer. Its transmission matrix H describes how the system errors modify the measured incident and outgoing waves at port j:

$$\begin{bmatrix} \mathbf{a}_j \\ \mathbf{b}_j \end{bmatrix} = \begin{bmatrix} \mathbf{H}_{11} & \mathbf{H}_{12} \\ \mathbf{H}_{21} & \mathbf{H}_{22} \end{bmatrix} * \begin{bmatrix} \mathbf{m}_{j\text{test}} \\ \mathbf{m}_{j\text{ref}} \end{bmatrix}$$

In the two equations above, a and b denote the waves at the calibrated reference plane i and j (e.g. the input and output of the 2-port DUT). The m waves are the raw measured waves of test port i and j. The subscripts "ref" and "test" refer to the reference and test receivers, respectively. During the calibration the network analyzer acquires ratios of wave quantities, which leaves one of non-diagonal matrix elements of G or H as a free normalization factor. The network analyzer uses the normalization  $H_{21} = 1$ .

#### Suffix:

<Ch> Channel number of the calibrated channel.



**Parameters:**

|                  |                                                                                                                                                                                                                                                                                                                                                                                                                                                                                                                                                                                                                                                                                                                                                                                                                                                                                                                                                                                                                                                                                                                                                                                                                               |
|------------------|-------------------------------------------------------------------------------------------------------------------------------------------------------------------------------------------------------------------------------------------------------------------------------------------------------------------------------------------------------------------------------------------------------------------------------------------------------------------------------------------------------------------------------------------------------------------------------------------------------------------------------------------------------------------------------------------------------------------------------------------------------------------------------------------------------------------------------------------------------------------------------------------------------------------------------------------------------------------------------------------------------------------------------------------------------------------------------------------------------------------------------------------------------------------------------------------------------------------------------|
| <ErrorTerm>      | String parameters describing the different error terms, depending on the current calibration method; see table below. Each term contains one complex value (real and imaginary part) for each sweep point. The parameters must be transferred in full length. The following strings are allowed:<br>'DIRECTIVITY' – directivity at the <SourcePort><br>'SRCMATCH' – source match at the <SourcePort><br>'REFLTRACK' – reflection tracking at the <SourcePort><br>'LOADMATCH' – load match at the <LoadPort><br>'TRANSTRACK' – transmission tracking between the <SourcePort> and the <LoadPort>; see above.<br>'G11' ... 'G22' – G matrix elements, referenced to the <SourcePort> (irrespective of the values of <port1_no> and <port2_no>).<br>'H11' ... 'H22' – H matrix elements, referenced to the <LoadPort> (irrespective of the values of <SourcePort> and <LoadPort>); see above.<br>'Q11' ... 'Q22', 'PREL' – 9-term correction factors, for internal use (combine with <SourcePort> = 1, <LoadPort> is ignored).<br>'L1', 'L2', 'LA' – 9-term correction factors, for internal use only (combine with <SourcePort> = 1, <LoadPort> = 2).<br>Range: The error terms are dimensionless complex numbers.<br>*RST: n/a |
| <SourcePort>     | Source port number                                                                                                                                                                                                                                                                                                                                                                                                                                                                                                                                                                                                                                                                                                                                                                                                                                                                                                                                                                                                                                                                                                                                                                                                            |
| <LoadPort>       | Load port number. If the error term is not related to the load port, a dummy number can be used; e.g. <code>CORR:CDAT 'REFLTRACK', 1, 0</code>                                                                                                                                                                                                                                                                                                                                                                                                                                                                                                                                                                                                                                                                                                                                                                                                                                                                                                                                                                                                                                                                                |
| <CorrectionData> | Correction data set (one complex number per sweep point) to be transferred to the analyzer either in ASCII or block data format, depending on the current <code>FORMat[:DATA]</code> setting. The correction data set is assigned to the specified channel, error term, source and load port.<br>This parameter must not be used for queries.                                                                                                                                                                                                                                                                                                                                                                                                                                                                                                                                                                                                                                                                                                                                                                                                                                                                                 |

**Example:** See `[SENSe<Ch>:]CORRection:COLLect:SAVE:SELected:DEFault`.

The different calibration types of the analyzer provide the following error terms:

| Calibration type                                                      | Parameters in<br>[SENSe<Ch>:]CORRection:<br>COLLect:METhod:DEFine | Available error terms (depending on port numbers) |
|-----------------------------------------------------------------------|-------------------------------------------------------------------|---------------------------------------------------|
| One-port normalization (reflection) using an open or a short standard | REFL, RSHort                                                      | 'REFLTRACK'                                       |
| Full one port ("Refl OSM")                                            | FOPort                                                            | 'DIRECTIVITY', 'SRCMATCH', 'REFLTRACK'            |
| Two-port normalization                                                | FRTRans                                                           | 'TRANSTRACK'                                      |

|                         |                             |                                                                                                                                                                                                          |
|-------------------------|-----------------------------|----------------------------------------------------------------------------------------------------------------------------------------------------------------------------------------------------------|
| One path two port       | OPTPort                     | 'DIRECTIVITY', 'SRCMATCH', 'REFLTRACK', 'TRANSTRACK'                                                                                                                                                     |
| TOSM                    | TOSM                        | 'DIRECTIVITY', 'SRCMATCH', 'REFLTRACK', 'LOADMATCH', 'TRANSTRACK'                                                                                                                                        |
| TOM, TSM, TRM, TRL, TNA | TOM   TSM   TRM   TRL   TNA | 'DIRECTIVITY', 'SRCMATCH', 'REFLTRACK', 'LOADMATCH', 'TRANSTRACK' (for reading and writing)<br>'G11' ... 'G22' and 'H11', 'H12', 'H22' (for reading only; the 'H21' matrix elements are normalized to 1) |

#### 6.3.15.4 [SENSe:]CORRection:CKIT...

The [SENSe:]CORRection:CKIT... commands deal with calibration kits and cal kit data. The calibration kits are distinguished by their names (<CalkitName>), the optional labels (<label>) can be used to carry information about the calibration standard.

In order to handle several identical calibration kits with different serial numbers use the commands of chapter [Chapter 6.3.15.5, "\[SENSe:\]CORRection:CKIT... with Labels"](#), on page 595.

|                                                       |     |
|-------------------------------------------------------|-----|
| [SENSe:]CORRection:CKIT:<ConnType>:SElect.....        | 586 |
| [SENSe:]CORRection:CKIT:CATalog?.....                 | 587 |
| [SENSe:]CORRection:CKIT:DELeTe.....                   | 587 |
| [SENSe<Ch>:]CORRection:COLLect:CKIT:INSTall.....      | 588 |
| [SENSe:]CORRection:CKIT:LABel.....                    | 588 |
| [SENSe<Ch>:]CORRection:COLLect:CKIT:LOAD.....         | 588 |
| [SENSe<Ch>:]CORRection:COLLect:CKIT:PORT<PhyPt>?..... | 589 |
| [SENSe:]CORRection:CKIT:SElect.....                   | 589 |
| [SENSe:]CORRection:CKIT:STANdard:CATalog?.....        | 590 |
| [SENSe:]CORRection:CKIT:<StandardType>.....           | 590 |
| [SENSe:]CORRection:CKIT:DMODE.....                    | 594 |
| [SENSe:]CORRection:CKIT:STANdard:DATA?.....           | 594 |

#### [SENSe:]CORRection:CKIT:<ConnType>:SElect <CalKitName>

Selects the calibration kit to be used for a specified connector type <ConnType>. The kit is identified by its name.

**Tip:** For connector types with arbitrary, user-defined names you can use the command [SENSe:]CORRection:CKIT:SElect.

#### Cal kit naming conventions

Calibration kit names must be entered as string parameters. The string contains the cal kit name used in the calibration dialogs (e.g. "Calibration Presettings"); a "Ω" in the name must be replaced by Ohm, e.g.:

- NewKit1 denotes the user-defined calibration kit "NewKit1".
- N 50 Ohm Ideal Kit denotes the "N 50 Ω Ideal Kit".
- ZV-Z21 typical denotes the cal kit "ZV-Z21 typical".

**Suffix:**

<ConnType> Connector type, one of the following identifiers:  
 N50, N75 – N 50 Ω or N 75 Ω connectors  
 PC7, PC35, PC292 – PC 7, PC 3.5 or 2.92 mm connectors  
 USER<no> – user-defined connectors UserConn1, UserConn2  
 SMA – user-defined connector type SMA ...

**Parameters:**

<CalKitName> String parameter containing the name of a calibration kit available on the analyzer. See "Cal kit naming conventions " above.  
 \*RST: n/a (A \*RST does not change the assignment between connector types and calibration kits.)

**Example:**

```
MMEM:LOAD:CKIT 'C:\Users\Public
\Documents\Rohde-Schwarz
\Vna\Calibration\Kits\New Kit 1.calkit'
Load the previously created cal kit file New Kit 1.calkit
from the default cal kit directory.
CORR:CKIT:N50:SEL 'New Kit 1'
Assign the imported kit to the N 50 Ω connector type, assuming
that the cal kit name stored in New Kit 1.calkit reads New
Kit 1.
```

**Manual operation:** See ["Add / Copy / Delete / Standards..."](#) on page 276

**[SENSe:]CORRection:CKIT:CATalog? [<ConnectorType>]**

Returns a list of all cal kits for a given connector type or for all connector types.

**Query parameters:**

<ConnectorType> Name of the connector type (optional). Use [\[SENSe<Ch>:\]CORRection:CONNECTION:CATalog?](#) to query connector names.  
 If omitted, the command returns the list of all cal kits.

**Example:** See [\[SENSe<Ch>:\]CORRection:CONNECTION:CATalog?](#)

**Usage:** Query only

**Manual operation:** See ["Add / Copy / Delete / Standards..."](#) on page 276

**[SENSe:]CORRection:CKIT:DELeTe <CalKitName>**

Deletes an imported or user-defined cal kit.

**Note:** It is not possible to modify or store predefined or ideal kits.

**Setting parameters:**

<CalKitName> String parameter containing an imported or user-defined calibration kit available on the analyzer.

**Example:** See [\[SENSe:\]CORRection:CKIT:LABel](#)

**Usage:** Setting only

**Manual operation:** See "Add / Copy / Delete / Standards..." on page 276

---

**[SENSe<Ch>:]CORRection:COLLect:CKIT:INSTall** <CalKitFile>, <Gender>[, <Ports>, <Ports>...]

Allows to load cal kit data by gender

- from the given file
- to the given ports or all ports

Use **MMEMory:CKIT:INFO?** on page 550 to get information about cal kit files.

**Suffix:**

<Ch>

**Setting parameters:**

<CalKitFile> Path to the cal kit file, either absolute or relative to the current directory (see **MMEMory:CDIRectory**)

<Gender> MALE | FEMale | NGENder

<Ports>, <Ports>... Either a list of ports or ALL (optional)

**Usage:** Setting only

---

**[SENSe:]CORRection:CKIT:LABel** <CalKitName>[, <KitLabel>]

Assigns a label to an imported or user-defined calibration kit.

**Parameters:**

<CalKitName> String parameter containing an imported or user-defined calibration kit available on the analyzer.

<KitLabel> String parameter containing the calibration kit label.

**Example:**

```
CORR:CKIT:FOP 'N 50 Ohm', 'New Kit 1', '',
0,4000000000,0,0,50,99,-2.3,0.22,0,0,0,0,0
```

Create a new cal kit "New Kit 1" and assign an open (f) standard for the N 50 Ω connector type with specific properties.

```
CORR:CKIT:LAB 'New Kit 1', 'Test kit created
today'
```

Label the previously created kit.

```
CORR:CKIT:LAB? 'New Kit 1'
```

Check the label.

```
CORR:CKIT:DEL 'New Kit 1'
```

Delete the kit.

---

**[SENSe<Ch>:]CORRection:COLLect:CKIT:LOAD** <CalKitName>, <KitLabel>, <Gender>[, <Ports>, <Ports>...]

Allows to load cal kit data by name, label and gender

- from the pool
- to the given ports or all ports

**Suffix:**

<Ch> Channel number

**Setting parameters:**

<CalKitName> The name of the cal kit to be loaded

<KitLabel> The label of the cal kit to be loaded

<Gender> MALE | FEMale | NGENder  
The gender of the cal kit to be loaded

<Ports>, <Ports>... Either a list of ports or ALL (optional)

**Usage:** Setting only

**[SENSe<Ch>:]CORRection:COLLect:CKIT:PORT<PhyPt>? [<Detail>]**

Queries the cal kit data assigned to the given port via

- [SENSe<Ch>:]CORRection:COLLect:CKIT:LOAD  
or [SENSe<Ch>:]CORRection:COLLect:CKIT:INSTall

**Suffix:**

<Ch> Channel number

<PhyPt> Port number

**Query parameters:**

<Detail> CONNector | LABEL | NAME | GENDER  
Queried property

**Return values:**

<Result>

**Usage:** Query only

**[SENSe:]CORRection:CKIT:SElect <ConnectorType>[, <CalKitName>]**

Selects the calibration kit to be used, specifying its connector type and name (optional).

**Tip:** The command is suitable for connector types with arbitrary, user-defined names. For standard connector types you can use the command [SENSe:]CORRection:CKIT:<ConnType>:SElect.

**Parameters:**

<ConnectorType> Connector type, e.g. a user-defined connector type (string variable).

<CalKitName> String parameter containing the name of a calibration kit available on the analyzer.

**Example:**

```
MMEM:LOAD:CKIT 'C:\Users\Public
\Documents\Rohde-Schwarz
\Vna\Calibration\Kits\New Kit 1.calkit'
Load the previously created cal kit file New Kit 1.calkit
from the default cal kit directory.
CORR:CKIT:SEL 'N 50 Ohm', 'New Kit 1'
Assign the imported kit to the N 50 Ω connector type, assuming
that the cal kit name stored in New Kit 1.calkit reads New
Kit 1.
```

**Manual operation:** See ["Cal Kit"](#) on page 265

---

**[SENSe:]CORRection:CKIT:STANdard:CATalog? <CalKitName>**

Returns a list of all standards in a given calibration kit.

**Query parameters:**

<CalKitName> Name of the cal kit. Use [\[SENSe:\]CORRection:CKIT:CATalog?](#) to query cal kit names.

**Example:** See [\[SENSe<Ch>:\]CORRection:CONNection:CATalog?](#)

**Usage:** Query only

---

**[SENSe:]CORRection:CKIT:<StandardType> <ConnType>, <CalKitName>, <StandardLabel>, <MinFreq>, <MaxFreq>[, <DelayParam>, <Loss>, <Z0>[, <C0>, <C1>, <C2>, <C3>, <L0>, <L1>, <L2>, <L3>[, OPEN | SHORt | MATCh | <Resistance>[, <Port1>[, <Port2>]]]]]**

**[SENSe:]CORRection:CKIT:<StandardType>? <ConnType>, <CalKitName>[, <Port1>[, <Port2>]]]**

Defines the parameters of a (possibly non-ideal) 1 port or 2-port calibration standard <StandardType> within a particular cal kit. Depending on the standard type, only a subset of the parameters may be used; see [Table 6-5](#)

**Suffix:**

<StandardType> <string>  
Standard type  
For one-port standards the first character denotes the gender, for transmission standards the first two characters denote the genders on both ends, e.g. MOPen for a male Open standard or FFThrougH for a Through standard with female connectors. For a complete list of standards refer to [Table 6-7](#).

**Parameters:**

<StandardLabel> Additional string label for the standard, typically the standard's serial number

- CalStandardProps Parameters <MinFreq>, ..., OPEN | SHORt | MATCh | <Resistance> define the properties of the calibration standard. See [Parameter list](#).  
**Note:** Sliding Match and Attenuation standards have only 2 parameters (<MinFreq>,<MaxFreq>), Through and Line standards only have 5 parameters (<MinFreq>,...,<Z0>).
- <Port1>, <Port2> Optional port restriction.  
 For a one-port standard the validity of the standard characterization can be restricted to a single port, for a two-port standard it can be restricted to a port pair (specified using ascending port numbers).  
**Note:** with a port restriction the defined standard becomes sex-less. Hence, for each port (pair) there can be only one standard of a given type, i.e. :SENSe:CORRection:CKIT:MOP <ParameterList>,1 and :SENSe:CORRection:CKIT:FOP <ParameterList>,1 will overwrite each other.

**Parameters for setting and query:**

- <ConnType>, <CalkitName> String parameters uniquely identifying the cal kit to which the standard belongs.  
**Note:** If the specified cal kit does not exist, it is created with the specified calibration standard.

**Example:**

```
CORR:CKIT:FOP 'N 50 Ohm','New Kit 1', '',
0,4000000000,0,0,50,99,-2.3,0.22,0,0,0,0,0
Define the properties of the Open (f) standard for a N 50 Ω
connector type in cal kit "New Kit 1".
CORR:CKIT:FOP? 'N 50 Ohm'
Query the properties of the Open (f) standard for a N 50 Ω
connector type in the active cal kit.
CORR:CKIT:FOP? 'N 50 Ohm','New Kit 1'
Query the properties of the Open (f) standard for a N 50 Ω
connector type in cal kit "New Kit 1".
```

**Manual operation:** See "[Table Columns](#)" on page 278

**Table 6-5: Set command parameters**

|                      | One port standards                          |                |       |         |               | Two port standards |               |             |
|----------------------|---------------------------------------------|----------------|-------|---------|---------------|--------------------|---------------|-------------|
|                      | Open                                        | (Offset) Short | Match | Reflect | Sliding match | Symmetric Network  | Through, Line | Attenuation |
| <ConnType>           | mandatory                                   |                |       |         |               |                    |               |             |
| <CalKitName>         | mandatory (and must not be an empty string) |                |       |         |               |                    |               |             |
| <StandardLabel>      | mandatory (but may be an empty string)      |                |       |         |               |                    |               |             |
| <MinFreq>, <MaxFreq> | mandatory                                   |                |       |         |               |                    |               |             |

|                                                                                                                                                                                                                                                                                                                                                                                    |                    |             |             |                                            |          |                                            |          |          |
|------------------------------------------------------------------------------------------------------------------------------------------------------------------------------------------------------------------------------------------------------------------------------------------------------------------------------------------------------------------------------------|--------------------|-------------|-------------|--------------------------------------------|----------|--------------------------------------------|----------|----------|
| <Delay-Param>, <Loss>, <Z0>                                                                                                                                                                                                                                                                                                                                                        | mandatory          | mandatory   | mandatory   | mandatory                                  | not used | mandatory                                  |          | not used |
| <C0>, <C1>, <C2>, <C3>                                                                                                                                                                                                                                                                                                                                                             | mandatory          | mandatory*  | mandatory*  | mandatory**                                |          | mandatory**                                | not used |          |
| <L0>, <L1>, <L2>, <L3>                                                                                                                                                                                                                                                                                                                                                             | mandatory*         | mandatory   | mandatory*  | mandatory**                                |          | mandatory**                                |          |          |
| OPEN   SHORt   MATCh   <Resist-ance>                                                                                                                                                                                                                                                                                                                                               | optional***        | optional*** | optional*** | mandatory:<br>OPEN   SHORt   <Resist-ance> |          | mandatory:<br>OPEN   SHORt   <Resist-ance> |          |          |
| <Port1>[, <Port2>]                                                                                                                                                                                                                                                                                                                                                                 | optional: <Port 1> |             |             |                                            |          | optional: <Port 1>,<Port 2>                |          |          |
| <p>* values will be ignored during calibration</p> <p>** if OPEN is selected the residual inductance (L0,...,L3) will be ignored during calibration; if SHORt is selected the fringing capacitance (C0,...,C3) will be ignored during calibration</p> <p>*** must be provided if a port restriction &lt;Port 1&gt; shall be applied; values will be ignored during calibration</p> |                    |             |             |                                            |          |                                            |          |          |

The parameters in the [SENSe<Ch>:]CORRection:CKIT:<StandardType>, [SENSe<Ch>:]CORRection:CKIT:<StandardType>:WLABELs, and [SENSe<Ch>:]CORRection:CKIT:<ConnectorType>:<StandardType> commands have the following meaning:

Table 6-6: Parameter list

| Parameter            | Meaning                                                                                                                                                                                                                                                                                                                                                                                                  | Comment/Unit                                       |
|----------------------|----------------------------------------------------------------------------------------------------------------------------------------------------------------------------------------------------------------------------------------------------------------------------------------------------------------------------------------------------------------------------------------------------------|----------------------------------------------------|
| '<ConnType>'         | Name of the connector type.<br>Use <code>SENSe1:CORRection:CONNection:CATalog?</code> to query connector names.                                                                                                                                                                                                                                                                                          | String parameter                                   |
| '<CalKitName>'       | Name of the calibration kit. Use <code>[SENSe:]CORRection:CKIT:CATalog?</code> to query cal kit names.                                                                                                                                                                                                                                                                                                   | String parameter                                   |
| '<CalKitLabel>'      | Label (e.g. the serial number) of the calibration kit; for <code>...WLABEL</code> command only                                                                                                                                                                                                                                                                                                           | String parameter                                   |
| '<StandardLabel>'    | Label (e.g. the serial number) of the standard                                                                                                                                                                                                                                                                                                                                                           | String parameter                                   |
| <MinFreq>, <MaxFreq> | Min./max. frequency for which the circuit model is valid                                                                                                                                                                                                                                                                                                                                                 | Default unit is Hz                                 |
| <DelayParam>         | Depending on the cal kit's model type (selected using <code>[SENSe:]CORRection:CKIT:DMODE</code> ) this parameter is interpreted as <ul style="list-style-type: none"> <li>• delay [s] for Agilent modelling</li> <li>• el. length [m] for ZVR compatible modelling</li> </ul> Cal kits that are not created/modified using <code>[SENSe:]CORRection:CKIT:DMODE</code> use the ZVR compatible modelling. |                                                    |
| <Loss>               | Loss (offset parameter) of the standard                                                                                                                                                                                                                                                                                                                                                                  | To be specified without unit (implicit unit is dB) |

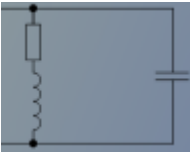

| Parameter                           | Meaning                                                                                                                                                                                                                                                                                                                                                                                                                                                                                                                                                                                                                                                                                                                                                                                 | Comment/Unit                                                                                                              |
|-------------------------------------|-----------------------------------------------------------------------------------------------------------------------------------------------------------------------------------------------------------------------------------------------------------------------------------------------------------------------------------------------------------------------------------------------------------------------------------------------------------------------------------------------------------------------------------------------------------------------------------------------------------------------------------------------------------------------------------------------------------------------------------------------------------------------------------------|---------------------------------------------------------------------------------------------------------------------------|
| <Z0>                                | Reference impedance (no unit)                                                                                                                                                                                                                                                                                                                                                                                                                                                                                                                                                                                                                                                                                                                                                           | To be specified without unit (implicit unit is Ω)                                                                         |
| <C0>, ..., <C3>                     | Polynomial coefficients for the fringing capacitance of the standard (load parameter)                                                                                                                                                                                                                                                                                                                                                                                                                                                                                                                                                                                                                                                                                                   | To be specified without unit: implicit unit of <C> is fF / (GHz) <sup>i</sup>                                             |
| <L0>, ..., <L3>                     | Polynomial coefficients for the residual inductance of the standard (load parameter)                                                                                                                                                                                                                                                                                                                                                                                                                                                                                                                                                                                                                                                                                                    | To be specified without unit: implicit unit of <L> is pH / (GHz) <sup>j</sup>                                             |
| OPEN   SHORT   MATCH   <Resistance> | <p>A load circuit model generally consists of a capacitance (modelled by &lt;C0&gt;, ..., &lt;C3&gt;) which is connected in parallel to an inductance (modelled by &lt;L0&gt;, ..., &lt;L3&gt;) and a resistance, both connected in series.</p> <p>OPEN   SHORT   MATCH indicates a simplified modelling as an Open or Short or Match standard.</p> <ul style="list-style-type: none"> <li>• OPEN: the resistance is infinite so that the standard behaves like a capacitor (no inductance)</li> <li>• SHORT: the resistance is zero so that the standard behaves like an inductance (no capacitance)</li> <li>• MATCH: the standard behaves like a match (no inductance, no capacitance, resistance Z0)</li> </ul> <p>&lt;Resistance&gt; indicates the general load circuit model.</p> |  <p>Character data   Numeric value</p> |
| <Port1>, <Port2>                    | Optional port restriction: one port number for one port standards, two port numbers for two port standards                                                                                                                                                                                                                                                                                                                                                                                                                                                                                                                                                                                                                                                                              | Integer value(s)                                                                                                          |

The different standard types are defined by the following parameters. Port restrictions are indicated in brackets:

Table 6-7: Standard types and their parameters

| <std_type>                                                                       | Maning                                                                                                                     |
|----------------------------------------------------------------------------------|----------------------------------------------------------------------------------------------------------------------------|
| MOPen   FOPen                                                                    | Open: male (m) or female (f)                                                                                               |
| MSHort   FSHort                                                                  | Short: m or f                                                                                                              |
| OShort[<1 2 3>]   MOShort[<1 2 3>]   FOShort[<1 2 3>]                            | Offset short: sexless, m or f (three standards each)<br>For user-defined connector types only!<br>Suffix 1 can be omitted. |
| MMTCh   FMTCh                                                                    | Match: m or f                                                                                                              |
| MSMatch   FSMatch                                                                | Sliding match: m or f                                                                                                      |
| MREFlect   FREFlect                                                              | Reflect: m or f                                                                                                            |
| MMTHrough   MFTHrough   FFTHrough                                                | Through: m-m or m-f or f-f                                                                                                 |
| MMLine[<1 2 3>]   MFLine[<1 2 3>]   FFLine[<1 2 3>]<br>MMLine[<1 2 3>](P2P3) ... | Line: m-m or m-f or f-f (three standards each)<br>Suffix 1 can be omitted.                                                 |
| MMATten   MFATten   FFATten                                                      | Attenuation: m-m or m-f or f-f                                                                                             |
| MMSNetwork   MFSNetwork   FFSNetwork                                             | Symmetric network: m-m or m-f or f-f                                                                                       |

---

**[SENSe:]CORRection:CKIT:DMODE** <ConnectorType>, <CalKitName>, <KitLabel>, <arg3>

Sets/gets the delay mode for the related cal kit (identified by connector type, name and label), i.e allows to toggle between ZVR compatible and Agilent modelling (see "[Offset Parameters](#)" on page 280). Subsequent standard definitions interpret the specified <DelayParam> accordingly.

In "set direction", if a cal kit with the given connector type, name and label is not available on the analyzer, it is created automatically.

Cal kits that are not created/modified using [SENSe:]CORRection:CKIT:DMODE use the ZVR compatible modelling.

**Parameters:**

- <ConnectorType> Name of the connector type. Use [SENSe<Ch>:]CORRection:CONNECTION:CATALOG? to query connector names.
- <CalKitName> String parameter containing the name of the calibration kit. See "Cal kit naming conventions " under [SENSe:]CORRection:CKIT:<ConnType>:LSElect.
- <KitLabel> String parameter containing the label of the calibration kit, usually the serial number.

**Setting parameters:**

- <arg3> DELay | ELENgth  
 DELay – Agilent modelling  
 ELENgth – ZVR compatible modelling

**Manual operation:** See "[Add / Copy / Delete / Standards...](#)" on page 276

---

**[SENSe:]CORRection:CKIT:STANDARD:DATA?** <ConnectorType>, <CalKitName>, <KitLabel>, <StandardType>, <DelayMode>[, <Port1>[, <Port2>]]

Returns the data of the related calibration standard (identified by <ConnectorType>, <CalKitName>, <KitLabel> and <StandardType>) and - optionally - restricted to the given port(s).

The delay parameter is returned according to the selected <DelayMode>; see [Table 6-6](#).

**Query parameters:**

- <ConnectorType> Name of the connector type. Use [SENSe<Ch>:]CORRection:CONNECTION:CATALOG? to query connector names.
- <CalKitName> String parameter containing the name of the calibration kit. See "Cal kit naming conventions " under [SENSe:]CORRection:CKIT:<ConnType>:LSElect.
- <KitLabel> String parameter containing the label of the calibration kit, usually the serial number.

|                    |                                                                                                                                                                                                                                                                                                                                                                                                                                                               |
|--------------------|---------------------------------------------------------------------------------------------------------------------------------------------------------------------------------------------------------------------------------------------------------------------------------------------------------------------------------------------------------------------------------------------------------------------------------------------------------------|
| <StandardType>     | MMTHrough   MFTThrough   FFTHrough   MMLine   MMLine1   MMLine2   MMLine3   MFLine   MFLine1   MFLine2   MFLine3   FFLine   FFLine1   FFLine2   FFLine3   MMATten   MFATten   FFATten   MMSNetwork   MFSNetwork   FFSNetwork   MOPen   FOPen   MSHort   FSHort   MOShort   MOShort1   MOShort2   MOShort3   FOSHort   FOSHort1   FOSHort2   FOSHort3   MREFlect   FRElect   MMTCh   FMTCh   MSMATCH   FSMATCH<br>Standard type; see <a href="#">Table 6-7</a> |
| <DelayMode>        | DELay   ELENgth<br>ELENgth (default) – ZVR compatible modelling<br>DELay – Agilent modelling                                                                                                                                                                                                                                                                                                                                                                  |
| <Port1>[, <Port2>] | Optional port restriction: one port number for one port standards, two port numbers for two port standards                                                                                                                                                                                                                                                                                                                                                    |
| <b>Usage:</b>      | Query only                                                                                                                                                                                                                                                                                                                                                                                                                                                    |

### 6.3.15.5 [SENSe:]CORRection:CKIT... with Labels

The following [SENSe:]CORRection:CKIT... commands identify the calibration kit to be used by a combination of its <CalKitName> and <CalKitLabel>. Typically, the serial number of the calibration kit serves as a calibration kit label. Due to their different labels, the analyzer can handle several calibration kits with identical names.

|                                                                  |     |
|------------------------------------------------------------------|-----|
| [SENSe:]CORRection:CKIT:<ConnType>:LSElect.....                  | 595 |
| [SENSe:]CORRection:CKIT:LCATalog?.....                           | 596 |
| [SENSe:]CORRection:CKIT:LDElete.....                             | 596 |
| [SENSe:]CORRection:CKIT:LLABel.....                              | 597 |
| [SENSe:]CORRection:CKIT:LSElect.....                             | 597 |
| [SENSe:]CORRection:CKIT:STANdard:LCATalog?.....                  | 598 |
| [SENSe:]CORRection:CKIT:<StandardType>:WLABel.....               | 598 |
| [SENSe:]CORRection:CKIT:<OnePortStandardType>:WLABel:SDATa?..... | 599 |
| [SENSe:]CORRection:CKIT:<TwoPortStandard>:WLABel:SDATa?.....     | 599 |

---

#### [SENSe:]CORRection:CKIT:<ConnType>:LSElect <CalKitName>, <Label>

Selects the calibration kit to be used for a specified connector type <ConnType>. The kit is identified by its name and label.

**Tip:** For connector types with arbitrary, user-defined names and labels you can use the command [SENSe:]CORRection:CKIT:LSElect.

#### Suffix:

|            |                                                                                                                                                                                                                                                              |
|------------|--------------------------------------------------------------------------------------------------------------------------------------------------------------------------------------------------------------------------------------------------------------|
| <ConnType> | Connector type, one of the following identifiers:<br>N50, N75 – N 50 Ω or N 75 Ω connectors<br>PC7, PC35, PC292 – PC 7, PC 3.5 or 2.92 mm connectors<br>USER<no> – user-defined connectors UserConn1, UserConn2<br>SMA – user-defined connector type SMA ... |
|------------|--------------------------------------------------------------------------------------------------------------------------------------------------------------------------------------------------------------------------------------------------------------|

**Parameters:**

- <CalKitName> String parameter containing the name of a calibration kit available on the analyzer. See "Cal kit naming conventions " under [\[SENSe:\]CORRection:CKIT:<ConnType>:LSElect](#).
- \*RST: n/a (A \*RST does not change the assignment between connector types and calibration kits.)
- <CalKitLabel> String parameter containing the label of a calibration kit available on the analyzer, usually the serial number.
- \*RST: n/a (A \*RST does not change the assignment between connector types and calibration kits.)

**Example:**

```
MMEM:LOAD:CKIT 'C:\Users\Public
\Documents\Rohde-Schwarz
\Vna\Calibration\Kits\New Kit 1
(123456).calkit'
```

Load the previously created cal kit file  
New Kit 1 (123456).calkit from the default cal kit directory.

```
CORR:CKIT:N50:LSEL 'New Kit 1', '123456'
```

Assign the imported kit to the N 50 Ω connector type, assuming that the cal kit name stored in New Kit 1 (123456).calkit reads New Kit 1 and that its label reads 123456.

**Manual operation:** See ["Add / Copy / Delete / Standards..."](#) on page 276

**[SENSe:]CORRection:CKIT:LCATalog? [<ConnectorType>]**

Returns a list of all cal kits and their labels for a given connector type or for all connector types.

**Query parameters:**

- <ConnectorType> Name of the connector type. Use [\[SENSe<Ch>:\]CORRection:CONNection:CATalog?](#) to query connector names.
- If omitted, the command returns the list of all cal kits and labels.

**Example:** See [\[SENSe<Ch>:\]CORRection:CONNection:CATalog?](#)

**Usage:** Query only

**[SENSe:]CORRection:CKIT:LDElete <CalKitName>, <KitLabel>**

Deletes an imported or user-defined cal kit which is identified by its cal kit name and label.

**Note:** It is not possible to modify or store predefined or ideal kits.

**Setting parameters:**

- <CalKitName> String parameter containing an imported or user-defined calibration kit available on the analyzer.

<KitLabel> String parameter containing the label of an imported or user-defined calibration kit available on the analyzer.

**Example:** See `[SENSe:]CORRection:CKIT:LLABel`

**Usage:** Setting only

**[SENSe:]CORRection:CKIT:LLABel** <CalKitName>, <KitLabel>[, <NewKitLabel>]

Assigns a calibration kit label to an imported or user-defined calibration kit or renames an existing calibration kit label.

**Parameters:**

<CalKitName> String parameter containing an imported or user-defined calibration kit available on the analyzer.

<KitLabel> String parameter containing the current calibration kit label.

<NewKitLabel> String parameter containing the new calibration kit label.

**Example:** `CORR:CKIT:FOP:WLAB 'N 50 Ohm', 'New Kit 1', 'Test kit created today', '', 0, 4000000000, 0, 0, 50, 99, -2.3, 0.22, 0, 0, 0, 0, 0`  
 Create a new cal kit "New Kit 1" labelled "Test kit created today" and assign an open (f) standard for the N 50 Ω connector type with specific properties.

`CORR:CKIT:LLAB 'New Kit 1', 'Test kit created today', '2012-05-25'`

Change the label of the previously created kit.

`CORR:CKIT:LLAB? 'New Kit 1', '2012-05-25'`

Check the label.

`MMEMemory:STORe:CKIT:`

`WLABel 'New Kit 1', '2012-05-25', 'C:`

`\Users\Public\Documents`

`\Rohde-Schwarz\Vna\Calibration\Kits\New Kit 1`

`(2012-05-25).calkit'`

Store the data for the labelled cal kit to the cal kit file

`New Kit 1 (2012-05-25).calkit.`

`CORR:CKIT:LDEL 'New Kit 1', '2012-05-25'`

Delete the kit. from the internal memory.

`MMEMemory:LOAD:CKIT 'C:\Users\Public\Documents`

`\Rohde-Schwarz\Vna\Calibration\Kits\New Kit 1`

`(2012-05-25).calkit'`

Re-load the kit.

**[SENSe:]CORRection:CKIT:LSElect** <ConnectorType>, <CalKitName>, <KitLabel>

Selects the calibration kit to be used, specifying its connector type, name, and label.

**Tip:** The command is suitable for connector types with arbitrary, user-defined names.

For standard connector types you can use the command `[SENSe:]CORRection:`

`CKIT:<ConnType>:LSElect` .

**Parameters:**

|                 |                                                                                       |
|-----------------|---------------------------------------------------------------------------------------|
| <ConnectorType> | Connector type, e.g. a user-defined connector type (string variable).                 |
| <CalKitName>    | String parameter containing the name of a calibration kit available on the analyzer.  |
| <KitLabel>      | String parameter containing the label of a calibration kit available on the analyzer. |

**Example:**

```
MMEM:LOAD:CKIT 'C:\Users\Public
\Documents\Rohde-Schwarz
\Vna\Calibration\Kits\New Kit 1
(123456).calkit'
```

Load the previously created cal kit file

New Kit 1 (123456).calkit from the default cal kit directory.

```
CORR:CKIT:LSEL 'N 50 Ohm', 'New Kit 1',
'123456'
```

Assign the imported kit to the N 50 Ω connector type, assuming that the cal kit name stored in New Kit 1 (123456).calkit reads New Kit 1 and that its label reads 123456.

**[SENSe:]CORRection:CKIT:STANdard:LCATalog? <CalKitName>, <KitLabel>**

Returns a list of all standards in a given calibration kit.

**Query parameters:**

|              |                                                                                                               |
|--------------|---------------------------------------------------------------------------------------------------------------|
| <CalKitName> | Name of the cal kit. Use <a href="#">[SENSe:]CORRection:CKIT:LCATalog?</a> to query cal kit names and labels. |
| <KitLabel>   | Label of the cal kit.                                                                                         |

**Example:** See [\[SENSe<Ch>:\]CORRection:CONNection:CATalog?](#)

**Usage:** Query only

**[SENSe:]CORRection:CKIT:<StandardType>:WLAbel <ConnType>, <CalKitName>, <CalKitLabel>, <StandardLabel>, <MinFreq>, <MaxFreq>, <DelayParam>, <Loss>, <Z0>, <C0>, <C1>, <C2>, <C3>, <L0>, <L1>, <L2>, <L3>, OPEN | SHORt | MATCh | <Resistance>[, <Port1>[, <Port2>]]**  
**[SENSe:]CORRection:CKIT:<StandardType>:WLAbel? <ConnType>[, <CalKitName>[, <CalKitLabel>[, <Port1>[, <Port2>]]]]**

Defines the parameters of a non-ideal 1 port or 2-port calibration standard <StandardType>, where a particular cal kit can be addressed by name **and** label.

Apart from the additional <CalKitLabel> parameter, the syntax and semantics of this command is identical to [Standard types and their parameters](#) .

**Example:**

```
CORR:CKIT:FOP:WLAB 'N 50 Ohm', 'New Kit
1', '123456', '',
0, 4000000000, 0, 0, 50, 99, -2.3, 0.22, 0, 0, 0, 0, 0
Define the properties of the Open (f) standard for a N 50 Ω con-
nector type in the calibration kit "New Kit 1" labelled "123456".
CORR:CKIT:FOP:WLAB? 'N 50 Ohm', 'New Kit 1',
'123456'
Query the properties of the Open (f) standard for a N 50 Ω con-
nector type in the calibration kit.
```

**Manual operation:** See "[Add / Copy / Delete / View / Modify...](#)" on page 279

---

**[SENSe:]CORRection:CKIT:<OnePortStandardType>:WLAbel:SDATa?**  
 <ConnectorType>, <CalKitName>[, <CalKitLabel>[, <PhysPort>]]

Reads the S-parameter data for a particular **1-port** cal kit standard previously loaded from Touchstone file using `MMEMory:LOAD:CKIT:SDATa` or `MMEMory:LOAD:CKIT:SDATa:WLAbel`.

The cal kit is identified by its name and label.

**Query parameters:**

<OnePort  
 StandardType> MOPen | FOPen | MSHort | FSHort | MOShort | MOShort1 |  
 MOShort2 | MOShort3 | FOSHort | FOSHort1 | FOSHort2 |  
 FOSHort3 | MREFlect | FRElect | MMTCh | FMTCh |  
 MSMatch | FSMatch  
 Standard type.  
 For more information see [Table 6-7](#).

<ConnectorType>,  
 <CalKitName>,  
 <CalKitLabel> Together with <StandardType> these parameters fully identify  
 the related standard (see [Parameter list](#)).

<PhysPort> Number of the physical port for which the S-parameter data is  
 valid. Can be omitted if the data are valid for all ports.

**Usage:** Query only

---

**[SENSe:]CORRection:CKIT:<TwoPortStandard>:WLAbel:SDATa?**  
 <ConnectorType>, <CalKitName>[, <CalKitLabel>[, <SParameter>,  
 <PhysPort1>, <PhysPort2>]]

Reads the S-parameter data for a particular **2-port** cal kit standard previously loaded from Touchstone file using `MMEMory:LOAD:CKIT:SDATa` or `MMEMory:LOAD:CKIT:SDATa:WLAbel`.

The cal kit is identified by its name and label.

**Query parameters:**

|                                                    |                                                                                                                                                                                                                                                                                                       |
|----------------------------------------------------|-------------------------------------------------------------------------------------------------------------------------------------------------------------------------------------------------------------------------------------------------------------------------------------------------------|
| <TwoPortStandard>                                  | MMTHrough   MFTHrough   FFTHrough   MMLine   MMLine1   MMLine2   MMLine3   MFLine   MFLine1   MFLine2   MFLine3   FFLine   FFLine1   FFLine2   FFLine3   MMATten   MFATten   FFATten   MMSNetwork   MFSNetwork   FFSNetwork<br>Standard type.<br>For more information see <a href="#">Table 6-7</a> . |
| <ConnectorType>,<br><CalKitName>,<br><CalKitLabel> | Together with <StandardType> these parameters fully identify the related standard (see <a href="#">Parameter list</a> ).                                                                                                                                                                              |
| <SParameter>                                       | S11   S12   S21   S22<br>S-parameter of the 2-port standard.                                                                                                                                                                                                                                          |
| <PhysPort1>,<br><PhysPort2>                        | Numbers of the physical ports for which the S-parameter data is valid. Can be omitted if the data are valid for all port pairs.                                                                                                                                                                       |
| <b>Usage:</b>                                      | Query only                                                                                                                                                                                                                                                                                            |

**6.3.15.6 [SENSe:]CORRection...**

The [SENSe:]CORRection... commands control the system error correction and measurement receiver (power) calibration.



For a unidirectional R&S ZND (see [Chapter 3.1.4.2, "R&S ZND: Unidirectional vs. Bidirectional Operation"](#), on page 16) automatic calibration is not supported and hence the [SENSe:]CORRection:COLLect:AUTO commands are not available.

|                                                        |     |
|--------------------------------------------------------|-----|
| [SENSe<Ch>:]CORRection:COLLect[:ACQUIRE]:SELected..... | 601 |
| [SENSe<Ch>:]CORRection:COLLect:AUTO.....               | 603 |
| [SENSe:]CORRection:COLLect:AUTO:CKIT.....              | 604 |
| [SENSe:]CORRection:COLLect:AUTO:CKIT:PASSword.....     | 605 |
| [SENSe:]CORRection:COLLect:AUTO:CKIT:PORTs.....        | 606 |
| [SENSe:]CORRection:COLLect:AUTO:CKIT:PORTs:ADD.....    | 607 |
| [SENSe<Ch>:]CORRection:COLLect:AUTO:PORTs.....         | 608 |
| [SENSe:]CORRection:COLLect:AUTO:PORTs:CONNection?..... | 608 |
| [SENSe<Ch>:]CORRection:COLLect:AUTO:PORTs:TYPE.....    | 609 |
| [SENSe<Ch>:]CORRection:COLLect:AUTO:POWer.....         | 610 |
| [SENSe<Ch>:]CORRection:COLLect:AUTO:TYPE.....          | 611 |
| [SENSe:]CORRection:COLLect:AVERAge.....                | 612 |
| [SENSe:]CORRection:COLLect:CHANnels:ALL.....           | 612 |
| [SENSe:]CORRection:COLLect:CHANnels:MCTYPES.....       | 613 |
| [SENSe<Ch>:]CORRection:COLLect:CONNection<PhyPt>.....  | 614 |
| [SENSe<Ch>:]CORRection:COLLect:CONNection:GENDeRs..... | 615 |
| [SENSe<Ch>:]CORRection:COLLect:CONNection:PORTs.....   | 616 |
| [SENSe<Ch>:]CORRection:COLLect:DELeTe.....             | 616 |
| [SENSe<Ch>:]CORRection:COLLect:FIXTure[:ACQUIRE].....  | 617 |
| [SENSe<Ch>:]CORRection:COLLect:FIXTure:EXPort.....     | 618 |
| [SENSe<Ch>:]CORRection:COLLect:FIXTure:IMPort.....     | 618 |



|                                                                   |     |
|-------------------------------------------------------------------|-----|
| [SENSe:]CORRection:COLLect:FIXTure:LMPParameter:LOSS[:STATe]..... | 619 |
| [SENSe:]CORRection:COLLect:FIXTure:LMPParameter[:STATe].....      | 620 |
| [SENSe<Ch>:]CORRection:COLLect:FIXTure:SAVE.....                  | 620 |
| [SENSe<Ch>:]CORRection:COLLect:FIXTure:START.....                 | 620 |
| [SENSe<Ch>:]CORRection:COLLect:LOAD:SElected.....                 | 621 |
| [SENSe<Ch>:]CORRection:COLLect:METHod:DEFine.....                 | 622 |
| [SENSe:]CORRection:COLLect:PMETer:ID.....                         | 624 |
| [SENSe<Ch>:]CORRection:COLLect:SAVE:SElected:DEFault.....         | 624 |
| [SENSe<Ch>:]CORRection:COLLect:SAVE:SElected[:DUMMy].....         | 625 |
| [SENSe<Ch>:]CORRection:COLLect:SCONnection<PhyPt>.....            | 626 |
| [SENSe<Ch>:]CORRection:CONNection.....                            | 626 |
| [SENSe<Ch>:]CORRection:CONNection:CATalog?.....                   | 627 |
| [SENSe<Ch>:]CORRection:CONNection:DELete.....                     | 628 |
| [SENSe<Ch>:]CORRection:DATA:PARAmeter<Sfk>?.....                  | 628 |
| [SENSe<Ch>:]CORRection:DATA:PARAmeter:COUNT?.....                 | 631 |
| [SENSe<Ch>:]CORRection:DATE?.....                                 | 631 |
| [SENSe<Ch>:]CORRection:EDELay<PhyPt>:AUTO.....                    | 632 |
| [SENSe<Ch>:]CORRection:EDELay<PhyPt>:DIElectric.....              | 633 |
| [SENSe<Ch>:]CORRection:EDELay<PhyPt>:DISTance.....                | 633 |
| [SENSe<Ch>:]CORRection:EDELay<PhyPt>:ELEngth.....                 | 633 |
| [SENSe<Ch>:]CORRection:EDELay<PhyPt>[:TIME].....                  | 634 |
| [SENSe<Ch>:]CORRection:LOSS<PhyPt>.....                           | 634 |
| [SENSe<Ch>:]CORRection:LOSS<PhyPt>:AUTO.....                      | 635 |
| [SENSe<Ch>:]CORRection:LOSS<PhyPt>:FREQUency.....                 | 635 |
| [SENSe<Ch>:]CORRection:LOSS<PhyPt>:OFFSet.....                    | 635 |
| [SENSe<Ch>:]CORRection:OFFSet<PhyPt>[:STATe].....                 | 636 |
| [SENSe<Ch>:]CORRection:OFFSet<PhyPt>:COMPensation[:STATe].....    | 636 |
| [SENSe<Ch>:]CORRection:OFFSet<PhyPt>:DFComp[:STATe]?.....         | 637 |
| [SENSe<Ch>:]CORRection:POWer<PhyPt>:ACQuire.....                  | 637 |
| [SENSe<Ch>:]CORRection:PCAL.....                                  | 638 |
| [SENSe<Ch>:]CORRection:POWer<PhyPt>:AWAVe[:STATe].....            | 639 |
| [SENSe<Ch>:]CORRection:POWer:DATA.....                            | 639 |
| [SENSe<Ch>:]CORRection:POWer<PhyPt>[:STATe].....                  | 640 |
| [SENSe<Chn>:]CORRection:SState?.....                              | 641 |
| [SENSe<Ch>:]CORRection[:STATe].....                               | 641 |
| [SENSe<Ch>:]CORRection:STIMulus?.....                             | 642 |
| [SENSe<Chn>:]CORRection:PSState?.....                             | 642 |

---

**[SENSe<Ch>:]CORRection:COLLect[:ACQuire]:SElected** <Type>, <TestPort>[,  
<SecondPortOrAdapter>, <Dispersion>, <DelayTimePhase>]

Starts the acquisition of measurement data for the selected standard and port(s). The standards are reflection or transmission standards and can be connected to arbitrary analyzer ports.

**Note:**

- The calibration measurement has a variable timeout:  $Timeout = (Sweep\ time / Number\ of\ sweep\ points) * 3 + 0.1\ s$

The timeout may be reached e.g. while the measurement waits for the specified trigger event. It is used for all standard measurements including power calibration sweeps (for SMARTerCal).

- For a sliding match, the R&S ZNC/ZND can acquire measurement data for up to 20 positions per port. Multiple calls of `[SENSe<Ch>:]CORREction:COLLect[:ACQuire]:SELEcted SLIDe, <TestPort>` for the same test port, implicitly increases the position until position 20 has been recorded. Subsequent calls will start over at position 1, overwriting the previously acquired data.

**Suffix:**

<Ch> Channel number of the calibrated channel

**Setting parameters:**

<Type> THROUGH | OPEN | SHORT | OSHort | OSHort1 | OSHort2 | OSHort3 | MATCH | NET | ATT | REFL | SLIDe | ISOLation | LINE | LINE1 | LINE2 | LINE3 | UTHRough | POWer

Standard types: Through, Open, Short, Match, Symmetric Network (NET), Attenuation (ATT), Reflect, Sliding Match (SLIDe), Line1 (LINE1 and LINE are synonymous), Line2 and Line3 (esp. for TRL calibration), Offset Short 1 to 3 (OShort), Unknown Through, power meter (for SMARTerCal).  
ISOLation is not a physical standard: to measure the isolation (supported for transmission normalization and TOSM only!) it is recommended to suitably terminate the related test ports (e.g. with 50 Ω loads).

<TestPort> Test port number. For a transmission standard (through, line, attenuation, symmetric network) or an adapter used as a "through" the input and output port numbers must be specified. For reflection standards, only one port number is required.

\*RST: n/a

<SecondPortOrAdapter> For a transmission standard or an adapter used as a "through" this parameter specifies the second test port. For reflection measurements with an adapter connected between port and standard, set it to ON. Otherwise set it to OFF or simply omit it.

<Dispersion> Optional status parameter for UTHRough standard:  
OFF - unknown through standard is non-dispersive.  
ON - unknown through standard is dispersive.

\*RST: OFF

<DelayTimePhase> Optional entry of delay time or phase for UTHRough standard: AUTO - the analyzer determines the delay time or phase during the calibration sweep.  
 <delay or phase> - entry of the delay time in ps (for non-dispersive standards) or of the phase at the start frequency of the sweep in deg (for dispersive standards). If an estimate of the start phase is entered, the analyzer uses the **calculated** value which is closest to the estimate.

#### Automatic determination of the phase

The UOSM algorithm provides the transmission factor of the unknown through standard up to an ambiguous sign. This yields the two alternative phase values displayed in the calibration wizard; see Unknown Through Standard.

In remote control, the analyzer performs a plausibility check in order to determine the correct phase. No manual selection is necessary. The check starts at the first sweep point, using the transmission factor with negative phase. The analyzer measures the phase at the subsequent sweep points, assuming that the phase difference between any two consecutive points is less than 90 deg. From these phase values, the analyzer calculates a linear extrapolation and derives an estimate for the DC phase limit. If this DC phase is in the vicinity of ... -180 deg, +180 deg, ... then the transmission factor with negative phase is adopted. If the DC phase is in the vicinity of ... 0 deg, +360 deg, ... then the transmission factor with inverted sign (corresponding to a 180 deg phase shift) is adopted.

\*RST: AUTO

**Example:** See [SENSe<Ch>:]CORRection:COLLect:SAVE:SELected[:DUMMy] or [Chapter 7.2.5.3, "Adapter Removal"](#), on page 797

**Usage:** Setting only

**Manual operation:** See ["Ports and Standards"](#) on page 266

---

[SENSe<Ch>:]CORRection:COLLect:AUTO <Characterization>, <TestPort>, <TestPort>...

Selects and initiates an automatic calibration for the specified test ports using a single, auto-detected port assignment.

#### Tip:

- If the test setup contains a high attenuation, the analyzer may fail to detect the cal unit ports connected to each of its ports. In this case use the extended command [SENSe<Ch>:]CORRection:COLLect:AUTO:PORTs.
- Use [SENSe<Ch>:]CORRection:COLLect:AUTO:TYPE if you want to specify a particular calibration type for the automatic calibration.
- If several calibration units are connected, use SYSTem:COMMunicate:RDEvice:AKAL:ADDRESS to select a unit for the calibration.

**Suffix:**

<Ch> Channel number of the calibrated channel

**Setting parameters:**

<Characterization> Location of the characterization (cal kit file) to be used for the automatic calibration (string parameter):

- If an empty string ( ' ' ) is specified, the factory cal kit file stored in the active calibration unit is used.
- A VNA cal kit file name `*.calkit` without path refers to a specific cal kit file stored in the internal memory of the active calibration unit.
- A VNA cal kit file name without path but prefixed with "SD:" refers to a specific cal kit file stored on the SD card inserted at the active calibration unit.
- A VNA cal kit file name `*.calkit` with path refers to a specific cal kit file stored in an arbitrary directory on the analyzer.

<TestPort>

<TestPort> Test port numbers. For an n-port automatic calibration, n arbitrary (not necessarily consecutive) port numbers must be specified. The analyzer automatically detects the calibration unit ports connected to each analyzer port.

**Example:**

```
CORR:COLL:AUTO '', 1, 2, 4
```

Perform an automatic 3-port calibration at test ports 1, 2, and 4 using the calibration unit's default calibration kit file and arbitrary test ports of the cal unit.

**Usage:**

Setting only

**Manual operation:** See ["Apply/Cancel"](#) on page 260

**[SENSe:]CORRection:COLLect:AUTO:CKIT <Characterization>**

Generates a characterization (cal kit file) with the specified name containing the cal kit data of the active calibration unit (selected via `SYSTem:COMMunicate:RDEvice:AKAL:ADDReSS`). The cal kit file can be saved to a directory on the analyzer, to the calibration unit's internal (flash) memory or to an SD card inserted at the calibration unit (if available).

**Note** that this command can only be executed if the number of cal unit ports is less or equal to the number of test ports. Furthermore the command assumes the "canonical" assignment of cal unit ports to test ports: cal unit port 1 assigned to test port 1, cal unit port 2 assigned to test port 2 etc. The new command `[SENSe:]CORRection:COLLect:AUTO:CKIT:PORTs` allows for flexible assignments.

**Setting parameters:**

<Characterization> Location of the created characterization / cal kit file (string parameter, extension \*.calkit):  
 If a path is specified, the file is saved to the analyzer's hard disk. The default directory (MMEMory:CDIRectory) is **not** used.  
 If only the file name is specified, the file is saved to the calibration unit's internal (flash) memory. The factory calibration data on the unit is not overwritten.  
 If the file name is prefixed by "SD:", the file is saved to the SD card inserted at the calibration unit (if available/accessible).

**Example:**

```
CORR:COLL:AUTO:CKIT 'AutoCalChar'
```

Generate a cal kit file `AutoCalChar.calkit` for the active calibration unit and store it in the calibration unit.

```
SENSe:CORRection:COLLect:AUTO:CKIT 'SD:test1'
```

Generate a cal kit file `test1.calkit` for the active calibration unit and store it in the calibration unit.

**Usage:** Setting only

**Manual operation:** See "[Filename / Comment](#)" on page 285

**[SENSe:]CORRection:COLLect:AUTO:CKIT:PASSword <Password>**

Enters a password to enable a single password-protected action in the automatic calibration or in the characterization wizard. If password protection has been activated manually in the "Characterize Cal Unit" dialog, the password is required for any single execution of one of the following commands, provided that a cal kit (characterization) file different from the active characterization is specified:

```
[SENSe]:CORRection:COLLect:AUTO
[SENSe]:CORRection:COLLect:AUTO:CKIT
[SENSe]:CORRection:COLLect:AUTO:PORTs
[SENSe]:CORRection:COLLect:AUTO:PORTs:TYPE
[SENSe]:CORRection:COLLect:AUTO:TYPE
```

**Tip:** You have to send `[SENSe:]CORRection:COLLect:AUTO:CKIT:PASSword` repeatedly if your command script uses several password-protected commands. You do not need a password to perform automatic calibrations using the active cal unit characterization.

**Setting parameters:**

<Password> Password (string parameter), as defined in manual control.

**Example:**

```
SENSe:CORRection:COLLect:AUTO:CKIT:PASSword
'My_password'
```

Enter a password `My_password` (assuming that password protection has been activated manually).

```
SENSe:CORRection:COLLect:AUTO '', 1, 2
```

Perform an automatic 2-port calibration at test ports 1 and 2 using the calibration unit's default calibration kit file and automatic port assignment.

```
SENSe:CORRection:COLLect:AUTO:CKIT:PASSword
'My_password'
```

Re-enter the password.

```
SENSe:CORRection:COLLect:AUTO '', 1, 2
```

Repeat the calibration.

**Usage:** Setting only

**Manual operation:** See "[Authentication / Set Password](#)" on page 282

---

**[SENSe:]CORRection:COLLect:AUTO:CKIT:PORTs** <Characterization>, <TestPort1>, <CalUnitPort1>, <TestPort2>...

Generates a characterization (cal kit file) with the specified name containing the cal kit data of the active calibration unit (`SYSTem:COMMunicate:RDEvice:AKAL:ADDRes`). The cal kit file can be saved to a directory on the analyzer, to the calibration unit's internal (flash) memory or to an SD card inserted at the calibration unit (if available).

Similar logic as `[SENSe:]CORRection:COLLect:AUTO:CKIT`, but with flexible port assignment.

**Setting parameters:**

<Characterization> Location of the created characterization / cal kit file (string parameter, extension \*.calkit):  
 If a path is specified, the file is saved to the analyzer's hard disk. The default directory (`MMEMory:CDIRectory`) is **not** used.  
 If only the file name is specified, the file is saved to the calibration unit's internal (flash) memory. The factory calibration data on the unit is not overwritten.  
 If the file name is prefixed by "SD:", the file is saved to the SD card inserted at the calibration unit (if available/accessible).

<TestPort1> Number of first test port.

<CalUnitPort1> Number of the calibration unit port to whom the first test port (<TestPort1>) is assigned.

<TestPort2> Number of second test port...

**Usage:** Setting only

**Manual operation:** See "[Test Port Assignment](#)" on page 284

**[SENSe:]CORRection:COLLect:AUTO:CKIT:PORTs:ADD** <Characterization>,  
<TestPort1>, <CalUnitPort1>, <TestPort2>...

Extends or modifies an *existing* characterization of the active calibration unit (**SYSTem:COMMunicate:RDEvice:AKAL:ADDRESS**).

This functionality is not available at the GUI.

**Setting parameters:**

<Characterization> Location of an existing characterization (e.g. created using **[SENSe:]CORRection:COLLect:AUTO:CKIT:PORTs**).  
 – A VNA cal kit file name \*.calkit without path refers to a specific cal kit file stored in the internal memory of the active calibration unit.  
 – A VNA cal kit file name without path but prefixed with "SD:" refers to a specific cal kit file stored on the SD card inserted at the active calibration unit.  
 – A VNA cal kit file name \*.calkit with path refers to a specific cal kit file stored in an arbitrary directory on the analyzer.

<TestPort1> Number of first test port.

<CalUnitPort1> Number of the calibration unit port, to whom test port <TestPort1> is assigned.

<TestPort2> Number of the second test port ...

**Example:**

Prerequisite:

```
SYSTem:COMMunicate:RDEvice:AKAL:ADDRESS
'MyCalU'
```

Sets 'MyCalU' as the active calibration unit.

```
SYSTem:COMMunicate:RDEvice:AKAL:PORTs? 'abc'
```

Queries the ports of characterization 'abc'; returns something like '3,N 50 Ohm,MALE,4,N 50 Ohm,MALE'. In particular, calibration unit ports 1 and 2 are not yet characterized.

```
SENSe:CORRection:COLLect:AUTO:CKIT:PORTs:ADD
'abc',1,2
```

Extend characterization 'abc' with test port 1 assigned to port 2 of the cal unit.

```
SYSTem:COMMunicate:RDEvice:AKAL:PORTs? 'abc'
```

Now returns something like '2,N 50 Ohm,MALE,3,N 50 Ohm,MALE,4,N 50 Ohm,MALE'.

```
SENSe:CORRection:COLLect:AUTO:CKIT:PORTs:ADD
'abc',1,2
```

Repeat characterization of test port 2, e.g. because the connection cable wasn't fastened correctly ...

**Usage:**

Setting only

---

**[SENSe<Ch>:]CORRection:COLLect:AUTO:PORTs** <Characterization>, <TestPort1>, <CalUnitPort1>, <TestPort2>...

Selects and initiates an automatic calibration at arbitrary analyzer and calibration unit ports. A progress monitor for the calibration sweeps is displayed.

**Tip:** This command is necessary if the analyzer fails to detect the cal unit ports connected to each of its ports (e.g. because of a high attenuation in the test setup). If auto-detection works you can use the simpler command `[SENSe<Ch>:]CORRection:COLLect:AUTO`.

**Suffix:**

<Ch> Channel number of the calibrated channel

**Setting parameters:**

<Characterization> Location of the characterization (cal kit file) to be used for the automatic calibration (string parameter):

- If an empty string ( ' ' ) is specified, the factory cal kit file stored in the active calibration unit is used.
- A VNA cal kit file name `*.calkit` without path refers to a specific cal kit file stored in the internal memory of the active calibration unit.
- A VNA cal kit file name without path but prefixed with "SD:" refers to a specific cal kit file stored on the SD card inserted at the active calibration unit.
- A VNA cal kit file name `*.calkit` with path refers to a specific cal kit file stored in an arbitrary directory on the analyzer.

<TestPort1> Test port numbers. For an n-port automatic calibration, n arbitrary (not necessarily consecutive) port numbers must be specified.

<CalUnitPort1> Port numbers of the cal unit. For an n-port automatic calibration, n arbitrary (not necessarily consecutive) port numbers must be specified. It is possible to combine arbitrary (not necessarily matching) pairs of analyzer and cal unit ports.

<TestPort2>

**Example:**

`CORR:COLL:AUTO:PORT ' ', 1, 2, 2, 4, 4, 1`  
 Perform an automatic 3-port calibration at the analyzer test ports 1, 2, and 4 using the calibration unit's default calibration kit file and ports 2, 4, and 1 of the cal unit.

**Usage:** Setting only

**Manual operation:** See "[Apply/Cancel](#)" on page 260

---

**[SENSe:]CORRection:COLLect:AUTO:PORTs:CONNection?**

Returns the assignment between the network analyzer ports and the ports of the connected automatic calibration unit.



- Example:** `CORR:COLL:AUTO:PORT '', 1, 2, 2, 4, 4, 1`  
 Perform an automatic 3-port calibration at the analyzer test ports 1, 2, and 4 using the calibration unit's default calibration kit file and ports 2, 4, and 1 of the cal unit.
- `CORR:COLL:AUTO:PORT:CONN?`  
 Query the actual port assignment. If the cal unit is properly connected according to the previous command, the response is 1,2,2,4,3,0,4,1. A zero means that the corresponding analyzer port is not connected to any port of the calibration unit.
- Usage:** Query only
- Manual operation:** See "[Detect Port Assignment](#)" on page 258

---

**[SENSe<Ch>:]CORRection:COLLect:AUTO:PORTs:TYPE <CalType>[, <Characterization>, <TestPort1>, <CalUnitPort1>, <TestPort2>...]**

Selects and initiates an automatic calibration at arbitrary test and calibration unit ports. A progress monitor for the calibration sweeps is displayed.

**Tip:** This command is necessary if the analyzer fails to detect the cal unit ports connected to each of its ports (e.g. because of a high attenuation in the test setup). If auto-detection works you can use the simpler command `[SENSe<Ch>:]CORRection:COLLect:AUTO:TYPE`.

**Suffix:**

<Ch> Channel number of the calibrated channel

**Setting parameters:**

- <CalType> FNPort | FOPort | OPTPort | FRTRans | FTRans | RTRans | UTRans | REFL | RSHort | PFNPort
- FNPort - full n-port (UOSM) calibration  
 FOPort - full one-port ("Refl OSM") calibration  
 OPTPort - one path two ports calibration  
 SFTPort - separate full two-port calibration (UOSM calibration at two ports)  
 PFNPort – for future extensions
- <Characterization> Location of the characterization (cal kit file) to be used for the automatic calibration (string parameter):
- If an empty string ( ' ' ) is specified, the factory cal kit file stored in the active calibration unit is used.
  - A VNA cal kit file name \*.calkit without path refers to a specific cal kit file stored in the internal memory of the active calibration unit.
  - A VNA cal kit file name without path but prefixed with "SD:" refers to a specific cal kit file stored on the SD card inserted at the active calibration unit.
  - A VNA cal kit file name \*.calkit with path refers to a specific cal kit file stored in an arbitrary directory on the analyzer.

|                          |                                                                                                                                                                                                                                                                                                                        |
|--------------------------|------------------------------------------------------------------------------------------------------------------------------------------------------------------------------------------------------------------------------------------------------------------------------------------------------------------------|
| <TestPort1>              | Test port number. For an n-port automatic calibration, n arbitrary (not necessarily consecutive) port numbers must be specified. For a one path two port calibration (OPTPort), the first port no. denotes the source port (fully calibrated port).                                                                    |
| <CalUnitPort1>           | Port numbers of the cal unit. For an n-port automatic calibration, n arbitrary (not necessarily consecutive) port numbers must be specified. It is possible to combine arbitrary (not necessarily matching) pairs of analyzer and cal unit ports.                                                                      |
| <TestPort2>              | Second test port number<br>*RST: n/a                                                                                                                                                                                                                                                                                   |
| <b>Example:</b>          | <pre>CORR:COLL:AUTO:PORT FNPort, ', 1, 2, 2, 4, 4, 1</pre> <p>Perform an automatic full 3-port calibration at test ports 1, 2, and 4 using the calibration unit's default calibration kit file and ports 2, 4, and 1 of the cal unit.<br/>See also <a href="#">[SENSe&lt;Ch&gt;:]CORRection:COLLect:AUTO:POWeR</a></p> |
| <b>Usage:</b>            | Setting only                                                                                                                                                                                                                                                                                                           |
| <b>Manual operation:</b> | See " <a href="#">Calibration Type / Source</a> " on page 256                                                                                                                                                                                                                                                          |

---

#### [SENSe<Ch>:]CORRection:COLLect:AUTO:POWeR <TestPort>

Initiates a receiver power calibration at the analyzer port <Port>. This is the second step of an automatic SMARTerCal.

**Note:** The power calibration must be performed "after" the system error correction; see example below.

**Suffix:**

<Ch> Channel number of the calibrated channel

**Setting parameters:**

<TestPort> Test port number. The port number must match the port number selected via [\[SENSe:\]CORRection:COLLect:PMETer:ID](#); see example.

- Example:** Suppose that a power meter no. 1 is configured and USB-connected to the analyzer.  
`SENSe:CORRection:COLLect:PMETer:ID 1, 2`  
 Select power meter no. 1, to be connected to Port 2, for the SMARTerCal.  
 --> Connect the calibration unit between ports 1 and 2 of the analyzer,  
`SENSe:CORRection:COLLect:AUTO:PORTs:TYPE`  
`PFNPort, '', 1, 1, 2, 2`  
 Perform an automatic full 2-port (UOSM) calibration at the analyzer test ports 1 and 2 using the calibration unit's default calibration kit file and default port assignments (ports 1 and 2 of the cal unit).  
 --> Remove the cal unit and connect the power meter to Port 2 of the analyzer.  
`SENSe:CORRection:COLLect:AUTO:POWer 2`  
 Perform an additional receiver power calibration at Port 2. This completes the
- Usage:** Setting only

---

**[SENSe<Ch>:]CORRection:COLLect:AUTO:TYPE <CalType>[, <Characterization>, <TestPort1>, <TestPort2>...]**

Selects and initiates an automatic calibration at arbitrary analyzer and cal unit ports. This command also selects the calibration type. A progress monitor for the calibration sweeps is displayed.

**Tip:** If the test setup contains a high attenuation the analyzer may fail to detect the cal unit ports connected to each of its ports. In this case use the extended command `[SENSe<Ch>:]CORRection:COLLect:AUTO:PORTs:TYPE`.

If several calibration units are connected, use `SYSTem:COMMunicate:RDEvice:AKAL:ADDRess` to select a unit for the calibration.

**Suffix:**

<Ch> Channel number of the calibrated channel

**Setting parameters:**

<CalType> FNPort | FOPort | OPTPort | FRTRans | FTRans | RTRans | UTRans | REFL | RSHort | PFNPort  
 FNPort – full n-port (UOSM) calibration  
 FOPort – full one-port ("Refl OSM") calibration  
 SFTPPort – separate full two-port calibrations  
 OPTPort – one path two ports calibration  
 PFNPort – for future extensions

|                                 |                                                                                                                                                                                                                                                                                                                                                                                                                                                                                                                                                                                                                                                                                                                                                                                          |
|---------------------------------|------------------------------------------------------------------------------------------------------------------------------------------------------------------------------------------------------------------------------------------------------------------------------------------------------------------------------------------------------------------------------------------------------------------------------------------------------------------------------------------------------------------------------------------------------------------------------------------------------------------------------------------------------------------------------------------------------------------------------------------------------------------------------------------|
| <b>&lt;Characterization&gt;</b> | <p>Location of the characterization (cal kit file) to be used for the automatic calibration (string parameter):</p> <ul style="list-style-type: none"> <li>– The empty string ( ' ' ) refers to the factory calibration of (and stored on) the active calibration unit.</li> <li>– A VNA cal kit file name <code>*.calkit</code> without path refers to a specific cal kit file stored in the internal memory of the active calibration unit.</li> <li>– A VNA cal kit file name without path but prefixed with "SD:" refers to a specific cal kit file stored on the SD card inserted at the active calibration unit.</li> <li>– A VNA cal kit file name <code>*.calkit</code> with path refers to a specific cal kit file stored in an arbitrary directory on the analyzer.</li> </ul> |
| <b>&lt;TestPort1&gt;</b>        | <p>Test port numbers. For an n-port automatic calibration, n arbitrary (not necessarily consecutive) port numbers must be specified. For a one path two port calibration (OPTPort), the first port no. denotes the node port (fully calibrated port).</p>                                                                                                                                                                                                                                                                                                                                                                                                                                                                                                                                |
| <b>&lt;TestPort2&gt;</b>        | <p>Second test port number of the analyzer</p>                                                                                                                                                                                                                                                                                                                                                                                                                                                                                                                                                                                                                                                                                                                                           |
| <b>Example:</b>                 | <pre>CORR:COLL:AUTO:TYPE FNPort, '', 1, 2, 4</pre> <p>Perform an automatic full 3-port calibration at test ports 1, 2, and 4 using the calibration unit's default calibration kit file and arbitrary test ports of the cal unit.</p>                                                                                                                                                                                                                                                                                                                                                                                                                                                                                                                                                     |
| <b>Usage:</b>                   | <p>Setting only</p>                                                                                                                                                                                                                                                                                                                                                                                                                                                                                                                                                                                                                                                                                                                                                                      |
| <b>Manual operation:</b>        | <p>See "<a href="#">Calibration Type / Source</a>" on page 256</p>                                                                                                                                                                                                                                                                                                                                                                                                                                                                                                                                                                                                                                                                                                                       |

---

#### **[SENSe:]CORRection:COLLect:AVERage <Average>**

Activates automatic averaging, which means that the VNA may perform multiple calibration sweeps and apply averaging to reduce trace noise. In contrast to manual averaging (see [\[SENSe<Ch>:\]AVERage\[:STATe\]](#)) the number of calibration sweeps is calculated automatically.

#### **Parameters:**

<Average>            AUTO | MANual

**Manual operation:** See "[Auto Averaging](#)" on page 335

---

#### **[SENSe:]CORRection:COLLect:CHANnels:ALL <Boolean>**

Enables calibration of all channels in the active recall set. The command is valid for the following calibration methods:

- Manual system error correction
- Automatic system error correction (cal unit)

A scalar power calibration is not affected.

#### **Parameters:**

<Boolean>            ON – calibrate all channels.  
                           OFF – calibrate the active channel only.

**Example:** See `[SENSe<Ch>:]CORRection:COLLect:SAVE:SELected[:DUMMy]`

**Manual operation:** See "Calibrate all Channels" on page 257

---

**[SENSe:]CORRection:COLLect:CHANnels:MCTYpes <Boolean>**

Toggles the **Multiple Calibration TYpes** mode that allows calibrate a subset of the available channels using channel-specific ports and calibration types (see [Chapter 3.5.7, "Parallel Calibration of Multiple Channels"](#), on page 102).

Enable the MCTYpes mode before defining the calibrations to be performed (using `[SENSe<Ch>:]CORRection:COLLect:METHod:DEFine`, disable it after the calibrations were saved (using `[SENSe<Ch>:]CORRection:COLLect:SAVE:SELected[:DUMMy]` *once*). Also make sure to call `SENSe<Ch>:CORRection:COLLect:SAVE:SELected` with `<Ch>` pointing to one of the calibrated channels.

**Parameters:**  
<Boolean>

**Example:**

Suppose there are 3 channels in the current recall set and you want to calibrate channels 1 and 2. For channel 1 you want to perform a Reflection Normalization (Short) on ports 1 and 2, for channel 2 an OSM calibration on port 2. This requires measuring standards as shown in the table below. Proceed as follows:

```
:CORRection:COLLect:CHANnels:MCTYPes ON
```

Activate the MCTYPes mode.

```
:SENSe1:CORRection:COLLect:METHod:DEFine
```

```
'Parser Test SFK Ch1', RSHort, 1, 2
```

```
:SENSe2:CORRection:COLLect:METHod:DEFine
```

```
'Parser Test SFK Ch2', FOPort, 2
```

Declare the calibrations to be performed, then connect the Short standard to port 1

```
:SENSe1:CORRection:COLLect:ACQuire:SElected
```

```
SHORT, 1
```

Acquire calibration data for channel 1, then connect the Open standard to port 2

```
:SENSe2:CORRection:COLLect:ACQuire:SElected
```

```
OPEN, 2
```

Acquire calibration data for channel 2, then connect the Short standard to port 2

```
:SENSe1:CORRection:COLLect:ACQuire:SElected
```

```
SHORT, 2
```

```
:SENSe2:CORRection:COLLect:ACQuire:SElected
```

```
SHORT, 2
```

Acquire calibration data for channel 1 and 2, then connect the Match standard to port 2

```
:SENSe2:CORRection:COLLect:ACQuire:SElected
```

```
MATCh, 2
```

Acquire calibration data for channel 2

```
:SENSe1:CORRection:COLLect:SAVE:SElected
```

Complete all calibrations. This command is required only once and has to address one of the calibrated channels (channel 1 or 2 in this example)

```
:CORRection:COLLect:CHANnels:MCTYPes OFF
```

Deactivate the MCTYPes mode. Recommended for compatibility with manual operation!

|                                                                          | Port 1 | Port 2             |
|--------------------------------------------------------------------------|--------|--------------------|
| <b>Channel 1</b><br>Reflection Normalization(Short)<br>for ports 1 and 2 | Short  | Short              |
| <b>Channel 2</b><br>OSM for port 1                                       | -      | Open, Short, Match |

```
[SENSe<Ch>:]CORRection:COLLect:CONNectiON<PhyPt> <ConnectorType>
```

Selects a connector type at a specified port <PhyPt> and its gender.

**Tip:** Use `[SENSe<Ch>:]CORRection:COLLect:SCONNectiOn<PhyPt>` to select an arbitrary connector type using a string variable.

**Suffix:**

<Ch> Channel number of the calibrated channel

<PhyPt> Port numbers of the analyzer

**Note:** If the analyzer is set to use the same connectors at all ports (`[SENSe<Ch>:]CORRection:COLLect:CONNectiOn:PORTsALL`), then a change of a connector type is valid for all ports. The gender of the connectors can still be different.

**Parameters:**

<ConnectorType> N50Female | N50Male | N75Female | N75Male | PC7 | SMAFemale | SMAMale | PC35female | PC35male | PC292female | PC292male | BNC50male | BNC50female | BNC75male | BNC75female | UFEMale1 | UMAle1 | UFEMale2 | UMAle2

Connector type and gender of the connectors (omitted for query). The R&S ZVR-compatible parameters `UFEMALE1` and `UMALE1` denote the user-defined connector type "UserConn1", `UFEMALE2` and `UMALE2` denote the user-defined connector type "UserConn2". `SMAFEMALE` and `SMAMALE` denote the user-defined connector type "SMA". The user-defined connector types must be defined before being addressed by `[SENSe<Ch>:]CORRection:COLLect:CONNectiOn<PhyPt>`.

\*RST: N50FEMALE for all ports.

**Example:**

```
*RST; :CORR:COLL:CONN1 N75MALE; CONN4?
Change the connector type at port 1 from N50FEMALE to N75MALE. The connector type at the other ports is also changed to N75, however, the gender (female) is maintained.
CORR:COLL:CONN4? returns N75FEMALE.
```

**Manual operation:** See "[Connector](#)" on page 135

**[SENSe<Ch>:]CORRection:COLLect:CONNectiOn:GENDErs <Gender>**

Qualifies whether the genders at the test ports (but not their connector types) are equal or independent.

**Suffix:**

<Ch> Channel number of the calibrated channel

**Parameters:**

<Gender> ALL | SINGle  
 ALL – equal (uniform) genders. If the gender at one port is changed, the connector type at all other ports is changed accordingly.  
 SINGle – independent (possibly non-uniform) genders at the ports.  
 \*RST: SINGle

**Example:**

See [SENSe<Ch>:]CORRection:COLLect:CONNectioN:PORTs

**Manual operation:** See "Same Connector / Gender All Ports" on page 265

**[SENSe<Ch>:]CORRection:COLLect:CONNectioN:PORTs <ConnectorType>**

Qualifies whether the connector types at the test ports (but not their gender) are equal or independent. Some calibration types require uniform port connector types.

**Suffix:**

<Ch> Channel number of the calibrated channel

**Parameters:**

<ConnectorType> ALL | SINGle  
 ALL – equal (uniform) connector types. If the connector type at one port is changed, the connector type at all other ports is changed accordingly.  
 SINGle – independent (possibly non-uniform) connector types at the ports.  
 \*RST: ALL

**Example:**

```
CORR:COLL:CONN:PORTS SING
Select independent connector types at the ports.
CORR:COLL:CONN1 N50MALE; CONN4 N75FEMALE;
CONN2?
Select independent connector types at ports 1 and 4. The connector type at port 2 is not changed; the query returns
N50FEMALE.
```

**Manual operation:** See "Same Connector / Gender All Ports" on page 265

**[SENSe<Ch>:]CORRection:COLLect:DELeTe [<CalName>]**

Deletes system error correction data generated and stored previously.

**Suffix:**

<Ch> Channel number of the calibrated channel



**Setting parameters:**

<CalName> Name of the calibration (string parameter) defined together with the calibration type (`[SENSe<Ch>:]CORRection:COLLect:METhod:DEFine`).

ALL - the analyzer deletes all calibrations.

If nothing is specified the analyzer deletes the last system error correction stored by means of `[SENSe<Ch>:]CORRection:COLLect:SAVE:SElected[:DUMMy]`.

\*RST: -

**Example:**

```
CORR:COLL:METh:DEF 'Test',RSHort,1
```

Select a one-port normalization at port 1 with a short standard as calibration type.

```
CORR:COLL:SEL SHOR,1
```

Measure a short standard connected to port 1 and store the measurement results of this standard.

```
CORR:COLL:SAVE:SEL
```

```
CORR:COLL:DEL ALL
```

Calculate the system error correction data and apply it to the active channel, then delete the data.

**Usage:** Setting only

**Manual operation:** See "Apply" on page 267

`[SENSe<Ch>:]CORRection:COLLect:FIXTure[:ACQuire] <StandardType>, <TestPort1>, <TestPort2>...`

Starts a fixture compensation sweep in order to acquire measurement data for a test fixture that has its inner conductor terminated with the selected standards.

**Suffix:**

<Ch> Channel number of the corrected channel

**Setting parameters:**

<StandardType> OPEN | SHORt  
Terminating standard type: open or short.

<TestPort1>

<TestPort2> Test port numbers. For a fixture compensation, n arbitrary (not necessarily consecutive) port numbers must be specified.

\*RST: -

**Example:**

```
*RST; CORR:COLL:FIXT:LMP:LOSS OFF
```

Configure a fixture compensation measurement (for all channels): The analyzer performs an Auto Length (no loss) calculation.

```
CORR:COLL:FIXT:ACQ OPEN, 2; :CORR:COLL:FIXT:ACQ SHOR, 4
```

Perform a fixture compensation sweep at port 2, terminated with an open standard, and at port 4, terminated with a short.

```
CORR:COLL:FIXT:SAVE
```

Save and apply the compensation data.

```
CORR:COLL:FIXT:STAR
```

Prepare a new fixture compensation measurement, deleting the previous data for channel 1.

```
CORR:COLL:FIXT:LMP OFF
```

Select a Direct Compensation measurement (for all channels and traces).

```
CORR:COLL:FIXT:ACQ SHOR, 1, 3
```

Perform a fixture compensation sweep at ports 1 and 3, terminated with a short standard.

```
CALC2:PAR:SDEF 'Trc2', 'S22'
```

Create channel no. 2 with a trace named Trc2.

```
SENS2:CORR:COLL:FIXT:STAR
```

Prepare a fixture compensation measurement for channel 2. The channel 1 data is not affected.

```
SENS2:CORR:COLL:FIXT:ACQ SHOR, 1, 3
```

Repeat the previous fixture compensation sweep for channel 2.

```
SENS1:CORR:COLL:FIXT:SAVE; :SENS2:CORR:COLL:FIXT:SAVE
```

Save and apply the compensation data for both channels.

```
SENS1:CORR:OFFS3:DFC?; :SENS2:CORR:OFFS3:DFC?
```

Query whether the analyzer uses Direct Compensation results at port 3. The response is 1;1 (true for both channels).

**Usage:**

Setting only

**Manual operation:**

See "[Fixture Compensation](#)" on page 314

---

```
[SENSe<Ch>:]CORRection:COLLect:FIXTure:EXPort <FixtureFile>,
<StandardType>, <TestPort1>, <TestPort2>...
```

```
[SENSe<Ch>:]CORRection:COLLect:FIXTure:IMPort <FixtureFile>,
<StandardType>, <TestPort1>[, <TestPort2>...]
```

Loads/saves "Direct Compensation" data from/to the specified file.

The EXPort command first acquires the required data, just as a [SENSe<Ch>:]CORRection:COLLect:FIXTure[:ACQuire] would do.

"Direct Compensation" data files are standard [Trace Files](#), containing reflection parameter traces for the related port(s) and standard.

Table 6-8: Direct Compensation data

| #TestPorts | File Type |
|------------|-----------|
| 1          | s1p       |
| >=1        | csv       |

For 1-port Touchstone files (\*.s1p) only a single test port can be specified - otherwise an error is raised.

**Suffix:**

<Ch> Channel number

**Parameters:**

<FixtureFile> Path to the "Direct Compensation" data file, either absolute or relative to the current directory (set/queried using [MMEMory:CDIRectory](#))

**Setting parameters:**

<StandardType> OPEN | SHORT  
Terminating standard type

<TestPort1>[,  
<TestPort2>, ...] Test port numbers. For a fixture compensation, n different (but not necessarily consecutive) port numbers must be specified.

**Example:**

```
*RST; SENSE1:CORR:COLL:FIXT:LMP OFF
```

Activate "Direct Compensation".

```
SENSE1:CORR:COLL:FIXT:EXP 'Traces\p12_short.csv', SHOR, 1, 2
```

Acquire "Direct Compensation" data for ports 1 and 2 (whose inner connectors have to be terminated with a Short) and save the acquired data to file.

In a subsequent measurement session you can load and apply these data as follows:

```
*RST;
:SENSE1:CORR:COLL:FIXT:LMP OFF
:SENSE1:CORR:COLL:FIXT:IMP 'Traces\p12short.csv', SHOR, 1, 2
:SENSE1:CORR:COLL:FIXT:SAVE
```

**Usage:** Setting only

**Manual operation:** See "[Measure Fixture](#)" on page 315

---

**[SENSe:]CORRection:COLLect:FIXTure:LMPParameter:LOSS[:STATe] <Boolean>**

Selects an Auto Length or an Auto Length and Loss calculation.

**Parameters:**

<Boolean> 1 - Auto Length and Loss  
0 - Auto Length, no loss

```
*RST: 1
```

**Example:** See `[SENSe<Ch>:]CORRection:COLLect:FIXTure[:ACQuire]`

**Manual operation:** See "Fixture Compensation" on page 314

#### **[SENSe:]CORRection:COLLect:FIXTure:LMPParameter[:STATe] <Boolean>**

Selects an Auto Length (and Loss) calculation or a Direct Compensation.

**Parameters:**

<Boolean>            1 - Auto Length (and Loss), depending on the last  
`[SENSe<Ch>:]CORRection:COLLect:FIXTure:LMPParameter:LOSS[:STATe]` setting  
 0 - Direct Compensation  
 \*RST:            1

**Example:** See `[SENSe<Ch>:]CORRection:COLLect:FIXTure[:ACQuire]`

**Manual operation:** See "Fixture Compensation" on page 314

#### **[SENSe<Ch>:]CORRection:COLLect:FIXTure:SAVE**

Completes a fixture compensation, storing and applying the acquired data.

**Suffix:**

<Ch>            Channel number of the corrected channel

**Example:** See `[SENSe<Ch>:]CORRection:COLLect:FIXTure[:ACQuire]`

**Usage:**            Event

**Manual operation:** See "Measure Fixture" on page 315

#### **[SENSe<Ch>:]CORRection:COLLect:FIXTure:START**

Prepares the analyzer for fixture compensation comprising a single or a series of fixture compensation sweeps (`[SENSe<Ch>:]CORRection:COLLect:FIXTure[:ACQuire]`). Previous compensation data is deleted.

**Suffix:**

<Ch>            Channel number of the corrected channel

**Example:** See `[SENSe<Ch>:]CORRection:COLLect:FIXTure[:ACQuire]`

**Usage:**            Event

**Manual operation:** See "Measure Fixture" on page 315

**[SENSe<Ch>:]CORRection:COLLect:LOAD:SELected** <CalGroupFile>, <Standard>, <TestPort1>[, <SecondPortOrAdapter>]

Reloads a set of previously acquired calibration data for a particular standard from a file in the cal pool. The loaded data may be combined with new calibration measurement data (`[SENSe<Ch>:]CORRection:COLLect[:ACQuire]:SELected`) in order to simplify and speed up the new calibration procedure. The channel settings for loaded and new calibrations (e.g. the number of sweep points) must be identical.

**Note:**

- The analyzer performs a consistency check for the loaded data. If the loaded file is incompatible with the channel settings of channel <Ch>, or if it does not contain data for the specified standard and port(s), a command error message (-100, "Command error;...") is generated.
- For a sliding match, the R&S ZNC/ZND can acquire and load measurement data for up to 20 positions per port. Multiple calls of `[SENSe<Ch>:]CORRection:COLLect:LOAD:SELected <CalGroupFile>, SLIDe, <TestPort>` for the same cal group file and test port, implicitly increases the position until position 20 has been recorded. Subsequent calls will start over at position 1, overwriting the previously loaded data.

**Suffix:**

<Ch> Channel number of the calibrated channel

**Parameters:**

<CalGroupFile> String parameter to specify the name of the loaded cal group file.

<Standard> THROugh | OPEN | SHORt | OSHort | OSHort1 | OSHort2 | OSHort3 | MATCh | NET | ATT | REFL | SLIDe | ISOLation | LINE | LIne1 | LIne2 | LIne3 | UTHROugh | POWer  
 Standard types: Through, Open, Short, Match, Symmetric Network (NET), Attenuation (ATT), Reflect, Sliding Match (SLIDe), Line 1 (LINE1 and LINE are synonymous), Line 2 and Line 3 (esp. for TRL calibration), Offset Short 1 to 3 (OShort), Unknown Through.  
 ISOLation is not a physical standard but refers to the isolation terms (optionally) gathered during a transmission normalization or TOSM calibration.

<TestPort1> Test port number. For a transmission standard (through, line, attenuation, symmetric network) or an adapter used as a "through" the input and output port numbers must be specified. For reflection standards, only one port number is required.

**Setting parameters:**

<SecondPortOrAdapter> For a transmission standard or an adapter used as a "through" this parameter specifies the second test port. For reflection measurements with an adapter connected between port and standard, set it to ON. Otherwise set it to OFF or simply omit it.

**Example:** Suppose that the cal pool contains a file 'Calgroup3.cal' with a valid through calibration for the active channel no. 1, which you want to include in a new TOSM calibration for ports 1 and 2.

```
MMEM:CDIR DEF; CDIR 'Calibration\Data'
```

Go to the cal group directory.

```
:SENSe1:CORRection:COLLect:METhod:DEFine 'New Cal', TOSM, 1, 2
```

Define a new TOSM calibration.

```
SENSe1:CORRection:COLLect:LOAD:SELEcted 'Cal Group 3.cal', THROUGH, 1, 2
```

Load the through data from the cal pool file into the new calibration.

```
SENSe1:CORRection:COLLect:ACQuire:SELEcted OPEN, 1
```

Proceed with the new calibration measurements.

**Manual operation:** See ["Ports and Standards"](#) on page 266

---

**[SENSe<Ch>:]CORRection:COLLect:METhod:DEFine** <CalName>, <CalType>, <TestPort1>[, <TestPort2>, <TestPort3orAdapterCalKit>, <TestPorts>...]

Defines the calibration to be performed for channel <Ch>.

If multiple channels shall be calibrated in parallel, use

- [SENSe:]CORRection:COLLect:CHANnels:ALL ON or
- [SENSe:]CORRection:COLLect:CHANnels:MCTypes ON

before executing this command. For background information see [Chapter 3.5.7, "Parallel Calibration of Multiple Channels"](#), on page 102.

Calibration data is acquired using [SENSe<Ch>:]CORRection:COLLect[:ACQuire]:SELEcted.

**Suffix:**

<Ch> Channel number

**Parameters:**

<CalName> Name of the calibration (string parameter). The name serves as a reference to delete a particular set of system correction data ([SENSe<Ch>:]CORRection:COLLect:DELEte).

<CalType> ARTosm | ARPTosm | REFL | RSHort | FOPort | FTRans | RTRans | FRTRans | OPTPort | TOSM | UOSM | TRL | TOM | TSM | TRM | TNA | PTOSm | PTOM | PTSM | PTRM | PTRL | PTNA | PUOSm

Calibration types; see list below.

- <TestPort1> First calibrated test port number. For an n-port calibration type, n port numbers must be specified. If more than n numbers are defined, the spare numbers (the last ones in the list) are ignored. Entering less than n numbers causes an error message. For a one path two port calibration (`OPTPort`), the first port no. denotes the node port (fully calibrated port).
- <TestPort2> Second calibrated port number.
- <TestPort3orAdapterCalFile> the third calibrated port number, or - for Adapter Removal calibrations only - the file path (relative to the current directory) where the analyzer shall store the adapter characterization obtained during the calibration.  
The latter is optional. If a file path is provided the characterization file (in Touchstone s2p format) is generated when the correction terms are finally calculated (`[SENSe<Ch>:]CORRection:COLLect:SAVE:SElected[:DUMMy]`).
- <TestPorts>... More ports to be calibrated.

**Example:**

```
:SENSE1:CORRECTION:COLLECT:METHOD:
DEFine 'Test', ARTosm, 1,2, 'Adapter.s2p'
Initiate an Adapter Removal calibration for ports 1 and 2 on
channel 1 and store the adapter characterization in
<MEMORY:CDIR?>\Adapter.s2p.
For another example see [SENSe<Ch>:]CORRection:
COLLect:SAVE:SElected[:DUMMy].
```

**Manual operation:** See "[Type / Source](#)" on page 263

The supported calibration types are listed below.

**Note:** For a unidirectional R&S ZND (see [Chapter 3.1.4.2, "R&S ZND: Unidirectional vs. Bidirectional Operation"](#), on page 16) "bidirectional calibrations" are not available.

| Parameter                                                  | Type ("Calibration Presetting" dialog)                                                                                                                                   |
|------------------------------------------------------------|--------------------------------------------------------------------------------------------------------------------------------------------------------------------------|
| ARTosm                                                     | Adapter Removal                                                                                                                                                          |
| REFL   RSHort                                              | Refl Norm Open   Refl Norm Short                                                                                                                                         |
| FOPort                                                     | Full One Port ("Refl OSM")                                                                                                                                               |
| FTRans   RTRans   FRTRans                                  | Trans Norm - Forward   Trans Norm - Reverse   Trans Norm Both<br>"Forward" ("Reverse") means that the port with the smaller (larger) port number serves as a drive port. |
| OPTPort                                                    | One Path Two Ports                                                                                                                                                       |
| TOSM                                                       | TOSM                                                                                                                                                                     |
| UOSM                                                       | UOSM                                                                                                                                                                     |
| TRL   TOM   TSM   TRM   TNA                                | TRL   TOM   TSM   TRM   TNA                                                                                                                                              |
| ARPTosm   PTOSm   PUOSm   PTRL   PTOM   PTSM   PTRM   PTNA | One of the previous calibration types in combination with a power calibration (for SMARTerCal).                                                                          |

**[SENSe:]CORRection:COLLect:PMETer:ID <PowerMeter>, <TestPort>**

Selects an external power meter for the SMARTerCal and assigns it to an analyzer port.

**Note:** The command cannot be used unless a power meter is connected via GPIB bus, USB or LAN interface and configured in the "External Power Meters" dialog.

**Parameters:**

|                           |                                                                                                                                                                                                                                             |
|---------------------------|---------------------------------------------------------------------------------------------------------------------------------------------------------------------------------------------------------------------------------------------|
| <b>&lt;PowerMeter&gt;</b> | Number of external power meter. The parameters UP, DOWN, MIN, MAX are not available for this command.<br>Range: 1 to number of configured external generators<br>*RST: The power meter selection is not changed by a reset of the analyzer. |
| <b>&lt;TestPort&gt;</b>   | Test port number. During power calibration, the power meter is connected to this port.<br>*RST: 1 to the number of test ports                                                                                                               |

**Example:** See `[SENSe<Ch>:]CORRection:COLLect:AUTO:POWer`

**[SENSe<Ch>:]CORRection:COLLect:SAVE:SELEcted:DEFault**

Generates a set of default system error correction data for the selected ports and calibration type. The default data set corresponds to a test setup which does not introduce any systematic errors; none of the measurement results acquired previously (`[SENSe<Ch>:]CORRection:COLLect[:ACQuire]:SELEcted`) is taken into account.

**Tip:** The main purpose of the default correction data set is to provide a dummy system error correction which you can replace with your own, external correction data. You may have acquired the external data in a previous session or even on an other instrument. If you want to use the external correction data on the analyzer, simply generate the default data set corresponding to your port configuration and calibration type and overwrite the default data. For details refer to the program example below.

**Suffix:**

|                   |                                           |
|-------------------|-------------------------------------------|
| <b>&lt;Ch&gt;</b> | Channel number of the calibrated channel. |
|-------------------|-------------------------------------------|



**Example:**

```
CORR:COLL:METH:DEF 'Test',RShort,1
```

Select a one-port normalization at port 1 with a short standard as calibration type.

```
CORR:COLL:SAVE:SEL:DEF
```

Calculate a dummy system error correction for the normalization at port 1. The dummy system error correction provides the reflection tracking error term 'REFLTRACK'.

```
CORR:CDAT? 'REFLTRACK',1,0
```

Query the dummy system error correction term. The response is a 1 (written as 1,0 for the real and imaginary part) for each sweep point (no attenuation and no phase shift between the analyzer and the calibration plane).

```
INIT:CONT OFF; :INIT; *WAI
```

Stop the sweep to ensure correct transfer of calibration data.

```
CORR:CDAT 'REFLTRACK',1,0,<ASCII_data>
```

Replace the dummy system error correction term with your own correction data, transferred in ASCII format.

```
INIT:CONT ON
```

Restart the sweep in continuous mode.

**Usage:** Event

**Manual operation:** See "Apply" on page 267

### [SENSe<Ch>:]CORRection:COLLect:SAVE:SELected[:DUMMy]

Calculates the system error correction data from the acquired measurement results ([SENSe<Ch>:]CORRection:COLLect[:ACQuire]:SELected), stores it and applies it to the calibrated channel(s). To avoid incompatibilities, older system error correction data is deleted unless it has been transferred into a cal pool (MMEMory:STORe:CORRection<Ch>, '<file\_name>').

**Suffix:**

<Ch> One of the calibrated channels  
 If [SENSe:]CORRection:COLLect:CHANnels:ALL is ON this suffix can be omitted

**Example:**

```
CORRection:COLLect:METHod:DEFine 'Test',RShort,1
```

Select a one-port normalization at port 1 with a short standard as calibration type.

```
CORRection:COLLect:CHANnels:ALL ON
```

Enable calibration in all channels of the active recall set.

```
CORRection:COLLect:SELected SHOR,1
```

Measure a short standard connected to port 1 and store the measurement results of this standard.

```
CORRection:COLLect:SAVE:SELected
```

Calculate the system error correction data and apply it to all channels of the active recall set.

**Usage:** Event

**Manual operation:** See "Apply" on page 267

---

**[SENSe<Ch>:]CORRection:COLLect:SCONnection<PhyPt> <Type>[, <Gender>]**

Selects a connector type at a specified port <PhyPt> and its gender. In contrast to [\[SENSe<Ch>:\]CORRection:COLLect:CONNECTION<PhyPt>](#), this command uses a string variable to identify the connector type.

**Suffix:**

<Ch> Channel number of the calibrated channel

<PhyPt> Port numbers of the analyzer. If the analyzer is set to use the same connectors at all ports ([\[SENSe<Ch>:\]CORRection:COLLect:CONNECTION:PORTsALL](#)), then a change of a connector type is valid for all ports. The gender of the connectors can still be different.

**Parameters:**

<Type> Connector type (string parameter) of the connectors. See "Cal kit naming conventions" under [\[SENSe:\]CORRection:CKIT:<ConnType>:SElect](#).

\*RST: 'N 50 Ohm',FEM for all ports.

<Gender> MALE | FEMale

Gender of the connectors. The gender designation is not necessary (and ignored) for sexless connector types.

**Example:** \*RST; :CORR:COLL:SCON1 'N 75 Ohm', MALE; SCON4?

Change the connector type at port 1 from 'N 50 Ohm', FEM to 'N 75 Ohm', MALE. The connector type at the other ports is also changed to N 75 Ohm, however, the gender (female) is maintained. [CORR:COLL:SCON4?](#) returns 'N 75 Ohm', FEM.

**Manual operation:** See "[Connector / Gender](#)" on page 264

---

**[SENSe<Ch>:]CORRection:CONNECTION <ConnectorName>[, <Mode>, <Gender>, <RelPermittivity>, <RefImpedance>]**

Configures the user-defined connector types.

**Suffix:**

<Ch> Channel number

**Parameters:**

<ConnectorName> Name of the user-defined connectors, string parameter.

<Mode> TEM | WGUide

Transverse electric or waveguide type propagation mode.

<Gender> GENDER | NGENER

GENDER – polar connector type (m/f)

NGENDER – sexless connector type

|                   |                                                                                                                                                                                                                                                                                         |
|-------------------|-----------------------------------------------------------------------------------------------------------------------------------------------------------------------------------------------------------------------------------------------------------------------------------------|
| <RelPermittivity> | Relative permittivity<br>Range: 0.0000000001 to 1000.                                                                                                                                                                                                                                   |
| <RefImpedance>    | For TEM type connectors: reference impedance in $\Omega$ (without unit), For waveguide ( <i>wG<sub>uide</sub></i> ) type connectors: cutoff frequency in Hz (without unit).<br>Range: Ref. impedance: 1 $\mu\Omega$ to 1000 M $\Omega$ . Cutoff frequency: 0 Hz to 1000 GHz.<br>*RST: - |

**Example:**

```

CORR:CONN 'USERCON', TEM, GEND, 1.00000, 50
Define a TEM type connector type named USERCON.
CORR:CONN? 'USERCON'
Query the properties of the configured connector type.
CORR:CONN:DEL 'USERCON'
Delete the configured connector type.

```

**Manual operation:** See "[Connector / Gender](#)" on page 264

---

#### [SENSe<Ch>:]CORRection:CONNection:CATalog?

Returns a list of the connector types of all calibration kits in use.

**Suffix:**

<Ch> Channel number. This suffix is ignored because connector types are channel-independent.

**Example:** CORRection:CONNection:CATALog?  
 Query connector types. Possible response: 'N 50 Ohm,N 75 Ohm,7 mm,3.5 mm,2.92 mm,2.4 mm,1.85 mm,7-16,Type F (75) '  
 CORRection:CKIT:CATALog? 'N 50 Ohm'  
 Query cal kits for N (50 Ω) connector types. Possible response: 'N 50 Ohm Ideal Kit,3653,85054D,ZV-Z121,ZCAN 50 Ohm,ZV-Z21 typical,85032B/E,85032F,85054B,New Kit 1'. We assume that a cal kit New Kit 1 with label 2012-05-25 was created before.  
 CORRection:CKIT:LCATALog? 'N 50 Ohm'  
 Query cal kits for N (50 Ω) connector types with their labels. Possible response: 'N 50 Ohm Ideal Kit,,3653,,85054D,,ZV-Z121,,ZCAN 50 Ohm,,ZV-Z21 typical,,85032B/E,,85032F,,85054B,,New Kit 1,2012-05-25'. A sequence of two commas means that the preceding cal kit has no label assigned.  
 CORRection:CKIT:STANdard:CATALog? '85032B/E'  
 Query standards in cal kit named 85032B/E. Possible response: 'MOP,FOP,MSH,FSH,MMMT,FMMT,MFTH'  
 CORRection:CKIT:STANdard:LCATALog? 'New Kit 1','2012-05-25'  
 Query standards in user cal kit named New Kit 1 labelled 2012-05-25. Possible response: 'MOP,FOP,MSH(P1),FSH,MMMT,FMMT,MSM,FSM,MREF,FREF,MOSHORT2,FOSHORT2,MOSHORT3,FOSHORT3,MMTH,MMTH(P2P3)...' (P1 etc. denote restricted port assignments).

**Usage:** Query only

**Manual operation:** See "[Connector / Gender](#)" on page 264

---

**[SENSe<Ch>:]CORRection:CONNection:DELeTe <ConnectorName>**

Deletes a user-defined connector type named <ConnectorName>.

**Suffix:**

<Ch> Channel number

**Setting parameters:**

<ConnectorName> Name of the user-defined connectors, string parameter.

**Example:** See [\[SENSe<Ch>:\]CORRection:CONNection](#)

**Usage:** Setting only

**Manual operation:** See "[Connector / Gender](#)" on page 264

---

**[SENSe<Ch>:]CORRection:DATA:PARAMeter<Sfk>? <SfkSettingType>[, <Index>]**

Gets the settings of the active system error correction (or of the factory calibration, if no channel calibration is active).

**Suffix:**

&lt;Ch&gt;

Number of the calibrated channel.

&lt;Sfk&gt;

Number of the system error correction.  
Must be omitted or set to 1.

**Query parameters:**

<SfkSettingType> ACAL | START | STOP | POINTs | SPOWer | STYPE | BANDwidth | PDLY | RATTenuation | TYPE | PORTs | SPORT | THROughs | TSTamp | LTSTamp | TVNA | MVNA | MTEST | CKIT | FSMode

The requested setting.

If no <SfkSettingType> is specified, the values for START, STOP, POINTs, SPOWer and STYPE are returned

**ACAL**

1 for automatic calibrations, 0 for manual calibrations

**START**

Start frequency (or CW frequency, if no frequency sweep is active)

**STOP**

Stop frequency (or CW frequency, if no frequency sweep is active)

**POINTs**

Number of points

**SPOWer**

Source power (or stop power, for power sweeps)

**STYPE**

Sweep type or grid (LIN, LOG, SEGM)

**BANDwidth**

Measurement bandwidth

**PDLY**

Point delay (Meas Delay) for OSM

**RATTenuation**

Receiver attenuations: comma-separated list containing a value pair <port no.>,<rec. att.> (float,integer) for each of the involved

**PORTs****TYPE**

Calibration type (see <Type> parameter in [\[SENSE<Ch>: \]CORRection:COLLect\[:ACQuire\]:SELected](#) on page 601)

**PORTs**

The related test port numbers (comma-separated list of integers)

**THROughs**

Measured Throughs: comma-separated list of directed port number pairs <pno1-pno2>

**TSTamp**

Timestamp in UTC

**LTSTamp**

Timestamp in local time

**CKIT**

If created with FW version 2.30 or higher, for each port the name of the used calibration kit is stored with a calibration.

The query can return one of the following:

**the cal kit name** (string)

if available and unique

**'Multiple'**

if cal kit names are available but not unique, i.e. if <PhyPt> was not specified and multiple cal kits were used (multi-port calcs with different connector types, merged calcs)

**'Unknown'**

if cal kit names are not available (calcs created with a FW version < 2.30)

<Index>

Not used

**Example:**

SENSe:CORRection:DATA:PARAmeter?

Unrestricted query. Result looks like this:

100000,8500000000,201,-10,LIN

SENSe:CORRection:DATA:PARAmeter? START

...

SENSe:CORRection:DATA:PARAmeter? STYPE

Query settings one by one.

SENSe:CORRection:DATA:PARAmeter? RATTenuation

Query receiver attenuations. Result looks like this:

1,0.000000,2,0.000000

**Usage:**

Query only

**Manual operation:** See "Apply" on page 267

#### [SENSe<Ch>:]CORRection:DATA:PARAmeter:COUNT?

Gets the number of active system error corrections for channel <Ch>.

This may be > 1 in case the enhanced multi-calibration wizard was used (see [SYSTEM:DISPlay:DIALogs:SETup:MCAL\[:STATe\]](#) on page 734) to collect the calibration data. The properties of the available calibrations can be queried using the [\[SENSe<Ch>:\]CORRection:DATA:PARAmeter<Sfk>?](#) command.

**Suffix:**

<Ch>

Channel number of the calibrated channel.

**Usage:**

Query only

#### [SENSe<Ch>:]CORRection:DATE?

Returns the date and time when the active system error correction data for channel <Ch> was acquired (see example).

**Suffix:**

<Ch>

Channel number of the calibrated channel

**Example:**

```
CORR:COLL:METH REFL1
Select a one-port normalization at port 1 as calibration type.
CORR:COLL:OPEN1
Measure an open standard connected to port 1 and store the
measurement results of this standard.
CORR:COLL:SAVE
Calculate the system error correction data and apply it to the
active channel.
CORR:DATE?
Query the time when the system error correction became active.
The analyzer returns the date and time, e.g.
'03/20/11,18:30:39'.
CORR:DATA:PAR?
Query the sweep settings for the calibration sweep. The ana-
lyzer returns the start and stop frequency, the number of points,
source power, and the sweep type, e.g.
300000,8000000000,201,0,LIN.
CORR:SST?
Query the calibration status. The analyzer returns 'CAL OFF'
(because the performed one-port calibration is not sufficient for
the measured transmission S-parameter S21).
```

**Usage:** Query only

**Manual operation:** See ["Apply"](#) on page 267

---

#### [SENSe<Ch>:]CORRection:EDELay<PhyPt>:AUTO <Activate>

Defines the offset parameter for the active test port such that the residual delay of the active trace (defined as the negative derivative of the phase response) is minimized across the entire sweep range ("Auto Length").

**Suffix:**

<Ch> Channel number of the offset-corrected channel

<PhyPt> Port number of the analyzer. This numeric suffix is ignored; the active port is determined by the active trace.

**Setting parameters:**

<Activate> ONCE

Applies the auto length function.

**Example:** \*RST; :CORR:EDEL:AUTO ONCE

Reset the instrument and apply the auto length function to the default trace (Trc1 in channel 1).

**Usage:** Setting only

**Manual operation:** See ["Auto Length"](#) on page 314



**[SENSe<Ch>:]CORRection:EDELay<PhyPt>:DIElectric <Permittivity>**

Defines the permittivity for the offset correction at test port <PhyPt>.

**Suffix:**

<Ch> Channel number of the offset-corrected channel  
 <PhyPt> Port number of the analyzer

**Parameters:**

<Permittivity> Permittivity  
 Range: 1 to +1E+6  
 \*RST: 1.00062

**Example:** See [\[SENSe<Ch>:\]CORRection:EDELay<PhyPt>:ELENgth](#)

**Manual operation:** See "[Permittivity / Velocity Factor](#)" on page 313

**[SENSe<Ch>:]CORRection:EDELay<PhyPt>:DISTance <MechLength>**

Defines the offset parameter for test port <PhyPt> as a mechanical length.

**Suffix:**

<Ch> Channel number of the offset-corrected channel  
 <PhyPt> Port number of the analyzer

**Parameters:**

<MechLength> Mechanical length  
 Range: -3.402823466E+038 m to +3.4028234664E+038 m.  
 \*RST: 0 m  
 Default unit: m

**Example:** See [\[SENSe<Ch>:\]CORRection:EDELay<PhyPt>:ELENgth](#)

**Manual operation:** See "[Delay / Electrical Length / Mechanical Length](#)" on page 312

**[SENSe<Ch>:]CORRection:EDELay<PhyPt>:ELENgth <ElecLength>**

Defines the offset parameter for test port <PhyPt> as an electrical length.

**Suffix:**

<Ch> Channel number of the offset-corrected channel  
 <PhyPt> Port number of the analyzer

**Parameters:**

<ElecLength> Electrical length  
 Range: -1E+9 m to +1E+9 m.  
 Increment: 1 mm  
 \*RST: 0 m  
 Default unit: m

**Example:**

```
CORR:EDEL2:ELEN 0.3
```

Define an electrical length of 30 cm for channel 1 and port no. 2.

```
CORR:EDEL2:DIST?; DIEL?
```

Query the values of the mechanical length and the permittivity at port 2. The mechanical length is equal to the electrical length divided by the square root of the permittivity; the latter is set to its default value. The response is 0.29990704322;1.00062.

```
CORR:EDEL2?
```

Query the value of the delay at port 2. The delay is equal to the electrical length divided by the speed of light in the vacuum, so the response is 1.0006922856E-009.

```
CORR:LOSS2 2; LOSS2:FREQ 1.5 GHz; OFFS 3 dB
```

Define the offset loss parameters at port 2.

**Manual operation:** See "[Delay / Electrical Length / Mechanical Length](#)" on page 312

**[SENSe<Ch>:]CORRection:EDELay<PhyPt>[:TIME] <Delay>**

Defines the offset parameter for test port <PhyPt> as a delay time.

**Suffix:**

<Ch> Channel number of the offset-corrected channel

<PhyPt> Port number of the analyzer

**Parameters:**

<Delay> Delay  
 Range: -3.40282346638529E+038 s to  
 +3.40282346638529E+038 s.  
 \*RST: 0 s  
 Default unit: s

**Example:** See `[SENSe<Ch>:]CORRection:EDELay<PhyPt>:ELENgth`

**Manual operation:** See "[Delay / Electrical Length / Mechanical Length](#)" on page 312

**[SENSe<Ch>:]CORRection:LOSS<PhyPt> <OffsetLoss>**

Defines the offset loss at the reference frequency (`[SENSe<Ch>:]CORRection:LOSS<PhyPt>:FREQuency`).

**Suffix:**

<Ch> Channel number of the offset-corrected channel

<PhyPt> Port number of the analyzer

**Parameters:**

<OffsetLoss> Frequency-dependent part of the offset loss  
 Range: -200 dB to +200 dB  
 Increment: 0.001 dB  
 \*RST: 0 dB  
 Default unit: dB

**Example:** See `[SENSe<Ch>:]CORRection:EDELay<PhyPt>:ELENgth`

**Manual operation:** See "Loss at DC / Loss at Freq / Freq for Loss" on page 318

### `[SENSe<Ch>:]CORRection:LOSS<PhyPt>:AUTO <Activate>`

Defines the offset parameters for the active test port such that the residual delay of the active trace (defined as the negative derivative of the phase response) is minimized and the measured loss is reproduced as far as possible across the entire sweep range ("Auto Length and Loss").

**Suffix:**

<Ch> Channel number of the offset-corrected channel

<PhyPt> Port number of the analyzer. This numeric suffix is ignored; the active port is determined by the active trace.

**Setting parameters:**

<Activate> ONCE

Applies the "Auto Length and Loss" function.

**Example:**

`*RST; :CORR:LOSS:AUTO ONCE`

Reset the instrument and apply the "Auto Length and Loss" function to the default trace (Trc1 in channel 1).

**Usage:** Setting only

**Manual operation:** See "Auto Length and Loss" on page 319

### `[SENSe<Ch>:]CORRection:LOSS<PhyPt>:FREQuency <RefFreq>`

Defines the reference frequency for the frequency-dependent part of the offset loss (`[SENSe<Ch>:]CORRection:LOSS<PhyPt>:OFFSet`).

**Suffix:**

<Ch> Channel number of the offset-corrected channel

<PhyPt> Port number of the analyzer

**Parameters:**

<RefFreq> Reference frequency

Range: Frequency range of the analyzer model.

Increment: 1 MHz

\*RST: 1000000000 Hz (= 1 GHz)

Default unit: Hz

**Example:** See `[SENSe<Ch>:]CORRection:EDELay<PhyPt>:ELENgth`

**Manual operation:** See "Loss at DC / Loss at Freq / Freq for Loss" on page 318

### `[SENSe<Ch>:]CORRection:LOSS<PhyPt>:OFFSet <OffsetLoss>`

Defines the frequency-independent part (DC value) of the offset loss.

**Suffix:**

<Ch> Channel number of the offset-corrected channel

<PhyPt> Port number of the analyzer

**Parameters:**

<OffsetLoss> Frequency-independent part of the offset loss

Range: -200 dB to +200 dB

Increment: 0.001 dB

\*RST: 0 dB

Default unit: dB

**Example:** See [\[SENSe<Ch>:\]CORRection:EDELay<PhyPt>:ELENgth](#)

**Manual operation:** See "[Loss at DC / Loss at Freq / Freq for Loss](#)" on page 318

**[SENSe<Ch>:]CORRection:OFFSet<PhyPt>[:STATe] <Boolean>**

Resets the offset parameters for all test ports to zero and the reference frequency to 1 GHz or queries whether any of the offset parameters are different from zero.

**Suffix:**

<Ch> Channel number of the offset-corrected channel

<PhyPt> Port number of the analyzer. This numeric suffix is ignored; the command affects the parameters of all ports.

**Parameters:**

<Boolean> The parameter function depends on whether the command is used as a setting command or as a query: For setting command:  
ON - no effect

OFF - resets all length offsets to zero and the reference frequency to 1 GHz

For query:

1 - at least one length offset parameter is different from its default value

0 - all length offsets are zero / set to default

\*RST: OFF

**Example:** \*RST; :CORR:OFFS?

Reset the instrument and query whether the length offset parameters have been reset as well. The response is 0.

**Manual operation:** See "[Offset](#)" on page 310

**[SENSe<Ch>:]CORRection:OFFSet<PhyPt>:COMPensation[:STATe] <Boolean>**

Toggles length/loss/fixture compensation for physical port <PhyPt> ON/OFF.

**Suffix:**

<Ch> Channel number

<PhyPt> Physical port number

**Parameters:**

<Boolean>                    ON (1): compensation active  
                                   OFF (0): compensation inactive

**Manual operation:**    See ["Offset"](#) on page 310

**[SENSe<Ch>:]CORRection:OFFSet<PhyPt>:DFComp[:STATe]?**

Returns whether a direct fixture compensation has been carried out at port no. <PhyPt>. A direct fixture compensation resets the offset parameters to zero, the analyzer uses calculated transmission factors instead.

**Suffix:**

<Ch>                            Channel number of the offset-corrected channel  
 <PhyPt>                        Port number of the analyzer.

**Return values:**

<Boolean>                    1 - direct fixture compensation data used  
                                   0 - no direct fixture compensation data used

**Example:**

```
*RST; CORR:OFFS:DFC?
```

Reset the instrument and query whether the analyzer uses direct fixture compensation data at port 1. The response is 0.

**Usage:**                      Query only

**Manual operation:**    See ["Fixture Compensation"](#) on page 314

**[SENSe<Ch>:]CORRection:POWer<PhyPt>:ACQuire <Wave>[, <CalPort>, <SourceType>, <SourcePort>]**

Selects the wave quantity and the source for the receiver power calibration, starts the calibration sweep, and applies the receiver power correction.

**Suffix:**

<Ch>                            Calibrated channel number  
 <PhyPt>                        Calibrated port number. This suffix is ignored because the port number is specified in the parameter list.

**Setting parameters:**

|                           |                                                                                                                                                                                                                                                                                                                                                                                                                                                                                                                                                                                                                                                                                                                           |
|---------------------------|---------------------------------------------------------------------------------------------------------------------------------------------------------------------------------------------------------------------------------------------------------------------------------------------------------------------------------------------------------------------------------------------------------------------------------------------------------------------------------------------------------------------------------------------------------------------------------------------------------------------------------------------------------------------------------------------------------------------------|
| <b>&lt;Wave&gt;</b>       | AWAVe   BWAVe   B1   B2   B3   B4<br>AWAVe – calibration of reference waves $a_1, a_2, \dots$ . In manual control, the reference receiver calibration is included in the source power calibration of each port.<br>BWAVe – calibration of received wave $b_1, b_2, \dots$ . The port number <code>&lt;CalPort&gt;</code> , the used <code>&lt;SourceType&gt;</code> , and the <code>&lt;SourcePort&gt;</code> number must be specified in addition.<br>Alternative: Parameters B1 and B2.<br>B1   B2 ... – direct wave and cal port setting for received waves $b_1, b_2 \dots$ . The parameters B1 and B2 are ZVR-compatible. No additional parameters need to be specified. The source for B1 is Port 2 and vice versa. |
| <b>&lt;CalPort&gt;</b>    | Calibrated port number<br>Range: 1 to port number of the analyzer                                                                                                                                                                                                                                                                                                                                                                                                                                                                                                                                                                                                                                                         |
| <b>&lt;SourceType&gt;</b> | PORT   GENerator<br>PORT - internal source at port <code>&lt;CalPort&gt;</code> , to be fed to port <code>&lt;SourcePort&gt;</code> using an external through connection. If <code>&lt;CalPort&gt; = &lt;SourcePort&gt;</code> , an Open or Short standard is required.<br>GENerator - not supported.                                                                                                                                                                                                                                                                                                                                                                                                                     |
| <b>&lt;SourcePort&gt;</b> | Number of the port for the internal source or generator.<br>Range: 1 to port number of the analyzer/number of external generators.                                                                                                                                                                                                                                                                                                                                                                                                                                                                                                                                                                                        |

**Example:**

```
*RST; CORR:POW:ACQ AWAVe,1,PORT,1
```

Perform a receiver power calibration of the wave  $a_1$  using port 1 as a source port, assuming that the transmitted source power  $a_1$  is correct. No external cabling is needed.

```
CORR:POW:AWAV?
```

Check whether the calibration is applied (the response is 1).

```
CALC:PAR:MEAS 'TRC1', 'A1'
```

Select  $a_1$  as a measured quantity for the default trace.

```
CALC:MARK ON; MARK:Y?; :SOUR:POW?
```

Create marker no. `<Mk>` in the center of the sweep range and query the measurement value. The calibrated power of the reference wave  $a_1$  is approx. equal to the default source power value. See also example for [\[SENSe<Ch>:\]CORRection:OFFSet<PhyPt>\[:STATe\]](#).

**Usage:** Setting only

**Manual operation:** See "[Port Overview](#)" on page 269

---

**[SENSe<Ch>:]CORRection:PCAL <ActivatePowerCals>**

Activates or deactivates all power calibrations.

**Suffix:**

<Ch>                      Calibrated channel number

**Setting parameters:**

<ActivatePowerCals> NONE | ALL

NONE – deactivate all power calibrations.

ALL – activate all power calibrations.

\*RST:            n/a

**Example:**

\*RST; CORR:POW:ACQ AWAVe, 1, PORT, 1

Perform a receiver power calibration of the wave  $a_1$  using port 1 as a source port, assuming that the transmitted source power  $a_1$  is correct. No external cabling is needed.

CORR:POW:AWAV?

Check whether the calibration is applied (the response is 1).

CORR:PCAL NONE; POW:AWAV?

Disable all power calibrations and check again whether the calibration is applied (the response is 0).

**Usage:**

Setting only

**Manual operation:** See "All Power Cals On / Off" on page 293

**[SENSe<Ch>:]CORRection:POWer<PhyPt>:AWAVe[:STATe] <Boolean>**

Enables or disables the receiver power calibration for channel <Ch> and for the reference waves  $a_n$ . The setting command is disabled unless the reference waves have been power calibrated (`[SENSe<Ch>:]CORRection:POWer<PhyPt>:ACQuire` on page 637 `AWAVe, . . .`). The query always returns a result.

This command extends the functionality of manual control, where the reference receiver calibration is included in the source power calibration of each port (and always ON).

**Suffix:**

<Ch>                      Calibrated channel number

<PhyPt>                  Calibrated port number

**Parameters:**

<Boolean>                Enables (ON) or disables (OFF) the receiver power calibration for the reference waves  $a_n$ .

\*RST:            OFF

**Example:**              See `[SENSe<Ch>:]CORRection:POWer<PhyPt>:ACQuire`

**[SENSe<Ch>:]CORRection:POWer:DATA <Wave>, <CorrData>...**

Reads or writes receiver power correction data sets. A power correction data set contains  $n$  real values where:

- Each value corresponds to the ratio of the actual power at the receiver input (value provided by the used source) to the uncalibrated power in dB.

- The number *n* is equal to the number of sweep points.

Increasing (decreasing) the values in the correction data sets increases (decreases) the input power reading. Writing correction data (the setting command) fails if the number of transferred values is not equal to the number of sweep points.

**Suffix:**

<Ch>                      Calibrated channel number

**Parameters:**

<Wave>                    Identifier for the calibrated wave:  
 'A<n>' or 'AWAV<n>' denote correction data for the reference wave *a*<*n*>, where <*n*> corresponds to the port number.  
 'B<n>' or 'BWAV<n>' denote correction data for the reference wave *b*<*n*>.

<CorrData>                Power correction values either in ASCII or block data format, depending on the current `FORMat [:DATA]` setting.

**Example:**

```
*RST; :SWE:POIN 10
```

Reset the instrument and reduce the number of sweep points to 10.

```
CORR:POW:ACQ AWAVE,1,PORT,1
```

Perform a receiver power calibration of the wave *a*<sub>1</sub> using port 1 as a source port, assuming that the transmitted source power *a*<sub>1</sub> is correct. No external cabling is needed.

```
CORR:POW:DATA? 'AWAV1'
```

Query the correction values. The analyzer returns 10 comma-separated real numbers.

```
CORR:POW:DATA 'AWAV1', 1, 2, 3, 4, 5, -6, -7, -8, -9, -0
```

Replace the correction values by ten (new) numbers.

**Manual operation:** See "[Start Cal Sweep](#)" on page 273

**[SENSe<Ch>:]CORRection:POWer<PhyPt>[:STATe]** <Boolean>

Enables or disables the receiver power calibration for channel <Ch> and for the received waves *b*<PhyPt>. The setting command is disabled unless the received waves have been power calibrated (`[SENSe<Ch>:]CORRection:POWer<PhyPt>:ACQuireBWAVE, ...`). The query always returns a result.

**Suffix:**

<Ch>                      Calibrated channel number

<PhyPt>                    Calibrated port number

**Parameters:**

<Boolean>                Enables (ON) or disables (OFF) the receiver power calibration for the received waves *b*<PhyPt>.

```
*RST:            OFF
```



**Example:** `*RST; CORR:POW:ACQ BWAVE,1,PORT,2`  
 Perform a receiver power calibration of the wave b1 using port 2 as a source port, assuming that the source power a<sub>2</sub> is correct. A through connection from port 2 to port 1 is needed.  
`CORR:POW?`  
 Check whether the calibration is applied (the response is 1).  
`CALC:PAR:MEAS 'TRC1', 'B1D2'`  
 Select b<sub>1</sub> as a measured quantity for the default trace.  
`CALC:MARK ON; MARK:Y?; :SOUR:POW?`  
 Create marker no. <Mk> in the center of the sweep range and query the measurement value. The calibrated power of the received wave b<sub>1</sub> is approx. equal to the default source power value.  
 See also example for [\[SENSe<Ch>:\]CORRection:POWeR<PhyPt>:ACQuire](#).

**Manual operation:** See ["Port Overview"](#) on page 293

#### **[SENSe<Chn>:]CORRection:SState?**

Returns the system error correction state label of the active trace in channel <Chn>. The response is a string variable containing the calibration state label in the trace list ('Cal', 'Cai', 'Cal Off' ...; see [Chapter 3.5.4, "Calibration Labels"](#), on page 91).

**Suffix:**  
 <Chn> Channel number used to identify the active trace.

**Example:** See [\[SENSe<Ch>:\]CORRection:DATE?](#)

**Usage:** Query only

**Manual operation:** See ["Apply"](#) on page 267

#### **[SENSe<Ch>:]CORRection[:State] <Boolean>**

Enables or disables the system error correction for channel <Ch>.

**Suffix:**  
 <Ch> Calibrated channel number

**Parameters:**  
 <Boolean> Enables (ON) or disables (OFF) the correction.  
`*RST: ON`

**Example:** `*RST; :CORR?`  
 Reset the instrument and query whether channel 1 is system error corrected. The response is 1.

**Manual operation:** See ["User Cal Active"](#) on page 292

**[SENSe<Ch>:]CORRection:STIMulus?**

Queries the stimulus values of the active calibration. A calibration must be selected before the command is executed; see example.

**Suffix:**

<Ch> Channel number of the calibrated channel

**Example:**

```
*RST; :CORR:COLL:METH:DEF 'Test',RShort,1
```

Select a one-port normalization at port 1 with a short standard as calibration type.

```
CORR:STIM?
```

Query the stimulus frequencies. The response contains 201 frequency values.

```
CORR:COLL:SEL SHOR,1
```

Measure a short standard connected to port 1 and store the measurement results of this standard.

```
CORR:COLL:SAVE:SEL
```

Calculate the system error correction data and apply it to the active channel.

**Usage:** Query only

**Manual operation:** See ["Apply"](#) on page 267

**[SENSe<Chn>:]CORRection:PSTate?**

Gets the power calibration label of the active trace in channel <Chn>.

See [Chapter 3.5.6.3, "Power Calibration Labels"](#), on page 100 for the possible return values.

**Suffix:**

<Chn> Channel number used to identify the active trace.

**Usage:** Query only

**Manual operation:** See ["Apply"](#) on page 270

**6.3.15.7 [SENSe:]COUPle...**

The [SENSe:]COUPle... commands select the sweep mode.

**[SENSe<Ch>:]COUPle <Order>**

Determines the order of partial measurements and sweeps.

**Suffix:**

<Ch> Channel number. This suffix is ignored; the sweep mode applies to all channels in the active recall set.

**Parameters:**

<Order> ALL | AUTO | NONE  
 AUTO - optimized display update: fast sweeps are performed in alternated mode, slower sweeps in chopped mode  
 ALL - chopped sweep mode, complete all partial measurements before proceeding to the next sweep point  
 NONE - alternated sweep mode on, reverse the order of partial measurements and sweeps  
 \*RST: NONE

**Example:**

```
COUP NONE
Activate the alternated sweep mode.
TRIG:LINK 'PPO'
Set the triggered measurement sequence equal to one partial measurement. Each trigger event starts one partial measurement for all sweep points.
```

**Manual operation:** See "Driving Mode" on page 300

**6.3.15.8 [SENSe:]FREQUENCY...**

The [SENSe:]... commands set frequency-related parameters, especially the measurement and display ranges for the different sweep types. The frequency ranges for the different instrument models are listed below; for more details refer to the data sheet.

*Table 6-9: Frequency ranges of R&S ZNC/ZND analyzers*

| Frequency settings | R&S ZNC3             | R&S ZND (with frequency range extension) |
|--------------------|----------------------|------------------------------------------|
| Start, Stop        | 9 kHz to 3.0 GHz     | 100 kHz to 4.5 GHz (8.5 GHz)             |
| Center             | >9 kHz to <3.0 GHz   | >9 kHz to <3.0 GHz (8.5 GHz)             |
| Span               | 1 Hz to 2.999991 GHz | 1 Hz to 4.499991 GHz (8.499991 GHz)      |

[SENSe<Ch>:]FREQUENCY:CENTer.....643  
 [SENSe<Ch>:]FREQUENCY:CONVersion..... 644  
 [SENSe<Ch>:]FREQUENCY:CONVersion:GAIN:LMCorrection..... 644  
 [SENSe<Ch>:]FREQUENCY[:CW]..... 645  
 [SENSe<Ch>:]FREQUENCY:FIXed..... 645  
 [SENSe<Ch>:]FREQUENCY:SBANd..... 645  
 [SENSe<Ch>:]FREQUENCY:SEGMENT:AXIS..... 646  
 [SENSe<Ch>:]FREQUENCY:SPAN..... 647  
 [SENSe<Ch>:]FREQUENCY:START..... 647  
 [SENSe<Ch>:]FREQUENCY:STOP..... 647

**[SENSe<Ch>:]FREQUENCY:CENTer <CenterFreq>**

Defines the center of the measurement and display range for a frequency sweep (sweep range). The default center frequency is the center of the analyzer's maximum frequency range:  $(f_{MIN} + f_{MAX})/2$ . The range is listed in table [Table 6-9](#).

**Suffix:**

<Ch> Channel number

**Parameters:**

<CenterFreq> Center frequency of the sweep  
Increment: 0.1 kHz  
Default unit: Hz

**Example:**

```
*RST; :SYST:FREQ? MIN; :SYST:FREQ? MAX
Query the frequency range of the analyzer.
FREQ:CENT 100MHz
Set center frequency to 100 MHz.
FREQ:SPAN 50000
Set frequency span to 50 kHz.
```

**Manual operation:** See "[Start / Stop / Center / Span Frequency \(Power / Time\)](#)" on page 229

**Note:** The measurement range defined by means of the center frequency and the current span (`[SENSe<Ch>:]FREQuency:SPAN`) must not exceed the allowed frequency range of the analyzer. If necessary, the span is reduced to  $\min(\text{<CenterFreq>} - f_{\text{MIN}}, f_{\text{MAX}} - \text{<CenterFreq>})$ .

**[SENSe<Ch>:]FREQuency:CONVersion <ConversionMode>**

Enables a frequency conversion measurement mode for channel <Ch>.

**Suffix:**

<Ch> Channel number

**Parameters:**

<ConversionMode> FUNDamental | ARBitrary  
FUNDamental - measurement of the fundamental signal (no frequency-converting mode). This selection cancels all port-specific frequency and power settings (see example).  
ARBitrary - frequency conversion mode (arbitrary port frequencies). This mode is automatically activated when a port-specific frequency is defined.  
MIXer scalar mixer mode. The mixer mode is configured using the `[SENSe<Ch>:]FREQuency:CONVersion:MIXer...` commands.  
**\*RST:** FUNDamental

**Example:** See `SOURce<Ch>:FREQuency<PhyPt>:CONVersion:ARBitrary:IFRequency`

**[SENSe<Ch>:]FREQuency:CONVersion:GAIN:LMCorrection <Boolean>**

Enables or disables the load match correction for frequency conversion transmission S-parameters (conversion gain factors).

**Suffix:**

<Ch> Channel number

**Parameters:**

<Boolean> \*RST: ON

**Example:**

See `SOURce<Ch>:FREQUency<PhyPt>:CONVersion:ARBitrary:IFRequency`

**[SENSe<Ch>:]FREQUency[:CW] <FixedFreq>**

**[SENSe<Ch>:]FREQUency:FIXed <FixedFreq>**

Defines the fixed (Continuous Wave, CW) frequency for all sweep types operating at fixed frequency (power sweep, time sweep, CW mode sweep). The two command forms `[SENSe<Ch>:]FREQUency[:CW]` and `[SENSe<Ch>:]FREQUency:FIXed` are equivalent.

The frequency range is listed in [Table 6-9](#).

**Note:** `[SENSe<Ch>:]FREQUency[:CW] | :FIXed` is equivalent to `SOURce<Ch>:FREQUency<PhyPt>[:CW] | :FIXed`. Source and receiver frequency are always equal; the four commands overwrite each other.

**Suffix:**

<Ch> Channel number

**Parameters:**

<FixedFreq> Fixed stimulus and analyzer frequency  
Increment: 0.1 kHz  
\*RST: 1 GHz  
Default unit: Hz

**Example:**

```
FUNC "XPOW:POW:A1"
```

Activate a power sweep and select the wave quantity  $a_1$  as measured parameter for channel and trace no. 1.

```
FREQ: CW 100MHz
```

Set the CW frequency to 100 MHz.

**Manual operation:** See "[CW Frequency](#)" on page 230

**[SENSe<Ch>:]FREQUency:SBANd <Sideband>**

Defines whether the analyzer measures with a local oscillator frequency LO below or above the RF input frequency.

**Tip:** In a segmented frequency sweep, it is possible to set the sideband (SBANd) parameter individually for each segment; see `[SENSe<Ch>:]SEGMENT<Seg>:DEFine`. The `[SENSe<Ch>:]FREQUency:SBANd` setting is global and not valid for segmented sweeps. The two sideband settings do not overwrite each other.

**Suffix:**

<Ch> Channel number. This suffix is ignored; the setting applies to all channels in the active recall set.

**Parameters:**

&lt;Sideband&gt;

POSitive | NEGative | AUTO

**POSitive**

LO > RF; the LO frequency is always above the measured RF frequency.

**NEGative**

LO < RF; the LO frequency is always below the measured RF frequency.

**AUTO**

The analyzer auto-selects the LO frequency, depending on the receiver (RF) frequency.

**Note:** For a unidirectional R&S ZND (see [Chapter 3.1.4.2, "R&S ZND: Unidirectional vs. Bidirectional Operation"](#), on page 16) this setting is ignored: only AUTO mode is supported.

\*RST:        AUTO

**Example:**

```
*RST; :SWE:TYPE?; :FREQ:SBAN?
```

Query the \*RST values for the sweep type and the sideband setting. The response is `LIN` (linear frequency sweep) and `AUTO` (automatic setting of the LO frequency).

**Manual operation:** See ["Image Suppr."](#) on page 301

**[SENSe<Ch>:]FREQuency:SEGMent:AXIS <Scale>**

Selects either frequency based or point based x-axis for segmented sweeps.

**Suffix:**

&lt;Ch&gt;

Channel number

**Parameters:**

&lt;Scale&gt;

POINT | FREQuency

**Example:**

```
SENSe:SEGMent:INSert 1MHZ, 1.1MHZ, 101, -21DBM,
0.5S, 0, 10KHZ
```

```
SENSe:SEGMent:INSert 2MHZ, 3MHZ, 101, -21DBM,
0.5S, 0, 10KHZ
```

Create two sweep segments with different frequency spans, each with 101 sweep points.

```
SENSe:SEGMent:FREQuency:AXIS POINT
```

Select the point based frequency axis. The first 101 sweep points are distributed over the left half of the diagram, the second 101 points over the right half.

**Manual operation:** See ["Seg x-Axis"](#) on page 243

**[SENSe<Ch>:]FREQUENCY:SPAN <Span>**

Defines the width (span) of the measurement and display range for a frequency sweep (sweep range). The default span equals to the maximum frequency range of the analyzer:  $f_{MAX} - f_{MIN}$ . The range is listed in table [Table 6-9](#).

**Suffix:**

<Ch> Channel number

**Parameters:**

<Span> Frequency span of the sweep  
 Increment: 0.1 kHz  
 Default unit: Hz

**Example:** See `[SENSe<Ch>:]FREQUENCY:CENTer`

**Manual operation:** See "Start / Stop / Center / Span Frequency (Power / Time)" on page 229

**Note:** The measurement range defined by means of the span and the current center frequency (`[SENSe<Ch>:]FREQUENCY:CENTer`), must not exceed the allowed frequency range of the analyzer. If necessary, the center frequency is adjusted to  $f_{MIN} + \langle Span \rangle / 2$  or  $f_{MAX} - \langle Span \rangle / 2$ .

**[SENSe<Ch>:]FREQUENCY:START <StartFreq>****[SENSe<Ch>:]FREQUENCY:STOP <StopFreq>**

These commands defines the start and stop frequency for a frequency sweep. The values also define display range in a Cartesian diagram. The default start and stop frequencies equal to the minimum and maximum frequency of the analyzer.

The ranges are listed in table [Table 6-9](#).

**Suffix:**

<Ch> Channel number

**Parameters:**

<StopFreq> Start and stop frequency of the sweep  
 Increment: 0.1 kHz  
 Default unit: Hz

**Example:** `*RST; FREQ:STAR 100000`  
 Activate a frequency sweep and set the start frequency to 100 kHz.  
`FREQ:STOP 10MHz`  
 Set the stop frequency to 10 MHz.

**Manual operation:** See "Start / Stop / Center / Span Frequency (Power / Time)" on page 229

**Note:** If the start frequency entered is greater than the current stop frequency, the stop frequency is set to the start frequency plus the minimum frequency span (`[SENSe<Ch>:]FREQUENCY:SPAN`).

If the stop frequency entered is smaller than the current start frequency, the start frequency is set to the stop frequency minus the minimum frequency span.

### 6.3.15.9 [SENSe:]HARMonic...

Implements functions related to harmonic grids for time domain transformation.

---

#### [SENSe<Ch>:]HARMonic:AUTO <arg0>

Turns the "Automatic Harmonic Grid" function ON or OFF.

**Suffix:**

<Ch> Channel number

**Parameters:**

<arg0> \*RST: ON

**Options:** R&S ZNC/ZND-K2

**Manual operation:** See "[Automatic Harmonic Grid](#)" on page 178

---

#### [SENSe<Ch>:]HARMonic:DLEnGth:DATA <DUTLength>

Sets/gets the expected maximum time delay through the DUT.

The set command automatically activates the "Automatic Harmonic Grid" function, i.e. it sets [\[SENSe<Ch>:\]HARMonic:AUTO](#) to ON.

**Suffix:**

<Ch> Channel number

**Parameters:**

<DUTLength> Default unit: s

**Options:** R&S ZNC/ZND-K20

---

#### [SENSe<Ch>:]HARMonic:RTIME:DATA <DUTRiseTime>

Sets/gets the minimum rise time the user wishes to measure on the DUT.

Use [\[SENSe<Ch>:\]HARMonic:RTIME:THReshold](#) to select the underlying rise time definition.

The set command automatically activates the "Automatic Harmonic Grid" function, i.e. it sets [\[SENSe<Ch>:\]HARMonic:AUTO](#) to ON.

**Suffix:**

<Ch> Channel number

**Parameters:**

<DUTRiseTime> Default unit: s

**Options:** R&S ZNC/ZND-K20



**[SENSe<Ch>:]HARMonic:RTIME:THReshold <DUTRiseThreshold>**

Defines how the rise time that is set using `[SENSe<Ch>:]HARMonic:RTIME:DATA` shall be interpreted. Allows to select between rise time definitions 20%-80% (default) and 10%-90%.

The set command automatically activates the "Automatic Harmonic Grid" function, i.e. it sets `[SENSe<Ch>:]HARMonic:AUTO` to ON.

**Suffix:**

<Ch> Channel number

**Parameters:**

<DUTRiseThreshold> T1\_9 | T2\_8

Rise time definition:

**T1\_9:** 10%-90%

**T2\_8:** 20%-80%

\*RST: T2\_8

**Options:** R&S ZNC/ZND-K20

**6.3.15.10 [SENSe:]LPORt...**

The `[SENSe:]LPORt...` commands define the reference impedances of the balanced ports.

|                                                                          |     |
|--------------------------------------------------------------------------|-----|
| <code>[SENSe&lt;Ch&gt;:]LPORt&lt;LogPt&gt;:ZCOMmon</code> .....          | 649 |
| <code>[SENSe&lt;Ch&gt;:]LPORt&lt;LogPt&gt;:ZDIFferent</code> .....       | 649 |
| <code>[SENSe&lt;Ch&gt;:]LPORt&lt;LogPt&gt;:ZDEFault[:STATe]</code> ..... | 650 |

**[SENSe<Ch>:]LPORt<LogPt>:ZCOMmon <RealPart>[, <ImaginaryPart>]**

**[SENSe<Ch>:]LPORt<LogPt>:ZDIFferent <RealPart>[, <ImaginaryPart>]**

These commands specify the complex common mode and differential mode reference impedances for the balanced (logical) port numbered <LogPt>.

Use `[SENSe<Ch>:]LPORt<LogPt>:ZDEFault[:STATe]` to toggle between configured and default reference impedances.

**Note:** For a unidirectional R&S ZND (see [Chapter 3.1.4.2, "R&S ZND: Unidirectional vs. Bidirectional Operation"](#), on page 16) balanced ports are not supported and hence these commands are not available.

**Suffix:**

<Ch> Channel number

<LogPt> Logical port number. The logical ports must be defined using `SOURce<Ch>:LPORt<LogPt><PhysicalPort1>,<PhysicalPort2>`. An n port analyzer supports a maximum of n/2 (n even) or (n - 1)/2 (n odd) logical ports.

**Parameters:**

|                 |                                                                                                                                                                 |
|-----------------|-----------------------------------------------------------------------------------------------------------------------------------------------------------------|
| <RealPart>      | Real part of the port impedance.<br>Range: 1 mΩ to 10 MΩ<br>*RST: ZCOMmon: 25 Ω; ZDIFferent: 100 Ω (real impedances)<br>Default unit: Ohm                       |
| <ImaginaryPart> | Imaginary part of the port impedance; may be omitted to define a real impedance.<br>Range: - 10 MΩ to 10 MΩ<br>*RST: 0 Ω (real impedances)<br>Default unit: Ohm |

**Example:**

```
*RST; :CALC:PAR:DEL 'TRC1'
```

Reset the analyzer and delete the (default) trace for channel no. 1.

```
SOUR:LPOR1 1,2
```

Combine the physical ports no. 1 and 2 to define the balanced (logical) port no. 1.

```
LPOR1:ZDIF 27, 2
```

Specify a complex differential mode reference impedance of  $27\Omega + j \cdot 2\Omega$  for the defined port.

**Manual operation:** See ["Single Ended Mode / Common Mode / Differential Mode"](#) on page 135

**[SENSe<Ch>:]LPORt<LogPt>:ZDEFault[:STATe] <arg0>**

Allows to toggle between default and renormalized reference impedance(s) for logical port <LogPt>.

**Suffix:**

|         |                     |
|---------|---------------------|
| <Ch>    | Channel number      |
| <LogPt> | Logical port number |

**Parameters:**

|        |                                                                                                                                                                                                                                                                                                                                          |
|--------|------------------------------------------------------------------------------------------------------------------------------------------------------------------------------------------------------------------------------------------------------------------------------------------------------------------------------------------|
| <arg0> | ON (1): Use default impedance(s)<br>OFF (0): Use the redefined impedances defined via <a href="#">[SENSe&lt;Ch&gt;:]PORT&lt;PhyPt&gt;:ZREFerence</a> for single-ended or via <a href="#">[SENSe&lt;Ch&gt;:]LPORt&lt;LogPt&gt;:ZCOMmon</a> and <a href="#">[SENSe&lt;Ch&gt;:]LPORt&lt;LogPt&gt;:ZDIFferent</a> for balanced logical ports |
|--------|------------------------------------------------------------------------------------------------------------------------------------------------------------------------------------------------------------------------------------------------------------------------------------------------------------------------------------------|

**Manual operation:** See ["Use Default"](#) on page 135

**6.3.15.11 [SENSe:]PORT...**

The [\[SENSe:\]PORT...](#) commands define the reference impedances at the physical ports.

**[SENSe<Ch>:]PORT<PhyPt>:ZREFerence <RealPart>[, <ImaginaryPart>]**

Specifies the complex reference impedance for the physical port numbered <PhyPt> (impedance renormalization).

Use [SENSe<Ch>:]LPORT<LogPt>:ZDEFault[:STATe] to toggle between configured and default reference impedances.

**Suffix:**

|         |                      |
|---------|----------------------|
| <Ch>    | Channel number       |
| <PhyPt> | Physical port number |

**Parameters:**

|                 |                                                                                                                                                                                                                                                           |
|-----------------|-----------------------------------------------------------------------------------------------------------------------------------------------------------------------------------------------------------------------------------------------------------|
| <RealPart>      | Real part of the port impedance.<br>Range: 1 mΩ to 10 MΩ<br>*RST: Default reference impedance of the connector family assigned to the port (real impedance, e.g. 50 Ω).<br>Default unit: Ohm                                                              |
| <ImaginaryPart> | Imaginary part of the port impedance. This part may be omitted to define a real impedance.<br>Range: - 10 MΩ to 10 MΩ<br>*RST: Default reference impedance of the connector family assigned to the port (real impedance, e.g. 50 Ω).<br>Default unit: Ohm |

**Example:**

```
PORT2:ZREF 52, 2
```

Specify a complex reference impedance of 52 Ω + j \* 2 Ω for the (physical) port no. 2.

```
CALC:TRAN:IMP:RNOR PWAV
```

Select renormalization of port impedances according to the power waves theory.

**Manual operation:** See "Single Ended Mode / Common Mode / Differential Mode" on page 135

**6.3.15.12 [SENSe:]POWer...**

The [SENSe:]POWer... commands configure the automatic/adaptive gain control (AGC) of the R&S ZNC/ZND.

See also [SENSe<Ch>:]SEGMENT<Seg>:POWer:GAINcontrol on page 665.

|                                               |     |
|-----------------------------------------------|-----|
| [SENSe<Ch>:]POWer:GAINcontrol.....            | 652 |
| [SENSe<Ch>:]POWer:GAINcontrol:GLOBal.....     | 652 |
| [SENSe<Ch>:]POWer:AGCMode:ACQuire.....        | 653 |
| [SENSe<Ch>:]POWer:AGCMode:SAVE.....           | 653 |
| [SENSe<Ch>:]POWer:AGCMode<PhyPt>:MEASure..... | 654 |
| [SENSe<Ch>:]POWer:IFGain<PhyPt>:MEASure.....  | 654 |

**[SENSe<Ch>:]POWER:GAINcontrol <ReceiverName>, <Mode>**  
**[SENSe<Ch>:]POWER:GAINcontrol? <ReceiverName>**

Defines port-specific gain settings.

**Note:**

- This command is not available for the R&S ZND.
- Without the [Extended Power Range](#) option only the gain of the measurement receivers (the b-waves) can be statically set (to LNOise or LDISTortion); the reference receiver always uses automatic gain control (AUTO). With the option available, also the gain of the reference receivers (the a-waves) can be set statically.
- If you also want to distinguish between different sweep segments, use [\[SENSe<Ch>:\]SEGMENT<Seg>:POWER:GAINcontrol](#) instead.

**Suffix:**

<Ch> Channel number

**Parameters:**

<Mode> LNOise | LDISTortion | AUTO  
 AUTO – automatic/adaptive gain control (AGC) according to the RF input level.  
 LNOise – fixed, large IF gain, for low input levels.  
 LDISTortion – fixed, small IF gain, for high input levels.

**Parameters for setting and query:**

<ReceiverName> String parameter defining the wave(s) followed by the drive port; see examples below and [Table 6-4](#).

**Example:**

```
*RST; :SENSe:POWer:GAINcontrol:GLOBal MANual
Activate independent AGC settings for each drive port.
SENSe:POWer:GAINcontrol 'B2D1', LNO
Set the AGC for the received wave b2 (port 2) to "Low Noise".
The setting applies while port 1 is the drive port.
SENSe:POWer:GAINcontrol 'A2B2B3D2', LNO
Set the AGC for the waves a2, b2, and b3 to "Low Noise". The
setting applies while port 2 is the drive port.
SENSe:POWer:GAINcontrol? 'B1D2'
Query the AGC setting for the wave b1 while port 2 is the drive
port. The response is 1, LDIS (default setting).
```

**Manual operation:** See "[Manual Config...](#)" on page 303

**[SENSe<Ch>:]POWER:GAINcontrol:GLOBal <AGCModesGlobal>**

Globally configures the gain control in all receive paths (measurement receivers, b-waves) for all analyzer ports or enables port-specific gain control configuration.

**Note:**

This command is not available for the R&S ZND.

**Suffix:**

<Ch> Channel number

**Parameters:**

<AGCModesGlobal> LNOise | LDISTortion | AUTO | MANual

AUTO – automatic/adaptive gain control (AGC) according to the RF input level.

LNOise – static, large IF gain, for low input levels.

LDISTortion – static, small IF gain, for high input levels.

MANual – enables the manual configuration of independent AGC settings for each drive port, see [SENSe<Ch>:]POWer:GAINcontrol and [SENSe<Ch>:]SEGMENT<Seg>:POWer:GAINcontrol.

\*RST: AUTO

**Example:** See [SENSe<Ch>:]POWer:GAINcontrol

**Manual operation:** See "AGC Mode" on page 302

**[SENSe<Ch>:]POWer:AGCMode:ACQUIRE**

Starts an AGC learn sweep.

**Note:**

This command is not available for the R&S ZND.

**Suffix:**

<Ch> Channel number

**Example:**

Before you start, make sure channel 1 is fully configured (ports, traces, ...).

```
*RST; :SENSe1:POWer:GAINcontrol:GLOBAL MANual
```

Activate independent AGC settings for each drive port.

```
SENSe1:POWer:AGCMode:ACQUIRE;*WAI
```

Perform a Learn Sweep and wait until it has completed (asynchronous command)

```
SENSe1:POWer:AGCMode:SAVE
```

Apply the acquired AGC settings to channel 1.

**Usage:** Event

**Manual operation:** See "Manual Config..." on page 303

**[SENSe<Ch>:]POWer:AGCMode:SAVE**

Apply the static AGC (Automatic Gain Control) settings obtained during an AGC Learning Sweep.

**Note:**

This command is not available for the R&S ZND.

**Suffix:**  
 <Ch> Channel number

**Example:** see `[SENSe<Ch>:]POWer:AGCMode:ACQuire`

**Usage:** Event

**Manual operation:** See "Manual Config..." on page 303

`[SENSe<Ch>:]POWer:AGCMode<PhyPt>:MEASure <Mode>`  
`[SENSe<Ch>:]POWer:IFGain<PhyPt>:MEASure <AGCMode>`

These two equivalent commands activate manual gain control and select the IF gain in the measurement channels (b-waves). The IF gain in the reference channel (a-waves) is set automatically if not otherwise defined using `[SENSe<Ch>:]POWer:GAINcontrol`.

**Note:**

This command is not available for the R&S ZND.

These commands are replaced by `[SENSe<Ch>:]POWer:GAINcontrol` and `[SENSe<Ch>:]POWer:GAINcontrol:GLOBal`. They are supported for compatibility with FW versions < 1.5.

**Suffix:**  
 <Ch> Channel number  
 <PhyPt> Test port number of the analyzer

**Parameters:**  
 <AGCMode> LNOise | LDISTortion | AUTO  
 AUTO – automatic/adaptive gain control (AGC) according to the RF input level.  
 LNOise – fixed, large IF gain, for low input levels.  
 LDISTortion – fixed, small IF gain, for high input levels.  
 \*RST: LDIS

**Example:** `*RST; :SENSe:POWer:IFG2:MEAS LNO; :SENSe:POWer:IFG1:MEAS?`  
 Optimize the received waves (measurement channel, b-waves) at port 2 for small input levels and query the AGC settings for the received waves at port 1. The response is LDIS.

**6.3.15.13 [SENSe:]ROSCillator...**

The `[SENSe:]ROSCillator...` commands control the frequency reference signal.

`[SENSe<Ch>:]ROSCillator:EXTernal:FREQuency`..... 654  
`[SENSe<Ch>:]ROSCillator[:SOURce]`..... 655

`[SENSe<Ch>:]ROSCillator:EXTernal:FREQuency <ExtClockFreq>`

Specifies or queries the frequency of the external reference oscillator.

|                          |                                                                                                                                                   |
|--------------------------|---------------------------------------------------------------------------------------------------------------------------------------------------|
| <b>Suffix:</b>           |                                                                                                                                                   |
| <Ch>                     | Channel number. This suffix is ignored in the ROscillator subsystem and can be set to any value.                                                  |
| <b>Parameters:</b>       |                                                                                                                                                   |
| <ExtClockFreq>           | Frequency of the external reference clock signal. The frequency must be 10 MHz; any other setting is ignored.<br>*RST: 10 MHz<br>Default unit: Hz |
| <b>Example:</b>          | See <code>[SENSe&lt;Ch&gt;:]ROScillator[:SOURce]</code>                                                                                           |
| <b>Manual operation:</b> | See "Ext Frequency" on page 346                                                                                                                   |

---

### `[SENSe<Ch>:]ROScillator[:SOURce] <Source>`

Selects the source of the reference oscillator signal.

|                          |                                                                                                                                                                                                                                       |
|--------------------------|---------------------------------------------------------------------------------------------------------------------------------------------------------------------------------------------------------------------------------------|
| <b>Suffix:</b>           |                                                                                                                                                                                                                                       |
| <Ch>                     | Channel number. This suffix is ignored in the ROscillator subsystem and can be set to any value.                                                                                                                                      |
| <b>Parameters:</b>       |                                                                                                                                                                                                                                       |
| <Source>                 | INTernal   EXTernal<br>INTernal - select internal 10 MHz reference oscillator.<br>EXTernal - select external 10 MHz reference clock.<br>*RST: INTernal                                                                                |
| <b>Example:</b>          | ROSC EXT<br>Select external reference oscillator.<br>ROSC:EXT:FREQ?<br>Query the frequency of the external reference oscillator. The response is 10000000 Hz, i.e. the frequency of the external reference oscillator must be 10 MHz. |
| <b>Manual operation:</b> | See "Internal / External" on page 345                                                                                                                                                                                                 |

#### 6.3.15.14 `[SENSe:]SEGMENT<Seg>...`

The `[SENSe:]SEGMENT<Seg>...` commands define all channel settings for a segmented frequency sweep. A segmented sweep is activated via `[SENSe<Ch>:]SWEep:TYPE SEGMENT`.



The commands in this subsystem do not accept the step parameters UP and DOWN. Numeric values can be entered directly or using the DEFault, MINimum, MAXimum parameters.

|                                                                                     |     |
|-------------------------------------------------------------------------------------|-----|
| <code>[SENSe&lt;Ch&gt;:]SEGMENT&lt;Seg&gt;:ADD</code> .....                         | 656 |
| <code>[SENSe&lt;Ch&gt;:]SEGMENT&lt;Seg&gt;:BWIDth[:RESolution]</code> .....         | 657 |
| <code>[SENSe&lt;Ch&gt;:]SEGMENT&lt;Seg&gt;:BWIDth[:RESolution]:CONTrol</code> ..... | 657 |
| <code>[SENSe&lt;Ch&gt;:]SEGMENT:COUNT?</code> .....                                 | 658 |

|                                                         |     |
|---------------------------------------------------------|-----|
| [SENSe<Ch>:]SEGMENT<Seg>:DEFine.....                    | 658 |
| [SENSe<Ch>:]SEGMENT<Seg>:DEFine:SElect.....             | 660 |
| [SENSe<Ch>:]SEGMENT<Seg>:DELeTe:ALL.....                | 660 |
| [SENSe<Ch>:]SEGMENT<Seg>:DELeTe[:DUMMy].....            | 661 |
| [SENSe<Ch>:]SEGMENT<Seg>:FREQUency:CENTer?.....         | 661 |
| [SENSe<Ch>:]SEGMENT<Seg>:FREQUency:SPAN?.....           | 661 |
| [SENSe<Ch>:]SEGMENT<Seg>:FREQUency:START.....           | 662 |
| [SENSe<Ch>:]SEGMENT<Seg>:FREQUency:STOP.....            | 662 |
| [SENSe<Ch>:]SEGMENT<Seg>:INSert.....                    | 662 |
| [SENSe<Ch>:]SEGMENT<Seg>:INSert:SElect.....             | 664 |
| [SENSe<Ch>:]SEGMENT<Seg>:POWer[:LEVel].....             | 665 |
| [SENSe<Ch>:]SEGMENT<Seg>:POWer:GAINcontrol.....         | 665 |
| [SENSe<Ch>:]SEGMENT<Seg>:POWer:GAINcontrol:CONTrol..... | 666 |
| [SENSe<Ch>:]SEGMENT<Seg>:POWer[:LEVel]:CONTrol.....     | 667 |
| [SENSe<Ch>:]SEGMENT<Seg>[:STATe].....                   | 668 |
| [SENSe<Ch>:]SEGMENT<Seg>:SWEep:DWELI.....               | 668 |
| [SENSe<Ch>:]SEGMENT<Seg>:SWEep:DWELI:CONTrol.....       | 669 |
| [SENSe<Ch>:]SEGMENT<Seg>:SWEep:POINts.....              | 669 |
| [SENSe<Ch>:]SEGMENT<Seg>:SWEep:TIME.....                | 670 |
| [SENSe<Ch>:]SEGMENT<Seg>:SWEep:TIME:CONTrol.....        | 671 |
| [SENSe<Ch>:]SEGMENT<Seg>:SWEep:TIME:SUM?.....           | 671 |

---

### [SENSe<Ch>:]SEGMENT<Seg>:ADD

Inserts a new sweep segment using default channel settings ("Insert New Segment"). The added segment covers the frequency interval between the maximum frequency of the existing sweep segments and the stop frequency of the entire sweep range.

**Tip:** Use [SENSe<Ch>:]SEGMENT<Seg>:INSert to create a segment with specific channel settings.

#### Suffix:

|       |                                                                                                                                            |
|-------|--------------------------------------------------------------------------------------------------------------------------------------------|
| <Ch>  | Channel number                                                                                                                             |
| <Seg> | Sweep segment number. Segment numbers must be sequential. If n segments exist already, the added segment must have the segment number n+1. |

#### Example:

```
SEGM:INS 1MHZ, 1.5MHZ, 111, -21DBM, 0.5S, 0,
10KHZ
```

Create a sweep segment with a sweep range between 1.0 MHz and 1.5 MHz.

```
SEGM2:ADD
```

Create a second sweep segment. The frequency range of the second segment will be between 1.5 MHz and the maximum frequency of the analyzer.

**Usage:** Event

**Manual operation:** See "Add / Insert / Delete / Delete All" on page 245



**[SENSe<Ch>:]SEGMENT<Seg>:BWIDth[:RESolution] <ResBandwidth>**

Defines the resolution bandwidth of the analyzer (Meas. Bandwidth) in sweep segment no. <Seg>. Values between 1 Hz and 100 kHz can be set.

Bandwidths can be set in 1 – 1.5 – 2 – 3 – 5 – 7 steps. The analyzer rounds up any entered value between these steps and rounds down values exceeding the maximum bandwidth.

At the same time, the command activates separate bandwidth setting in all sweep segments (`[SENSe<Ch>:]SEGMENT<Seg>:BWIDth[:RESolution]:CONTROLON`).

**Suffix:**

<Ch> Channel number  
<Seg> Sweep segment number

**Parameters:**

<ResBandwidth> Resolution bandwidth  
Range: See above  
Increment: 1-1.5-2-3-5-7 steps  
\*RST: 10 kHz  
Default unit: Hz

**Example:** See `[SENSe<Ch>:]SEGMENT<Seg>:BWIDth[:RESolution]:CONTROL`

**Manual operation:** See "Table Columns" on page 248

**[SENSe<Ch>:]SEGMENT<Seg>:BWIDth[:RESolution]:CONTROL <Boolean>**

Selects common or independent "Meas. Bandwidth" settings for the sweep segments.

**Suffix:**

<Ch> Channel number  
<Seg> Sweep segment number. This suffix is ignored; the setting controls the whole segmented sweep.

**Parameters:**

<Boolean> ON – use independent bandwidth settings, to be defined via `[SENSe<Ch>:]SEGMENT<Seg>:BWIDth[:RESolution]`.  
OFF – reset the bandwidth in all sweep segments to the bandwidth for unsegmented sweeps, defined via `[SENSe<Ch>:]BWIDth[:RESolution]`. ON will not restore the previous values.  
The parameter is automatically switched to ON when a bandwidth is entered using `[SENSe<Ch>:]SEGMENT<Seg>:BWIDth[:RESolution]`.  
\*RST: OFF

**Example:**                    \*RST; :SENS:SEGM:ADD  
 Create a new sweep segment no. 1 in channel no. 1 using default settings and thus 10 kHz measurement bandwidth.  
 SEGM:BWID 1 MHZ  
 Increase the resolution bandwidth to 1 MHz.  
 SEGM:BWID:CONT OFF  
 Couple the bandwidths in all segments and reset the bandwidth in segment no. 1 to the initial value.

**Manual operation:** See "Table Columns" on page 248

### [SENSe<Ch>:]SEGMENT:COUNT?

Returns the number of sweep segments in the channel including all segments that are switched off ([SENSe<Ch>:] SEGMENT<Seg>[:STATe] OFF).

**Suffix:**  
 <Ch>                    Channel number

**Example:**                    SEGM:ADD  
 Create a new sweep segment no. 1 in channel no. 1 using default settings.  
 SEGM OFF  
 Disable the measurement in the created sweep segment.  
 SEGM:COUN?  
 Query the number of segments.

**Usage:**                    Query only

**Manual operation:** See "Table Columns" on page 245

### [SENSe<Ch>:]SEGMENT<Seg>:DEFine <StartFreq>, <StopFreq>, <Points>, <Power>, <SegmentTime>|<MeasDelay>, <Unused>, <MeasBandwidth>[, <LO>, <Selectivity>, <FreqSweepMode>]

Creates or re-defines a sweep segment no. <Seg> with specific channel settings.

Entry of the first seven numeric parameters is mandatory; no default values are provided. All settings except <LO> can be changed for existing segments using other commands of the [SENSe<Ch>:] SEGMENT<Seg>... subsystem.

**Note:** Use [SENSe<Ch>:] SEGMENT<Seg>:ADD to create a segment with default channel settings. Use [SENSe<Ch>:] SEGMENT<Seg>:INSert (no query) to insert a new segment into the current segment list.

**Suffix:**  
 <Ch>                    Channel number  
 <Seg>                    Sweep segment number. Segment numbers must be sequential. The specified segment number must be smaller or equal to the number of existing segments plus 1. If segment number <Seg> already exists, it is replaced by the new segment.

**Parameters:**

|                 |                                                                                                                                                                                                                                                                                                                                                                                                                                                       |
|-----------------|-------------------------------------------------------------------------------------------------------------------------------------------------------------------------------------------------------------------------------------------------------------------------------------------------------------------------------------------------------------------------------------------------------------------------------------------------------|
| <StartFreq>     | Start frequency of the segment; see <a href="#">[SENSe&lt;Ch&gt; : ] SEGMENT&lt;Seg&gt; : FREQuency : START</a> .<br>Default unit: Hz                                                                                                                                                                                                                                                                                                                 |
| <StopFreq>      | Stop frequency of the segment; see <a href="#">[SENSe&lt;Ch&gt; : ] SEGMENT&lt;Seg&gt; : FREQuency : STOP</a> .<br>Default unit: Hz                                                                                                                                                                                                                                                                                                                   |
| <Points>        | Number of sweep points in the segment. See <a href="#">[SENSe&lt;Ch&gt; : ] SEGMENT&lt;Seg&gt; : SWEep : POINTs</a> .                                                                                                                                                                                                                                                                                                                                 |
| <Power>         | Internal source power in the segment. See <a href="#">[SENSe&lt;Ch&gt; : ] SEGMENT&lt;Seg&gt; : POWer [ : LEVel ]</a> .<br>Default unit: dBm                                                                                                                                                                                                                                                                                                          |
| <SegmentTime>   | Duration of the sweep in the segment. See <a href="#">[SENSe&lt;Ch&gt; : ] SEGMENT&lt;Seg&gt; : SWEep : TIME</a> . In the setting <a href="#">[SENSe&lt;Ch&gt; : ] SEGMENT&lt;Seg&gt; : INSErt : SELEct DWELL</a> , this parameter is replaced by <MeasDelay>. <p>Range: Depending on other channel settings. AUTO activates automatic sweep time setting in the segment, which is equivalent to the minimum sweep time possible.</p> Default unit: s |
| <MeasDelay>     | Delay for each partial measurement in the segment. See <a href="#">[SENSe&lt;Ch&gt; : ] SEGMENT&lt;Seg&gt; : SWEep : DWELL</a> . In the setting <a href="#">[SENSe&lt;Ch&gt; : ] SEGMENT&lt;Seg&gt; : INSErt : SELEct SWTime</a> , this parameter is replaced by <SegmentTime>.                                                                                                                                                                       |
| <Unused>        | Ignored parameter (for compatibility with R&S ZVR analyzers). Should be set to the default value 0.                                                                                                                                                                                                                                                                                                                                                   |
| <MeasBandwidth> | Resolution bandwidth in the segment. See <a href="#">[SENSe&lt;Ch&gt; : ] SEGMENT&lt;Seg&gt; : BWIDth [ : RESolution ]</a> .<br>Default unit: Hz                                                                                                                                                                                                                                                                                                      |
| <LO>            | POSitive   NEGative   AUTO<br>Position of the local oscillator frequency LO relative to the RF frequency. In remote control this parameter must be set when a sweep segment is created. See <a href="#">[SENSe&lt;Ch&gt; : ] FREQuency : SBAND</a> .                                                                                                                                                                                                  |
| <Selectivity>   | NORMal<br>Selectivity of the IF filter; must be set to NORMal.                                                                                                                                                                                                                                                                                                                                                                                        |
| <FreqSweepMode> | STEPped<br>Frequency sweep mode; must be set to Stepped.                                                                                                                                                                                                                                                                                                                                                                                              |

**Example:**                   SEGM:ADD  
 Create a new sweep segment no. 1 in channel no. 1 using default settings.  
 SEGM:DEF?  
 Query the channel settings for the new segment. A possible response is  
 1000000000,2000000000,51,-300,0.0044625,0,  
 10000,AUTO,NORM,STEP.

**Manual operation:** See "Table Columns" on page 248

### [SENSe<Ch>:]SEGMENT<Seg>:DEFine:SElect <TimeRef>

Defines whether the sweep time of a new segment, i.e. numeric parameter no. 5 of the command [SENSe<Ch>:]SEGMENT<Seg>:DEFine, is entered as a segment sweep time ("Segment Time") or as a measurement delay ("Meas Delay").

**Suffix:**

<Ch>                   Channel number  
 <Seg>                   Sweep segment number

**Parameters:**

<TimeRef>           SWTime | DWELI  
 SWTime - use segment sweep time.  
 DWELI - use measurement delay.

**Example:**                   SEG1:DEF:SEL DWEL  
 Select the measurement delay to determine the sweep time in a new sweep segment no. 1.  
 SEG1:DEF 1MHZ, 1.5MHZ, 111, -21DBM, 0.01S, 0, 10KHZ  
 Create a sweep segment with a sweep range between 1.0 MHz and 1.5 MHz and a measurement delay of 10 ms.  
 SEG1:SWE:TIME?  
 Query the sweep time in the new segment.

**Manual operation:** See "Table Columns" on page 248

### [SENSe<Ch>:]SEGMENT<Seg>:DELeTe:ALL

Deletes all sweep segments in the channel. [SENSe<Ch>:]SEGMENT<Seg>:DELeTe[:DUMMy] deletes a single segment.

**Suffix:**

<Ch>                   Channel number  
 <Seg>                   Sweep segment number. This suffix is ignored; the command deletes all segments.

**Example:**           SEGM:ADD  
 Create a new sweep segment no. 1 in channel no. 1 using default settings.  
 SEGM:DEL:ALL  
 Delete the created segment and all segments in the channel created before.

**Usage:**            Event

**Manual operation:** See "Add / Insert / Delete / Delete All" on page 245

### [SENSe<Ch>:]SEGMENT<Seg>:DELete[:DUMMy]

Deletes the specified (single) sweep segment. [SENSe<Ch>:]SEGMENT<Seg>:DELete:ALL deletes all segments in the channel.

**Suffix:**

<Ch>                    Channel number

<Seg>                   Sweep segment number

**Example:**           SEGM:ADD  
 Create a new sweep segment no. 1 in channel no. 1 using default settings.  
 SEGM:DEL  
 Delete the created segment.

**Manual operation:** See "Add / Insert / Delete / Delete All" on page 245

### [SENSe<Ch>:]SEGMENT<Seg>:FREQUency:CENTer? [SENSe<Ch>:]SEGMENT<Seg>:FREQUency:SPAN?

These commands return the center frequency and the span (width) of sweep segment no. <Seg>.

**Suffix:**

<Ch>                    Channel number

<Seg>                   Sweep segment number

**Example:**           SEGM:INS 1MHZ, 1.5MHZ, 111, -21DBM, 0.5S, 0, 10KHZ  
 Create a sweep segment with a sweep range between 1.0 MHz and 1.5 MHz.  
 SEGM:FREQ:CENT? SPAN?  
 Query the center frequency and span of the created segment.  
 The response is 1250000;500000.

**Usage:**            Query only

**Manual operation:** See "Table Columns" on page 245

**Note:** The frequency range of the sweep segment can be changed via [SENSe<Ch>:]SEGMENT<Seg>:FREQUency:START and [SENSe<Ch>:]SEGMENT<Seg>:FREQUency:STOP.

**[SENSe<Ch>:]SEGMENT<Seg>:FREQUENCY:START <StartFreq>**  
**[SENSe<Ch>:]SEGMENT<Seg>:FREQUENCY:STOP <StopFreq>**

These commands define the start and stop frequency of sweep segment no. <Seg>. The sweep segments must be within the frequency range of the R&S ZNC/ZND; see [Table 6-9](#).

**Suffix:**

<Ch> Channel number  
 <Seg> Sweep segment number

**Parameters:**

<StopFreq> Start or stop frequency of the sweep.  
 Increment: 0.1 kHz  
 Default unit: Hz

**Example:**

```
SEGM:INS 1MHZ, 1.5MHZ, 111, -21DBM, 0.5S, 0, 10KHZ
```

Create a sweep segment with a sweep range between 1.0 MHz and 1.5 MHz.

```
SEGM:FREQ:STAR?; STOP?
```

Query the start and stop frequency of the created segment. The response is 1000000;1500000.

**Manual operation:** See "[Table Columns](#)" on page 245

**Note:** If the start frequency entered is greater than the current stop frequency, the stop frequency is set to the start frequency plus the minimum frequency span of 1 Hz. If the stop frequency entered is smaller than the current start frequency, the start frequency is set to the stop frequency minus the minimum frequency span ([\[SENSe<Ch>:\]FREQUENCY:SPAN](#)).

**[SENSe<Ch>:]SEGMENT<Seg>:INSERT <StartFreq>, <StopFreq>, <Points>, <Power>, <SegmentTime>|<MeasDelay>, <Unused>, <MeasBandwidth>[, <LO>, <Selectivity>, <FreqSweepMode>]**

Adds a new sweep segment no. <Seg> with specific channel settings.

Entry of the first seven numeric parameters is mandatory; no default values are provided. All settings except <LO> can be changed for existing segments using other commands of the [\[SENSe<Ch>:\]SEGMENT<Seg>... subsystem](#).

**Note:** Use [\[SENSe<Ch>:\]SEGMENT<Seg>:ADD](#) to create a segment with default channel settings. Use [\[SENSe<Ch>:\]SEGMENT<Seg>:DEFine](#) to change or query all settings of an existing segment.

**Suffix:**

<Ch> Channel number

|                    |                                                                                                                                                                                                                                                                                                                                                                                                                                                                                                                                                                   |
|--------------------|-------------------------------------------------------------------------------------------------------------------------------------------------------------------------------------------------------------------------------------------------------------------------------------------------------------------------------------------------------------------------------------------------------------------------------------------------------------------------------------------------------------------------------------------------------------------|
| <Seg>              | <p>Sweep segment number. Segment numbers must be sequential. The specified segment number must be smaller or equal to the number of existing segments plus 1.</p> <p>If one or more sweep segments with segment numbers &lt;Seg&gt; or larger exist in the current channel, then all these existing segment numbers are incremented by 1 and the new segment is inserted as segment no. &lt;Seg&gt;.</p> <p>Note that &lt;Seg&gt; defaults to 1, so [SENSE&lt;Ch&gt;:]SEGMENT:INSERT inserts a new segment 1, shifting the existing segments one position up.</p> |
| <b>Parameters:</b> |                                                                                                                                                                                                                                                                                                                                                                                                                                                                                                                                                                   |
| <StartFreq>        | <p>Start frequency of the segment. See [SENSE&lt;Ch&gt;:]SEGMENT&lt;Seg&gt;:FREQUENCY:START.</p> <p>Default unit: Hz</p>                                                                                                                                                                                                                                                                                                                                                                                                                                          |
| <StopFreq>         | <p>Stop frequency of the segment; see [SENSE&lt;Ch&gt;:]SEGMENT&lt;Seg&gt;:FREQUENCY:STOP.</p> <p>Default unit: Hz</p>                                                                                                                                                                                                                                                                                                                                                                                                                                            |
| <Points>           | <p>Number of sweep points in the segment. See [SENSE&lt;Ch&gt;:]SEGMENT&lt;Seg&gt;:SWEPT:POINTS.</p>                                                                                                                                                                                                                                                                                                                                                                                                                                                              |
| <Power>            | <p>Internal source power in the segment. See [SENSE&lt;Ch&gt;:]SEGMENT&lt;Seg&gt;:POWER[:LEVEL].</p> <p>Default unit: dBm</p>                                                                                                                                                                                                                                                                                                                                                                                                                                     |
| <SegmentTime>      | <p>Duration of the sweep in the segment. See [SENSE&lt;Ch&gt;:]SEGMENT&lt;Seg&gt;:SWEPT:TIME. In the setting [SENSE&lt;Ch&gt;:]SEGMENT&lt;Seg&gt;:INSERT:SELECT DWELL, this parameter is replaced by &lt;MeasDelay&gt;.</p> <p>Range: Depending on other channel settings. AUTO activates automatic sweep time setting in the segment, which is equivalent to the minimum sweep time possible.</p> <p>Default unit: s</p>                                                                                                                                         |
| <MeasDelay>        | <p>Delay for each partial measurement in the segment. See [SENSE&lt;Ch&gt;:]SEGMENT&lt;Seg&gt;:SWEPT:DWELL. In the setting [SENSE&lt;Ch&gt;:]SEGMENT&lt;Seg&gt;:INSERT:SELECT SWTime, this parameter is replaced by &lt;SegmentTime&gt;.</p>                                                                                                                                                                                                                                                                                                                      |
| <Unused>           | <p>Ignored parameter (for compatibility with R&amp;S ZVR analyzers). Should be set to the default value 0.</p>                                                                                                                                                                                                                                                                                                                                                                                                                                                    |
| <MeasBandwidth>    | <p>Resolution bandwidth in the segment. See [SENSE&lt;Ch&gt;:]SEGMENT&lt;Seg&gt;:BWIDTH[:RESOLUTION].</p> <p>Default unit: Hz</p>                                                                                                                                                                                                                                                                                                                                                                                                                                 |

|                          |                                                                                                                                                                                                                                                                                                                     |
|--------------------------|---------------------------------------------------------------------------------------------------------------------------------------------------------------------------------------------------------------------------------------------------------------------------------------------------------------------|
| <LO>                     | POSitive   NEGative   AUTO<br>Position of the local oscillator frequency LO relative to the RF frequency. In remote control this parameter must be set when a sweep segment is created. See <a href="#">[SENSe&lt;Ch&gt;: ]FREQuency: SBANd</a> .                                                                   |
| <Selectivity>            | NORMal<br>Selectivity of the IF filter; must be set to NORMal.                                                                                                                                                                                                                                                      |
| <FreqSweepMode>          | STEPped<br>Frequency sweep mode; must be set to Stepped.                                                                                                                                                                                                                                                            |
| <b>Example:</b>          | <pre>SEGM:INS 1MHZ, 1.5MHZ, 111, -21DBM, 0.5S, 0, 10KHZ</pre> <p>Create a sweep segment with a sweep range between 1.0 MHz and 1.5 MHz.</p> <pre>SEGM2:ADD</pre> <p>Create a second sweep segment. The frequency range of the second segment will be between 1.5 MHz and the maximum frequency of the analyzer.</p> |
| <b>Manual operation:</b> | See <a href="#">"Add / Insert / Delete / Delete All"</a> on page 245                                                                                                                                                                                                                                                |

---

#### **[SENSe<Ch>:]SEGMent<Seg>:INSert:SElect <TimeRef>**

Defines whether the sweep time of a new segment, i.e. numeric parameter no. 5 of the command [\[SENSe<Ch>:\]SEGMent<Seg>:INSert](#), is entered as a segment sweep time ("Segment Time") or as a measurement delay ("Meas Delay").

**Suffix:**

|       |                      |
|-------|----------------------|
| <Ch>  | Channel number       |
| <Seg> | Sweep segment number |

**Parameters:**

|           |                                                                                      |
|-----------|--------------------------------------------------------------------------------------|
| <TimeRef> | SWTime   DWELI<br>SWTime - use segment sweep time.<br>DWELI - use measurement delay. |
| *RST:     | SWTime                                                                               |

|                 |                                                                                                                                                                                                                                                                                                                                                                           |
|-----------------|---------------------------------------------------------------------------------------------------------------------------------------------------------------------------------------------------------------------------------------------------------------------------------------------------------------------------------------------------------------------------|
| <b>Example:</b> | <pre>SEGM1:INS:SEL DWEL</pre> <p>Select the meas. delay to determine the sweep time in a new sweep segment no. 1.</p> <pre>SEGM1:INS 1MHZ, 1.5MHZ, 111, -21DBM, 0.01S, 0, 10KHZ</pre> <p>Create a sweep segment with a sweep range between 1.0 MHz and 1.5 MHz and a meas. delay of 10 ms.</p> <pre>SEGM1:SWE:TIME?</pre> <p>Query the sweep time in the new segment.</p> |
|-----------------|---------------------------------------------------------------------------------------------------------------------------------------------------------------------------------------------------------------------------------------------------------------------------------------------------------------------------------------------------------------------------|

**Manual operation:** See ["Table Columns"](#) on page 248



---

**[SENSe<Ch>:]SEGMent<Seg>:POWer[:LEVel] <IntSourcePow>**

Defines the power of the internal signal source in sweep segment no. <Seg>. At the same time, the command activates separate power control in all sweep segments (`[SENSe<Ch>:]SEGMent<Seg>:POWer[:LEVel]:CONTRol`).

**Suffix:**

<Ch> Channel number  
 <Seg> Sweep segment number

**Parameters:**

<IntSourcePow> Internal source power  
 Range: -300 dBm to +200 dBm. The usable power range is frequency-dependent; refer to the data sheet.  
 \*RST: -10 dBm  
 Default unit: dBm

**Example:**

```
SEGM:ADD
Create a new sweep segment no. 1 in channel no. 1 using
default settings and thus -10 dBm internal source power.
SEGM:POW -20
Decrease the power to -20 dBm.
```

**Manual operation:** See "[Table Columns](#)" on page 248

---

**[SENSe<Ch>:]SEGMent<Seg>:POWer:GAINcontrol <ReceiverName>, <Mode>**  
**[SENSe<Ch>:]SEGMent<Seg>:POWer:GAINcontrol? <ReceiverName>**

Defines port- and segment-specific IF gain settings.

These settings apply if and only if "Segmented AGC" is enabled (see `[SENSe<Ch>:]SEGMent<Seg>:POWer:GAINcontrol:CONTRol`).

**Note:**

- This command is not available for the R&S ZND.
- Without the [Extended Power Range](#) option only the gain of the measurement receivers (the b-waves) can be statically set (to LNoise or LDISTortion); the reference receiver always uses automatic gain control (AUTO). With the option available, also the gain of the reference receivers (the a-waves) can be set statically.
- Disable "Segmented AGC" and use `[SENSe<Ch>:]POWer:GAINcontrol` instead, if no distinction between different sweep segments shall be made.

**Suffix:**

<Ch> Channel number  
 <Seg> Sweep segment number

**Parameters:**

<Mode> LNOise | LDISTortion | AUTO  
 AUTO – automatic/adaptive gain control (AGC) according to the RF input level.  
 LNOise – static, large IF gain, for low input levels.  
 LDISTortion – static, small IF gain, for high input levels.

**Parameters for setting and query:**

<ReceiverName> String parameter defining the wave(s) followed by the drive port; see examples below and [Table 6-4](#).

**Example:**

```
*RST; :SENSe:POWer:GAINcontrol:GLOBal MANual
Activate independent AGC settings for each drive port.
SENSe:SEGMent1:ADD; :SENSe:SWEep:TYPE SEGMent
Create a new sweep segment no. 1 and activate segmented sweep type.
SENSe:SEGMent1:POWer:GAINcontrol:CONTRol OFF
Enable segmented AGC.
SENSe:SEGMent1:POWer:GAINcontrol 'B2D1', LNO
Set the ACG for the received wave b2 (port 2) in sweep segment no. 1 to "Low Noise". The setting applies while port 1 is the drive port.
SENSe:SEGMent1:POWer:GAINcontrol 'A2B2B3D2', LNO
Set the ACG for the waves a2, b2, and b3 in sweep segment no. 1 to "Low Noise". The setting applies while port 2 is the drive port.
SENSe:SEGMent1:POWer:GAINcontrol? 'B1D2'
Query the ACG setting for the wave b1 in sweep segment no. 1 while port 2 is the drive port. The response is 1, LDIS (default setting).
```

**Manual operation:** See "[Manual Config...](#)" on page 303

---

**[SENSe<Ch>:]SEGMent<Seg>:POWer:GAINcontrol:CONTRol <arg0>**

Defines whether common or independent gain control settings shall be used for the individual sweep segments.

**Note:**

This command is not available for the R&S ZND.

**Suffix:**

<Ch> Channel number  
 <Seg> Sweep segment number. This suffix is ignored; the setting controls the whole segmented sweep.

**Parameters:**

<arg0> ON – use independent AGC settings, to be defined via `[SENSE<Ch>:]SEGMENT<Seg>:POWER:GAINcontrol`.  
 OFF – reset the AGC in all sweep segments to the AGC for unsegmented sweeps, defined via `[SENSE<Ch>:]POWER:GAINcontrol` or `[SENSE<Ch>:]POWER:GAINcontrol:GLOBAL`. ON will not restore the previous values.  
 The parameter is automatically switched to ON when an AGC is entered using `[SENSE<Ch>:]SEGMENT<Seg>:POWER:GAINcontrol`.

\*RST: OFF

**Example:** See `[SENSE<Ch>:]SEGMENT<Seg>:POWER:GAINcontrol`

**Manual operation:** See "Segmented AGC" on page 304

**[SENSE<Ch>:]SEGMENT<Seg>:POWER[:LEVEL]:CONTROL <Boolean>**

Selects common or independent internal source "Power" settings for the sweep segments.

**Suffix:**

<Ch> Channel number

<Seg> Sweep segment number. This suffix is ignored; the setting controls the whole segmented sweep.

**Parameters:**

<Boolean> ON – use independent power settings, to be defined via `[SENSE<Ch>:]SEGMENT<Seg>:POWER[:LEVEL]`.  
 OFF – reset the power in all sweep segments to the power for unsegmented sweeps, defined via `SOURCE<Ch>:POWER<PhyPt>[:LEVEL][:IMMEDIATE][:AMPLITUDE]`. ON will not restore the previous values.  
 The parameter is automatically switched to ON when a segment power is entered using `[SENSE<Ch>:]SEGMENT<Seg>:POWER[:LEVEL]`.

\*RST: OFF

**Example:**

```
SEGM:ADD
Create a new sweep segment no. 1 in channel no. 1 using
default settings and thus -10 dBm internal source power.
SEGM:POW -20
Decrease the power to -20 dBm.
SEGM:POW:CONT OFF
Couple the powers in all segments and reset the power in seg-
ment no. 1 to the initial value.
```

**Manual operation:** See "Table Columns" on page 248

**[SENSe<Ch>:]SEGMENT<Seg>[:STATe] <Boolean>**

Activates or deactivates the sweep segment <Seg>. Sweep points belonging to inactive segments only are not measured.

**Suffix:**

<Ch> Channel number  
 <Seg> Sweep segment number

**Parameters:**

<Boolean> ON | OFF - activates or deactivates the measurement in sweep segment <Seg>.  
 \*RST: ON

**Example:**

```
SEGM:ADD
Create a new sweep segment no. 1 in channel no. 1 using
default settings.
SEGM OFF
Disable the measurement in the created sweep segment.
```

**Manual operation:** See "Table Columns" on page 245

**[SENSe<Ch>:]SEGMENT<Seg>:SWEep:DWELI <MeasDelay>**

Defines the delay time for each partial measurement in sweep segment no. <Seg> ("Meas. Delay"). If coupling of the segments is switched on ( [SENSe<Ch>:]SEGMENT<Seg>:SWEep:DWELI:CONTROLON), the delay is valid for all sweep segments in the current channel.

**Suffix:**

<Ch> Channel number  
 <Seg> Sweep segment number

**Parameters:**

<MeasDelay> Measurement delay before each partial measurement. Changing the delay leaves the number of points unchanged but has an impact on the duration of the sweep ( [SENSe<Ch>:]SEGMENT<Seg>:SWEep:TIME).  
 Range: 0 s to 2500 s  
 \*RST: 0 s  
 Default unit: s

**Example:**

```
SEGM:ADD
Create a new sweep segment no. 1 in channel no. 1 using
default settings.
SEGM:SWE:DWEL 1 MS
Set the meas. delay in segment no. 1 to 1 ms.
SEGM:DEF? Response:
300000,8000000000,51,-300,0.056559,0,10000,POS,
NORM
Query the channel parameters for sweep segment 1. The
response value for the segment sweep time (olive) implicitly con-
tains the defined meas. delay.
```

**Manual operation:** See "Table Columns" on page 248

### [SENSe<Ch>:]SEGMent<Seg>:SWEep:DWELI:CONTRol <Boolean>

Selects common or independent "Meas. Delay" settings for the sweep segments.

**Suffix:**

<Ch> Channel number.

<Seg> Sweep segment number. This suffix is ignored; the command controls the whole segmented sweep.

**Parameters:**

<Boolean> ON – use independent delay settings, to be defined via [SENSe<Ch>:]SEGMent<Seg>:SWEep:DWELI.  
 OFF – reset the delay in all sweep segments to the delay for unsegmented sweeps, defined via [SENSe<Ch>:]SWEep:DWELI.  
 The parameter is automatically switched to ON when a meas. delay time is entered using [SENSe<Ch>:]SEGMent<Seg>:SWEep:DWELI.  
 \*RST: OFF

**Example:**

```
SEGM:ADD
Create a new sweep segment no. 1 in channel no. 1 using
default settings and thus 0 s meas. delay.
SEGM:SWE:DWELI 0.1
Increase the meas. delay to 0.1 s.
SEGM:SWE:DWELI:CONT OFF
Couple the meas. delay in all segments and reset the delay in
segment no. 1 to the initial value of 0 s.
```

**Manual operation:** See "Table Columns" on page 248

### [SENSe<Ch>:]SEGMent<Seg>:SWEep:POINts <SegPoint>

Defines the total number of measurement points in sweep segment no. <Seg>.

**Suffix:**

<Ch> Channel number

|                          |                                                                                                                                                                                |
|--------------------------|--------------------------------------------------------------------------------------------------------------------------------------------------------------------------------|
| <Seg>                    | Sweep segment number                                                                                                                                                           |
| <b>Parameters:</b>       |                                                                                                                                                                                |
| <SegPoint>               | Number of points in the segment                                                                                                                                                |
| Range:                   | 1 to 100001. 1 is allowed if start and stop frequencies are equal.                                                                                                             |
| *RST:                    | 51                                                                                                                                                                             |
| <b>Example:</b>          | <pre>SEGM:ADD</pre> <p>Create a new sweep segment no. 1 in channel no. 1 using default settings.</p> <pre>SEGM:SWE:POIN 401</pre> <p>Increase the number of points to 401.</p> |
| <b>Manual operation:</b> | See "Table Columns" on page 245                                                                                                                                                |

### [SENSe<Ch>:]SEGMENT<Seg>:SWEep:TIME <SegSweepTime>

Sets the duration of the sweep in sweep segment no. <Seg> ("Segment Time"). At the same time, the command activates separate sweep time setting in all sweep segments ([SENSe<Ch>:]SEGMENT<Seg>:SWEep:TIME:CONTROLON).

#### Suffix:

|       |                      |
|-------|----------------------|
| <Ch>  | Channel number       |
| <Seg> | Sweep segment number |

#### Parameters:

|                |                                                                                                                                                                                                                                                                                                                                                                                                                                                                                                                                                                                                                                                                                             |
|----------------|---------------------------------------------------------------------------------------------------------------------------------------------------------------------------------------------------------------------------------------------------------------------------------------------------------------------------------------------------------------------------------------------------------------------------------------------------------------------------------------------------------------------------------------------------------------------------------------------------------------------------------------------------------------------------------------------|
| <SegSweepTime> | <p>Segment time. The minimum segment time depends on the other channel settings, in particular on the number of points ([SENSe&lt;Ch&gt;:]SEGMENT&lt;Seg&gt;:SWEep:POINTs), the IF bandwidth ([SENSe&lt;Ch&gt;:]SEGMENT&lt;Seg&gt;:BWIDth[:RESolution]) and the delay for each partial measurement ([SENSe&lt;Ch&gt;:]SEGMENT&lt;Seg&gt;:SWEep:DWELL). The maximum is 1000 s. Changing the duration leaves the number of points unchanged but directly affects the delay.</p> <p>Range: Minimum value to 1000 s</p> <p>*RST: Minimum value, depending on the channel settings. This default value corresponds to automatic sweep time setting in manual control.</p> <p>Default unit: s</p> |
|----------------|---------------------------------------------------------------------------------------------------------------------------------------------------------------------------------------------------------------------------------------------------------------------------------------------------------------------------------------------------------------------------------------------------------------------------------------------------------------------------------------------------------------------------------------------------------------------------------------------------------------------------------------------------------------------------------------------|

#### Example:

```
SEGM:ADD
```

Create a new sweep segment no. 1 in channel no. 1.

```
SEGM:SWE:TIME 0.1
```

Increase the segment sweep time to 0.1 s.

```
SEGM:SWE:TIME:SUM?
```

Query the total duration of the segmented sweep. The response is 0.1, because there is only one sweep segment.

**Manual operation:** See "Table Columns" on page 248

**[SENSe<Ch>:]SEGMENT<Seg>:SWEep:TIME:CONTROL <Boolean>**

Selects common or independent "Segment Sweep Time" settings for the sweep segments.

**Suffix:**

<Ch> Channel number

<Seg> Sweep segment number. This suffix is ignored; the command controls the whole segmented sweep.

**Parameters:**

<Boolean> ON – use independent segment sweep time settings, to be defined via [SENSe<Ch>:]SEGMENT<Seg>:SWEep:TIME.  
 OFF – reset the segment sweep time in all sweep segments to the segment sweep time for unsegmented sweeps, defined via [SENSe<Ch>:]SWEep:TIME. ON will not restore the previous values.  
 The parameter is automatically switched to ON when a segment sweep time is entered using [SENSe<Ch>:]SEGMENT<Seg>:SWEep:TIME or if the channel settings in a sweep segment require a sweep time larger than the unsegmented sweep time.  
 \*RST: OFF

**Example:**

```
SEGM:ADD
Create a new sweep segment no. 1 in channel no. 1.
SEGM:SWE:TIME 0.1
Increase the segment sweep time to 0.1 s.
SEGM:SWE:TIME:CONT OFF
Couple the sweep times in all segments and reset the sweep
time in segment no. 1 to the initial value.
```

**Manual operation:** See "Table Columns" on page 248

**[SENSe<Ch>:]SEGMENT<Seg>:SWEep:TIME:SUM?**

Returns the total duration of the segmented sweep, calculated as the sum of the sweep times of the individual segments ([SENSe<Ch>:]SEGMENT<Seg>:SWEep:TIME).

**Suffix:**

<Ch> Channel number.

<Seg> Sweep segment number. This suffix is ignored; the command returns the sum of all segments.

**Example:** See [SENSe<Ch>:]SEGMENT<Seg>:SWEep:TIME

**Usage:** Query only

**Manual operation:** See "Table Columns" on page 248

### 6.3.15.15 [SENSe:]SWEep...

The [SENSe:]SWEep... commands provide general settings to control the sweep. Most of the settings have an impact on the sweep time.

|                                      |     |
|--------------------------------------|-----|
| [SENSe<Ch>:]SWEep:COUNT.....         | 672 |
| [SENSe:]SWEep:COUNT:ALL.....         | 672 |
| [SENSe<Ch>:]SWEep:DETECTOR:TIME..... | 673 |
| [SENSe<Ch>:]SWEep:DWELI.....         | 673 |
| [SENSe<Ch>:]SWEep:DWELI:IPOINT.....  | 674 |
| [SENSe<Ch>:]SWEep:POINTS.....        | 674 |
| [SENSe<Chn>:]SWEep:SRCPort.....      | 675 |
| [SENSe<Ch>:]SWEep:STEP.....          | 675 |
| [SENSe<Ch>:]SWEep:TIME.....          | 676 |
| [SENSe<Ch>:]SWEep:TIME:AUTO.....     | 677 |
| [SENSe<Ch>:]SWEep:TYPE.....          | 677 |

---

#### [SENSe<Ch>:]SWEep:COUNT <Sweep>

Defines the number of sweeps to be measured in single sweep mode (INITiate<Ch>:CONTinuousOFF) and in channel no. <Ch>. Use [SENSe:]SWEep:COUNT:ALL to define the sweep count for all channels.

##### Suffix:

<Ch> Channel number

##### Parameters:

<Sweep> Number of consecutive sweeps to be measured.  
 Range: 1 to 100000  
 \*RST: 1

**Example:** See CALCulate<Chn>:DATA:NSWep:FIRSt?

**Manual operation:** See "Sweeps" on page 250

---

#### [SENSe:]SWEep:COUNT:ALL <Sweep>

Defines the number of sweeps to be measured in single sweep mode (INITiate<Ch>:CONTinuousOFF). The setting is applied to all channels. Use [SENSe<Ch>:]SWEep:COUNT to define the sweep count for a single channel.

##### Setting parameters:

<Sweep> Number of consecutive sweeps to be measured.  
 Range: 1 to 100000  
 \*RST: 1

**Example:** See Chapter 7.2.4, "Data Handling", on page 788.

**Usage:** Setting only

**Manual operation:** See "Sweeps" on page 250



**[SENSe<Ch>:]SWEep:DETECTOR:TIME <DetectorTime>**

Defines the detector observation time ratios and wave quantities if an "AVG Real Imag" or an "AVG Mag Phase" detector is active. The detector is selected together with the measured quantity (`CALCulate<Ch>:PARAmeter:MEASure` or `CALCulate<Ch>:PARAmeter:SDEFine`).

**Suffix:**

<Ch> Channel number

**Parameters:**

<DetectorTime> Detector time  
 Range: 0 s to 3456000 s  
 \*RST: 0.01 s  
 Default unit: s

**Example:**

```
*RST; :CALC:PAR:MEAS 'TRC1', 'a1D1RMS'
```

Select the wave quantity  $a_1$  for the default trace and activate the RMS detector.

```
SWE:DET:TIME 1
```

Specify an observation time of 1 s at each sweep point.

**Manual operation:** See "[Detector](#)" on page 139

**[SENSe<Ch>:]SWEep:DWELI <MeasDelay>**

Defines the "Meas. Delay" before each partial measurement or the first partial measurement (depending on whether "All Partial Meas'ments" or "First Partial Meas'ment" is selected). Setting a delay disables the automatic calculation of the (minimum) sweep time; see `[SENSe<Ch>:]SWEep:TIME:AUTO`.

**Suffix:**

<Ch> Channel number

**Parameters:**

<MeasDelay> Measurement delay before each partial measurement. Changing the delay leaves the number of points unchanged but has an impact on the duration of the sweep (`[SENSe<Ch>:]SWEep:TIME`).  
 Range: 0 s to 13680 s  
 \*RST: 0 s  
 Default unit: s

**Example:**                    \*RST  
 Reset the instrument, activating a frequency sweep with the S-parameter  $S_{21}$  as a measurement result for channel and trace no. 1.  
 SWEep:TIME?  
 Query total sweep time.  
 SWEep:DWEL 1  
 SWEep:DWEL:IPoint ALL  
 Set a delay of 1 s for each partial measurement.  
 SWE:TIME?  
 Query total sweep time. The time is extended by the delay times the total number of sweep points (one partial measurement per sweep point required).

**Manual operation:**    See "[Meas Delay](#)" on page 238

#### [SENSe<Ch>:]SWEep:DWEL:IPoint <InsertionPoints>

Defines whether the measurement delay (previously defined via [SENSe<Ch>:]SWEep:DWEL1) is inserted before all partial measurements or before the first partial measurement only.

**Suffix:**

<Ch>                    Channel number

**Parameters:**

<InsertionPoints>    ALL | FIRSt  
 Insertion before all or before the first partial measurement  
 \*RST:                ALL

**Example:**                See [SENSe<Ch>:]SWEep:DWEL1

**Manual operation:**    See "[All Partial Meas'ments / First Partial Meas'ment](#)" on page 238

#### [SENSe<Ch>:]SWEep:POINTs <SweepPoint>

Defines the total number of measurement points per sweep ("Number of Points").

Values between 1 and 5,001 can be set.

**Suffix:**

<Ch>                    Channel number 1

**Parameters:**

<SweepPoint>        Number of points per sweep  
 Range:                see above  
 \*RST:                201

- Example:**                    \*RST  
Reset the instrument, activating a frequency sweep with 201 sweep points.  
SWE:TIME?  
Query total sweep time.  
SWE:POIN 2010  
Multiply the (default) number of points by 10.  
SWE:TIME?  
Query total sweep time again. The analyzer estimates a sweep time that is also multiplied by 10.
- Manual operation:** See ["Start / Stop / Center / Span Frequency \(Power / Time\)"](#) on page 229

**[SENSe<Chn>:]SWEep:SRCPort <Port>**

Sets/gets the source port for the stimulus signal. The setting acts on the active trace. The effect of the drive port selection depends on the measurement parameter associated to the active trace:

- If an S-parameter  $S_{\text{out}<in>}$  is measured, the second port number index <in> (input port of the DUT = drive port of the analyzer) is set equal to the selected drive port: Drive port selection affects the measured quantity.
- If a wave quantity or a ratio is measured, the drive port is independent of the measured quantity:

**Suffix:**

<Chn>                    Channel number used to identify the active trace.

**Parameters:**

<Port>                    Logical port number

\*RST:                    1

**Example:**

CALC4:PAR:SDEF "Ch4Tr1", "A1"

Create channel 4 and a trace named "Ch4Tr1" to measure the wave quantity  $a_1$ . The trace automatically becomes the active trace.

SENS4:SWE:SRCP 2

Select drive port 2 for the active trace.

CALC4:PAR:MEAS? "Ch4Tr1"

Query the measurement result for "Ch4Tr1". The response is 'A1D2SAM'.

**[SENSe<Ch>:]SWEep:STEP <StepSize>**

Sets the distance between two consecutive sweep points.

**Note:** This setting is valid for sweep types with equidistant sweep points only. It does not apply to logarithmic and segmented sweeps.

**Suffix:**

<Ch>                    Channel number

**Parameters:**

<StepSize> Stimulus step size. The minimum step size is equal to the sweep span divided by the maximum number of points (`[SENSe<Ch>: ]SWEep:POINts`) minus one, the maximum step size is equal to the sweep span (`[SENSe<Ch>: ]FREQuency:SPAN`). See also description of manual control and program example below.

Range: Depending on the other channel settings; see above.

\*RST: Depending on the analyzer model. The default step size is equal to the default sweep span of the analyzer divided by the default number of points minus one.

Default unit: Hz

**Example:**

```
*RST; :SWE:STEP?
```

Query the default step size. For a 8.5 GHz analyzer, the response is `42499500`.  $42499500 \text{ Hz} = (8.5 \text{ GHz} - 100 \text{ kHz}) / 200$ .

```
SWE:STEP UP
```

Increase the step size.

```
FREQ:STOP?; :SWE:POIN?
```

Query the stop frequency of the sweep and the number of points. Increasing the step size has changed both values.

**Manual operation:** See "[Freq Step Size](#)" on page 237

**[SENSe<Ch>:]SWEep:TIME <SweepDuration>**

Sets the duration of the sweep ("Sweep Time"). Setting a sweep time disables the automatic calculation of the (minimum) sweep time; see `[SENSe<Ch>: ]SWEep:TIME:AUTO`.

**Note:** The sweep time is ignored for the sweep types "Time" and "CW Mode" (`[SENSe<Ch>: ]SWEep:TYPE`).

**Suffix:**

<Ch> Channel number

**Parameters:**

<SweepDuration> Sweep time. The minimum sweep time depends on the other channel settings, in particular on the number of points (`[SENSe<Ch>: ]SWEep:POINts`), the IF bandwidth (`[SENSe<Ch>: ]BWIDth[:RESolution]`) and the measurement delay for each partial measurement (`[SENSe<Ch>: ]SWEep:DWELL`). Changing the duration leaves the number of points unchanged but directly affects the delay.

Range: Minimum sweep time to 100000 s.

\*RST: Minimum sweep time, depending on the channel settings.

Default unit: s

**Example:**

```
SWE:TIME 1
Set a total sweep time of 1 s.
SWE:DWEL?
Query the delay for each partial measurement.
SWE:TIME 2
Increase the total sweep time to 2 s.
SWE:DWEL?
Query the meas. delay for each partial measurement again. The
delay is increased by 1 s divided by the total number of partial
measurements per sweep.
```

**Manual operation:** See "[Start / Stop / Center / Span Frequency \(Power / Time\)](#)" on page 229

---

#### [SENSe<Ch>:]SWEep:TIME:AUTO <Boolean>

When enabled, the (minimum) sweep time is calculated internally using the other channel settings and zero delay ([SENSe<Ch>:]SWEep:DWEL1).

**Note:** The automatically calculated sweep duration is ignored for the sweep types "Time" and "CW Mode" ([SENSe<Ch>:]SWEep:TYPE).

#### Suffix:

<Ch> Channel number

#### Parameters:

<Boolean> ON | OFF - turn the automatic calculation of the sweep time on or off.  
 OFF is also set if the sweep duration or delay is set explicitly using [SENSe<Ch>:]SWEep:TIME or [SENSe<Ch>:]SWEep:DWEL1.

\*RST: ON

#### Example:

```
SWE:TIME 1
Set a total sweep time of 1 s.
SWE:TIME:AUTO?
A query returns the value 1.
```

**Manual operation:** See "[Sweep Time / Auto](#)" on page 238

---

#### [SENSe<Ch>:]SWEep:TYPE <Format>

Selects the sweep type, i.e. the sweep variable (frequency/power/time) and the position of the sweep points across the sweep range.

#### Suffix:

<Ch> Channel number.

**Parameters:**

&lt;Format&gt;

LINear | LOGarithmic | POWer | CW | POINT | SEGMENT

LINear - linear frequency sweep at constant source power (SOURCE<Ch>:POWER<PhyPt>[:LEVEL][:IMMEDIATE][:AMPLITUDE]). The stimulus frequency ([SENSE<Ch>:]FREQUENCY:...) is swept in equidistant steps over the frequency range. In a Cartesian diagram, the x-axis is a linear frequency axis.

LOGarithmic - logarithmic frequency sweep. The frequency is swept in equidistant steps on a logarithmic scale. In a Cartesian diagram, the x-axis is a logarithmic frequency axis.

SEGMENT - segmented frequency sweep. The sweep range is composed of several continuous frequency ranges or single frequency points defined by means of the commands in the [SENSE<Ch>:]SEGMENT<Seg>... subsystem.

POWer - power sweep. The measurement is performed at constant frequency (SOURCE<Ch>:FREQUENCY<PhyPt>:FIXED) but with variable generator power that is swept in linear, equidistant steps over a continuous range

(SOURCE<Ch>:POWER<PhyPt>:START, SOURCE<Ch>:POWER<PhyPt>:STOP). In a Cartesian diagram, the x-axis is a dB-linear power axis.

CW - time sweep. The measurement is performed at constant frequency (SOURCE<Ch>:FREQUENCY<PhyPt>:FIXED) and source power (SOURCE<Ch>:POWER<PhyPt>[:LEVEL][:IMMEDIATE][:AMPLITUDE]) and repeated over a specified period of time at constant time intervals.

POINT - CW mode sweep, time sweep triggered according to the current trigger settings.

\*RST: LINear

**Example:**

\*RST

Reset the analyzer, activating a linear frequency sweep.

SWE:TYPE LOG

Change to a logarithmic frequency sweep, resetting the stimulus values of the sweep points.

**Manual operation:** See "Lin Freq" on page 239

## 6.3.16 SOURce Commands

The SOURCE... commands affect the source settings of the R&S ZNC/ZND.

### 6.3.16.1 SOURce:FREQUENCY...

The SOURCE:FREQUENCY... commands configure the sources for frequency conversion measurements and control the frequency and power of the internal signal source.

|                                                                       |     |
|-----------------------------------------------------------------------|-----|
| SOURce<Ch>:FREQuency<PhyPt>:CONVersion:ARBitrary:EFRequency<Gen>..... | 679 |
| SOURce<Ch>:FREQuency<PhyPt>:CONVersion:ARBitrary:IFRequency.....      | 680 |
| SOURce<Ch>:FREQuency<PhyPt>[:CW].....                                 | 682 |
| SOURce<Ch>:FREQuency<PhyPt>:FIXed.....                                | 682 |

---

**SOURce<Ch>:FREQuency<PhyPt>:CONVersion:ARBitrary:EFRequency<Gen>**  
 <Boolean>, <Numerator>, <Denominator>, <Offset>, <SweepType>

Defines an external generator frequency for frequency-converting measurements. The external generator frequency is either a range (for frequency sweeps) or a CW frequency (for power, time and CW Mode sweeps).

**Suffix:**

|         |                                                                                                         |
|---------|---------------------------------------------------------------------------------------------------------|
| <Ch>    | Channel number                                                                                          |
| <PhyPt> | Test port number of the analyzer. This suffix is ignored because the generator is referenced via <Gen>. |
| <Gen>   | Generator number                                                                                        |

**Parameters:**

|               |                                                                                                                                                                                                                                                                                                                                                                                                                                                                                                                                                                                                                                                                                                                                                                     |
|---------------|---------------------------------------------------------------------------------------------------------------------------------------------------------------------------------------------------------------------------------------------------------------------------------------------------------------------------------------------------------------------------------------------------------------------------------------------------------------------------------------------------------------------------------------------------------------------------------------------------------------------------------------------------------------------------------------------------------------------------------------------------------------------|
| <Boolean>     | Switch the generator on or off.                                                                                                                                                                                                                                                                                                                                                                                                                                                                                                                                                                                                                                                                                                                                     |
| <Numerator>   | Parameters of the frequency formula. The source frequency $f_s$ is calculated according to $f_s = \text{<Numerator>/<Denominator> * } f_b + \text{<Offset>}$ where $f_b$ represents the channel base frequency (parameter SWEEP). For parameters CW or FIXed, $f_b = 0$ .<br><b>Note:</b> The <Offset> parameter also includes the "Offset Ratio" in manual control.<br>Range: The converted frequency or frequency range must be within the external generator's frequency range. In addition the <Numerator> values are rounded to positive or negative integer numbers.<br>*RST: The default frequency/frequency range corresponds to the sweep range or CW frequency of the analyzer, i.e. <Numerator> = <Denominator> = 1, <Offset> = 0 Hz.<br>Default unit: 1 |
| <Denominator> | See above, <Numerator><br>Range: The converted frequency or frequency range must be within the external generator's frequency range. In addition the <Denominator> values are rounded to positive integer numbers; zero is not allowed.<br>*RST: 1<br>Default unit: 1                                                                                                                                                                                                                                                                                                                                                                                                                                                                                               |

<Offset> See above, <Numerator>  
 Range: The converted frequency or frequency range must be within the external generator's frequency range. In addition the <Offset> values are rounded to (positive or negative) multiples of 1 Hz.  
 \*RST: 0  
 Default unit: Hz

<SweepType> CW | FIXed | SWEep  
 SWEep - the full formula is applied. For frequency sweeps, the command defines a sweep range.  
 CW | FIXed - the reduced formula with  $f_b = 0$  is applied; the command defines a fixed frequency.  
 \*RST: SWEep

**Example:**

```
*RST; FREQ:STAR 1E+9; STOP 1.1E+9
```

Reset the analyzer (activating a frequency sweep) and set the sweep range between 1 GHz and 1.1 GHz.

```
SYST:COMM:RDEV:GEN1:DEF 'Ext. Gen. 1', 'SME02', 'gpib0', '21'
```

Configure an R&S SME02 generator as external generator no. 1, assigning the name "Ext. Gen. 1" and a GPIB address 21.

```
SOUR:FREQ:CONV:ARB:EFR ON, 1, 4, 1E+9, SWE
```

Switch the generator on and convert the generator frequency to the range between 1.25 GHz and 1.275 GHz.

---

**SOURce<Ch>:FREQuency<PhyPt>:CONVersion:ARBItrary:IFRequency**  
 <Numerator>, <Denominator>, <Offset>, <SweepType>

Defines the port-specific frequency for frequency-converting measurements. The port frequency is either a range (for frequency sweeps) or a CW frequency (for power, time and "CW Mode" sweeps).

**Note:** The frequency formula is applied even if the analyzer returns an error message, because the frequency is outside the allowed range.

**Suffix:**

<Ch> Channel number

<PhyPt> Test port number of the analyzer



**Parameters:**

|               |                                                                                                                                                                                                                                                                                                                                                                                                                                                                                                                                                                                                                                                                                                                                                                                                                                                                                                                                                                                        |
|---------------|----------------------------------------------------------------------------------------------------------------------------------------------------------------------------------------------------------------------------------------------------------------------------------------------------------------------------------------------------------------------------------------------------------------------------------------------------------------------------------------------------------------------------------------------------------------------------------------------------------------------------------------------------------------------------------------------------------------------------------------------------------------------------------------------------------------------------------------------------------------------------------------------------------------------------------------------------------------------------------------|
| <Numerator>   | <p>Parameters of the frequency formula. The port frequency <math>f_p</math> is calculated according to <math>f_p = \frac{\text{&lt;Numerator&gt;}}{\text{&lt;Denominator&gt;}} * f_b + \text{&lt;Offset&gt;}</math> where <math>f_b</math> represents the channel base frequency (parameter <code>SWEep</code>). For parameters <code>CW</code> or <code>FIXed</code>, <math>f_b = 0</math>.</p> <p><b>Note:</b> The &lt;Offset&gt; parameter also includes the "Offset Ratio" in manual control.</p> <p>Range: The converted frequency or frequency range must be within the analyzer's frequency range, depending on the instrument model. In addition the &lt;Numerator&gt; values are rounded to positive or negative integer numbers; zero is not allowed.</p> <p>*RST: The default frequency/frequency range corresponds to the sweep range or CW frequency of the analyzer, i.e. &lt;Numerator&gt; = &lt;Denominator&gt; = 1, &lt;Offset&gt; = 0 Hz.</p> <p>Default unit: 1</p> |
| <Denominator> | <p>See above, &lt;Numerator&gt;</p> <p>Range: The converted frequency or frequency range must be within the analyzer's frequency range, depending on the instrument model. In addition the &lt;Denominator&gt; values are rounded to positive integer numbers; zero is not allowed.</p> <p>*RST: 1</p> <p>Default unit: 1</p>                                                                                                                                                                                                                                                                                                                                                                                                                                                                                                                                                                                                                                                          |
| <Offset>      | <p>See above, &lt;Numerator&gt;</p> <p>Range: The converted frequency or frequency range must be within the analyzer's frequency range, depending on the instrument model. In addition the &lt;Offset&gt; values are rounded to (positive or negative) multiples of 1 Hz.</p> <p>*RST: 0</p> <p>Default unit: Hz</p>                                                                                                                                                                                                                                                                                                                                                                                                                                                                                                                                                                                                                                                                   |
| <SweepType>   | <p>CW   FIXed   SWEep</p> <p>SWEep - the full formula is applied. For frequency sweeps, the command defines a sweep range.</p> <p>CW   FIXed - the reduced formula with <math>f_b = 0</math> is applied; the command defines a fixed frequency.</p> <p>*RST: SWEep</p>                                                                                                                                                                                                                                                                                                                                                                                                                                                                                                                                                                                                                                                                                                                 |

**Example:**                   \*RST; FREQ:STAR 1E+9; STOP 1.1E+9  
Reset the analyzer (activating a frequency sweep) and set the sweep range between 1 GHz and 1.1 GHz.  
SOUR:FREQ2:CONV:ARB:IFR 2, 1, 1E+9, SWE  
Convert the source frequency at test port no. 2 to the range between 3 GHz and 3.2 GHz.  
SENSe:FREQuency:CONVersion:GAIN:LMCorrection ON  
Enable the load match correction for all conversion gains.  
SENSe:FREQuency:CONVersion?  
Query the measurement mode. The response is ARB, because the port frequency definition also activates the arbitrary mode.  
SENSe:FREQuency:CONVersion FUND  
De-activate the arbitrary mode, cancel the port frequency definition.

---

**SOURce<Ch>:FREQuency<PhyPt>[:CW]** <FixedFreq>

**SOURce<Ch>:FREQuency<PhyPt>:FIXed** <FixedFreq>

Defines the fixed (Continuous Wave, CW) frequency for all sweep types operating at fixed frequency (power sweep, time sweep, CW mode sweep). The two command forms `SOURce<Ch>:FREQuency<PhyPt>:CW` and `SOURce<Ch>:FREQuency<PhyPt>:FIXed` are equivalent.

The frequency range is listed in [Table 6-9](#).

**Note:** `SOURce<Ch>:FREQuency<PhyPt>[:CW] | :FIXed` is equivalent to `[SENSe<Ch>:]FREQuency[:CW] | :FIXed`. Source and receiver frequency are always equal; the four commands overwrite each other.

**Suffix:**

<Ch>                           Channel number

<PhyPt>                      Test port number of the analyzer. This suffix is ignored because the selected frequency applies to all source ports in the active channel.

**Parameters:**

<FixedFreq>                 Fixed stimulus and analyzer frequency.

Increment: 0.1 kHz

\*RST: 1 GHz

Default unit: Hz

**Example:**

FUNC "XPOW:POW:A1"

Activate a power sweep and select the wave quantity  $a_1$  as measured parameter for channel and trace no. 1.

SOUR:FREQ: CW 100 MHz

Set the CW frequency to 100 MHz.

**Manual operation:** See "[CW Frequency](#)" on page 230

### 6.3.16.2 SOURce:LPORt...

The `SOURce:LPORt...` commands define the logical port configuration (balanced ports, renumbered single-ended ports).

|                                                              |     |
|--------------------------------------------------------------|-----|
| <code>SOURce&lt;Ch&gt;:LPORt&lt;LogPt&gt;</code> .....       | 683 |
| <code>SOURce&lt;Ch&gt;:LPORt&lt;LogPt&gt;:CLEar</code> ..... | 684 |

---

#### `SOURce<Ch>:LPORt<LogPt>` <PhysicalPort>[, <PhysicalPort>]

Assigns the logical port number <LogPt> either to the single-ended physical port <PhysicalPort1> or to a pair of physical ports <PhysicalPort1>,<PhysicalPort2>, at the same time defining them as balanced port.

#### Important:

- All required logical ports (balanced and single ended) must be created explicitly.
- A balanced port configuration generally introduces a new set of mixed mode measured quantities. Therefore the traces must be redefined when a balanced port is created. To avoid any inconsistencies the analyzer deletes all traces when `SOURce<Ch>:LPORt<LogPt>` is used.
- It is essential to complete the logical port assignment before defining other port properties such as common or differential mode impedances: whenever a logical port is created using `SOURce<Ch>:LPORt<LogPt>`, the parameters of all existing logical ports are reset.
- For a unidirectional R&S ZND (see [Chapter 3.1.4.2, "R&S ZND: Unidirectional vs. Bidirectional Operation"](#), on page 16) balanced ports are not available.

#### Suffix:

|         |                                                                                                                                                                                                                                     |
|---------|-------------------------------------------------------------------------------------------------------------------------------------------------------------------------------------------------------------------------------------|
| <Ch>    | Channel number.                                                                                                                                                                                                                     |
| <LogPt> | Identifying number of the newly created balanced or single-ended logical port.<br>Must be between 1 and the number of physical ports (see <a href="#">INSTrument:TPORt:COUNt?</a> ). If unspecified the numeric suffix is set to 1. |

#### Parameters:

|                |                                                                                                                                                                                                                                                        |
|----------------|--------------------------------------------------------------------------------------------------------------------------------------------------------------------------------------------------------------------------------------------------------|
| <PhysicalPort> | Number of first/only physical port<br>Range: 1 to number of physical ports                                                                                                                                                                             |
| <PhysicalPort> | Number of second physical port (optional), forming a balanced port with the first physical port.<br>The port numbers must be different. Moreover, a physical port cannot be assigned to several logical ports.<br>Range: 1 to number of physical ports |

**Example:** \*RST; :SOUR:LPOR1 1,2; :LPOR2 4; :LPOR3 3  
 Combine the physical ports 1 and 2 to the logical port 1 (balanced) and assign physical ports 4 and 3 to logical ports 2 and 3, respectively  
 SOUR:LPOR1?  
 Query the physical ports assigned to logical port no. 1. The response is 1,2.  
 SOUR:GRO 1,2  
 Define logical ports no. 1 and 2 as used (group 1), port 3 as unused  
 SOUR:GRO?  
 Query the port group no. 1. The response is 1,2.  
 SOUR:GRO:CLE ALL; :SOUR:GRO?  
 Dissolve all port groups and repeat the query. The response is 1,n where n denotes the number of available test ports.  
 SOUR:LPOR:CLE ALL  
 SOUR:LPOR1?  
 Dissolve all logical ports and repeat the query. The response is 1: the logical port no. 1 is identical to the physical port no. 1.

**Example:** SOUR:GRO:PORT 1,3  
 Define logical ports no. 1 and 3 as used (group 1), logical ports 2 and 4 as unused  
 SOUR:GRO?  
 Query the port group no. 1. The response is 1,3.  
 SOUR:GRO:CLE; :SOUR:GRO?  
 Dissolve port group 1 and repeat the query. The response is again 1,n (all logical ports used).

**Manual operation:** See ["Select Predefined"](#) on page 133

---

### SOURce<Ch>:LPORt<LogPt>:CLEar [<Scope>]

Dissolves balanced port <LogPt> or all logical ports.

#### Suffix:

<Ch> Channel number  
 <LogPt> Logical port number used to number balanced ports.  
 Range according to the current port configuration (SOURce<Ch>:LPORt<LogPt>). If an undefined balanced port number is used, the analyzer generates an error message.  
 Exception: Parameter ALL, see below.

#### Setting parameters:

<Scope> ALL  
 If ALL is specified, all logical ports are dissolved; the <log\_port> suffix is ignored. If ALL is omitted, only the specified balanced port is dissolved.

**Example:** See SOURce<Ch>:LPORt<LogPt>

**Usage:** Setting only  
**Manual operation:** See ["Select Predefined"](#) on page 133

### 6.3.16.3 SOURce:GROup...

The `SOURce:GROup...` commands define the group of (un-)used logical ports.

|                                                            |     |
|------------------------------------------------------------|-----|
| <code>SOURce&lt;Ch&gt;:GROup&lt;Grp&gt;</code> .....       | 685 |
| <code>SOURce&lt;Ch&gt;:GROup&lt;Grp&gt;:PORTs</code> ..... | 685 |
| <code>SOURce&lt;Ch&gt;:GROup&lt;Grp&gt;:CLEar</code> ..... | 686 |

---

#### `SOURce<Ch>:GROup<Grp> <arg0>, <arg1>`

In "set direction" this command defines the set of active logical ports (the "master group") as the continuous range from `<log_port1>` to `<log_port2>`, i.e. logical ports outside this range are disabled.

In "get direction" it returns the minimum and maximum enabled logical port.

See `SOURce<Ch>:LPORt<LogPt>` on how to define logical ports.

**Suffix:**

`<Ch>` Channel number.  
`<Grp>` Port group number, must be 1 (or omitted).

**Parameters:**

`<arg0>`  
`<arg1>` First and last logical port number in the port group. Must be omitted if the command is used as a query.

**Example:** See `SOURce<Ch>:LPORt<LogPt>` on page 683

**Manual operation:** See ["Define Physical to Logical Port Relation"](#) on page 134

---

#### `SOURce<Ch>:GROup<Grp>:PORTs <arg0>, <arg1>...`

Defines the set of active logical ports (the "master group") as an arbitrary selection of logical ports. The ports do not have to be numbered consecutively (as for port groups defined via `SOURce<Ch>:GROup<Grp>`).

See `SOURce<Ch>:LPORt<LogPt>` on how to define logical ports.

**Suffix:**

`<Ch>` Channel number.  
`<Grp>` Port group number, must be 1 (or omitted).

**Parameters:**

`<arg0>`  
`<arg1>` Logical port numbers. Must be omitted if the command is used as a query.

**Manual operation:** See ["Define Physical to Logical Port Relation"](#) on page 134

**SOURce<Ch>:GROup<Grp>:CLEar [<arg0>]**

Dissolves the "master port group", i.e. reenables all logical ports.

**Suffix:**

|       |                                                                          |
|-------|--------------------------------------------------------------------------|
| <Ch>  | Channel number.                                                          |
| <Grp> | Port group number.<br>This suffix is ignored: only <Grp>=1 is supported. |

**Setting parameters:**

|        |                                                                                                                                                                                                                                                                                                                                                                                                                                     |
|--------|-------------------------------------------------------------------------------------------------------------------------------------------------------------------------------------------------------------------------------------------------------------------------------------------------------------------------------------------------------------------------------------------------------------------------------------|
| <arg0> | ALL<br>If ALL is specified, all port groups are dissolved and a default port group 1, consisting of all available ports, is restored; the <Grp> suffix is ignored.<br>If ALL is omitted, only the specified port group is dissolved, except the deleted port group was the only one, in which case again default port group 1 is restored. In case an undefined port group number is used, the analyzer generates an error message. |
|--------|-------------------------------------------------------------------------------------------------------------------------------------------------------------------------------------------------------------------------------------------------------------------------------------------------------------------------------------------------------------------------------------------------------------------------------------|

**Example:** See [SOURce<Ch>:LPORt<LogPt>](#) on page 683

**Usage:** Setting only

**Manual operation:** See ["Define Physical to Logical Port Relation"](#) on page 134

**6.3.16.4 SOURce:POWer...**

The `SOURce:POWer...` commands define the power of the internal and external signal sources and control a scalar source power calibration.

**Port-specific and general settings**

The `SOURce:POWer...` subsystem comprises port-specific and general settings. Port-specific settings are valid for the port specified by the numeric suffix <PhyPt> (...:POWer<PhyPt>:...). General settings are valid for all test ports of the analyzer; the port suffix is ignored. Refer to the description of the individual commands for more information.

**SOURce:POWer:CORRection...**

The `SOURce:POWer:CORRection...` commands control a scalar source power calibration.

|                                                                                                    |     |
|----------------------------------------------------------------------------------------------------|-----|
| <a href="#">SOURce&lt;Ch&gt;:POWer&lt;PhyPt&gt;:CORRection[:ACQuire].....</a>                      | 687 |
| <a href="#">SOURce&lt;Ch&gt;:POWer&lt;PhyPt&gt;:CORRection[:ACQuire]:VERification:RESult?.....</a> | 688 |
| <a href="#">SOURce&lt;Ch&gt;:POWer&lt;PhyPt&gt;:CORRection:COLLect:AVERage[:COUNT].....</a>        | 689 |
| <a href="#">SOURce&lt;Ch&gt;:POWer&lt;PhyPt&gt;:CORRection:COLLect:AVERage:NTOLerance.....</a>     | 689 |
| <a href="#">SOURce&lt;Ch&gt;:POWer&lt;PhyPt&gt;:CORRection:COLLect:CFActor.....</a>                | 690 |
| <a href="#">SOURce&lt;Ch&gt;:POWer&lt;PhyPt&gt;:CORRection:COLLect:PMReadings.....</a>             | 690 |
| <a href="#">SOURce&lt;Ch&gt;:POWer:CORRection:DATA.....</a>                                        | 691 |
| <a href="#">SOURce&lt;Ch&gt;:POWer&lt;PhyPt&gt;:CORRection:GENERator&lt;Gen&gt;[:STATe].....</a>   | 691 |

|                                                                             |     |
|-----------------------------------------------------------------------------|-----|
| SOURce<Ch>:POWer<PhyPt>:CORRection:NREadings.....                           | 692 |
| SOURce<Ch>:POWer<PhyPt>:CORRection:OSources[:STATe].....                    | 692 |
| SOURce:POWer:CORRection:PMETer:ID.....                                      | 693 |
| SOURce<Ch>:POWer<PhyPt>:CORRection:PPOWer.....                              | 693 |
| SOURce<Ch>:POWer<PhyPt>:CORRection:PSElect.....                             | 693 |
| SOURce<Ch>:POWer<PhyPt>:CORRection:STATe.....                               | 694 |
| SOURce<Ch>:POWer<PhyPt>:CORRection:TCoefficient:CALibration.....            | 694 |
| SOURce<Ch>:POWer<PhyPt>:CORRection:TCoefficient:COUNt?.....                 | 695 |
| SOURce<Ch>:POWer<PhyPt>:CORRection:TCoefficient:DEFine<ListNo>.....         | 696 |
| SOURce<Ch>:POWer<PhyPt>:CORRection:TCoefficient:DELete<ListNo>:ALL.....     | 696 |
| SOURce<Ch>:POWer<PhyPt>:CORRection:TCoefficient:DELete<ListNo>[:DUMMy]..... | 697 |
| SOURce<Ch>:POWer<PhyPt>:CORRection:TCoefficient:FEED.....                   | 697 |
| SOURce<Ch>:POWer<PhyPt>:CORRection:TCoefficient:INSert<ListNo>.....         | 698 |
| SOURce<Ch>:POWer<PhyPt>:CORRection:TCoefficient[:STATe].....                | 698 |
| SOURce<Ch>:POWer<PhyPt>:CORRection:DATA:PARAmeter<Wv>:COUNt?.....           | 699 |
| SOURce<Ch>:POWer:CORRection:DATA:PARAmeter<Wv>?.....                        | 699 |

---

**SOURce<Ch>:POWer<PhyPt>:CORRection[:ACQuire] <SourceType>[,  
<SourcePort>]**

Selects the source for the source power calibration, starts and applies the source power calibration.

**Note:** The command cannot be used unless a power meter is connected via GPIB bus, USB or LAN interface and configured in the "External Power Meters" dialog.

**Suffix:**

|         |                                                                                                            |
|---------|------------------------------------------------------------------------------------------------------------|
| <Ch>    | Calibrated channel number                                                                                  |
| <PhyPt> | Calibrated port number. This suffix is ignored because the port number is specified in the parameter list. |

**Setting parameters:**

|              |                                                                                                                                                                                                                                                                                                                                                                                                                                |
|--------------|--------------------------------------------------------------------------------------------------------------------------------------------------------------------------------------------------------------------------------------------------------------------------------------------------------------------------------------------------------------------------------------------------------------------------------|
| <SourceType> | PORT   GENerator   A1   A2   A3   A4   ESRC1   ESRC2<br>PORT – analyzer port is the source of the calibrated wave.<br>GENerator – not supported.<br>The port numbers are specified by means of the<br><SourcePort> parameter.<br>A1   A2   A3   A4 – direct analyzer port selection. The parameters A1 and A2 are ZVR-compatible. No additional port number parameter needs to be specified.<br>ESRC1   ESRC2 – not supported. |
| <SourcePort> | Analyzer port number, if PORT is the first parameter.<br>Range: 1 to port number of the analyzer / number of external generators.                                                                                                                                                                                                                                                                                              |

**Example:**

```
SOUR:POW:CORR:OSO:STAT OFF
```

To improve the accuracy, switch off all other sources during the calibration sweep.

```
SOUR:POWer:CORR:COLL:METH RRAF; PMR 2
```

Enable fast power correction with two power meter readings.

```
SOUR:POW:CORR:NRE 2; COLL:AVER:NTOL 0.5
```

Increase the number of readings and reduce the power tolerance to improve the accuracy.

```
SOURce:POW:CORR:COLL:CFAC 0.9
```

Reduce the correction factor to 0.9.

```
SOURce:POW:CORR:PSElect PPOW; PPOWer -5
```

Define reference receiver cal power which is independent of the port power; set its value to -5 dBm.

```
SOUR:POW:CORR:ACQ PORT,1
```

Perform a source power calibration using port 1 as a source port.

```
SOUR:POW:CORR:STAT?
```

Check whether the calibration is applied (the response is 1).

**Usage:**

Setting only

**Manual operation:** See "[Port Overview](#)" on page 269

**SOURce<Ch>:POWer<PhyPt>:CORREction[:ACQuire]:VERification:RESult?**

Returns (and deletes) the result of the last verification sweep. The response contains three values:

- <Channel> – calibrated channel, e.g. Ch 1 for channel no. 1.
- <Boolean> – 1 for "calibration passed" (the maximum offset is below the tolerance), 0 for "calibration failed".
- <MaxOffset> – maximum power offset between the measured power at the reference plane and the "Cal Power" during the verification sweep in dB.

If no verification sweep is available, or if the result has been queried already, the response is 0.

**Suffix:**

<Ch>

Calibrated channel number. This suffix is ignored; the result is based on the last verification sweep acquired.

<PhyPt>

Calibrated port number. This suffix is ignored; the result is based on the last verification sweep acquired.



- Example:** `*RST; :SOURce:POWer:CORRection:NREadings 2`  
`SOURce:POWer:CORRection:COLLect:AVERage:`  
`NTOLerance 0.5`  
 Increase the number of readings and reduce the power tolerance to improve the accuracy.  
`SOURce:POWer:CORRection:ACQuire PORT,1`  
 Perform a source power calibration using port 1 as a source port.  
`SOURce:POWer:CORRection:ACQuire:VERification:RESult?`  
 Query the result of the verification sweep. Possible response:  
`Ch1 1,9.9E+002`
- Usage:** Query only
- Manual operation:** See "[Calibration Sweep Diagram](#)" on page 269

**SOURce<Ch>:POWer<PhyPt>:CORRection:COLLect:AVERage[:COUNT]**  
 <NoReadings>

Sets a limit for the number of calibration sweeps in the source power calibration. The command is valid for all channels, ports and external generators. Equivalent command: [SOURce<Ch>:POWer<PhyPt>:CORRection:NREadings](#).

**Suffix:**

- <Ch> Calibrated channel number. This parameter is ignored; the limit applies to all channels.
- <PhyPt> Calibrated port number. This parameter is ignored; the limit applies to all sources.

**Parameters:**

- <NoReadings> Number of readings  
 Range: 1 to 100  
 \*RST: 2

**Example:** See [SOURce<Ch>:POWer<PhyPt>:CORRection\[:ACQuire\]](#) (for equivalent command [SOURce<Ch>:POWer<PhyPt>:CORRection:NREadings](#))

**Manual operation:** See "[Flatness Cal > Total Readings](#)" on page 287

**SOURce<Ch>:POWer<PhyPt>:CORRection:COLLect:AVERage:NTOLerance**  
 <Tolerance>

Specifies the maximum deviation of the measured power from the target power of the calibration. The command is valid for all channels and calibrated ports.

**Suffix:**

- <Ch> Calibrated channel number. This parameter is ignored; the tolerance value is valid for all sources.

<PhyPt> Calibrated port number. This parameter is ignored; the tolerance value is valid for all sources.

**Parameters:**

<Tolerance> Tolerance value  
 Range: 0.001 dB to 1000 dB  
 \*RST: 1 dB  
 Default unit: dB

**Example:** See `SOURce<Ch>:POWer<PhyPt>:CORRection[:ACQuire]`

**Manual operation:** See "[Flatness Cal > Tolerance](#)" on page 287

**SOURce<Ch>:POWer<PhyPt>:CORRection:COLLect:CFACTOR <Convergence>**

Specifies the convergence factor for a source power calibration.

**Suffix:**

<Ch> Calibrated channel number. This parameter is ignored; the convergence factor is valid for all sources.

<PhyPt> Calibrated port number. This parameter is ignored; the convergence factor is valid for all sources.

**Parameters:**

<Convergence> Convergence factor  
 Range: 0 to 2  
 Increment: 1 dB  
 \*RST: 1

**Example:** See `SOURce<Ch>:POWer<PhyPt>:CORRection[:ACQuire]`

**Manual operation:** See "[Flatness Cal > Convergence](#)" on page 287

**SOURce<Ch>:POWer<PhyPt>:CORRection:COLLect:PMReadings <NoReadings>**

Selects the number of power meter readings for source power calibration method `SOURce<Ch>:POWer<PhyPt>:CORRection:COLLect:METhod RRAfter`.

**Suffix:**

<Ch> Calibrated channel number. This parameter is ignored; the parameter is valid for all channels.

<PhyPt> Calibrated port number. This parameter is ignored; the parameter is valid for all sources.

**Parameters:**

<NoReadings> Number of power meter readings. If the value exceeds the maximum number of calibration sweeps (`SOURce<Ch>:POWer<PhyPt>:CORRection:COLLect:AVERage[:COUNT]`) the latter is adjusted.  
 Range: 1 to 100  
 \*RST: 1

**Example:** See `SOURce<Ch>:POWER<PhyPt>:CORRection[:ACQuire]`

---

### **SOURce<Ch>:POWER:CORRection:DATA** <Source>, <CorrData>...

Reads or writes scalar source power correction data sets. A power correction data set contains n real values where:

- Each value corresponds to the ratio of the actual power at the reference plane (value provided by the used source) to the uncalibrated power in dB.
- The number n is equal to the number of sweep points.

Increasing (decreasing) the values in the correction data sets increases (decreases) the power at the reference plane. Writing correction data (the setting command) fails if the number of transferred values is not equal to the number of sweep points.

#### **Suffix:**

<Ch> Calibrated channel number

#### **Parameters:**

<Source> Identifier for the source of the calibrated wave:  
'A<n>' or 'PORT<n>' denote correction data for the analyzer port no. <n>.

<CorrData> Power correction values either in ASCII or block data format, depending on the current `FORMat[:DATA]` setting.  
All numbers are interpreted as dB-values.

#### **Example:**

```
*RST; :SWE:POIN 10
```

Reset the instrument and reduce the number of sweep points to 10.

```
SOUR:POW:CORR:ACQ PORT,1
```

Perform a source power calibration using port 1 as a source port.

```
SOUR:POW:CORR:DATA? 'A1'
```

Query the correction values. The analyzer returns 10 comma-separated real numbers.

```
SOUR:POW:CORR:DATA 'A1', 1, 2, 3, 4, 5, -6, -7, -8, -9, -0
```

Replace the correction values by ten (new) numbers.

**Manual operation:** See "Apply" on page 270

---

### **SOURce<Ch>:POWER<PhyPt>:CORRection:GENerator<Gen>[:STATe]** <Boolean>

Enables or disables the source power calibration for channel <Ch> and for an external generator number <Gen>. The command is disabled unless a source power calibration for the external generator has been performed (`SOURce<Ch>:POWER<PhyPt>:CORRection[:ACQuire]`). To enable or disable a source power calibration for an analyzer port use `SOURce<Ch>:POWER<PhyPt>:CORRection:STATe`.

#### **Suffix:**

<Ch> Calibrated channel number

|                    |                                                                                      |
|--------------------|--------------------------------------------------------------------------------------|
| <PhyPt>            | Calibrated port number. This suffix is ignored; the generator is selected via <Gen>. |
| <Gen>              | Generator number                                                                     |
| <b>Parameters:</b> |                                                                                      |
| <Boolean>          | Enables (ON) or disables (OFF) the source power calibration for port number <PhyPt>. |
|                    | *RST: OFF                                                                            |
| <b>Example:</b>    | See <a href="#">SOURce&lt;Ch&gt;:POWER&lt;PhyPt&gt;:CORRection[:ACQuire]</a>         |

### **SOURce<Ch>:POWER<PhyPt>:CORRection:NREadings <NoCalSweeps>**

Sets a limit for the number of calibration sweeps in the source power calibration. The command is valid for all channels, ports and external generators. Equivalent command: [SOURce<Ch>:POWER<PhyPt>:CORRection:COLLect:AVERage\[:COUNT\]](#).

#### **Suffix:**

|         |                                                                                         |
|---------|-----------------------------------------------------------------------------------------|
| <Ch>    | Calibrated channel number. This parameter is ignored; the limit applies to all sources. |
| <PhyPt> | Calibrated port number. This parameter is ignored; the limit applies to all sources.    |

#### **Parameters:**

|               |                    |
|---------------|--------------------|
| <NoCalSweeps> | Number of readings |
|               | Range: 1 to 100    |
|               | *RST: 2            |

**Example:** See [SOURce<Ch>:POWER<PhyPt>:CORRection\[:ACQuire\]](#)

**Manual operation:** See "[Flatness Cal > Total Readings](#)" on page 287

### **SOURce<Ch>:POWER<PhyPt>:CORRection:OSources[:STATe] <Boolean>**

Switches off all other sources during the calibration sweep for channel <Ch>.

#### **Suffix:**

|         |                                                                                          |
|---------|------------------------------------------------------------------------------------------|
| <Ch>    | Calibrated channel number                                                                |
| <PhyPt> | Calibrated port number. This parameter is ignored; the setting is valid for all sources. |

#### **Parameters:**

|           |                                                                                                                    |
|-----------|--------------------------------------------------------------------------------------------------------------------|
| <Boolean> | ON - other sources not necessarily switched off.<br>OFF - other sources switched off during the calibration sweep. |
|           | *RST: ON                                                                                                           |

**Example:** See [SOURce<Ch>:POWER<PhyPt>:CORRection\[:ACQuire\]](#)

**Manual operation:** See "[Switch Off All Other Sources](#)" on page 287

**SOURce:POWer:CORRection:PMETer:ID** <PowerMeter>

Selects an external power meter for the scalar source power calibration (flatness calibration).

**Note:** The command cannot be used unless a power meter is connected via GPIB bus, USB or LAN interface and configured in the "External Power Meters" dialog.

**Parameters:**

<PowerMeter>      Number of external power meter. The parameters UP, DOWN, MIN, MAX are not available for this command.

Range:            1 to number of configured external generators

\*RST:            The power meter selection is not changed by a reset of the analyzer.

**Example:**            See [SOURce<Ch>:POWer<PhyPt>:CORRection:COLLect\[:ACQuire\]](#) on page 764

**Manual operation:**    See ["Power Meter"](#) on page 287

**SOURce<Ch>:POWer<PhyPt>:CORRection:PPOWer** <RecCalPower>

Defines the source power which the R&S ZNC/ZND uses to perform the first calibration sweep of the source power calibration ("Reference Receiver Cal Power"). The power value is ignored if the R&S ZNC/ZND is set to use the port power result ([SOURce<Ch>:POWer<PhyPt>:CORRection:PSElectCPOW](#)).

**Suffix:**

<Ch>                    Calibrated channel number. This parameter is ignored; the parameter is valid for all channels.

<PhyPt>                Calibrated port number. This parameter is ignored; the parameter is valid for all sources.

**Parameters:**

<RecCalPower>        Reference receiver cal power

Range:                Depending on source power range of the analyzer and the power range of the external power meter.

\*RST:                0 dBm

Default unit: dBm

**Example:**            See [SOURce<Ch>:POWer<PhyPt>:CORRection\[:ACQuire\]](#)

**Manual operation:**    See ["Reference Receiver Cal Power"](#) on page 289

**SOURce<Ch>:POWer<PhyPt>:CORRection:PSElect** <CalPower>

Qualifies how to define the source power which the R&S ZNC/ZND uses to perform the first calibration sweep of the source power calibration ("Reference Receiver Cal Power").

**Suffix:**

<Ch>                    Calibrated channel number. This parameter is ignored; the parameter is valid for all channels.

<PhyPt>                Calibrated port number. This parameter is ignored; the parameter is valid for all sources.

**Parameters:**

<CalPower>            CPOWER | PPOWER  
 PPOWER – use cal power value defined via `SOURce<Ch>:POWER<PhyPt>:CORRection:PPOWER`  
 CPOWER – use port power value

\*RST:                  PPOWER

**Example:**            See `SOURce<Ch>:POWER<PhyPt>:CORRection[:ACQuire]`  
 .

**Manual operation:** See "Reference Receiver Cal Power" on page 289

#### **SOURce<Ch>:POWER<PhyPt>:CORRection:STATe** <Boolean>

Enables or disables the source power calibration for channel <Ch> and for port number <PhyPt>. The setting command is disabled unless a source power calibration for the analyzer port has been performed (`SOURce<Ch>:POWER<PhyPt>:CORRection[:ACQuire]`). The query always returns a result.

**Suffix:**

<Ch>                    Calibrated channel number

<PhyPt>                Calibrated port number

**Parameters:**

<Boolean>            Enables (ON) or disables (OFF) the source power calibration for port number <PhyPt>.

\*RST:                  OFF

**Example:**            See `SOURce<Ch>:POWER<PhyPt>:CORRection[:ACQuire]`  
 .

**Manual operation:** See "Port Overview" on page 293

#### **SOURce<Ch>:POWER<PhyPt>:CORRection:TCoefficient:CALibration** <Boolean>

Selects the position of the additional two-port in the test setup.

**Suffix:**

<Ch>                    Calibrated channel number. This parameter is ignored; the transmission coefficient settings are valid for all channels.

<PhyPt>                Calibrated port number. This parameter is ignored; the transmission coefficient settings are valid for all sources.

**Parameters:**

&lt;Boolean&gt;

ON – two port at power meter (during calibration)

OFF – two port at DUT (during measurement)

\*RST: ON (notice that the correction is switched off after a reset)

**Example:**

RST; :SOUR:POW:CORR:TCO:CAL OFF

Select the test setup with the additional two-port in front of the DUT.

SOUR:POW:CORR:TCO:DEF 1GHz, -5; DEF 2GHz, -10;  
DEF2?

Define two points in the power loss list; query the second point.

SOUR:POW:CORR:TCO:INS2 1.5 GHz, -7.5

Insert a third point as point no. 2 in the list.

**Example:**

SOUR:POW:CORR:TCO:COUN?

Query the number of points. The response is 3.

SOUR:POW:CORR:TCO ON

Enable the use of two-port transmission coefficients.

SOUR:POW:CORR:TCO:FEED 'Trc1'

Replace the previous 3 points by the trace points of the default trace "Trc1".

**Example:**

MMEM:STOR:CORR:TCO 'C:

\Users\Public\Documents\Rohde-Schwarz\Vna  
\PowerMeterCorr\Test.pmcl'

Store the power loss list to the power meter correction list file Test.pmcl in the directory

C:\Users\Public\Documents\Rohde-Schwarz\Vna  
\PowerMeterCorr.MMEM:LOAD:CORR:TCO 'C:\Users\Public\Documents  
\Rohde-Schwarz\Vna\PowerMeterCorr\Test.pmcl'

Re-load the stored power meter correction list file.

**Example:**

SOUR:POW:CORR:TCO:DEL1

Delete the first point in the list.

SOUR:POW:CORR:TCO:DEL:ALL; :SOUR:POW:CORR:TCO?

Clear the entire list. Query whether the transmission coefficients are still taken into account. The response is 0.

MMEM:LOAD:CORR:TCO 'C:\Users\Public\Documents  
\Rohde-Schwarz\Vna\Traces\Test.s2p', 'S21'

Load a power loss list from a previously created 2-port Touchstone file.

**Manual operation:** See "Test Setup" on page 290**SOURce<Ch>:POWER<PhyPt>:CORREction:TCOefficient:COUNT?**

Queries the number of frequency values and transmission coefficients in the power loss list.

|                          |                                                                                                                         |
|--------------------------|-------------------------------------------------------------------------------------------------------------------------|
| <b>Suffix:</b>           |                                                                                                                         |
| <Ch>                     | Calibrated channel number. This parameter is ignored; the transmission coefficient settings are valid for all channels. |
| <PhyPt>                  | Calibrated port number. This parameter is ignored; the transmission coefficient settings are valid for all sources.     |
| <b>Example:</b>          | See <a href="#">SOURCE&lt;Ch&gt;:POWER&lt;PhyPt&gt;:CORREction:TCoefficient:CALibration</a>                             |
| <b>Usage:</b>            | Query only                                                                                                              |
| <b>Manual operation:</b> | See " <a href="#">Transmission Coefficients; Insert / Delete / Delete All</a> " on page 291                             |

**SOURCE<Ch>:POWER<PhyPt>:CORREction:TCoefficient:DEFine<ListNo>  
<Frequency>, <TransCoeff>**

Adds a new frequency and transmission coefficient to the end of the power loss list. The query returns the frequency and transmission coefficient no. <ListNo>.

|                          |                                                                                                                                                                                                                                                                       |
|--------------------------|-----------------------------------------------------------------------------------------------------------------------------------------------------------------------------------------------------------------------------------------------------------------------|
| <b>Suffix:</b>           |                                                                                                                                                                                                                                                                       |
| <Ch>                     | Calibrated channel number. This parameter is ignored; the transmission coefficient settings are valid for all channels.                                                                                                                                               |
| <PhyPt>                  | Calibrated port number. This parameter is ignored; the transmission coefficient settings are valid for all sources.                                                                                                                                                   |
| <ListNo>                 | Number of point in the list. This suffix is only used for queries.                                                                                                                                                                                                    |
| <b>Parameters:</b>       |                                                                                                                                                                                                                                                                       |
| <Frequency>              | Stimulus frequency value. If several points with identical frequencies are added, the analyzer automatically ensures a frequency spacing of 1 Hz.<br>Range: Stimulus values outside the frequency range of the analyzer are allowed.<br>*RST: n/a<br>Default unit: Hz |
| <TransCoeff>             | Transmission coefficient<br>Range: -300 dB to +200 dB<br>*RST: n/a<br>Default unit: dB                                                                                                                                                                                |
| <b>Example:</b>          | See <a href="#">SOURCE&lt;Ch&gt;:POWER&lt;PhyPt&gt;:CORREction:TCoefficient:CALibration</a>                                                                                                                                                                           |
| <b>Manual operation:</b> | See " <a href="#">Transmission Coefficients; Insert / Delete / Delete All</a> " on page 291                                                                                                                                                                           |

**SOURCE<Ch>:POWER<PhyPt>:CORREction:TCoefficient:DELeTe<ListNo>:ALL**

Clears the power loss list.



|                          |                                                                                                                         |
|--------------------------|-------------------------------------------------------------------------------------------------------------------------|
| <b>Suffix:</b>           |                                                                                                                         |
| <Ch>                     | Calibrated channel number. This parameter is ignored; the transmission coefficient settings are valid for all channels. |
| <PhyPt>                  | Calibrated port number. This parameter is ignored; the transmission coefficient settings are valid for all sources.     |
| <ListNo>                 | Number of point in the list. This suffix is ignored; the command deletes all points.                                    |
| <b>Example:</b>          | See <code>SOURce&lt;Ch&gt;:POWer&lt;PhyPt&gt;:CORRection:TCOefficient:CALibration</code>                                |
| <b>Usage:</b>            | Event                                                                                                                   |
| <b>Manual operation:</b> | See " <a href="#">Transmission Coefficients; Insert / Delete / Delete All</a> " on page 291                             |

### **SOURce<Ch>:POWer<PhyPt>:CORRection:TCOefficient:DELeTe<ListNo>[:DUMMy]**

Deletes a single point no. <ListNo> in the power loss list.

|                          |                                                                                                                         |
|--------------------------|-------------------------------------------------------------------------------------------------------------------------|
| <b>Suffix:</b>           |                                                                                                                         |
| <Ch>                     | Calibrated channel number. This parameter is ignored; the transmission coefficient settings are valid for all channels. |
| <PhyPt>                  | Calibrated port number. This parameter is ignored; the transmission coefficient settings are valid for all sources.     |
| <ListNo>                 | Number of point in the list.                                                                                            |
| <b>Example:</b>          | See <code>SOURce&lt;Ch&gt;:POWer&lt;PhyPt&gt;:CORRection:TCOefficient:CALibration</code>                                |
| <b>Manual operation:</b> | See " <a href="#">Transmission Coefficients; Insert / Delete / Delete All</a> " on page 291                             |

### **SOURce<Ch>:POWer<PhyPt>:CORRection:TCOefficient:FEED <Trace>**

Selects a trace which provides the points for the power loss list.

|                            |                                                                                                                         |
|----------------------------|-------------------------------------------------------------------------------------------------------------------------|
| <b>Suffix:</b>             |                                                                                                                         |
| <Ch>                       | Calibrated channel number. This parameter is ignored; the transmission coefficient settings are valid for all channels. |
| <PhyPt>                    | Calibrated port number. This parameter is ignored; the transmission coefficient settings are valid for all sources.     |
| <b>Setting parameters:</b> |                                                                                                                         |
| <Trace>                    | String parameter for the trace name, e.g. 'Trc1'. The trace must exist in the active recall set.                        |
| *RST:                      | n/a                                                                                                                     |

**Example:** See `SOURce<Ch>:POWer<PhyPt>:CORRection:TCOefficient:CALibration`

**Usage:** Setting only

**Manual operation:** See "Get Trace..." on page 291

**SOURce<Ch>:POWer<PhyPt>:CORRection:TCOefficient:INSert<ListNo>**  
 <Frequency>, <TransCoeff>

Inserts a new frequency and transmission coefficient at position no. <ListNo> in the power loss list. The following points are shifted down in the list.

**Suffix:**

<Ch> Calibrated channel number. This parameter is ignored; the transmission coefficient settings are valid for all channels.

<PhyPt> Calibrated port number. This parameter is ignored; the transmission coefficient settings are valid for all sources.

<ListNo> Number of point to insert in the list.

**Parameters:**

<Frequency> Stimulus frequency value. If several points with identical frequencies are added, the analyzer automatically ensures a frequency spacing of 1 Hz.  
 Range: Stimulus values outside the frequency range of the analyzer are allowed.  
 \*RST: n/a  
 Default unit: Hz

<TransCoeff> Transmission coefficient  
 Range: -300 dB to +200 dB  
 \*RST: n/a  
 Default unit: dB

**Example:** See `SOURce<Ch>:POWer<PhyPt>:CORRection:TCOefficient:CALibration`

**Manual operation:** See "Transmission Coefficients; Insert / Delete / Delete All" on page 291

**SOURce<Ch>:POWer<PhyPt>:CORRection:TCOefficient[:STATe] <Boolean>**

Enables or disables the use of two-port transmission coefficients.

**Suffix:**

<Ch> Calibrated channel number. This parameter is ignored; the transmission coefficient settings are valid for all channels.

<PhyPt> Calibrated port number. This parameter is ignored; the transmission coefficient settings are valid for all sources.

**Parameters:**

<Boolean> Enables (ON) or disables (OFF) the two-port transmission coefficients.  
 \*RST: n/a

**Example:**

See `SOURce<Ch>:POWer<PhyPt>:CORRection:TCOefficient:CALibration`

**Manual operation:** See "Test Setup" on page 290

**SOURce<Ch>:POWer<PhyPt>:CORRection:DATA:PARAmeter<Wv>:COUNT?**

Gets the number of available power calibrations (both source power and measurement receiver).

Use `SOURce<Ch>:POWer:CORRection:DATA:PARAmeter<Wv>?` to retrieve the related settings.

**Suffix:**

<Ch> Number of the calibrated channel.

<PhyPt> This suffix is ignored.

<Wv> This suffix is ignored.

**Usage:** Query only

**Manual operation:** See "Port Overview" on page 269

**SOURce<Ch>:POWer:CORRection:DATA:PARAmeter<Wv>?<br><PowerCalSettingType>[, <Index>]**

Gets settings of the available power calibrations.

**Suffix:**

<Ch> Number of the calibrated channel.

<Wv> Number of the power calibration.

Use `SOURce<Ch>:POWer<PhyPt>:CORRection:DATA:PARAmeter<Wv>:COUNT?` on page 699 to query the number of available power calibrations.

**Query parameters:**

<PowerCalSettingType> WAVE | START | STOP | POINTs | STYPE | ATTenuation |  
CPOWER | CFRequency | TSTamp | LTSTamp | TVNA | MVNA |  
MTEST | FSMode

**WAVE**

Calibrated port and calibration type (Gen=Source Power,  
Rec=Measurement Receiver)

**START**

Start Frequency or Power

Stop Frequency or Power

**POINTs**

Nr. of sweep points

**STYPE**

Sweep type or grid (LIN, LOG, SEGM)

**ATTenuation**

Source or receiver attenuation

**CPOWER**

Cal Power for frequency sweeps

**CFRequency**

Cal Frequency for power sweeps

**TSTamp**

Timestamp in UTC

**LTSTamp**

Timestamp in local time

<Index> Not used

**Usage:** Query only

**Manual operation:** See "[Port Overview](#)" on page 269

**SOURCE:POWER... (Contd.)**

The SOURCE:POWER... commands define the power of the internal signal source.

|                                                              |     |
|--------------------------------------------------------------|-----|
| SOURCE<Ch>:POWER<PhyPt>:CORRection:LEVel:OFFSet.....         | 701 |
| SOURCE<Ch>:POWER<PhyPt>[:LEVel][:IMMEDIATE][:AMPLitude]..... | 701 |
| SOURCE<Ch>:POWER<PhyPt>[:LEVel][:IMMEDIATE]:OFFSet.....      | 702 |
| SOURCE<Ch>:POWER<PhyPt>[:LEVel][:IMMEDIATE]:SLOPe.....       | 703 |
| SOURCE<Ch>:POWER<PhyPt>:REDuce[:STATE].....                  | 703 |
| SOURCE<Ch>:POWER<PhyPt>:REDuce:SDELay.....                   | 704 |
| SOURCE<Ch>:POWER<PhyPt>:STATE.....                           | 704 |
| SOURCE<Ch>:POWER<PhyPt>:SWEpend:MODE.....                    | 705 |
| SOURCE<Ch>:POWER<PhyPt>:SWEpend:SDELay.....                  | 705 |
| SOURCE<Ch>:POWER<PhyPt>:START.....                           | 706 |
| SOURCE<Ch>:POWER<PhyPt>:STOP.....                            | 706 |

**SOURce<Ch>:POWER<PhyPt>:CORREction:LEVel:OFFSet <Offset>**

Specifies a gain (positive values) or an attenuation (negative values) in the signal path between the source port and the calibrated reference plane. The value has no impact on the source power.

**Suffix:**

<Ch>                      Calibrated channel number

<PhyPt>                  Calibrated port number

**Parameters:**

<Offset>                  Gain or attenuation value

Range:                  -300 dB to +300 dB (adjust to the test setup)

Increment:              0.01 dB (other values are rounded)

\*RST:                    0 dB

Default unit: dB

**Example:**

Assume that a DUT requires a constant input power of +35 dBm at port 2, and that the measurement path contains an amplifier with a 30 dB gain.

```
*RST; SOUR:POW 0
```

Reset the instrument and set the internal source power (base channel power) for the default channel 1 to 0 dBm.

```
SOUR:POW2:OFFS 5, ONLY
```

Replace the source power at port 2 by +5 dBm. The powers at the remaining ports are not affected.

```
SOUR:POW2:CORR:LEV:OFFS 30
```

Specify the gain of the amplifier in the signal path between the analyzer port 2 and the input port of the DUT.

```
SOUR:POW:CORR:ACQ PORT, 2
```

Perform a source power calibration using port 2 as a source port and the target power of +35 dBm.

**Manual operation:** See "[Port Overview](#)" on page 288

**SOURce<Ch>:POWER<PhyPt>[:LEVel][:IMMEDIATE][:AMPLitude] <IntSourcePow>**

Defines the power of the internal signal source (channel power). The setting is valid for all sweep types except power sweep.

**Tip:** Use `SOURce<Ch>:POWER<PhyPt>:START` and `SOURce<Ch>:POWER<PhyPt>:STOP` to define the sweep range for a power sweep.

**Suffix:**

<Ch>                      Channel number

<PhyPt> Test port number of the analyzer. This suffix is ignored because the selected channel power applies to all source ports used in the active channel. It is possible though to define a port-specific slope factor for the source power (`SOURce<Ch>:POWER<PhyPt>[:LEVel][:IMMediate]:SLOPe`) and a port-specific power offset (`SOURce<Ch>:POWER<PhyPt>[:LEVel][:IMMediate]:OFFSet`).

**Parameters:**

<IntSourcePow> Internal source power  
 Range: -300 dBm to +200 dBm. The usable power range is frequency-dependent; refer to the data sheet.  
 Increment: 0.1 dB  
 \*RST: -10 dBm  
 Default unit: dBm

**Example:**

```
FUNC "XFR:POW:RAT B1, A2"
```

Activate a frequency sweep and select the ratio B1/A2 as measured parameter for channel and trace no. 1.

```
SOUR:POW -6
```

Set the internal source power for channel 1 to -6 dBm.

```
SOUR:POW2:SLOP 10
```

Set the power slope factor for the wave transmitted at port 2 to 10 dB/GHz. The internal source power and the waves at the other test ports are not affected.

**Manual operation:** See "Power" on page 230

---

**SOURce<Ch>:POWER<PhyPt>[:LEVel][:IMMediate]:OFFSet <Offset>, <OffsetType>**

Defines a port-specific source power or a power offset relative to the channel power (`SOURce<Ch>:POWER<PhyPt>[:LEVel][:IMMediate][:AMPLitude]`). An additional "Cal Power Offset" can be defined via `SOURce<Ch>:POWER<PhyPt>:CORRection:LEVel:OFFSet`.

**Suffix:**

<Ch> Channel number  
 <PhyPt> Test port number of the analyzer

**Parameters:**

<Offset> Port-specific power offset  
 Range: -300 dB to +300 dB (adjust to the analyzer's actual source power range and the test setup)  
 Increment: 0.01 dB (other values are rounded)  
 \*RST: 0 dB  
 Default unit: dB

|                          |                                                                                                                                                                                                                                                                                                                                                                           |
|--------------------------|---------------------------------------------------------------------------------------------------------------------------------------------------------------------------------------------------------------------------------------------------------------------------------------------------------------------------------------------------------------------------|
| <OffsetType>             | ONLY   CPADd<br>ONLY - only the port-specific power is used; the channel power is ignored.<br>CPADd - the port-specific power is added as an offset to the channel power.<br>*RST: CPADd                                                                                                                                                                                  |
| <b>Example:</b>          | *RST; SOUR:POW -6<br>Reset the instrument, activating a frequency sweep and set the internal source power (channel power) for the default channel 1 to -6 dBm.<br>SOUR:POW1:OFFS 6, ONLY; SOUR:POW2:OFFS 6, CPAD<br>Replace the source power at port 1 by +6 dBm, the source power at port 2 by 0 dBm. The powers at the remaining ports (if available) are not affected. |
| <b>Manual operation:</b> | See " <a href="#">Port Overview</a> " on page 288                                                                                                                                                                                                                                                                                                                         |

---

**SOURce<Ch>:POWER<PhyPt>[:LEVel][:IMMediate]:SLOPe <Slope>**

Defines a linear factor to modify the internal source power at port <PhyPt> as a function of the stimulus frequency.

**Suffix:**

|         |                                  |
|---------|----------------------------------|
| <Ch>    | Channel number                   |
| <PhyPt> | Test port number of the analyzer |

**Parameters:**

|         |                                                                                                                                                                                                                                                                      |
|---------|----------------------------------------------------------------------------------------------------------------------------------------------------------------------------------------------------------------------------------------------------------------------|
| <Slope> | Port-specific slope factor<br>Range: -40 dB/GHz to +40 dB/GHz. The resulting power range over the entire frequency sweep must be within the power range of the analyzer; refer to the data sheet.<br>Increment: 0.1-dB/GHz<br>*RST: 0 dB/GHz<br>Default unit: DB/GHZ |
|---------|----------------------------------------------------------------------------------------------------------------------------------------------------------------------------------------------------------------------------------------------------------------------|

**Example:** See `SOURce<Ch>:POWER<PhyPt>[:LEVel][:IMMediate][:AMPLitude]`

---

**SOURce<Ch>:POWER<PhyPt>:REDuce[:STATe] <ReduceAtSweepEnd>**

**Deprecated;** superseded by `SOURce<Ch>:POWER<PhyPt>:SWEpend:MODE`

Enables/disables power reduction at sweep end.

This is a global setting.

**Suffix:**

|      |                                                                                |
|------|--------------------------------------------------------------------------------|
| <Ch> | Channel number. This suffix is ignored; the setting is valid for all channels. |
|------|--------------------------------------------------------------------------------|

<PhyPt> Physical port number. This suffix is ignored; the setting is valid for all ports.

**Parameters:**

<ReduceAt  
SweepEnd>

**OFF** (default): at sweep end the output power of the sweep start is restored

**ON**: at sweep end the output power of the driving port is reduced as if the channel base power was set to its minimum possible value

**Example:**

See `SOURce<Ch>:POWER<PhyPt>:SWEpend:MODE`.

`REDuce:STATe OFF` is equivalent to `SWEpend:MODE AUTO`

`REDuce:STATe ON` is equivalent to `SWEpend:MODE REDuce`

**SOURce<Ch>:POWER<PhyPt>:REDuce:SDELay <SettlingDelay>**

Deprecated; superseded by `SOURce<Ch>:POWER<PhyPt>:SWEpend:SDELay`

If power reduction at sweep end is enabled (`SOURce<Ch>:POWER<PhyPt>:REDuce[:STATe] ON`) this defines the settling delay at subsequent sweep starts, i.e. the time between power-up and sweep start when a new sweep is requested.

This is a global setting.

**Suffix:**

<Ch>

Channel number. This suffix is ignored; the setting is valid for all channels.

<PhyPt>

Physical port number. This suffix is ignored; the setting is valid for all ports.

**Parameters:**

<SettlingDelay>

Settling delay

Default unit: s

**Example:**

See `SOURce<Ch>:POWER<PhyPt>:SWEpend:MODE` on page 705

**SOURce<Ch>:POWER<PhyPt>:STATe <Boolean>**

Turns the RF source power at a specified test port on or off.

**Suffix:**

<Ch>

Channel number

<PhyPt>

Test port number of the analyzer

**Parameters:**

<Boolean>

ON | OFF - turns the internal source power at the specified test port no. <PhyPt> on or off.

\*RST: ON



**Example:**            \*RST; SOUR:POW -6  
 Set the internal source power for channel 1 and all test ports to -6 dBm.  
                          SOUR:POW2:STAT?  
 Query whether the source power at test port 2 is on. The analyzer returns a 1.

### **SOURce<Ch>:POWER<PhyPt>:SWEepend:MODE <SweepEndModes>**

Selects the power mode at sweep end.

This is a global setting.

#### **Suffix:**

<Ch>                    Channel number. This suffix is ignored; the setting is valid for all channels.

<PhyPt>                Physical port number. This suffix is ignored; the setting is valid for all ports.

#### **Parameters:**

<SweepEndModes>    AUTO | REDuce | KEEP

AUTO: at sweep end restore the power at sweep start  
 REDuce: at sweep end reduce the output power as if the channel base power was set to its minimum possible value  
 KEEP: at sweep end keep the power at its current level

**Example:**            SOURce:POWer:SWEepend:MODE REDuce  
 Reduce power at sweep end.  
                          SOURce:POWer:SWEepend:SDELay 0.01  
 Use a settling delay of 10 ms  
                          SOURce:POWer:SWEepend:MODE AUTO  
 At sweep end, restore the power at sweep start

**Manual operation:**    See "[Power Mode at Sweep End](#)" on page 341

### **SOURce<Ch>:POWER<PhyPt>:SWEepend:SDELay <SettlingDelay>**

If sweep end mode REDuce or KEEP is active (see [SOURce<Ch>:POWER<PhyPt>:SWEepend:MODE](#)) this defines the settling delay at subsequent sweep starts, i.e. the time between power reset and sweep start when a new sweep is requested.

This is a global setting.

#### **Suffix:**

<Ch>                    Channel number. This suffix is ignored; the setting is valid for all channels.

<PhyPt>                Physical port number. This suffix is ignored; the setting is valid for all ports.

**Parameters:**

<SettlingDelay> Settling delay  
 Default unit: s

**Manual operation:** See "[Settling Delay / Reset Delay](#)" on page 342

**SOURce<Ch>:POWER<PhyPt>:START** <StartPower>

**SOURce<Ch>:POWER<PhyPt>:STOP** <StopPower>

These commands define the start and stop powers for a power sweep. The values also define the left and right edges of a Cartesian diagram. A power sweep must be active (`[SENSE<Ch>:]SWEep:TYPEPOWer`) to use these commands.

**Suffix:**

<Ch> Channel number

<PhyPt> Test port number of the analyzer. This suffix is ignored because the selected power sweep range applies to all source ports used in the active channel.

**Parameters:**

<StopPower> Start or stop power of the sweep.  
 Range: -150 dBm to +100 dBm. The usable power range is frequency-dependent; refer to the data sheet.  
 Increment: 0.01 dB  
 \*RST: -25 dBm start power, 0 dBm stop power  
 Default unit: dBm

**Example:**

```
SWE:TYPE POW
Activate a power sweep.
SOUR:POW:STAR -6; STOP 10
Select a power sweep range between -6 dBm and +10 dBm.
```

**Manual operation:** See "[Start / Stop / Center / Span Frequency \(Power / Time\)](#)" on page 229

**Note:** If the start power entered is greater than the current stop power (`SOURce<Ch>:POWER<PhyPt>:STOP`), the stop power is set to the start power plus the minimum power span (increment) of 0.01 dB.

If the stop power entered is smaller than the current start power (`SOURce<Ch>:POWER<PhyPt>:START`), the start power is set to the stop power minus the minimum power span of 0.01 dB.

### 6.3.17 STATus Commands

The `STATus:...` commands control the status reporting system. Status registers are not reset by \*RST; use \*CLS for this purpose.

|                                                             |     |
|-------------------------------------------------------------|-----|
| <code>STATus:PRESet</code> .....                            | 707 |
| <code>STATus:QUESTionable:CONDition?</code> .....           | 707 |
| <code>STATus:QUESTionable:INTegrity:CONDition?</code> ..... | 707 |

|                                                    |     |
|----------------------------------------------------|-----|
| STATus:QUEStionable:INTEgrity:HARDware:CONDition?  | 707 |
| STATus:QUEStionable:LIMit<Lev>:CONDition?          | 707 |
| STATus:QUEStionable:ENABle                         | 708 |
| STATus:QUEStionable:INTEgrity:ENABle               | 708 |
| STATus:QUEStionable:INTEgrity:HARDware:ENABle      | 708 |
| STATus:QUEStionable:LIMit<Lev>:ENABle              | 708 |
| STATus:QUEStionable:NTRansition                    | 708 |
| STATus:QUEStionable:INTEgrity:NTRansition          | 708 |
| STATus:QUEStionable:INTEgrity:HARDware:NTRansition | 708 |
| STATus:QUEStionable:LIMit<Lev>:NTRansition         | 708 |
| STATus:QUEStionable:PTRansition                    | 709 |
| STATus:QUEStionable:INTEgrity:PTRansition          | 709 |
| STATus:QUEStionable:INTEgrity:HARDware:PTRansition | 709 |
| STATus:QUEStionable:LIMit<Lev>:PTRansition         | 709 |
| STATus:QUEStionable[:EVENTj]?                      | 709 |
| STATus:QUEStionable:INTEgrity[:EVENTj]?            | 709 |
| STATus:QUEStionable:INTEgrity:HARDware[:EVENTj]?   | 709 |
| STATus:QUEStionable:LIMit<Lev>[:EVENTj]?           | 709 |
| STATus:QUEue[:NEXTj]?                              | 709 |

---

### STATus:PRESet

Configures the status reporting system such that device-dependent events are reported at a higher level.

The command affects only the transition filter registers, the ENABle registers, and queue enabling:

- The ENABle parts of the STATus:OPERation and STATus:QUEStionable... registers are set to all 1's.
- The PTRansition parts are set all 1's, the NTRansition parts are set to all 0's, so that only positive transitions in the CONDition part are recognized.

The status reporting system is also affected by other commands, see [Chapter 5.5.5, "Reset Values of the Status Reporting System"](#), on page 392.

**Example:**           STAT:PRESet  
Preset the status registers.

**Usage:**            Event

---

### STATus:QUEStionable:CONDition?

### STATus:QUEStionable:INTEgrity:CONDition?

### STATus:QUEStionable:INTEgrity:HARDware:CONDition?

### STATus:QUEStionable:LIMit<Lev>:CONDition?

Returns the contents of the CONDition part of the QUEStionable... registers. Reading the CONDition registers is nondestructive.

#### Suffix:

<Lev>               Selects one of the two QUEStionable:LIMit registers; see "[STATus:QUEStionable:LIMit<1|2>](#)" on page 386.

**Example:** `STAT:QUES:LIMit:COND?`  
Query the `CONDition` part of the `QUESTionable:LIMit1` register to retrieve the current status of the limit check.

**Usage:** Query only

**STATus:QUESTionable:ENABLE** <BitPattern>  
**STATus:QUESTionable:INTEgrity:ENABLE** <BitPattern>  
**STATus:QUESTionable:INTEgrity:HARDware:ENABLE** <BitPattern>  
**STATus:QUESTionable:LIMit<Lev>:ENABLE** <BitPattern>

Sets the enable mask which allows true conditions in the `EVENT` part of the `QUESTionable...` registers to be reported in the summary bit. If a bit is 1 in the enable register and its associated event bit transitions to true, a positive transition will occur in the summary bit (e.g. bit 10 of the `QUESTionable` register for the `LIMit1` register, bit 0 of the `LIMit1` register for the `LIMit2` register).

See also [Chapter 5.5.1, "Overview of Status Registers"](#), on page 380 and [Chapter 5.5.5, "Reset Values of the Status Reporting System"](#), on page 392.

**Suffix:**  
 <Lev> Selects one of the two `QUESTionable:LIMit` registers; see ["STATus:QUESTionable:LIMit<1|2>"](#) on page 386.

**Parameters:**  
 <BitPattern> Range: 0 to 65535 (decimal representation)  
 \*RST: n/a

**Example:** `STAT:QUES:LIM2:ENAB 6`  
Set bits no. 1 and 2 of the `QUESTionable:LIMit2:ENABLE` register

**STATus:QUESTionable:NTRansition** <BitPattern>  
**STATus:QUESTionable:INTEgrity:NTRansition** <BitPattern>  
**STATus:QUESTionable:INTEgrity:HARDware:NTRansition** <BitPattern>  
**STATus:QUESTionable:LIMit<Lev>:NTRansition** <BitPattern>

Sets the negative transition filters of the `QUESTionable...` status registers. If a bit is set, a 1 to 0 transition in the corresponding bit of the associated condition register causes a 1 to be written in the associated bit of the corresponding event register.

**Suffix:**  
 <Lev> Selects one of the two `QUESTionable:LIMit` registers; see ["STATus:QUESTionable:LIMit<1|2>"](#) on page 386.

**Parameters:**  
 <BitPattern> Range: 0 to 65535 (decimal representation)  
 \*RST: n/a

**Example:** `STAT:QUES:LIM2:NTR 6`  
Set bits no. 1 and 2 of the `QUESTionable:LIMit2:NTRansition` register

**STATus:QUEStionable:PTRansition** <BitPattern>  
**STATus:QUEStionable:INTEgrity:PTRansition** <BitPattern>  
**STATus:QUEStionable:INTEgrity:HARDware:PTRansition** <BitPattern>  
**STATus:QUEStionable:LIMit<Lev>:PTRansition** <BitPattern>

Configures the positive transition filters of the `QUEStionable...` status registers. If a bit is set, a 0 to 1 transition in the corresponding bit of the associated condition register causes a 1 to be written in the associated bit of the corresponding event register.

See also [Chapter 5.5.5, "Reset Values of the Status Reporting System"](#), on page 392.

**Suffix:**

<Lev> Selects one of the two `QUEStionable:LIMit` registers; see "[STATus:QUEStionable:LIMit<1|2>](#)" on page 386.

**Parameters:**

<BitPattern> Range: 0 to 65535 (decimal representation)  
 \*RST: n/a

**Example:**

`STAT:QUES:LIM2:PTR 6`  
 Set bits no. 1 and 2 of the  
`QUEStionable:LIMit2:PTRansition` register

**STATus:QUEStionable[:EVENT]?**  
**STATus:QUEStionable:INTEgrity[:EVENT]?**  
**STATus:QUEStionable:INTEgrity:HARDware[:EVENT]?**  
**STATus:QUEStionable:LIMit<Lev>[:EVENT]?**

These commands return the contents of the `EVENT` parts of the `QUEStionable`, `QUEStionable:INTEgrity`, `QUEStionable:INTEgrity:HARDware`, and `QUEStionable:LIMit<Lev>` status registers. Reading an `EVENT` register clears it.

**Suffix:**

<Lev> Selects one of the two `QUEStionable:LIMit` registers; see "[STATus:QUEStionable:LIMit<1|2>](#)" on page 386.

**Example:**

`STAT:QUES:LIM1?`  
 Query the `EVENT` part of the `QUEStionable:LIMit1` register to check whether an event has occurred since the last reading.

**Usage:**

Query only

**STATus:QUEue[:NEXT]?**

Queries and at the same time deletes the oldest entry in the error queue. Operation is identical to that of `SYSTem:ERRor[:NEXT]?`.

The entry consists of an error number and a short description of the error. Positive error numbers are instrument-dependent. Negative error numbers are reserved by the SCPI standard; see section [Chapter 8, "Error Messages and Troubleshooting"](#), on page 798.

|                 |                                                                                                                |
|-----------------|----------------------------------------------------------------------------------------------------------------|
| <b>Example:</b> | STAT:QUE?<br>Query the oldest entry in the error queue. 0, "No error" is returned if the error queue is empty. |
| <b>Usage:</b>   | Query only                                                                                                     |

### 6.3.18 SYSTEM Commands

The `SYSTEM...` commands provide functions that are not related to instrument performance, such as functions for general housekeeping and functions related to global configurations.

#### 6.3.18.1 SYSTEM:COMMunicate...

The `SYSTEM:COMMunicate...` commands provide remote control settings and configure remote (external) devices controlled by the R&S ZNC/ZND.



For a unidirectional R&S ZND (see [Chapter 3.1.4.2, "R&S ZND: Unidirectional vs. Bidirectional Operation"](#), on page 16) automatic calibration units are not supported and hence the `AKAL` commands are not available.

|                                                                                       |     |
|---------------------------------------------------------------------------------------|-----|
| <code>SYSTEM:COMMunicate:AKAL:CONNECTION</code> .....                                 | 711 |
| <code>SYSTEM:COMMunicate:AKAL:MMEMory[:STATe]</code> .....                            | 711 |
| <code>SYSTEM:COMMunicate:CODEc</code> .....                                           | 711 |
| <code>SYSTEM:COMMunicate:GPIB[:SELF]:ADDRess</code> .....                             | 712 |
| <code>SYSTEM:COMMunicate:GPIB[:SELF]:INIT:WAIT</code> .....                           | 712 |
| <code>SYSTEM:COMMunicate:GPIB[:SELF]:LPORt:ALIGN</code> .....                         | 712 |
| <code>SYSTEM:COMMunicate:GPIB[:SELF]:RTERminator</code> .....                         | 713 |
| <code>SYSTEM:COMMunicate:RDEvice:AKAL:ADDRess</code> .....                            | 713 |
| <code>SYSTEM:COMMunicate:RDEvice:AKAL:ADDRess:ALL?</code> .....                       | 713 |
| <code>SYSTEM:COMMunicate:RDEvice:AKAL:CKIT:CATalog?</code> .....                      | 714 |
| <code>SYSTEM:COMMunicate:RDEvice:AKAL:CKIT:STANdard:CATalog?</code> .....             | 715 |
| <code>SYSTEM:COMMunicate:RDEvice:AKAL:DATE?</code> .....                              | 715 |
| <code>SYSTEM:COMMunicate:RDEvice:AKAL:FRANge?</code> .....                            | 715 |
| <code>SYSTEM:COMMunicate:RDEvice:AKAL:PORtS?</code> .....                             | 716 |
| <code>SYSTEM:COMMunicate:RDEvice:AKAL:PREdUction[:STATe]</code> .....                 | 716 |
| <code>SYSTEM:COMMunicate:RDEvice:AKAL:SDATa?</code> .....                             | 717 |
| <code>SYSTEM:COMMunicate:RDEvice:AKAL:WARMup[:STATe]?</code> .....                    | 718 |
| <code>SYSTEM:COMMunicate:RDEvice:PMETer&lt;Pmtr&gt;:AZERo</code> .....                | 718 |
| <code>SYSTEM:COMMunicate:RDEvice:PMETer:DELeTe</code> .....                           | 718 |
| <code>SYSTEM:COMMunicate:RDEvice:PMETer&lt;Pmtr&gt;:CATalog?</code> .....             | 718 |
| <code>SYSTEM:COMMunicate:RDEvice:PMETer:CONFIgure:AUTO[:STATe]</code> .....           | 719 |
| <code>SYSTEM:COMMunicate:RDEvice:PMETer:COUNT?</code> .....                           | 719 |
| <code>SYSTEM:COMMunicate:RDEvice:PMETer&lt;Pmtr&gt;:DEFine</code> .....               | 719 |
| <code>SYSTEM:COMMunicate:RDEvice:PMETer&lt;Pmtr&gt;:SPCorrecTion[:STATe]</code> ..... | 720 |

**SYSTem:COMMunicate:AKAL:CONNect** <CalStandard>, <Port>[, <SecondPort>]

Connects the selected calibration standard to one or two ports of the active calibration unit (see [SYSTem:COMMunicate:RDEvice:AKAL:ADDRESS](#)).

**Setting parameters:**

|               |                                                                                                                        |
|---------------|------------------------------------------------------------------------------------------------------------------------|
| <CalStandard> | THRough   OPEN   SHORt   MATCh<br>Connected one or two-port standard                                                   |
| <Port>        | Port number of the calibration unit, for one and two-port standards.                                                   |
| <SecondPort>  | Second port number of the calibration unit, for two-port standards (THRough) only, omitted for the one-port standards. |

**Example:** `SYST:COMM:AKAL:CONN THR, 1, 2`  
Connect a trough standard between ports 1 and 2 of the cal unit.

**Usage:** Setting only

**Manual operation:** See "[Apply/Cancel](#)" on page 260

**SYSTem:COMMunicate:AKAL:MMEMory[:STATe]** <Boolean>

Shows or hides the memory of the active calibration unit (see [SYSTem:COMMunicate:RDEvice:AKAL:ADDRESS](#)).

**Setting parameters:**

|           |                                                                                      |
|-----------|--------------------------------------------------------------------------------------|
| <Boolean> | ON - memory is shown in a separate drive.<br>OFF - memory is not shown.<br>*RST: OFF |
|-----------|--------------------------------------------------------------------------------------|

**Example:** `SYST:COMM:AKAL:MMEM ON`  
Show the memory of the active calibration unit.

**Usage:** Setting only

**Manual operation:** See "[Apply/Cancel](#)" on page 260

**SYSTem:COMMunicate:CODEc** <Codec>

Selects the character encoding used at the remote interface. The selected encoding applies to directory and file names, CalKit names, CalUnit characterizations and display titles.

**Parameters:**

|         |                                                                                                           |
|---------|-----------------------------------------------------------------------------------------------------------|
| <Codec> | ASCIi   UTF8   SJIS<br><b>ASCIi:</b> 8-bit ANSI (default)<br><b>UTF8:</b> UTF-8<br><b>SJIS:</b> Shift JIS |
|---------|-----------------------------------------------------------------------------------------------------------|

**Manual operation:** See "[Remote Encoding](#)" on page 333

**SYSTem:COMMunicate:GPIB[:SELF]:ADDRess** <GBIBAddress>

Sets the GPIB address of the analyzer.

**Parameters:**

<GBIBAddress> GPIB address (integer number)  
Range: 0 to 30

**Example:**

```
SYST:COMM:GPIB:ADDR 10
```

Set the GPIB address to 10.

```
*RST; :SYST:COMM:GPIB:ADDR?
```

After a reset, the address is maintained (the response is 10).

**Manual operation:** See ["GPIB Address"](#) on page 346

**SYSTem:COMMunicate:GPIB[:SELF]:INIT:WAIT** <Boolean>

Determines/queries the execution behavior of `INITiate[:IMMEDIATE]` commands (see [Chapter 6.3.9, "INITiate Commands"](#), on page 540).

If set to ON, an automatic `*WAI` is added (see [Chapter 6.2, "Common Commands"](#), on page 400), i.e. the commands execute synchronously.

**Parameters:**

<Boolean> \*RST: OFF

**Manual operation:** See ["Advanced"](#) on page 348

**SYSTem:COMMunicate:GPIB[:SELF]:LPORt:ALIGn** <Boolean>

Configures/queries the logical port creation.

If set to ON, logical ports are aligned and must be set from low to high port, which was the only possibility prior to firmware V1.90. If set to OFF, new ports can be created freely, like in manual operation. See the example below.

**Parameters:**

<Boolean> \*RST: ON

**Example:**

Starting with a 4-port analyzer's default logical port assignment  
L1<-->P1, L2<-->P2, L3<-->P3, L4<-->P4,

the remote command

```
SOUR:LPOR1 1,2
```

by default (`ALIGn=ON`) generates aligned logical ports

```
L1<-->P1&P2, L2<-->P3, L3<-->P4.
```

With `ALIGn=OFF`, the result is

```
L1<-->P1&P2, L3<-->P3, L4<-->P4
```

and L2 does not exist.

**Manual operation:** See ["Advanced"](#) on page 348



**SYSTem:COMMunicate:GPIB[:SELF]:RTERminator** <Terminator>

Sets the receive terminator of the analyzer. The receive terminator indicates the end of a command or a data block.

The receive terminator setting is relevant if block data is transferred to the analyzer (**FORMat** [:**DATA**] **REAL**). In the default setting **LFEoi**, the analyzer recognizes an LF character sequence with or without the EOI control bus message as a receive terminator. An accidental LF in a data block can be recognized as a terminator and cause an interruption of the data transfer.

The EOI setting is especially important if commands are transferred in block data format, because it ensures that the parser for command decoding is activated by the terminator only after the command has been completely transferred. Readout of binary data does not require a change of the receive terminator.

**Parameters:**

<Terminator>            **LFEoi** | **EOI**  
                                  LF character sequence with or without EOI recognized.

**Example:**

```
SYST:COMM:GPIB:RTER EOI
Set the terminator to EOI.
```

**SYSTem:COMMunicate:RDEvice:AKAL:ADDRess** <Address>

Selects one of the USB-connected calibration units for calibration (see commands **SENSe**<Ch>:**CORRection**:**COLLect**:**AUTO**...). This command is not necessary if only one cal unit is connected.

**Parameters:**

<Address>            Name (USB address) of a connected calibration unit (string variable). The names of all connected cal units can be queried using **SYSTem:COMMunicate:RDEvice:AKAL:ADDRess:ALL?**.

**Example:**

```
SYST:COMM:RDEV:AKAL:ADDR:ALL?
Query the names of all connected calibration units.
SYST:COMM:RDEV:AKAL:ADDR 'ZV-Z52::1234'
Select the cal unit named 'ZV-Z52::1234' for calibration.
CORR:COLL:AUTO '', 1, 2, 4
Perform an automatic 3-port TOSM calibration at test ports 1, 2, and 4 using the calibration unit's default calibration kit file and arbitrary test ports of the cal unit.
```

**Manual operation:** See "[Cal Unit](#)" on page 255

**SYSTem:COMMunicate:RDEvice:AKAL:ADDRess:ALL?**

Queries the names (USB addresses) of all connected calibration units.

**Example:**

See **SYSTem:COMMunicate:RDEvice:AKAL:ADDRess**

**Usage:**

Query only

**Manual operation:**

See "[Cal Unit](#)" on page 255

**SYSTem:COMMunicate:RDEvice:AKAL:CKIT:CATalog?**

Queries all characterizations (cal kit files) which are stored on the connected calibration unit, either on the calibration unit's internal (flash) memory or on an SD card inserted at the calibration unit (prefix: "SD"). A possible response is

'Factory, ZN-Z51\_custom, Throughs, SD:test'. The factory characterization is always available; an empty string denotes that no calibration unit is connected.

If several cal units are USB-connected to the analyzer, the command queries the cal unit selected via `SYSTem:COMMunicate:RDEvice:AKAL:ADDRess`.

**Example:**

```
SYST:COMM:RDEV:AKAL:ADDR:ALL?
```

Query the names of all connected calibration units.

```
SYST:COMM:RDEV:AKAL:ADDR 'ZN-Z51::1234'
```

Select the cal unit named 'ZN-Z51::1234'.

```
SYSTem:COMMunicate:RDEvice:AKAL:CKIT:CATalog?
```

Query all characterizations stored on the connected calibration unit.

```
SYSTem:COMMunicate:RDEvice:AKAL:SDATA?
```

```
'My_calkit', OPEN, S11, 1
```

Query the characterization data for the characterization named 'My\_calkit' and an open standard (one-port, port restriction). A characterization with the queried properties must be available on the cal unit.

```
SYSTem:COMMunicate:RDEvice:AKAL:WARMup?
```

Query the warmup status of the calibration unit.

```
SYSTem:COMMunicate:RDEvice:AKAL:DATE? 'Factory'
```

Query the creation date of the factory calibration.

```
SYSTem:COMMunicate:RDEvice:AKAL:FRANge?
```

```
'Factory'
```

Query the frequency range of the factory calibration.

```
SYSTem:COMMunicate:RDEvice:AKAL:PORTs?
```

```
'Factory'
```

Query the port assignment of the factory calibration.

```
SYSTem:COMMunicate:RDEvice:AKAL:CKIT:STANdard:
```

```
CATalog? 'Factory'
```

Query the standards of the factory calibration. Possible response:

```
'MOP (P1) , MSH (P1) , MMT (P1) , MOP (P2) , MSH (P2) ,
```

```
MMT (P2) ' – denotes an Open (m), Short (m) and Match (m)
```

standard at each of the ports 1 and 2.

**Usage:**

Query only

**Manual operation:**

See "[Characterization](#)" on page 256

**SYSTem:COMMunicate:RDEvice:AKAL:CKIT:STANdard:CATalog?**

&lt;CalKitFileName&gt;

Queries all calibration standards of a characterization (cal kit file) that is stored on a connected calibration unit, either on the calibration unit's internal (flash) memory or on an SD card inserted at the calibration unit (if available). The query `SYSTem:COMMunicate:RDEvice:AKAL:CKIT:CATalog?` returns the names of the cal kit files. The factory characterization is always available.

**Query parameters:**

<CalKitFileName> Name of the cal kit file, string parameter.  
 'Factory' denotes the factory characterization, the prefix "SD:" indicates that the characterization is stored on an SD card inserted at the calibration unit.

**Example:** See `SYSTem:COMMunicate:RDEvice:AKAL:CKIT:CATalog?`

**Usage:** Query only

**Manual operation:** See "Characterization" on page 256

**SYSTem:COMMunicate:RDEvice:AKAL:DATE? <CalKitFileName>**

Queries the creation date and time of a cal unit characterization (cal kit file) <CalUnitName>. A possible response is 'Friday, May 26, 2011, 10:13:40'. An empty string is returned if no calibration unit is connected.

If several cal units are USB-connected to the analyzer, the command queries the cal unit selected via `SYSTem:COMMunicate:RDEvice:AKAL:ADDResS`.

**Query parameters:**

<CalKitFileName> String parameter containing the name of a cal unit characterization.  
 'Factory' denotes the factory characterization; an empty string ' ' refers to the last referenced characterization; the prefix "SD:" indicates that the characterization is stored on an SD card inserted at the calibration unit.

**Example:** See `SYSTem:COMMunicate:RDEvice:AKAL:CKIT:CATalog?`

**Usage:** Query only

**Manual operation:** See "Characterization" on page 256

**SYSTem:COMMunicate:RDEvice:AKAL:FRANge? <CalKitFileName>**

Queries the frequency range of a cal unit characterization (cal kit file) <CalUnitName>. The response consists of the start and stop frequencies in Hz, separated by a comma. 0,0 is returned if no calibration unit is connected.

If several cal units are USB-connected to the analyzer, the command queries the cal unit selected via `SYSTem:COMMunicate:RDEvice:AKAL:ADDResS`.

**Query parameters:**

<CalKitFileName> String parameter containing the name of a cal unit characterization.  
 'Factory' denotes the factory characterization; an empty string ' ' denotes the last referenced characterization; the prefix "SD:" indicates that the characterization is stored on an SD card inserted at the calibration unit.

**Example:** See `SYSTem:COMMunicate:RDEvice:AKAL:CKIT:CATalog?`

**Usage:** Query only

**Manual operation:** See "[Characterization](#)" on page 256

**SYSTem:COMMunicate:RDEvice:AKAL:PORTs? <CalKitFileName>**

Queries the number of ports of a cal unit characterization (cal kit file) <CalUnitName>, the assigned connector types, and their gender. A possible response for a two-port calibration is '1,N 50 Ohm,MALE,2,N 50 Ohm,MALE'. An empty string is returned if no calibration unit is connected.

If several cal units are USB-connected to the analyzer, the command queries the cal unit selected via `SYSTem:COMMunicate:RDEvice:AKAL:ADDResS`.

**Query parameters:**

<CalKitFileName> String parameter containing the name of a cal unit characterization.  
 'Factory' denotes the factory characterization; an empty string ' ' denotes the last referenced characterization; the prefix "SD:" indicates that the characterization is stored on an SD card inserted at the calibration unit.

**Example:** See `SYSTem:COMMunicate:RDEvice:AKAL:CKIT:CATalog?`

**Usage:** Query only

**Manual operation:** See "[Characterization](#)" on page 256

**SYSTem:COMMunicate:RDEvice:AKAL:PREduction[:STATe] <Boolean>**

Enables or disables automatic power reduction at all test ports while an automatic calibration using the calibration unit R&S ZV-Zxx is active.

**Parameters:**

<Boolean> Power reduction enabled or disabled.  
 \*RST: ON

**Example:** `SYSTem:COMMunicate:RDEvice:AKAL:PREduction OFF`  
Disable automatic power reduction.

**Manual operation:** See ["Auto Power Reduction for Cal Unit"](#) on page 335

**SYSTem:COMMunicate:RDEvice:AKAL:SDATa?** <CalKitFileName>, <Type>, <SParameter>[, <FirstPort>, <SecondPort>]

Reads the calibration data for a particular standard from a cal unit characterization (cal kit file). If more than one calibration unit is connected, the related one must be selected using `SYSTem:COMMunicate:RDEvice:AKAL:ADDResS`.

**Query parameters:**

|                  |                                                                                                                                                                                                                                                                                                                                                                                                                                                                                                                                                                                                                |
|------------------|----------------------------------------------------------------------------------------------------------------------------------------------------------------------------------------------------------------------------------------------------------------------------------------------------------------------------------------------------------------------------------------------------------------------------------------------------------------------------------------------------------------------------------------------------------------------------------------------------------------|
| <CalKitFileName> | String parameter containing the name of a cal unit characterization.<br>'Factory' denotes the factory characterization; an empty string ' ' denotes the last referenced characterization; the prefix "SD:" indicates that the characterization is stored on an SD card inserted at the calibration unit.                                                                                                                                                                                                                                                                                                       |
| <Type>           | THROUGH   OPEN   SHORT   MATCH   MMTHROUGH   MFTHROUGH   FFTHROUGH   MOPEN   FOPEN   MSHORT   FSHORT   MMTCH   FMTCH<br><br>Standard types; for a description refer to table <a href="#">Standard types and their parameters</a> . The standard types of a particular characterization can be queried via <code>SYSTem:COMMunicate:RDEvice:AKAL:CKIT:STANdard:CATalog?</code> .<br>The factory characterization usually does not contain data for a through standard; therefore a query of the type <code>SYSTem:COMMunicate:RDEvice:AKAL:SDATa? 'Factory', THR, S11, 1, 2</code> results in an error message. |
| <SParameter>     | S11   S12   S21   S22<br><br>S-parameter of the standard, use S11 for one-port standards, one of the four for 2-port standards.                                                                                                                                                                                                                                                                                                                                                                                                                                                                                |
| <FirstPort>      | First port number (sufficient for one-port standards). Port numbers can be omitted if the cal kit data is valid for all ports; see <a href="#">MMEMoRY:LOAD:CKIT:SDATa</a> .                                                                                                                                                                                                                                                                                                                                                                                                                                   |
| <SecondPort>     | Second port number, for two-port standards. Port numbers can be omitted if the cal kit data is valid for all ports.                                                                                                                                                                                                                                                                                                                                                                                                                                                                                            |

**Example:** See `SYSTem:COMMunicate:RDEvice:AKAL:CKIT:CATalog?`

**Usage:** Query only

**Manual operation:** See ["Characterization"](#) on page 256

**SYSTem:COMMunicate:RDEvice:AKAL:WARMup[:STATe]?**

Queries the warmup state of the connected calibration unit R&S ZV\_Z5x. If several cal units are USB-connected to the analyzer, the command queries the cal unit selected via `SYSTem:COMMunicate:RDEvice:AKAL:ADDRESS`.

Possible responses are 1 (true, if the calibration unit has been connected for a sufficient time to reach its operating temperature) or 0 (false). 0 is also returned if no calibration unit is connected.

**Example:** See `SYSTem:COMMunicate:RDEvice:AKAL:CKIT:CATalog?`

**Usage:** Query only

**Manual operation:** See "Characterization" on page 256

**SYSTem:COMMunicate:RDEvice:PMETer<Pmtr>:AZERo**

Starts auto zeroing of the external power meter.

**Suffix:**  
<Pmtr> Number of the configured power meter. Power meters must be numbered in ascending order, starting with 1. If a number is reused, the previous power meter configuration is overwritten. Power meters can be assigned several times so that the number of configured power meters is practically unlimited.

**Example:** See `SYSTem:COMMunicate:RDEvice:PMETer<Pmtr>:DEFine`

**Usage:** Event

**Manual operation:** See "Auto Zero" on page 150

**SYSTem:COMMunicate:RDEvice:PMETer:DELete**

Clears the configuration table for external power meters.

**Example:** See `SYSTem:COMMunicate:RDEvice:PMETer<Pmtr>:DEFine`

**Usage:** Event

**Manual operation:** See "Configured Devices" on page 352

**SYSTem:COMMunicate:RDEvice:PMETer<Pmtr>:CATalog?**

Queries the numbers of all configured external power meters. The response is a string containing a comma-separated list of power meter numbers.

**Suffix:**  
<Pmtr> Number of the configured power meter. This suffix is ignored; the command affects all power meters.

**Example:**

```

SYST:COMM:RDEV:PMET1:DEF 'USB Power Meter 1',
'NRP-Z55', 'usb', '100045'
SYST:COMM:RDEV:PMET2:DEF 'USB Power Meter 2',
'NRP-Z55', 'usb', '100046'

```

Configure two R&S NRP power meters as external power meter no. 1 and 2, assigning names and serial numbers.

```

SYST:COMM:RDEV:PMET1:CAT?

```

Query the power meter numbers. The response is '1, 2'.

```

SYST:COMM:RDEV:PMET1:COUN?

```

Query the number of configured power meters. The response is 2.

**Usage:** Query only

**Manual operation:** See ["Configured Devices"](#) on page 352

---

#### **SYSTem:COMMunicate:RDEvice:PMETer:CONFigure:AUTO[:STATe] <Boolean>**

Enables or disables "Auto Config NRP-Zxx". If the function is enabled, the analyzer automatically configures all power meters detected at any of the USB ports as Pmtr 1, Pmtr2, ...

**Parameters:**

<Boolean> ON | OFF - enable or disable "Auto Config NRP-Zxx".

**Example:** See [SYSTem:COMMunicate:RDEvice:PMETer<Pmtr>:DEFine](#)

**Manual operation:** See ["Auto Config NRP-Zxx"](#) on page 354

---

#### **SYSTem:COMMunicate:RDEvice:PMETer:COUNT?**

Queries the number of configured external power meters. The result is an integer number of power meters.

**Example:** See [SYSTem:COMMunicate:RDEvice:PMETer<Pmtr>:CATalog?](#)

**Usage:** Query only

**Manual operation:** See ["Configured Devices"](#) on page 352

---

#### **SYSTem:COMMunicate:RDEvice:PMETer<Pmtr>:DEFine <PmtrName>, <Driver>, <Interface>, <Address>**

Configures an external power meter and adds it to the list of available power meters.

**Suffix:**

<Pmtr> Number of the configured power meter. Power meters must be numbered in ascending order, starting with 1. If a number is re-used, the previous power meter configuration is overwritten. Power meters can be assigned several times so that the number of configured power meters is practically unlimited.

**Parameters:**

|             |                                                                                                                                                                                                                                                                                                                                                                                                                                                                                                                                                                                                                                                                |
|-------------|----------------------------------------------------------------------------------------------------------------------------------------------------------------------------------------------------------------------------------------------------------------------------------------------------------------------------------------------------------------------------------------------------------------------------------------------------------------------------------------------------------------------------------------------------------------------------------------------------------------------------------------------------------------|
| <PmtrName>  | Name of the external power meter (string parameter). An empty string means that no particular name is assigned to the power meter.                                                                                                                                                                                                                                                                                                                                                                                                                                                                                                                             |
| <Driver>    | Power meter type (string parameter). The power meter type is identical with the name of the power meter driver file (*.pwm) stored in the <code>resources\extdev</code> subdirectory of the analyzer's program directory. Type the driver file name as shown in the "Add External Generator" dialog, i.e. without the file extension ".pwm" (example: use 'NRVD', if the corresponding driver file name is <code>NRVD.pwm</code> ).<br><b>Alternative:</b> The '<Driver>' string may also contain the power meter driver file name with its complete path, e.g. <code>'C:\Program Files\Rohde&amp;Schwarz\Network Analyzer\resources\extdev\nrvd.pwm'</code> . |
| <Interface> | Interface type (string parameter): 'GPIB0', 'VXI-11', 'socket', 'other', 'USB' (for the supported USB devices) ...                                                                                                                                                                                                                                                                                                                                                                                                                                                                                                                                             |
| <Address>   | Interface address (string parameter), depending on the interface type. See <a href="#">Table 4-3</a>                                                                                                                                                                                                                                                                                                                                                                                                                                                                                                                                                           |

**Example:**

```
SYST:COMM:RDEV:PMET:CONF:AUTO OFF
```

Disables "Auto Config NRP-Zxx" (if it was enabled previously).

```
SYST:COMM:RDEV:PMET1:DEF 'USB Power Meter',  
'NRP-Z55', 'usb', '100045'
```

Configure an R&S NRP power meter as external power meter no. 1, assigning the name "USB Power Meter" and a serial number 100045.

```
SYST:COMM:RDEV:PMET:DEL
```

Clear the power meter configuration table.

```
SYST:COMM:RDEV:PMET:DEF?
```

Query the power meter configuration. The analyzer returns an error message because the power meter no. 1 is no longer configured.

**Manual operation:** See "[Configured Devices](#)" on page 352

---

**SYSTem:COMMunicate:RDEvice:PMETer<Pmtr>:SPCorrection[:STATe]**  
<Boolean>

Gets/sets the state of the built-in S-parameter correction that is available on certain R&S®NRP-Z power sensors. See Application Note [1GP70: Using S-Parameters with R&S®NRP-Z Power Sensors](#) for background information.

Note that this state is persistently stored on the power sensor (and NOT on the R&S ZNC/ZND).

**Suffix:**

<Pmtr> Number of the configured power meter.



**Parameters:**

&lt;Boolean&gt; ON | OFF

**Manual operation:** See "[Deembed Two-Port \(All Channels\)](#)" on page 354**6.3.18.2 SYSTem... (Contd.)**

The following SYSTem... commands provide general instrument configurations.

|                                      |     |
|--------------------------------------|-----|
| SYSTem:CORREction:WIZard[:IMMEDIATE] | 722 |
| SYSTem:DATE                          | 722 |
| SYSTem:DFPPrint?                     | 722 |
| SYSTem:DISPlay:BAR:HKEY[:STATe]      | 722 |
| SYSTem:DISPlay:BAR:MENU[:STATe]      | 722 |
| SYSTem:DISPlay:BAR:STATus[:STATe]    | 722 |
| SYSTem:DISPlay:BAR:STOols[:STATe]    | 722 |
| SYSTem:DISPlay:BAR:TITLe[:STATe]     | 723 |
| SYSTem:DISPlay:BAR:TOOLs[:STATe]     | 723 |
| SYSTem:DISPlay:COLor                 | 723 |
| SYSTem:DISPlay:UPDate                | 723 |
| SYSTem:ERRor:ALL?                    | 724 |
| SYSTem:ERRor:DISPlay:STATe           | 724 |
| SYSTem:ERRor:DISPlay:INFO            | 724 |
| SYSTem:ERRor:DISPlay:WARNings        | 724 |
| SYSTem:ERRor:DISPlay:ERRor           | 724 |
| SYSTem:ERRor:DISPlay[:REMote]        | 725 |
| SYSTem:ERRor[:NEXT]?                 | 725 |
| SYSTem:FIRMware:UPDate               | 726 |
| SYSTem:FPReset                       | 726 |
| SYSTem:FREQuency?                    | 726 |
| SYSTem:IDENtify:FACTory              | 727 |
| SYSTem:IDENtify[:STRing]             | 727 |
| SYSTem:KLOCK                         | 727 |
| SYSTem:LANGuage                      | 727 |
| SYSTem:LOGGing:REMote[:STATe]        | 728 |
| SYSTem:OPTions:FACTory               | 728 |
| SYSTem:OPTions[:STRing]              | 728 |
| SYSTem:PRESet:REMote[:STATe]         | 729 |
| SYSTem:PASSword[:CENable]            | 729 |
| SYSTem:PRESet:SCOPE                  | 729 |
| SYSTem:PRESet:USER:NAME              | 730 |
| SYSTem:PRESet:USER[:STATe]           | 730 |
| SYSTem:PRESet:USER:CAL               | 730 |
| SYSTem:PRESet[:DUMMy]                | 731 |
| SYSTem:SETTings:UPDate               | 731 |
| SYSTem:SHUTdown                      | 732 |
| SYSTem:SOUNd:ALARm[:STATe]           | 732 |
| SYSTem:SOUNd:STATus[:STATe]          | 732 |
| SYSTem:TIME                          | 733 |
| SYSTem:TSLock                        | 733 |

|                                                                 |     |
|-----------------------------------------------------------------|-----|
| <a href="#">SYSTem:USER:KEY</a> .....                           | 733 |
| <a href="#">SYSTem:VERsion?</a> .....                           | 734 |
| <a href="#">SYSTem:DISPlay:DIALogs:SETup:MCAL[:STATe]</a> ..... | 734 |
| <a href="#">SYSTem:SMATrix:OPTimization</a> .....               | 734 |

---

### **SYSTem:CORRection:WIZard[:IMMediate]** <Dialogs>

Keysight-compatible command to open the [Calibration > Start Cal](#) softtool tab or the [Calibration Kits Dialog](#).

**Tip:** When working with the [Chapter 5.1.2, "GPIB Explorer"](#), on page 360, switch to raw mode ("Options > Raw mode" in the IECWIN32 GUI) before executing this command.

#### **Setting parameters:**

<Dialogs>                    MAIN | CKIT  
                                   MAIN: open the "Calibration > Start Cal" softtool tab  
                                   CKIT: open the "Calibration Kits" dialog

**Usage:**                      Setting only

---

### **SYSTem:DATE** <Year>, <Month>, <Day>

The command queries or defines the instrument's current date setting.

The setting command requires administrator rights; refer to chapter "Administrative Tasks" in the Getting Started guide.

#### **Parameters:**

<Year>                        Year, four-digit number  
 <Month>                      Month, two-digit number, 01 (for January) to 12 (for December)  
 <Day>                         Day, two-digit number, 01 to the number of days in the month

**Example:**                    `SYST:DATE?`  
 Response: 2012,05,01 - it is the 1st of May, 2012.

---

### **SYSTem:DFPRint?**

Queries the device footprint. The device footprint contains detailed information about the instrument and is mostly used for service purposes.

**Usage:**                      Query only

**Manual operation:**    See ["Save... / Print... / Save Report"](#) on page 342

---

**SYSTem:DISPlay:BAR:HKEY[:STATe]** <Boolean>  
**SYSTem:DISPlay:BAR:MENU[:STATe]** <Boolean>  
**SYSTem:DISPlay:BAR:STATus[:STATe]** <Boolean>  
**SYSTem:DISPlay:BAR:STOols[:STATe]** <Boolean>

**SYSTem:DISPlay:BAR:TITLe[:STATe]** <Boolean>

**SYSTem:DISPlay:BAR:TOOLs[:STATe]** <Boolean>

Displays or hides the hardkey panel (HKEY), the menu bar below the diagram area (MENU), the status bar below the diagram area (STATUS), the softtool panel (STOOLS), the title bar of the main VNA application window (TITLE), and the toolbar above the diagram area (TOOLS).

**Parameters:**

<Boolean>            ON | OFF  
 Display or hide the information elements.

**Example:**

```
SYSTem:DISPlay:BAR:TOOLs ON; STOOLs ON; STATus
ON
Display the toolbar, softtool panel, and status bar.
SYSTem:DISPlay:BAR:TITLe OFF; HKEY OFF; MENU
OFF
Hide the title bar, hardkey bar, and menu bar.
```

**SYSTem:DISPlay:COLor** <ColorScheme>

Selects the color scheme for all diagram areas in the active recall set.

**Parameters:**

<ColorScheme>        DBACKground | LBACKground | BWLStyles | BWSolid  
 DBACKground - dark background  
 LBACKground - light background  
 BWLStyles - black and white line styles  
 BWSolid - black and white solid

**Example:**

```
SYST:DISP:COL LBAC
Independent of the selected color scheme, hardcopies are
always generated with the light background scheme.
```

**Manual operation:** See "[Color Scheme](#)" on page 326

**SYSTem:DISPlay:UPDate** <Activate>

Switches the display on or off while the analyzer is in the remote state. The command has no effect while the analyzer is in the local operating state.

**Tip:** Switching off the display speeds up the measurement. This command may have an impact on the update of trace and channel settings; see [SYSTem:SETTings:UPDate](#).

**Parameters:**

<Activate> ON | OFF - switch the display on or off. If the display is switched on, the analyzer shows the diagrams and traces like in manual control.

ONCE - switch the display on and show the current trace. This parameter can be used for occasional checks of the measurement results or settings. The measurement is continued, however, the measurement results are not updated. Compared to the ON setting, ONCE does not slow down the measurement speed.

**Example:**

```
SYST:DISP:UPD ON
```

Switch the display on to view the traces and diagrams.

**SYSTem:ERRor:ALL?**

Queries and at the same time deletes all entries in the error queue.

The entries consist of an error number and a short description of the error. Positive error numbers are instrument-dependent. Negative error numbers are reserved by the SCPI standard; see section [Error Messages and Troubleshooting](#).

**Example:**

```
SYST:ERR:ALL?
```

Query all entries in the error queue. 0, "No error" is returned if the error queue is empty.

**Usage:**

Query only

**SYSTem:ERRor:DISPlay:STATe <Boolean>**

Globally defines whether instrument events shall be indicated by information popups.

Display of popups can be limited to certain event types using commands [SYSTem:ERRor:DISPlay:INFO](#), [SYSTem:ERRor:DISPlay:WARNings](#), [SYSTem:ERRor:DISPlay:ERRor](#), and [SYSTem:ERRor:DISPlay\[:REMOte\]](#).

**Parameters:**

<Boolean> ON | OFF - globally enable or disable the display of information popups

\*RST: ON

**Example:**

See [SYSTem:ERRor:DISPlay:ERRor](#) and [SYSTem:ERRor:DISPlay\[:REMOte\]](#).

**Manual operation:** See "[Show Instrument Messages](#)" on page 337

**SYSTem:ERRor:DISPlay:INFO <Boolean>****SYSTem:ERRor:DISPlay:WARNings <Boolean>****SYSTem:ERRor:DISPlay:ERRor <Boolean>**

Selectively disables or enables the display of information popups for the related event type (Information, Warning, System Error).

**Note** that the display of information popups can be globally disabled/enabled using `SYSTem:ERRor:DISPlay:STATe` OFF/ON.

**Parameters:**

<Boolean> ON | OFF - enable/disable display of information popups for the related event type  
\*RST: ON

**Example:**

```
SYST:ERR:DISP:STATe ON; ERR ON; WARN:OFF; INFO OFF
```

Display information popups for system errors, but not for warnings and information messages.

**Manual operation:** See ["Show Info/Warning/Error Messages"](#) on page 337

**SYSTem:ERRor:DISPlay[:REMote]** <Boolean>

Disables or enables the display of information popups for remote control errors. These popups appear at the bottom of the remote screen and the manual screen.

**Note**

- Display of information popups can be globally disabled/enabled using `SYSTem:ERRor:DISPlay:STATe` OFF/ON
- For SCPI error -113, `Undefined header no tooltip` is displayed

**Parameters:**

<Boolean> ON | OFF - enable/disable display of information popups for remote control errors  
\*RST: ON

**Example:**

```
SYST:ERR:DISP:STATe ON; REM ON
```

Switch the display of information popups for remote command errors on.

```
FREQ:STAR -1
```

Generate a Remote Error: -222, "Data out of range; ..." tooltip.

**Manual operation:** See ["Show Remote Error Info Messages"](#) on page 338

**SYSTem:ERRor[:NEXT]?**

Queries and at the same time deletes the oldest entry in the error queue. Operation is identical to that of `STATus:QUEue[:NEXT]?`

The entry consists of an error number and a short description of the error. Positive error numbers are instrument-dependent. Negative error numbers are reserved by the SCPI standard; see section [Error Messages and Troubleshooting](#).

**Example:**

```
SYST:ERR?
```

Query the oldest entry in the error queue. 0, "No error" is returned if the error queue is empty.

**Usage:** Query only

---

### **SYSTem:FIRMware:UPDate** <NWASetupFile>

Installs a firmware version stored in a VNA setup file (\*.msi) on the analyzer. The installation is automatic and does not require any further action.

#### **Setting parameters:**

<NWASetupFile> String variable for the name and directory of a VNA setup file (\*.msi).

#### **Example:**

```
SYST:FIRM:UPD 'C:
\Users\Public\Setup\ZNBC_01.40.msi'
```

Install the firmware version V1.40 from the setup file stored in the public directory of the analyzer's internal hard disk.

**Usage:** Setting only

---

### **SYSTem:FPReset**

Performs a factory preset of all instrument settings (i.e. all open recall sets) or of the active recall set, depending on the `SYSTem:PRESet:SCOPE` settings, and deletes channel 1 in the active recall set. As a result, the active recall set contains no channels, traces, and diagram areas.

#### **Example:**

```
SYST:PRE:SCOP SING
```

Define the scope of a preset: the active recall set is reset only.

```
SYST:FPR
```

Reset the parameters of the current recall set and delete channel 1.

**Usage:** Event

---

### **SYSTem:FREQuency?** <MinMax>

Queries the minimum and maximum frequency of the network analyzer. For an overview refer to the tables at the beginning of [Chapter 6.3.15.8](#), "[SENSe:]FREQuency...", on page 643.

**Tip:** In contrast to `[SENSe<Ch>:]FREQuency:START?` and the other sweep range commands, `SYSTem:FREQuency?` can be used in all sweep modes.

#### **Query parameters:**

<MinMax> MINimum | MAXimum

#### **Return values:**

<Frequency> MINimum | MAXimum  
Return minimum or maximum frequency.

**Example:** See `[SENSe<Ch>:]FREQuency:CENTer`

**Usage:** Query only

**Manual operation:** See ["Start / Stop / Center / Span Frequency \(Power / Time\)"](#) on page 229

---

### SYSTem:IDENtify:FACTory

Resets the response to the \*IDN? query to the factory default value. This command overwrites a user-defined identification string; see example.

**Example:**

```
SYSTem:IDENtify:STRing 'MyDevice'; *IDN?
Define an identity string. The response is MyDevice.
SYSTem:IDENtify:FACTory; *IDN?
Re-activate the factory setting. The response is
Rohde-Schwarz,<instrument type>-<ports>,<stock
no.><serial no.>,<firmware version>.
```

**Usage:** Event

**Manual operation:** See ["Define \\*IDN? + \\*OPT?"](#) on page 347

---

### SYSTem:IDENtify[:STRing] <InstId>

Defines an identity string for the network analyzer. The query is equivalent to \*IDN?.

**Parameters:**  
<InstId> String parameter containing the instrument identity

**Example:** See [SYSTem:IDENtify:FACTory](#)

**Manual operation:** See ["Define \\*IDN? + \\*OPT?"](#) on page 347

---

### SYSTem:KLOCK <Boolean>

Locks or unlocks the local controls of the analyzer. This includes the front panel keys, the keyboard, or other local interfaces.

**Parameters:**  
<Boolean> ON | OFF - lock or unlock the local keys.  
\*RST: OFF

**Example:**

```
SYST:KLOCK ON
Lock the local keys.
```

---

### SYSTem:LANGuage <Language>

Specifies the remote language for the analyzer.

**Parameters:**

&lt;Language&gt;

Command syntax for the analyzer, string variable:  
 'SCPI' – R&S ZNC/ZND-specific command set: the analyzer supports all commands described in this documentation.  
 'ZVR' | 'ZVABT' – compatibility with network analyzers of the R&S ZVR and R&S ZVA/B/T families.  
 'PNA' | 'HP8510' | 'HP8720' | 'HP8753' – compatibility with network analyzers from other manufacturers.  
 \*RST: n/a - a reset does not affect the language setting. The factory setting is SCPI.

**Example:**

```
SYST:LANG 'PNA'
```

Select a PNA-compatible command set.

**Manual operation:** See "[Remote Language](#)" on page 346

**SYSTem:LOGGing:REMOte[:STATe]** <Boolean>

Enables logging of all remote control commands transferred to the analyzer.

**Parameters:**

&lt;Boolean&gt;

ON – command sequence stored to file  
 C:\Users\Public\Documents\Rohde-Schwarz\Vna\RemoteLog\VNARemote.log.  
 OFF – command sequence not logged.

**Example:**

```
SYST:LOGG:REM ON
```

Enable remote logging. The log file 'C:\Users\Public\Documents\Rohde-Schwarz\Vna\RemoteLog\VNARemote.log' is fixed and does not have to be specified.

**SYSTem:OPTions:FACTory**

Resets the response to the \*OPT? query to the factory default value. This command overwrites a user-defined option string; see example.

**Example:**

```
SYSTem:OPTions:STRing 'MyOptions'; *OPT?
```

Define an identity string. The response is MyOptions.

```
SYSTem:OPTions:FACTory; *OPT?
```

Re-activate the factory setting. The analyzer returns a comma-separated list of software and hardware options.

**Usage:**

Event

**Manual operation:** See "[Define \\*IDN? + \\*OPT?](#)" on page 347

**SYSTem:OPTions[:STRing]** <Options>

Defines an option string for the network analyzer. The query is equivalent to \*OPT?.



**Parameters:**

<Options> String parameter containing the available options

**Example:**

See `SYSTem:OPTions:FACTory`

**Manual operation:** See "Define \*IDN? + \*OPT?" on page 347

**SYSTem:PRESet:REMOte[:STATe]** <arg0>

Defines the behavior of the \*RST and `SYSTem:PRESet[:DUMMy]` commands.

- **Off (default):** \*RST and `SYSTem:PRESet` restore the factory preset settings.
- **On:** If a valid user preset file is available, \*RST and `SYSTem:PRESet` restore the user-defined settings.

**Parameters:**

<arg0>

**Manual operation:** See "Remote Preset Configuration" on page 334

**SYSTem:PASSword[:CENable]** <Password>

Sends a password to the analyzer enabling a class of service functions to function (Command ENable). Service functions are activated with the commands of the `DIAGnostic...` system and should be used by a R&S service representative only.

**Setting parameters:**

<Password> Case-sensitive string variable. Sending an invalid password generates error -221, (settings conflict).

**Example:**

`SYST:PASS "XXXX"`  
Enter password.

**Usage:**

Setting only

**Manual operation:** See "Password" on page 345

**SYSTem:PRESet:SCOPE** <Scope>

Specifies whether a preset (`SYSTem:PRESet[:DUMMy]`; \*RST) affects the active recall set only or all open recall sets.

**Parameters:**

<Scope>

ALL | SINGle

ALL – all open recall sets are deleted and the recall set "Set1" is created with default trace and channel settings.

SINGle – the settings of the active setup are reset; the name of the active setup and the parameters of all other setups remain unchanged.

**Example:**

See `SYSTem:PRESet[:DUMMy]`

**Manual operation:** See "Preset Scope" on page 334

**SYSTem:PRESet:USER:NAME** <RecallSetFile>

Specifies the name of a recall set file (.znx) to be used for a user-defined preset.

**Parameters:**

<RecallSetFile> String parameter to specify the name and directory of the recall set file to be loaded. The default extension (manual control) for recall set files is \*.znx, although other extensions are allowed. If no path is specified the analyzer searches the default directory (subdirectory ...RecallSets)

**Example:** See [SYSTem:PRESet:USER\[:STATe\]](#)

**Manual operation:** See ["Preset Configuration"](#) on page 334

**SYSTem:PRESet:USER[:STATe]** <Boolean>

Selects a factory preset or a user-defined preset.

**Note:** The user-defined preset can be initiated using "System > Preset" (manual control) or `MMEMoRY:LOAD:STATe`. `*RST` and `SYSTem:PRESet[:DUMMy]` always initiate a factory preset.

**Parameters:**

<Boolean> OFF - user-defined preset switched off (factory preset is used).  
ON - user-defined preset switched on.

**Example:**

```
SYST:PRE:USER ON
Enable a user-defined preset.
SYST:PRE:USER:NAME 'C:\Users\Public
\Documents\Rohde-Schwarz\Vna\RecallSets\Setup_2.znx'
Select a setup file for the user-defined preset.
Press PRESET (manual control) or use
MME:LOAD:STAT 1, 'C:\Users\Public\Documents
\Rohde-Schwarz\Vna\RecallSets\Setup_2.znx'.
```

**Manual operation:** See ["Preset Configuration"](#) on page 334

**SYSTem:PRESet:USER:CAL** <PresetUserCal>

Selects a calibration from the calibration pool that shall be restored during a user-defined preset.

The corresponding cal group file (<PresetUserCal>.cal) must be available in the cal pool directory

C:\Users\Public\Documents\Rohde-Schwarz\Vna\Calibration\Data\.

**Parameters:**

<PresetUserCal> Name of the cal group (i.e. the name of the cal group file without path and extension).  
Use the empty string to restore the default behavior (no preset user cal).

**Example:**

```
MMEMORY:STORE:CORRection 1, 'Ref11
Trans123.cal'
Adds the active user calibration to the memory pool
SYSTem:PRESet:USER:CAL 'Ref11 Trans123'
Sets the newly created cal pool member as the preset user cal.
SYSTem:PRESet:USER:CAL?
Queries for the preset user cal. Returns 'Ref11 Trans123'
SYSTem:PRESet:USER:CAL ''
Restores the default behaviour of the instrument: no preset user
cal.
```

**Manual operation:** See "[Preset User Cal](#)" on page 296

---

### SYSTem:PRESet[:DUMMy]

Performs a factory preset of all instrument settings (i.e. all open recall sets) or of the active recall set, depending on the `SYSTem:PRESet:SCOPE` settings. The command is equivalent to `*RST` and to the action of the PRESET key on the front panel.

**Note:** If a user-defined preset is active (`SYSTem:PRESet:USER[:STATE]ON`), the PRESET key initiates a user-defined preset, while `SYSTem:PRESet[:DUMMy]` and `*RST` still activate the factory preset. If "Align \*RST to User Defined Preset" is selected in the "System Configuration > Presets" dialog and a valid user preset file is available, `*RST` and `SYSTem:PRESet[:DUMMy]` also restore the user-defined settings.

**Example:**

```
SYST:PRESet:SCOPE SING
Define the scope of a preset: the active recall set is reset only.
SYST:PRESet
Reset the parameters of the current recall set.
```

**Manual operation:** See "[Preset](#)" on page 355

---

### SYSTem:SETTings:UPDate <Activate>

Initiates an immediate update of the channel or trace settings.

The command has an effect if the analyzer operates in single sweep mode (`INITiate<Ch>:CONTInuousOFF`) and if the display update is switched off (`SYSTem:DISPlay:UPDateOFF`). In this scenario, a change of the channel or trace settings is usually not taken into account immediately. The analyzer waits until the end of the current sweep sequence and changes all settings made during the last sweep period when the next single sweep sequence is initiated. Several settings can be made en bloc, which generally saves time.

`SYSTem:SETTings:UPDate ONCE` causes the analyzer to apply the settings at once without waiting for the end of the current single sweep sequence. The command has no effect in continuous sweep mode or if the display update is switched on.

The settings are also updated when the continuous sweep mode is activated (`INITiate<Ch>:CONTInuousON`).

**Setting parameters:**

<Activate> ONCE  
Causes an immediate update of the settings.

**Example:**

```
INIT:CONT OFF
Activate single sweep mode.
SYST:SETT:UPD ONCE
Update the settings made during the current single sweep
period.
```

**Usage:** Setting only

**SYSTem:SHUTdown** [<Unit>]

Performs a shutdown or restart of the FW or OS.

If the optional parameter <Unit> is omitted, Windows is shutdown after a time-out period of 10 seconds.

**Setting parameters:**

<Unit> HALT | REBoot | ABORt | CLOSe | REStArt

**HALT**  
Windows is shutdown after a time-out period of 20 seconds

**REBoot**  
Windows is restarted after a time-out period of 20 seconds

**ABORt**  
Abort a Windows shutdown/restart. This can only be used during the time-out period.

**CLOSe**  
Close the firmware.

**REStArt**  
Restart the firmware.

**Example:**

```
SYST:SHUT
Switch the analyzer to standby state.
```

**Usage:** Setting only

**SYSTem:SOUNd:ALARm[:STATe]** <Boolean>

**SYSTem:SOUNd:STATus[:STATe]** <Boolean>

These commands switch alarm or status sounds on or off.

**Parameters:**

<Boolean> ON | OFF  
\*RST: ON

**Example:**

```
SYST:SOUN:ALAR OFF; STAT OFF
Switch alarm and status sounds off.
```

**Manual operation:** See ["Instrument Messages / Sounds / Transparent Info Fields / Show Sweep Symbols"](#) on page 336

**SYSTem:TIME** <Hours>, <Minutes>, <Seconds>

The command queries or defines the instrument's current time setting.

The setting command requires administrator rights; refer to chapter "Administrative Tasks" in the Getting Started guide.

**Parameters:**

|           |        |        |
|-----------|--------|--------|
| <Hours>   | Range: | 0...23 |
| <Minutes> | Range: | 0...59 |
| <Seconds> | Range: | 0...59 |

**Example:**

```
SYST:TIME?
Response: 12, 0, 0 - it is precisely 12 pm.
```

**SYSTem:TSLock** <Type>

Locks the touchscreen functionality of the R&S ZNC/ZND, e.g. in order to prevent inadvertent entries during remote control.

**Parameters:**

|        |                                                                                                                                                                                                                           |
|--------|---------------------------------------------------------------------------------------------------------------------------------------------------------------------------------------------------------------------------|
| <Type> | OFF   DIAGrams   SCReen                                                                                                                                                                                                   |
|        | OFF – touchscreen (e.g. the remote screen) remains active. You can use the buttons in "Remote" softtool panels. If you switch back to manual control, the drag and drop functions (e.g. for markers) are still available. |
|        | DIAGrams – lock the drag and drop functions in diagrams .                                                                                                                                                                 |
|        | SCReen – lock the entire screen including the remote screen buttons.                                                                                                                                                      |
| *RST:  | n/a (*RST does not affect the tochsreen lock setting).                                                                                                                                                                    |

**Example:**

```
SYSTem:TSLock SCReen
Lock the entire screen.
```

**SYSTem:USER:KEY** <Key>[, <Label>]

Labels a user-defined key in the remote display. In the query form the command returns whether or not a user-defined key was tapped.

**Parameters:**

|         |                                                                                                                                                                          |
|---------|--------------------------------------------------------------------------------------------------------------------------------------------------------------------------|
| <Key>   | Number of the user key<br>0 – Delete all user keys and restore the default keys ("Go to Local", "Display Off").<br>1 to 8 – User key numbers<br>Range: 0 to 8<br>*RST: 0 |
| <Label> | Label for user key no. 1 to 8 (string variable)                                                                                                                          |

**Example:**

```
SYST:USER:KEY 1, 'User S11'
```

Define a user key no. 1 labeled S11. The user key is only labeled, no functionality is assigned.

```
SYST:USER:KEY? 1
```

Query the label. The response is 1, 'User S11'.

```
SYST:USER:KEY?
```

Query the user action. The query returns 0, '', indicating that no user key has been tapped. If you tap the user softkey no. 1, the response is 1, 'User S11'. Moreover, the ESR bit no. 6 (User Request) is set.

```
SYST:USER:KEY 0
```

Delete the user key and restore the default keys.

---

#### SYSTem:VERSion?

Returns the SCPI version number to which the analyzer complies. The analyzer complies to the final SCPI version 1999.0

**Example:**

```
SYST:VERS?
```

Query the SCPI version. The response is 1999.0.

**Usage:** Query only

---

#### SYSTem:DISPlay:DIALogs:SETup:MCAL[:STATE] <Boolean>

Enables/disables multiple calibrations in the calibration wizard.

**Parameters:**  
<Boolean>

---

#### SYSTem:SMATrix:OPTimization <Unit>

Sets/gets the switch matrix route selection algorithm.

**Parameters:**  
<Unit>

SPEed | PRECision

SPEed – Optimizes measurement speed by minimizing the total number of switching procedures. This is highly recommended for matrices with mechanical switches.

PRECision – Optimizes measurement precision by always using best possible routes (according to matrix-specific route prioritization).

**Firmware/Software:** V1.70

### 6.3.19 TRACe Commands

The TRACe . . . commands handle active trace data and trace data stored in the analyzer's internal memory.



### Trace data formats

Trace data is transferred in either ASCII or block data (REAL) format, depending on the `FORMat[:DATA]` setting. If the block data format is used, it is recommended to select EOI as receive terminator (`SYSTem:COMMunicate:GPIB[:SELF]:RTERminator EOI`).

The commands in the TRACe... menu use the following ZVR-compatible parameters to specify traces:

**Table 6-10: Reserved Trace Names**

| Parameter                                                                    | Meaning                                                                                                                         | Used in                                                                                                                                                                                                         |
|------------------------------------------------------------------------------|---------------------------------------------------------------------------------------------------------------------------------|-----------------------------------------------------------------------------------------------------------------------------------------------------------------------------------------------------------------|
| CH1DATA<br>CH2DATA<br>CH3DATA<br>CH4DATA                                     | Active data trace of channels 1 to 4                                                                                            | <code>TRACe:COPI</code><br><code>TRACe[:DATA]:STIMulus[:ALL]?</code><br><code>TRACe[:DATA][:RESPonse][:ALL]?</code><br><code>CALCulate&lt;Chn&gt;:MATH[:EXPRession][:DEFine]</code>                             |
| CH1MEM<br>CH2MEM<br>CH3MEM<br>CH4MEM                                         | Active memory trace associated to the active data trace CH1DATA, CH2DATA, CH3DATA, CH4DATA, respectively.                       | <code>TRACe[:DATA]:STIMulus[:ALL]?</code><br><code>TRACe[:DATA][:RESPonse][:ALL]?</code>                                                                                                                        |
| IMPLied                                                                      | Active data trace, addressed with <Chn>                                                                                         | <code>CALCulate&lt;Chn&gt;:MATH[:EXPRession][:DEFine]</code>                                                                                                                                                    |
| CHMem                                                                        | Active memory trace assigned to the IMPLied trace                                                                               | <code>CALCulate&lt;Chn&gt;:MATH[:EXPRession][:DEFine]</code>                                                                                                                                                    |
| MDATA1<br>MDATA2<br>MDATA3<br>MDATA4<br>MDATA5<br>MDATA6<br>MDATA7<br>MDATA8 | Memory trace named Mem<n> [Trc<m>]. The trace name is unique because <n> counts all data and memory traces in the active setup. | <code>TRACe:CLEar</code><br><code>TRACe:COPI</code><br><code>TRACe[:DATA]:STIMulus[:ALL]?</code><br><code>TRACe[:DATA][:RESPonse][:ALL]?</code><br><code>CALCulate&lt;Chn&gt;:MATH[:EXPRession][:DEFine]</code> |

### **TRACe:COPI** <MemTraceName>, <DataTraceName>

Copies a data trace to a memory trace. The trace to be copied can be specified by two alternative methods:

- As the active data trace of channels 1 to 4 (CH1DATA, CH2DATA, CH3DATA, CH4DATA). If a mathematical trace is active, the associated data trace is copied.
- As a trace with a name (string variable).

The created memory trace can be specified as follows:

- As the memory trace named Mem<n> [Trc<m>], where n = 1, ... 8 and Trc<m> is the name of the copied data trace (MDATA1, MDATA2, MDATA3, MDATA4, MDATA5, MDATA6, MDATA7, MDATA8).

- As a memory trace with an arbitrary name (string variable).

An existing memory trace with the same name is overwritten.

**Note:** The copied trace is the data trace which is not modified by any mathematical operations. To copy a mathematical trace to a memory trace, use `TRACe:COPIe:MATH`. To copy the active trace to the memory using an automatic memory trace name, use `CALCulate<Chn>:MATH:MEMorize`.

**Setting parameters:**

<MemTraceName> Name of the memory trace (see also [Table 6-10](#)).

Range: <memory\_trace> is either a string variable (enclosed in single or double quotes) or one of the following reserved names (no string variables): MDATA1 | MDATA2 | MDATA3 | MDATA4 | MDATA5 | MDATA6 | MDATA7 | MDATA8 (only for memory traces Mem<n>[Trc<m>], where n = 1, ... 8).

<DataTraceName> Name of the data trace (see also [Table 6-10](#)).

Range: <data\_trace> is either a string variable (enclosed in single or double quotes) or one of the following reserved names (no string variables): CH1DATA | CH2DATA | CH3DATA | CH4DATA (only for the active data trace in channels Ch1, Ch2, Ch3, Ch4).

**Example:**

```
*RST; :SWE:POIN 20
```

Create a trace with 20 sweep points, making the created trace the active trace of channel 1 (omitted optional mnemonic SENSE1).

```
TRAC:COPIe "Mem_Pt20", CH1DATA
```

Copy the current state of the created trace to a memory trace named "Mem\_Pt20". The memory trace is not displayed.

```
DISP:WIND:TRAC2:FEED "MEM_PT20"
```

Display the created memory trace in the active diagram area (diagram area no. 1).

**Usage:** Setting only

**Manual operation:** See "[Data to <Destination>](#)" on page 168

---

**TRACe:COPIe:MATH** <MemTraceName>, <DataTraceName>

Copies a mathematical trace to a memory trace. The trace to be copied can be specified by two alternative methods:

- As the active mathematical trace of channels 1 to 4 (CH1DATA, CH2DATA, CH3DATA, CH4DATA)
- As a trace with a name (string variable).



The created memory trace can be specified as follows:

- As the memory trace named `Mem<n>[Trc<m>]`, where `n = 1, ... 8` and `Trc<m>` is the name of the copied data trace (`MDATA1`, `MDATA2`, `MDATA3`, `MDATA4`, `MDATA5`, `MDATA6`, `MDATA7`, `MDATA8`).
- As a memory trace with an arbitrary name (string variable).

An existing memory trace with the same name is overwritten.

**Note:** To copy a data trace which is not modified by any mathematical operations, use `TRACe:COPI`

**Setting parameters:**

- `<MemTraceName>` Name of the memory trace (see also [Table 6-10](#)).
- Range: `<memory_trace>` is either a string variable (enclosed in single or double quotes) or one of the following reserved names (no string variables): `MDATA1` | `MDATA2` | `MDATA3` | `MDATA4` | `MDATA5` | `MDATA6` | `MDATA7` | `MDATA8` (only for memory traces `Mem<n>[Trc<m>]`, where `n = 1, ... 8`).
- `<DataTraceName>` Name of the data trace (see also [Table 6-10](#)).
- Range: `<data_trace>` is either a string variable (enclosed in single or double quotes) or one of the following reserved names (no string variables): `CH1DATA` | `CH2DATA` | `CH3DATA` | `CH4DATA` (only for the active data trace in channels `Ch1`, `Ch2`, `Ch3`, `Ch4`).

**Example:**

```
*RST; :SWE:POIN 20
Create a trace with 20 sweep points, making the created trace
the active trace of channel 1 (omitted optional mnemonic
SENSe1).
CALC:MATH:SDEF 'Trc1 / 2'; :CALC:MATH:STAT ON
Define a mathematical trace, dividing the data trace by 2. Acti-
vate the mathematical mode and display the mathematical trace
instead of the data trace.
TRAC:COPI:MATH 'Mem_Pt20',CH1DATA; :CALC:MATH:
STAT OFF
Copy the current state of the mathematical trace to a memory
trace named "Mem_Pt20". The memory trace is not displayed.
Switch the display back to the data trace.
DISP:WIND:TRAC2:FEED 'MEM_PT20'
Display the created memory trace together with the data trace.
```

**Usage:** Setting only

## 6.3.20 TRIGger Commands

### 6.3.20.1 TRIGger[:SEquence]...

The `TRIGger[:SEquence]...` commands synchronize the analyzer's actions (in particular, the start of a measurement sequence) with external events. These events are indicated to the VNA by sending trigger signals via EXT TRIG IN or the Handler I/O (R&S ZN-B14).

|                                                                           |     |
|---------------------------------------------------------------------------|-----|
| <code>TRIGger&lt;Ch&gt;[:SEquence]:HOLDoff</code> .....                   | 738 |
| <code>TRIGger&lt;Ch&gt;[:SEquence]:LINK</code> .....                      | 738 |
| <code>TRIGger&lt;Ch&gt;[:SEquence]:MULTiple:HOLDoff</code> .....          | 739 |
| <code>TRIGger&lt;Ch&gt;[:SEquence]:MULTiple:SLOPe&lt;Num&gt;</code> ..... | 739 |
| <code>TRIGger&lt;Ch&gt;[:SEquence]:MULTiple:SOURce</code> .....           | 740 |
| <code>TRIGger&lt;Ch&gt;[:SEquence]:SLOPe</code> .....                     | 741 |
| <code>TRIGger&lt;Ch&gt;[:SEquence]:SOURce</code> .....                    | 741 |

---

#### `TRIGger<Ch>[:SEquence]:HOLDoff <DelayTime>`

Sets a delay time between the trigger event and the start of the measurement ("Trigger Delay").

**Suffix:**

<Ch> Channel number.

**Parameters:**

<DelayTime> Delay time.  
 Range: 0 s to 13680 s  
 Increment: 10 ms  
 \*RST: 0 s  
 Default unit: s

**Example:**

```
TRIG:SOUR MAN
Activate external trigger source.
TRIG:HOLD UP
Set a delay time of 10 ms.
```

**Manual operation:** See "[Delay](#)" on page 307

---

#### `TRIGger<Ch>[:SEquence]:LINK <MeasSequence>`

Selects the triggered measurement sequence. The identifier for the sequence is a string variable.

**Suffix:**

<Ch> Channel number

**Parameters:**

<MeasSequence> Triggered measurement sequence, string variable.  
 'SWEep' – trigger event starts an entire sweep.  
 'SEGment' – trigger event starts a sweep segment, if segmented frequency sweep is active (see example below). If another sweep type is active, the trigger event starts an entire sweep.  
 'POINT' – trigger event starts measurement at the next sweep point.  
 'PPOINT' – trigger event starts the next partial measurement at the current or at the next sweep point.  
 \*RST: 'SWEep'

**Example:**

```
SEGM:ADD; :SWE:TYPE SEGM
Select segmented frequency sweep.
TRIG:LINK 'SEGM'
Select a trigger segment as triggered measurement sequence.
TRIG:LINK?
Query the triggered measurement sequence. The response is
'SEGMENT'.
```

**Manual operation:** See ["Sequence"](#) on page 306

**TRIGger<Ch>[:SEquence]:MULTiple:HOLDoff** <MeasSequence>[, <DelayTime>]

Sets a delay time between the trigger event and the start of the measurement ("Trigger Delay") in multiple trigger mode.

**Suffix:**

<Ch> Channel number

**Parameters:**

<MeasSequence> SWEep | SEGment | POINT | PPOINT  
 Triggered measurement sequence, PPOINT denotes "partial measurement"; see [TRIGger<Ch>\[:SEquence\]:LINK](#).

<DelayTime> Delay time  
 Range: 0 s to 13680 s  
 Increment: 10 ms  
 \*RST: 0 s  
 Default unit: s

**Example:** See [TRIGger<Ch>\[:SEquence\]:MULTiple:SOURce](#)

**Manual operation:** See ["Source / Slope / Level / Delay"](#) on page 308

**TRIGger<Ch>[:SEquence]:MULTiple:SLOPe<Num>** <MeasSequence>[, <Slope>]

Qualifies whether the multiple trigger events occur on the rising or on the falling edge or on the beginning of the high / low level periods of the external TTL trigger signal <Num>.

|                          |                                                                                                                                                                             |
|--------------------------|-----------------------------------------------------------------------------------------------------------------------------------------------------------------------------|
| <b>Suffix:</b>           |                                                                                                                                                                             |
| <Ch>                     | Channel number                                                                                                                                                              |
| <Num>                    | Number of trigger signal (1 or 2)                                                                                                                                           |
| <b>Parameters:</b>       |                                                                                                                                                                             |
| <MeasSequence>           | SWEep   SEGMENT   POINT   PPOINT<br>Triggered measurement sequence, PPOINT denotes "partial measurement"; see <a href="#">TRIGGER&lt;Ch&gt;[:SEQUENCE]:LINK</a> .           |
| <Slope>                  | POSitive   NEGative   HIGH   LOW<br>Trigger slope for the triggered measurement sequence:<br>POSitive   NEGative - rising or falling edge<br>HIGH   LOW - high or low level |
| <b>Example:</b>          | See <a href="#">TRIGGER&lt;Ch&gt;[:SEQUENCE]:MULTIPLE:SOURCE</a>                                                                                                            |
| <b>Manual operation:</b> | See " <a href="#">Source / Slope / Level / Delay</a> " on page 308                                                                                                          |

---

**TRIGGER<Ch>[:SEQUENCE]:MULTIPLE:SOURCE <Sequence>[, <TrigSource>]**

Selects the source of the trigger events that the analyzer uses to start a measurement sequence in multiple trigger mode.

|                          |                                                                                                                                                                                                                                                                                                                                                                                     |
|--------------------------|-------------------------------------------------------------------------------------------------------------------------------------------------------------------------------------------------------------------------------------------------------------------------------------------------------------------------------------------------------------------------------------|
| <b>Suffix:</b>           |                                                                                                                                                                                                                                                                                                                                                                                     |
| <Ch>                     | Channel number                                                                                                                                                                                                                                                                                                                                                                      |
| <b>Parameters:</b>       |                                                                                                                                                                                                                                                                                                                                                                                     |
| <Sequence>               | SWEep   SEGMENT   POINT   PPOINT<br>Triggered measurement sequence, PPOINT denotes "partial measurement"; see <a href="#">TRIGGER&lt;Ch&gt;[:SEQUENCE]:LINK</a> .                                                                                                                                                                                                                   |
| <TrigSource>             | IMMEDIATE   EXT1   EXT2   E1A2   E1O2   MANUAL<br>Trigger source for the triggered measurement sequence:<br>IMMEDIATE - free run measurement (untriggered).<br>EXT1, EXT2 - external trigger 1, 2.<br>E1A2, E1O2 - external trigger 1 and 2, 1 or 2.<br>MANUAL - trigger event generated by pressing the "Manual Trigger" softkey.                                                  |
| <b>Example:</b>          | TRIG:MULT:SOUR SWE, EXT1; SOUR POIN, EXT2<br>Select external trigger 1 as a trigger source for the entire sweep, external trigger 2 as a trigger source for each point.<br>TRIG:MULT:SLOP1 SWE, POS; SLOP2 POIN, POS<br>Trigger on the rising edges of the external trigger signals 1 and 2.<br>TRIG:MULT:HOLD POIN, 1ms<br>Define a trigger delay of 1 ms before each sweep point. |
| <b>Manual operation:</b> | See " <a href="#">Source / Slope / Level / Delay</a> " on page 308                                                                                                                                                                                                                                                                                                                  |

**TRIGger<Ch>[:SEquence]:SLOPe <Slope>**

Qualifies whether the trigger event occurs on the rising or on the falling edge or on the beginning of the high / low level periods of the external TTL trigger signal.

**Suffix:**

<Ch> Channel number

**Parameters:**

<Slope> POSitive | NEGative | HIGH | LOW  
 Trigger slope for the triggered measurement sequence:  
 POSitive | NEGative - rising or falling edge  
 HIGH | LOW - high or low level

**Example:**

TRIG:SOUR EXT  
 Activate external signal as trigger source.  
 TRIG:SLOP NEG  
 Trigger on the negative edge of the (external TTL) trigger signal.

**Manual operation:** See "[Slope / Level](#)" on page 307

**TRIGger<Ch>[:SEquence]:SOURce <TrigSource>**

Selects the source of the trigger events that the analyzer uses to start a measurement sequence.

**Suffix:**

<Ch> Channel number

**Parameters:**

<TrigSource> IMMEDIATE | EXTERNAL | MANUAL | MULTIPLE  
 IMMEDIATE - free run measurement (untriggered).  
 EXTERNAL - trigger by external signal applied to the EXT TRIGGER connector or pin 2 of the USER PORT on the rear panel.  
 MANUAL - trigger event generated by pressing the "Manual Trigger" softkey.  
 MULTIPLE - multiple trigger mode, configured by the TRIGger<Ch>[:SEquence]:MULTIPLE... commands.

**Example:**

TRIG:SOUR MAN  
 Activate manual trigger mode. The analyzer starts the next measurement sequence when the "Manual Trigger" button is pressed.

**Manual operation:** See "[Free Run / External / Manual / Multiple Triggers](#)" on page 305

**6.3.20.2 TRIGger:CHANnel:AUXiliary...**

The TRIGger:CHANnel<Ch>:AUXiliary... commands control the external trigger output EXT TRIG OUT at the rear panel of the instrument. The output trigger signal

consists of TTL pulses of configurable duration and polarity which may be sent before or after each sweep or measurement point.

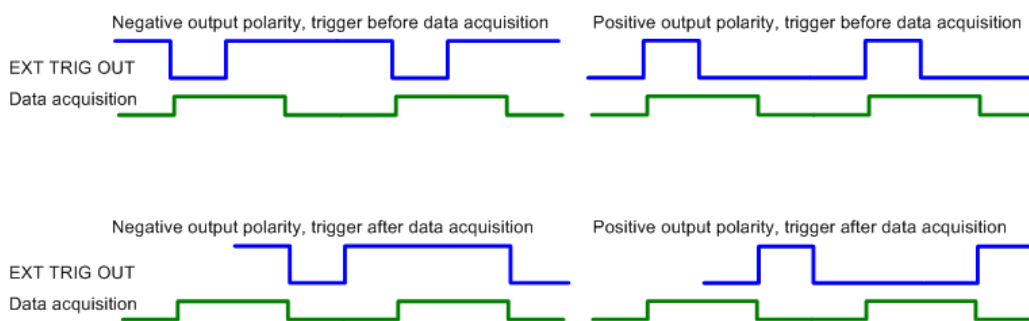

**Figure 6-1: Output trigger signal at EXT TRIG OUT**

|                                                                              |     |
|------------------------------------------------------------------------------|-----|
| <a href="#">TRIGger:CHANnel&lt;Ch&gt;:AUXiliary&lt;n&gt;:DURation</a> .....  | 742 |
| <a href="#">TRIGger:CHANnel&lt;Ch&gt;:AUXiliary&lt;n&gt;[:ENABLE]</a> .....  | 742 |
| <a href="#">TRIGger:CHANnel&lt;Ch&gt;:AUXiliary&lt;n&gt;:INTerval</a> .....  | 743 |
| <a href="#">TRIGger:CHANnel&lt;Ch&gt;:AUXiliary&lt;n&gt;:OPOLarity</a> ..... | 743 |
| <a href="#">TRIGger:CHANnel&lt;Ch&gt;:AUXiliary&lt;n&gt;:POSition</a> .....  | 744 |

---

#### **TRIGger:CHANnel<Ch>:AUXiliary<n>:DURation <TrigOutDuration>**

Specifies the width of the output trigger pulses at EXT TRIG OUT. The trigger duration must be shorter than the time lag between two consecutive triggered measurements. This time lag is equal to the "Sweep Time" (if the output trigger signal is sent once every sweep, `TRIGger:CHANnel<Ch>:AUXiliary<n>:INTerval SWEep`) or to the sweep time divided by the number of points (for `TRIGger:CHANnel<Ch>:AUXiliary<n>:INTerval POINT`).

If the trigger duration is too long, you can modify one of the following settings:

- Reduce the trigger duration, if possible.
- Slow down the sweep: select a smaller bandwidth or increase the "Sweep Time" setting.

#### **Suffix:**

**<Ch>** Channel number

**<n>** Auxiliary channel number. This suffix is ignored; it can be set to 1 or omitted.

#### **Parameters:**

**<TrigOutDuration>** Range: 1 us (1E-6 s) to 1 s  
 \*RST: 1 us  
 Default unit: s

**Example:** See `TRIGger:CHANnel<Ch>:AUXiliary<n>[:ENABLE]`

---

#### **TRIGger:CHANnel<Ch>:AUXiliary<n>[:ENABLE] <EnableTriggOut>**

Turns the external trigger output EXT TRIG OUT for channel no. <Ch> on or off.

**Suffix:**

|      |                                                                                  |
|------|----------------------------------------------------------------------------------|
| <Ch> | Channel number                                                                   |
| <n>  | Auxiliary channel number. This suffix is ignored; it can be set to 1 or omitted. |

**Parameters:**

|                  |                                                      |
|------------------|------------------------------------------------------|
| <EnableTriggOut> | Turn trigger output on (ON) or off (OFF, no signal). |
| *RST:            | OFF                                                  |

**Example:**

```
TRIGger:CHANnel:AUXiliary:ENABLE ON
Turn on the trigger output for channel no. 1 (channel suffix omitted).
TRIGger:CHANnel:AUXiliary:DURation 10 us
Change the width of the output trigger pulses.
TRIGger:CHANnel:AUXiliary:POSition BEFORE
Send the output trigger pulses before data acquisition starts.
TRIGger:CHANnel:AUXiliary:INTerval SWEEp
Send one output trigger pulse per sweep.
TRIGger:CHANnel:AUXiliary:OPOLarity POSitive
Select positive polarity for the output trigger pulses.
```

**TRIGger:CHANnel<Ch>:AUXiliary<n>:INTerval <Type>**

Specifies whether the trigger output pulses are sent once every measurement point or once every sweep.

**Suffix:**

|      |                                                                                  |
|------|----------------------------------------------------------------------------------|
| <Ch> | Channel number                                                                   |
| <n>  | Auxiliary channel number. This suffix is ignored; it can be set to 1 or omitted. |

**Parameters:**

|        |               |
|--------|---------------|
| <Type> | POINT   SWEEp |
| *RST:  | SWEEp         |

**Example:**

See `TRIGger:CHANnel<Ch>:AUXiliary<n>[:ENABLE]`

**TRIGger:CHANnel<Ch>:AUXiliary<n>:OPOLarity <Type>**

Selects the polarity of the output trigger pulses; see [Figure 6-1](#).

**Suffix:**

|      |                                                                                  |
|------|----------------------------------------------------------------------------------|
| <Ch> | Channel number                                                                   |
| <n>  | Auxiliary channel number. This suffix is ignored; it can be set to 1 or omitted. |

**Parameters:**

|        |                     |
|--------|---------------------|
| <Type> | POSitive   NEGative |
| *RST:  | NEGative            |

**Example:**

See `TRIGger:CHANnel<Ch>:AUXiliary<n>[:ENABLE]`

**TRIGger:CHANnel<Ch>:AUXiliary<n>:POSition <Type>**

Specifies whether the trigger output signal is sent before or after data acquisition; see [Figure 6-1](#). Choose this setting according to the external device to be triggered:

- **BEFore** is appropriate if the the device needs to be triggered before the data is acquired (typical example: a power meter which is used for power calibration).
- **AFTer** is appropriate if the device needs to be triggered just after data acquisition (typical example: an external generator which must be re-configured in order to get ready for the next measurement).

**Suffix:**

|      |                                                                                  |
|------|----------------------------------------------------------------------------------|
| <Ch> | Channel number                                                                   |
| <n>  | Auxiliary channel number. This suffix is ignored; it can be set to 1 or omitted. |

**Parameters:**

|        |                |
|--------|----------------|
| <Type> | BEFore   AFTer |
| *RST:  | AFTer          |

**Example:** See `TRIGger:CHANnel<Ch>:AUXiliary<n>[:ENABLE]`

## 6.4 R&S ZVR/ZVAB Compatible Commands

The commands in this chapter are supported for compatibility with analyzers of the R&S ZVR and R&S ZVAB family; they do not introduce any new functionality. For new programs, it is recommended to use the commands in [chapter Chapter 6.3, "SCPI Command Reference"](#), on page 401.

|                                                                               |     |
|-------------------------------------------------------------------------------|-----|
| <code>CALCulate&lt;Chn&gt;:LIMit:CONTRol:DOMain</code> .....                  | 745 |
| <code>CALCulate&lt;Chn&gt;:LIMit:RDOMain:COMPLex</code> .....                 | 746 |
| <code>CALCulate&lt;Chn&gt;:LIMit:RDOMain:FORMat</code> .....                  | 746 |
| <code>CALCulate&lt;Chn&gt;:LIMit:RDOMain:SPACing</code> .....                 | 747 |
| <code>CALCulate&lt;Chn&gt;:LIMit:LOWer:STATe</code> .....                     | 747 |
| <code>CALCulate&lt;Chn&gt;:LIMit:UPPer:STATe</code> .....                     | 747 |
| <code>CALCulate&lt;Ch&gt;:PARAmeter:DEFine</code> .....                       | 748 |
| <code>CALCulate&lt;Chn&gt;:MARKer&lt;Mk&gt;:FUNCTion:BWIDth</code> .....      | 749 |
| <code>CALCulate&lt;Chn&gt;:MARKer&lt;Mk&gt;:FUNCTion:DELTA:STATe</code> ..... | 749 |
| <code>CALCulate&lt;Chn&gt;:MARKer&lt;Mk&gt;:FUNCTion:TARGeT</code> .....      | 750 |
| <code>CALCulate&lt;Chn&gt;:MARKer&lt;Mk&gt;:FUNCTion[:SELect]</code> .....    | 750 |
| <code>CALCulate&lt;Chn&gt;:MARKer&lt;Mk&gt;:MAXimum</code> .....              | 751 |
| <code>CALCulate&lt;Chn&gt;:MARKer&lt;Mk&gt;:MINimum</code> .....              | 751 |
| <code>CALCulate&lt;Chn&gt;:MARKer&lt;Mk&gt;:SEARch:LEFT</code> .....          | 751 |
| <code>CALCulate&lt;Chn&gt;:MARKer&lt;Mk&gt;:SEARch:NEXT</code> .....          | 751 |
| <code>CALCulate&lt;Chn&gt;:MARKer&lt;Mk&gt;:SEARch:RIGHT</code> .....         | 751 |
| <code>CALCulate&lt;Chn&gt;:MARKer&lt;Mk&gt;:SEARch[:IMMEDIATE]</code> .....   | 751 |
| <code>CALCulate&lt;Chn&gt;:MATH[:EXPRession][:DEFine]</code> .....            | 752 |
| <code>DIAGnostic:SERVice:FUNCTion</code> .....                                | 752 |
| <code>FORMat:DEXPort:SOURce</code> .....                                      | 752 |
| <code>INSTrument[:SELect]</code> .....                                        | 753 |



|                                                            |     |
|------------------------------------------------------------|-----|
| OUTPut<Chn>:DPORt.....                                     | 753 |
| [SENSe<Ch>:]CORRection:CKIT:<ConnType>:<StandardType>..... | 754 |
| [SENSe:]CORRection:CKIT:INSTall.....                       | 755 |
| [SENSe<Ch>:]CORRection:COLLect[:ACQuire].....              | 756 |
| [SENSe<Ch>:]CORRection:COLLect:METhod.....                 | 757 |
| [SENSe<Ch>:]CORRection:COLLect:SAVE:DEFault.....           | 757 |
| [SENSe<Ch>:]CORRection:COLLect:SAVE[:DUMMy].....           | 758 |
| [SENSe<Ch>:]CORRection:DATA.....                           | 759 |
| [SENSe<Ch>:]CORRection:OFFSet<PhyPt>:MAGNitude.....        | 761 |
| [SENSe<Ch>:]FREQuency:MODE.....                            | 761 |
| [SENSe<Ch>:]SEGment<Seg>:CLEar.....                        | 762 |
| [SENSe<Ch>:]SEGment<Seg>:OVERlap.....                      | 762 |
| [SENSe<Ch>:]SWEep:SPACing.....                             | 762 |
| [SENSe<Chn>:]FUNction[:ON].....                            | 763 |
| SOURce<Ch>:POWer<PhyPt>:CORRection:COLLect[:ACQuire].....  | 764 |
| TRACe:CLEar.....                                           | 765 |
| TRACe[:DATA][:RESPonse][:ALL]?                             | 765 |
| TRACe[:DATA]:STIMulus[:ALL]?                               | 766 |

---

### CALCulate<Chn>:LIMit:CONtrol:DOMain <SweepType>

Deletes the existing limit line and (re-)defines the physical units of the stimulus values of the limit line. The units of the response values and the scaling of the y-axis can be defined via `CALCulate<Ch>:LIMit:RDOMain:...`

#### Suffix:

<Chn> Channel number used to identify the active trace.

#### Setting parameters:

<SweepType> FLIN | FLOG | FSEG | FSINgle | TLIN | TLOG | PLIN | PLOG | PSINgle

Keywords for the units of the stimulus values. The selected unit must be compatible with the sweep type (`[SENSe<Ch>:]SWEep:TYPE`); otherwise the limit line can not be displayed and no limit check is possible.

The parameters form three groups: FLIN, FLOG, FSEG, and FSINgle select frequency units for the limit line. TLIN and TLOG select time units, PLIN, PLOG and PSINgle select power units.

\*RST: FLIN  
 Default unit: Hz (for FLIN, FLOG, FSEG, FSINgle); s (for TLIN, TLOG), dBm (for PLIN, PLOG, PSINgle).

#### Example:

```
SWE:TYPE POW
Select a power sweep.
CALC:LIM:CONT:DOM PLIN
Delete all existing limit line segments and select level units for
the limit line of the active trace.
CALC:LIM:CONT -20 DBM, -10 DBM
Define a limit line segment in the stimulus range between -20
dBm and -10 dBm.
```

**Usage:** Setting only

---

**CALCulate<Chn>:LIMit:RDOMain:COMPLex <UnitRef>**

Deletes the existing limit line and (re-)defines the physical units of the response values of the limit line. The units of the stimulus values are defined via `CALCulate<Chn>:LIMit:CONTrol:DOMain`.

**Tip:** This command is complemented by `CALCulate<Chn>:LIMit:RDOMain:FORMat` and `CALCulate<Chn>:LIMit:RDOMain:SPACing`.

**Suffix:**

<Chn> Channel number used to identify the active trace.

**Setting parameters:**

<UnitRef> S | SINV | Y | Z | YREL | ZREL

Keyword for the physical unit of the response values. The parameters form four groups: S and SINV select relative units (dB) for the limit line. Y selects admittance units (S/Siemens). Z selects impedance units ( $\Omega$ ). YREL and ZREL select dimensionless numbers (U).

**Usage:** Setting only

---

**CALCulate<Chn>:LIMit:RDOMain:FORMat <UnitRef>**

Deletes the existing limit line and (re-)defines the physical units of the response values of the limit line. The units of the stimulus values are defined via `CALCulate<Chn>:LIMit:CONTrol:DOMain`.

**Tip:** This command is complemented by `CALCulate<Chn>:LIMit:RDOMain:COMPLex` and `CALCulate<Chn>:LIMit:RDOMain:SPACing`.

**Suffix:**

<Chn> Channel number used to identify the active trace.

**Setting parameters:**

<UnitRef> COMPLex | MAGNitude | PHASe | REAL | IMAGinary | SWR | GDELay | L | C

Keyword for the physical unit of the response values. The parameters form four groups: COMPLex, REAL, IMAGinary, and SWR select dimensionless numbers (U) for the limit line. MAGNitude selects relative units (dB). PHASe selects phase units (deg). GDELay selects time units (s). L selects inductance units (H/Henry). C selects capacitance units (F/Farad).

**Usage:** Setting only

**CALCulate<Chn>:LIMit:RDOMain:SPACing <Format>**

Deletes the existing limit line and (re-)defines the physical units of the response values of the limit line. The units of the stimulus values are defined via `CALCulate<Chn>:LIMit:CONTrol:DOMain`.

**Tip:** This command is complemented by `CALCulate<Chn>:LIMit:RDOMain:COMPLex` and `CALCulate<Chn>:LIMit:RDOMain:FORMat`.

**Suffix:**

<Chn> Channel number used to identify the active trace.

**Setting parameters:**

<Format> LINear | LOGarithmic | DB | SIC  
Keyword for the physical unit of the response values.  
Default unit: dB (irrespective of the parameter selected)

**Usage:** Setting only

**CALCulate<Chn>:LIMit:LOWer:STATe <Boolean>****CALCulate<Chn>:LIMit:UPPer:STATe <Boolean>**

These commands switch the lower and upper limit check on or off. Lower limit line segments are assigned even numbers; upper limit line segments are assigned odd numbers; see `CALCulate<Chn>:LIMit:LOWer[:DATA]` and `CALCulate<Chn>:LIMit:UPPer[:DATA]`. `CALCulate<Chn>:LIMit:LOWer:STATe` does not affect segments with odd numbers; `CALCulate<Chn>:LIMit:UPPer:STATe` does not affect segments with even numbers.

**Note:** Use `CALCulate<Chn>:LIMit:STATe` to switch on or off the entire limit check, including upper and lower limit lines.

**Suffix:**

<Chn> Channel number used to identify the active trace.

**Parameters:**

<Boolean> ON | OFF - switch limit check on or off.  
\*RST: OFF

**Example:**

```
CALC:LIM:LOW -10, 0, 0, -10
```

Define two limit line segments covering the entire sweep range. Two upper limit line segments with default response values are created in addition.

```
CALC:LIM:UPP 0, 5, 5, 0
```

Change the response values of the upper limit line segments.

```
CALC:LIM:LOW:STAT ON; :CALC:LIM:UPP:STAT ON; :
```

```
CALC:LIM:FAIL?
```

Switch the limit check on and query the result.

**Manual operation:** See "Limit Check" on page 196

**CALCulate<Ch>:PARAmeter:DEFine** <TraceName>, <Result>[, <TestPortNum>]

Creates a trace and assigns a channel number, a name and a measurement parameter to it. The trace is not displayed. To display a trace defined via

CALCulate<Ch>:PARAmeter:DEFine, a window must be created (`DISPlay[:WINDow<Wnd>] [:STATe]ON`) and the trace must be assigned to this window (`DISPlay[:WINDow<Wnd>]:TRACe<WndTr>:FEED`); see example below.

Traces must be selected to become active traces; see `CALCulate<Ch>:PARAmeter:SElect`.

**Note:** The parameter names in this command differ from R&S ZNC/ZND conventions; moreover the parameter list is not complete. The alternative command `CALCulate<Ch>:PARAmeter:SDEFine` uses a complete parameter list with compatible names.

**Suffix:**

<Ch> Channel number. <Ch> may be used to reference a previously defined channel. If <Ch> does not exist, it is generated with default channel settings.

**Setting parameters:**

<TraceName> Trace name, e.g. 'Trc4'. See "Rules for trace names" in "Trace Manager Table" on page 165.

<Result> S11 | S12 | S13 | S14 | S21 | S22 | S23 | S24 | S31 | S32 | S33 | S34 | S41 | S42 | S43 | S44 | A | B | C | D | R1 | R2 | R3 | R4 | AB | AC | AD | BA | BC | BD | CA | CB | CD | DA | DB | DC | AR1 | AR2 | AR3 | AR4 | BR1 | BR2 | BR3 | BR4 | CR1 | CR2 | CR3 | CR4 | DR1 | DR2 | DR3 | DR4 | R1A | R1B | R1C | R1D | R2A | R2B | R2C | R2D | R3A | R3B | R3C | R3D | R4A | R4B | R4C | R4D | R1R2 | R1R3 | R1R4 | R2R1 | R2R3 | R2R4 | R3R1 | R3R2 | R3R4 | R4R1 | R4R2 | R4R3

Measurement parameter; see list of parameters below.

<TestPortNum> Test port number, drive port for wave quantities and ratios, ignored for S-parameters.

**Example:**

```
CALC4:PAR:DEF 'Ch4Tr1', S11
```

Create channel 4 and a trace named Ch4Tr1 to measure the input reflection coefficient S11.

```
DISP:WIND:STAT ON
```

Create diagram area no. 1.

```
DISP:WIND:TRAC2:FEED 'CH4TR1'
```

Display the generated trace in diagram area no. 1, assigning a trace number 2.

**Usage:** Setting only

The measurement parameter is selected by means of the following keywords (the selection depends on the number of test ports of the analyzer, e.g. S44 is not available on 2-port analyzers):

|                                                                                                                                                                                               |                                                                                                                                                                        |
|-----------------------------------------------------------------------------------------------------------------------------------------------------------------------------------------------|------------------------------------------------------------------------------------------------------------------------------------------------------------------------|
| S11   S12   S13   S14   S21   S22   S23   S24   S31   S32   S33   S34   S41   S42   S43   S44                                                                                                 | S-parameters                                                                                                                                                           |
| A   B   C   D                                                                                                                                                                                 | Wave quantities $b_1, b_2, b_3, b_4$ (received waves)                                                                                                                  |
| R1   R2   R3   R4                                                                                                                                                                             | Wave quantities $a_1, a_2, a_3, a_4$ (reference waves)                                                                                                                 |
| AB   AC   AD   BA   BC   BD   CA   CB   CD   DA   dB   DC                                                                                                                                     | Ratio of wave quantities $b_1/b_2, b_1/b_3, \dots, b_4/b_3$ (received waves only)                                                                                      |
| AR1   AR2   AR3   AR4   BR1   BR2   BR3   BR4   CR1   CR2   CR3   CR4   DR1   DR2   DR3   DR4   R1A   R1B   R1C   R1D   R2A   R2B   R2C   R2D   R3A   R3B   R3C   R3D   R4A   R4B   R4C   R4D | Ratio of wave quantities $b_1/a_1, b_1/a_2, \dots, b_4/a_4, a_1/b_1, a_1/b_2, \dots, A_4/B_4$ (received waves to reference waves or reference waves to received waves) |
| R1R2   R1R3   R1R4   R2R1   R2R3   R2R4   R3R1   R3R2   R3R4   R4R1   R4R2   R4R3                                                                                                             | Ratio of wave quantities $a_1/a_2, a_1/a_3, \dots, a_4/a_3$ (reference waves only)                                                                                     |

---

**CALCulate<Chn>:MARKer<Mk>:FUNCtion:BWIDth <Bandwidth>**

Defines the bandfilter level, i.e. the minimum excursion for the bandpass and bandstop peaks.

**Tip:** Use `CALCulate<Chn>:MARKer<Mk>:BWIDth` to set the bandwidth and query the results of a bandfilter search. Note the sign convention for input values.

**Suffix:**

<Chn> Channel number used to identify the active trace.

<Mk> Marker number in the range 1 to 10. This numeric suffix is ignored and may be set to any value because the bandfilter search functions always use markers M1 to M4.

**Parameters:**

<Bandwidth> Range: -100 dB to 100 dB  
 Increment: 0.03 dB  
 \*RST: 3 dB  
 Default unit: dB

**Example:** See `CALCulate<Chn>:MARKer<Mk>:BWIDth`

---

**CALCulate<Chn>:MARKer<Mk>:FUNCtion:DELTA:STATe <Boolean>**

Switches the delta mode for marker <Mk> on trace no. <Chn> on or off.

**Note:** This command is the ZVR-compatible equivalent of `CALCulate<Chn>:MARKer<Mk>:DELTA[:STATe]`.

**Suffix:**

<Chn> Channel number used to identify the active trace.

<Mk> Marker number in the range 1 to 10.

**Parameters:**

<Boolean> ON | OFF - enable or disable the delta mode.  
 \*RST: OFF

**CALCulate<Chn>:MARKer<Mk>:FUNction:TARGet <SearchValue>**

Defines the target value for the target search of marker no. <Mk>, which can be activated using `CALCulate<Chn>:MARKer<Mk>:FUNction:EXECuteTARGet`.

**Note:** This command is the ZVR-compatible equivalent of `CALCulate<Chn>:MARKer<Mk>:TARGet`.

**Suffix:**

<Chn> Channel number used to identify the active trace.  
 <Mk> Marker number in the range 1 to 10.

**Parameters:**

<SearchValue> Target search value of marker no. <Mk>.  
 Range: Depending on the format of the active trace. For a dB Mag trace the range is -200 dB to +200 dB.  
 Increment: 0.1 dB  
 \*RST: Depending on the trace format; 0 dB for a dB Mag trace.  
 Default unit: dB

**CALCulate<Chn>:MARKer<Mk>:FUNction[:SElect] <Mode>**

Selects a search mode for marker no. <Mk>, which can then be initiated using one of the `CALCulate<Ch>:MARKer<Mk>:SEARCh...`, `CALCulate<Ch>:MARKer<Mk>:MAXimum` or `CALCulate<Ch>:MARKer<Mk>:MINimum` functions. The marker must be created before using `CALCulate<Chn>:MARKer<Mk>[:STATe]ON`.

**Note:** This command is not needed except for compatibility with ZVR programs. Use `CALCulate<Chn>:MARKer<Mk>:FUNction:EXECute` to select a search mode and at the same time initiate the search. The

`CALCulate<Ch>:MARKer<Mk>:SEARCh...`, `CALCulate<Ch>:MARKer<Mk>:MAXimum` or `CALCulate<Ch>:MARKer<Mk>:MINimum` functions also select the search mode.

**Suffix:**

<Chn> Channel number used to identify the active trace.  
 <Mk> Marker number in the range 1 to 10. For a bandfilter search (BFILter) this numeric suffix is ignored and may be set to any value because the bandfilter search functions always use markers M1 to M4.

**Parameters:**

<Mode> MAXimum | MINimum | RPEak | LPEak | NPEak | TARGet | LTARget | RTARget | BFILter | MMAXimum | MMINimum  
 See `CALCulate<Chn>:MARKer<Mk>:FUNction:EXECute`

**CALCulate<Chn>:MARKer<Mk>:MAXimum****CALCulate<Chn>:MARKer<Mk>:MINimum**

These commands select a search mode for marker no. <Mk> and initiate a maximum and minimum search, respectively. The marker must be created before using `CALCulate<Chn>:MARKer<Mk>[:STATe]ON`.

**Note:** These commands are the ZVR-compatible equivalent of `CALCulate<Chn>:MARKer<Mk>:FUNCTION:EXECuteMINimum` | `MAXimum`.

**Suffix:**

<Chn> Channel number used to identify the active trace.

<Mk> Marker number in the range 1 to 10.

**Usage:** Event

**CALCulate<Chn>:MARKer<Mk>:SEARch:LEFT****CALCulate<Chn>:MARKer<Mk>:SEARch:NEXT****CALCulate<Chn>:MARKer<Mk>:SEARch:RIGHT**

These commands select a search mode for marker no. <Mk> and initiate a search for the next valid peak to the left, the next highest or lowest value among the valid peaks, and the next valid peak to the right. The marker must be created before using `CALCulate<Chn>:MARKer<Mk>[:STATe]ON`.

**Note:** These commands are the ZVR-compatible equivalents of `CALCulate<Chn>:MARKer<Mk>:FUNCTION:EXECuteLPEak` | `NPEak` | `RPEak`.

**Suffix:**

<Chn> Channel number used to identify the active trace.

<Mk> Marker number in the range 1 to 10.

**Usage:** Event

**CALCulate<Chn>:MARKer<Mk>:SEARch[:IMMEDIATE]**

Initiates a search according to the search function selected with `CALCulate<Chn>:MARKer<Mk>:FUNCTION[:SElect]`. The marker must be created before using `CALCulate<Chn>:MARKer<Mk>[:STATe]ON`.

**Note:** Together with `CALCulate<Chn>:MARKer<Mk>:FUNCTION[:SElect]` this command is the ZVR-compatible equivalent of `CALCulate<Chn>:MARKer<Mk>:FUNCTION:EXECute`.

**Suffix:**

<Chn> Channel number used to identify the active trace.

<Mk> Marker number in the range 1 to 10. For a bandfilter search (`BFILter`) this numeric suffix is ignored and may be set to any value because the bandfilter search functions always use markers M1 to M4.

**Usage:** Event

---

**CALCulate**<Chn>:MATH[:EXPRession][:DEFine] <Expression>

Defines a simple mathematical relation between traces. To calculate and display the new mathematical trace, the mathematical mode must be switched on (**CALCulate**<Chn>:MARKer<Mk>[:STATe] ON).

**Note:** This command places some restrictions on the mathematical expression and the operands. Use **CALCulate**<Chn>:MATH[:EXPRession]:SDEFine to define general expressions.

**Suffix:**

<Chn> Channel number used to identify the active trace.

**Parameters:**

<Expression> <expr>  
 (<operand1><operator1><operand2>[<operator2><operand3>]) The expression must be enclosed in brackets.  
 Operands: See list of trace names in [Chapter 6.3.19, "TRACe Commands"](#), on page 734.  
 Operators: +, -, \*, /

**Example:**

```
*RST; CALC:MATH:MEM
Copy the current state of the default trace Trc1 to a memory
trace named "Mem2[Trc1]". The memory trace is not displayed.
CALC:MATH (CH1DATA / MDATA2)
Define a mathematical trace, dividing the data trace by the
stored memory trace. The mathematical trace is not displayed
CALC:MATH:STAT ON
Display the mathematical trace instead of the active data trace.
```

---

**DIAGnostic:SERVice:FUNCTion** <SFId1>, <SFId2>...

Activates a service function (mainly for internal use). Service functions are identified by groups of numbers, separated by dots.

**Parameters:**

<SFId1>

<SFId2> Service function identifier entered as a (pseudo-)numeric value, the dots being replaced by commas. Five groups of numbers are allowed at maximum. See also [DIAGnostic:SERVice:SFUNCTion](#).

---

**FORMat:DEXPort:SOURce** <Format>

Defines the format for traces retrieved with the R&S ZVR-compatible command [TRACe\[:DATA\]\[:RESPonse\]\[:ALL\]?](#).



This command is not relevant for results read with the `CALCulate<Chn>:DATA...` commands.

**Parameters:**

`<Format>` FDATa | SDATa | MDATa  
 See list of parameters below. The unit is the default unit of the measured parameter; see `CALCulate<Ch>:PARAMeter:SDEFine`.  
 Range: Depending on the measured parameter and format.  
 \*RST: SDATa

**Example:** See `TRACe[:DATA][:RESPonse][:ALL]?`

The following parameters are related to trace data:

|       |                                                                                                                                                                                                 |
|-------|-------------------------------------------------------------------------------------------------------------------------------------------------------------------------------------------------|
| FDATa | Formatted trace data, according to the selected trace format ( <code>CALCulate&lt;Chn&gt;:FORMat</code> ). 1 value per trace point for Cartesian diagrams, 2 values for polar diagrams.         |
| SDATa | Unformatted trace data: Real and imaginary part of each measurement point. 2 values per trace point irrespective of the selected trace format. The trace mathematics is not taken into account. |
| MDATa | Unformatted trace data (see <code>SDATa</code> ) after evaluation of the trace mathematics.                                                                                                     |

**INSTrument[:SElect] <Channel>**

Selects a channel `<Ch>` as active channel. To select a channel number > 4 use the generalized command `INSTrument:NSElect`.

**Parameters:**

`<Channel>` CHANnel1 | CHANnel2 | CHANnel3 | CHANnel4  
 Number of the channel to be activated. The channel must be created before using `CONFigure:CHANnel<Ch>[:STATe] ON`.  
 Range: CHANNEL1, CHANNEL2, CHANNEL3, CHANNEL4  
 \*RST: CHANNEL1

**Example:** `CONF:CHAN2:STAT ON; :INST CHANNEL2`  
 Create channel no. 2 and select it as the active channel.

**OUTPut<Chn>:DPORT <Port>**

Selects a source port for the stimulus signal (drive port). The setting acts on the active trace. The effect of the drive port selection depends on the measurement parameter associated to the active trace:

- If an S-parameter  $S_{\langle out \rangle \langle in \rangle}$  is measured, the second port number index `<in>` (input port of the DUT = drive port of the analyzer) is set equal to the selected drive port: Drive port selection affects the measured quantity.
- If a wave quantity or a ratio is measured, the drive port is independent from the measured quantity:

**Note:** This command is equivalent to `[SENSe<Chn>:]SWEep:SRCPort`.

**Suffix:**

<Chn> Channel number used to identify the active trace.

**Parameters:**

<Port> PORT<no>  
Physical port number.  
\*RST: PORT1

**Example:**

```
CALC4:PAR:SDEF 'Ch4Tr1', 'A1'
Create channel 4 and a trace named "Ch4Tr1" to measure the
wave quantity a1. The trace automatically becomes the active
trace.
OUTP4:DPOR PORT2
Select drive port 2 for the active trace.
```

**[SENSe<Ch>:]CORRection:CKIT:<ConnType>:<StandardType>** <CalKitName>, <Standard>, <MinFreq>, <MaxFreq>, <DelayParam>, <Loss>, <C0>, <L0>, <C1>, <L1>, <C2>, <L2>, <C3>, <L3>, OPEN | SHORT

Defines the parameters of a calibration standard <StandardType> for a specified connector type <ConnType>. A particular physical standard can be selected by specifying the name of the calibration kit and its serial number. Depending on the standard type, only a subset of the parameters may be used; see [Standard types and their parameters](#).

**Note:** If the specified cal kit does not exist, it is created with the specified calibration standard.

**Suffix:**

<Ch> Channel number. This suffix is ignored because calibration kits are channel-independent.

**Parameters:**

<ConnType> Connector type, one of the following identifiers:  
N50, N75: N 50 Ω or N 75 Ω connectors  
PC7, PC35, PC292: PC 7, PC 3.5 or 2.92 mm connectors  
USER<no>: User-defined connectors UserConn1, UserConn2  
SMA: User-defined connector type SMA ...  
**Note:** This command only supports ZVR-compatible connector types. For general definitions use `[SENSe:]CORRection:CKIT:<StandardType>`.

|                 |                                                                                                                                                                                                                                                                                                                                                                                                                                                                                      |
|-----------------|--------------------------------------------------------------------------------------------------------------------------------------------------------------------------------------------------------------------------------------------------------------------------------------------------------------------------------------------------------------------------------------------------------------------------------------------------------------------------------------|
| <StandardType>  | <p>Standard type. For reflection standards, the first character denotes the gender, e.g.:</p> <p>FOPEN, MOOPEN: Open (f) or Open (m) standard.</p> <p>For transmission standards, the first two characters denotes the genders on both ends, e.g.:</p> <p>FFSNetwork, MFSNetwork, MMSNetwork: Symm. network (ff), symm. network (mf) or symm. network (mm) standard.</p> <p>For a complete list of standard types refer to <a href="#">Standard types and their parameters</a> .</p> |
| Parameter list  | <p>String parameters to specify the configured standard (&lt;CalkitName&gt;, &lt;StandardLabel&gt;) and numeric parameters defining its properties. See <a href="#">Parameter list</a>.</p> <p>*RST:            n/a</p>                                                                                                                                                                                                                                                              |
| <b>Example:</b> | <pre>CORR:CKIT:N50:FOPEN 'ZV-Z21','', 0,1.8E+010,0.0151,0,0,0.22,-0.22,0.0022</pre> <p>Define the properties of the open (f) standard for the N 50 Ω connector type contained in the ZV-Z21 calibration kit: Assign a valid frequency range of 0 Hz to 18 GHz, an electrical length of 15.1 mm, 0 dB loss and define the polynomial coefficients of the fringing capacitance as 0 fF, 0.22 fF/GHz, -0.22 fF/(GHz)<sup>2</sup>, 0.0022 fF/(GHz)<sup>3</sup>.</p>                      |

---

#### [SENSe:]CORRection:CKIT:INSTall <CalKitFile>

Loads cal kit data from a specified R&S ZVR cal kit file.

##### Setting parameters:

<CalKitFile>      String parameter to specify the name and directory of the cal kit file to be loaded.

**Note:** The loaded file must be a R&S ZVR-specific cal kit file with the extension \*.ck. VNA cal kit files (\*.calkit) can be imported using the [MMEMoRY:LOAD:CKIT](#) command. Agilent cal kit files can be imported manually and converted into \*.calkit files.

##### Example:

```
CORR:CKIT:INST 'C:\Users\Public\Documents
\Rohde-Schwarz\Vna\Calibration\Kits\ZCAN.ck'
```

Load the previously created R&S ZVR cal kit file ZCAN.ck from the default cal kit directory.

```
MMEM:STOR:CKIT 'ZCAN', 'C:
\Users\Public\Documents
\Rohde-Schwarz\Vna\Calibration\Kits\ZCAN.calkit'
```

Store the imported cal kit data to a VNA cal kit file ZCAN.calkit (assuming that the cal kit name stored in ZCAN.ck reads "ZCAN").

**Usage:**            Setting only

**[SENSe<Ch>:]CORRection:COLLect[:ACQuire]** <Standard>[, <Dispersion>,  
<Delay>]

Starts a calibration measurement in order to acquire measurement data for the selected standards. The standards are reflection or transmission standards and must be connected to port 1 or 2 of the analyzer.

**Tip:** Use the generalized command `[SENSe<Ch>:]CORRection:COLLect[:ACQuire]:SElected` to obtain measurement data at arbitrary analyzer ports.

**Suffix:**

<Ch> Channel number of the calibrated channel.

**Setting parameters:**

<Standard> THROugh | OPEN1 | OPEN2 | OPEN12 | SHORt1 | SHORt2 | SHORt12 | MATCh1 | MATCh2 | MATCh12 | NET | ATT | IMATCh12 | REFL1 | REFL2 | SLIDe1 | SLIDe2 | SLIDe12 | LINE1 | LINE2 | LINE3 | M1O2 | O1M2 | OSHort1 | OSHort11 | OSHort12 | OSHort13 | OSHort2 | OSHort21 | OSHort22 | OSHort23 | M1S2 | S1M2 | UTHRough

Standard types: Through (between port 1 and 2), Open, Short, Match (MATCh12 and IMATCh12 are synonymous), Symmetric Network (NET), Attenuation (ATT), Reflect, Sliding Match (SLIDe), Line1 (LINE1 and LINE are synonymous), Line2 and Line3 (esp. for TRL calibration), Match/Open (M1O2, O1M2), Match/Short (M1S2, S1M2), Offset Short (OSHort), Unknown Through (UTHRough).

The numbers in the parameter names denote the analyzer ports. Two numbers 12 mean that two separate calibrations are performed at ports 1 and 2. For Offset Short standards, the first number denotes the port (1 or 2), the second number denotes the number of the standard (1 to 3).

\*RST: ON

<Dispersion> Optional status parameter for UTHRough standard:  
OFF - unknown through standard is non-dispersive.  
ON - unknown through standard is dispersive.

\*RST: OFF

<Delay> Optional entry of delay time or phase for UTHRough standard:  
<numeric> - entry of the delay time in ps (for non-dispersive standards) or of an estimate of the phase at the start frequency of the sweep in deg (for dispersive standards). See also background information for `[SENSe<Ch>:]CORRection:COLLect[:ACQuire]:SElected`.

AUTO - the analyzer determines the delay time or phase during the calibration sweep.

\*RST: AUTO

**Example:** See `[SENSe<Ch>:]CORRection:COLLect:SAVE[:DUMMy]`

**Usage:** Setting only

**[SENSe<Ch>:]CORRection:COLLect:METhod <CalType>**

Selects a one-port or two-port calibration type for channel <Ch> at ports 1/2.

**Tip:** Use the generalized command `[SENSe<Ch>:]CORRection:COLLect:METhod:DEFine` to select the calibration type for arbitrary analyzer ports or a multipoint calibration type.

**Suffix:**

<Ch> Channel number of the calibrated channel.

**Parameters:**

<CalType> FRTRans | FTRans | RTRans | TOM | TSM | TRM | TRL | TNA | TOSM | ETOM | ETSM | FOPort1 | FOPort2 | FOPort12 | FOPTport | ROPTport | REFL1 | REFL2 | REFL12 | TPORT | UOSM

Calibration types, TOM, TRM, TRL, TNA, TOSM, Full One Port, One Path Two Port, Normalization (REFL1, REFL2 and REFL12 for one-port, FRTRans, FTRans, RTRans, and TPORT for two-port), TOSM with unknown through.

The numbers in the parameters denote the analyzer ports.

Parameters for two-port calibration types contain no numbers because the command is only valid for ports 1 and 2.

**Example:** See `[SENSe<Ch>:]CORRection:COLLect:SAVE[:DUMMy]`

**[SENSe<Ch>:]CORRection:COLLect:SAVE:DEFault**

Generates a set of default system error correction data for the selected ports and calibration type. The default data set corresponds to a test setup which does not introduce any systematic errors; none of the measurement results acquired previously (`[SENSe<Ch>:]CORRection:COLLect[:ACQuire]`) is taken into account.

**Tip:** The main purpose of the default correction data set is to provide a dummy system error correction which you can replace with your own, external correction data. You may have acquired the external data in a previous session or even on an other instrument. If you want to use the external correction data on the analyzer, simply generate the default data set corresponding to your port configuration and calibration type and overwrite the default data. For details refer to the program example below.

**Note:** This command must be used in combination with the R&S ZVR-compatible commands `[SENSe<Ch>:]CORRection:COLLect:METhod` and `[SENSe<Ch>:]CORRection:DATA`. Use `[SENSe<Ch>:]CORRection:COLLect:SAVE:SElected:DEFault` if you want to use R&S ZNC/ZND-specific calibration commands or if you want to calibrate more than 2 ports.

**Suffix:**

<Ch> Channel number of the calibrated channel

**Example:**

```
CORR:COLL:METH REFL1
```

Select a one-port normalization at port 1 with an open standard as calibration type.

```
CORR:COLL:SAVE:DEF
```

Calculate a dummy system error correction for the normalization at port 1. The dummy system error correction provides the reflection tracking error term SCORR3.

```
INIT:CONT OFF; :INIT; *WAI
```

Stop the sweep to ensure correct transfer of calibration data.

```
CORR:DATA? 'SCORR3'
```

Query the dummy system error correction term. The response is a 1 (written as 1, 0 for the real and imaginary part) for each sweep point (no attenuation and no phase shift between the analyzer and the calibration plane).

```
CORR:DATA 'SCORR3', <ASCII_data>
```

Replace the dummy system error correction term with your own correction data, transferred in ASCII format.

```
INIT:CONT ON
```

Restart the sweep in continuous mode.

**Usage:**

Event

**[SENSe<Ch>:]CORRection:COLLect:SAVE[:DUMMy]**

Calculates the system error correction data from the acquired one or two-port measurement results (`[SENSe<Ch>:]CORRection:COLLect[:ACQuire]`), stores them and applies them to the calibrated channel <Ch>. To avoid incompatibilities, older system error correction data is deleted unless it has been transferred into a cal pool (`MMEMoRY:STORe:CORRection`).

This command is the R&S ZVR-compatible equivalent of `[SENSe<Ch>:]CORRection:COLLect:SAVE:SElected[:DUMMy]`. It must be used in combination with the R&S ZVR-compatible commands for calibration method and standard selection; see example below.

**Suffix:**

<Ch>

Channel number of the calibrated channel.

**Example:**

```
CORR:COLL:METH REFL1
```

Select a one-port normalization at port 1 as calibration type.

```
CORR:COLL:OPEN1
```

Measure an open standard connected to port 1 and store the measurement results of this standard.

```
CORR:COLL:SAVE
```

Calculate the system error correction data and apply it to the active channel.

**Usage:**

Event

**[SENSe<Ch>:]CORRection:DATA** <ErrorTerm>, <Parameter>...

Writes or reads system error correction data for a specific channel <Ch> and calibration method ([SENSe<Ch>:]CORRection:COLLect:METhod). The analyzer test ports 1 or 2 are implicitly specified with the correction terms. The setting command can be used to transfer user-defined correction data to the analyzer; the query returns the current correction data set. ASCII or block data can be transferred, depending on the selected data transfer format (FORMat[:DATA])

The sweep must be stopped to transfer calibration data; see program example for [SENSe<Ch>:]CORRection:COLLect:SAVE:DEFault.

**Note:** This command affects the active calibration of channel no. <Ch> or the factory calibration (if no channel calibration is active). For the factory calibration, the query form is allowed only (no change of factory calibration data).

**Tip:** Use the generalized command [SENSe<Ch>:]CORRection:CDATa to transfer calibration data for arbitrary analyzer ports. The analyzer provides a default calibration corresponding to a test setup which does not introduce any systematic errors; see [SENSe<Ch>:]CORRection:COLLect:SAVE:DEFault.

**G and H matrices**

The 7-term calibration types named Txx (e.g. TOM, TSM, TRM, TRL, TNA) are based on a network analyzer with two ports i and j, each equipped with a test receiver and a reference receiver. The system errors are described in terms of two "error two-ports"  $P_G$  and  $P_H$ :

- The error two-port  $P_G$  is assigned to port i of the analyzer. Its transmission matrix  $G$  describes how the system errors modify the outgoing and incident waves at port i:

$$\begin{bmatrix} b_i \\ a_i \end{bmatrix} = \begin{bmatrix} G_{11} & G_{12} \\ G_{21} & G_{22} \end{bmatrix} * \begin{bmatrix} m_{i\text{ref}} \\ m_{i\text{test}} \end{bmatrix}$$

- The error two-port  $P_H$  is assigned to port j of the analyzer. Its transmission matrix  $H$  describes how the system errors modify the measured incident and outgoing waves at port j:

$$\begin{bmatrix} a_j \\ b_j \end{bmatrix} = \begin{bmatrix} H_{11} & H_{12} \\ H_{21} & H_{22} \end{bmatrix} * \begin{bmatrix} m_{j\text{test}} \\ m_{j\text{ref}} \end{bmatrix}$$

In the two equations above, a and b denote the waves at the calibrated reference plane i and j (e.g. the input and output of the 2-port DUT). The m waves are the raw measured waves of test port i and j. The subscripts "ref" and "test" refer to the reference and test receivers, respectively. During the calibration the network analyzer acquires ratios of wave quantities, which leaves one of non-diagonal matrix elements of G or H as a free normalization factor. The network analyzer uses the normalization  $H_{21} = 1$ .

**Suffix:**

<Ch> Channel number of the calibrated channel

**Parameters:**

&lt;ErrorTerm&gt;

String parameters describing the different error terms, depending on the current calibration method; see table below. Each term contains one complex value (real and imaginary part) for each sweep point. The parameters must be transferred in full length. The following strings are allowed:

'SCORR1' - directivity at port 1

'SCORR2' - source match at port 1

'SCORR3' - reflection tracking at port 1

'SCORR4' - reserved for future extensions

'SCORR5' - load match at port 2

'SCORR6' - forward transmission tracking between port 1 and port 2

'SCORR7' - directivity at port 2

'SCORR8' - source match at port 2

'SCORR9' - reflection tracking at port 2

'SCORR10' - reserved for future extensions

'SCORR11' - load match at port 1

'SCORR12' - reverse transmission tracking between port 2 and port 1

'G11' ... 'G22' - G matrix elements; see above

'H22' - H matrix elements; see above

The error terms are dimensionless complex numbers.

\*RST: n/a

&lt;Parameter&gt;

**Example:**See `[SENSe<Ch>:]CORRection:COLLect:SAVE:DEFault`

The different calibration types of the analyzer provide the following error terms:

| Calibration type                                           | Parameter in [SENSe<Ch>:]CORRection:COLLect:MEtHod | Available error terms (depending on port numbers)                                             |
|------------------------------------------------------------|----------------------------------------------------|-----------------------------------------------------------------------------------------------|
| One-port normalization (reflection) using an open standard | REFL1<br>REFL2<br>REFL12                           | 'SCORR3'<br>'SCORR9'<br>'SCORR3' and 'SCORR9'                                                 |
| Full one port                                              | FOPort1<br>FOPort2<br>FOPort12                     | 'SCORR1' to 'SCORR3'<br>'SCORR7' to 'SCORR9'<br>'SCORR1' to 'SCORR3' and 'SCORR7' to 'SCORR9' |
| Two-port normalization                                     | FTRans<br>RTRans<br>FRTRans                        | 'SCORR6'<br>'SCORR12'<br>'SCORR6' and 'SCORR12'                                               |
| One path two port                                          | FOPTport<br>ROPTport                               | 'SCORR1' to 'SCORR3', 'SCORR6'<br>'SCORR7' to 'SCORR9', 'SCORR12'                             |



| Calibration type        | Parameter in [SENSe<Ch>:]CORRection:COLLect:MEtHod | Available error terms (depending on port numbers)                                                                                                                                                            |
|-------------------------|----------------------------------------------------|--------------------------------------------------------------------------------------------------------------------------------------------------------------------------------------------------------------|
| TOSM                    | TOSM                                               | 'SCORR1' to 'SCORR12'<br>(at present the isolation terms 'SCORR4' and 'SCORR10' are not included)                                                                                                            |
| TOM, TSM, TRM, TRL, TNA | TOM   TRM   TRL   TNA                              | 'DIRECTIVITY', 'SRCMATCH', 'REFLTRACK', 'LOADMATCH', 'TRANSTRACK' (for reading and writing)<br><br>'G11' ... 'G22' and 'H11', 'H12', 'H22' (for reading only; the 'H21' matrix elements are normalized to 1) |

---

**[SENSe<Ch>:]CORRection:OFFSet<PhyPt>:MAGNitude <OffsetLoss>**

Defines the frequency-independent part (DC value) of the offset loss.

**Tip:** Use the [SENSe<Ch>:]CORRection:LOSS<PhyPt>... commands to define the complete set of loss offset parameters.

[SENSe<Ch>:]CORRection:OFFSet<PhyPt>:MAGNitude is equivalent to [SENSe<Ch>:]CORRection:LOSS<PhyPt>:OFFSet.

**Suffix:**

<Ch> Channel number of the offset-corrected channel

<PhyPt> Port number of the analyzer

**Parameters:**

<OffsetLoss> Frequency-independent part of the offset loss

Range: -200 dB to +200 dB

Increment: 0.0001 dB

\*RST: 0 dB

Default unit: dB

---

**[SENSe<Ch>:]FREQuency:MODE <FreqSweep>**

Selects the sweep type and defines which set of commands controls the stimulus frequency.

**Tip:** The command [SENSe<Ch>:]SWEep:TYPE provides a complete list of sweep types.

**Suffix:**

<Ch> Channel number

**Parameters:**

<FreqSweep> CW | FIXed | SWEep | SEGMENT

Linear or logarithmic frequency sweep, depending on the selected spacing ([SENSe<Ch>:]SWEep:SPACingLINear | LOGarithmic). The frequency range is set via [SENSe<Ch>:]FREQuency:START etc.

**Example:**

```
FREQ:MODE CW
Activate a time sweep.
FREQ: CW 100MHz
Set the CW frequency to 100 MHz.
```

---

### [SENSe<Ch>:]SEGMENT<Seg>:CLEAr

Deletes all sweep segments in the channel. The command is equivalent to [\[SENSe<Ch>:\]SEGMENT<Seg>:DELeTe:ALL](#).

**Suffix:**

<Ch> Channel number

<Seg> Sweep segment number. This suffix is ignored; the command deletes all segments.

**Usage:** Event

---

### [SENSe<Ch>:]SEGMENT<Seg>:OVERlap <Boolean>

Queries whether the analyzer supports overlapping sweep segments.

**Suffix:**

<Ch> Channel number. This suffix is ignored; the command is instrument-specific.

<Seg> Sweep segment number. This suffix is ignored; the command is instrument-specific.

**Parameters:**

<Boolean> ON | OFF: No effect.

\*RST: ON. If used as a query, the command returns the information that overlapping sweep segments are supported (ON).

---

### [SENSe<Ch>:]SWEep:SPACing <StimulusFreq>

Defines the frequency vs. time characteristics of a frequency sweep ("Lin Frequency" or "Log Frequency"). The command has no effect on segmented frequency, power or time sweeps.

**Note:** Use [\[SENSe<Ch>:\]SWEep:TYPE](#) to select sweep types other than "Lin Frequency" or "Log Frequency".

**Suffix:**

<Ch> Channel number

**Parameters:**

<StimulusFreq> LINear | LOGarithmic

The stimulus frequency is swept in equidistant steps over the frequency range. In a Cartesian diagram, the x-axis is a linear frequency axis.

**Example:**            `FUNC "XFR:POW:S12"`  
 Activate a frequency sweep and select the S-parameter  $S_{12}$  as measured parameter for channel and trace no. 1.  
`SWE:SPAC LOG`  
 Change to sweep type "Log Frequency".

---

### [SENSe<Chn>:]FUNcTion[:ON] <SweepType>

Defines the sweep type and the measurement parameter in a single string.

**Note:** To select a measurement parameter without changing the sweep type, use `CALCulate<Ch>:PARAmeter:MEASure`. Use the other commands in the `CALCulate<Ch>:PARAmeter...` subsystem to create or delete traces and select measurement parameters.

#### Suffix:

<Chn>                    Channel number used to identify the active trace. If `[SENSe<Chn>:]FUNcTion[:ON]` is not used as a query, the number must be 1.

#### Parameters:

<SweepType>            Single string parameter defining the sweep type and the parameter to be measured:

`<string> = "<sweep_type>:<parameter>"`.

Range:                See list of strings below.

\*RST:                "XFR:S21"

**Example:**            `CALC4:PAR:SDEF "Ch4Tr1", "S11"`  
 Create channel 4 and a trace named "Ch4Tr1" to measure the input reflection coefficient  $S_{11}$ . The trace automatically becomes the active trace.  
`SENS4:FUNC?`  
 Check (query) the sweep type and measurement parameter of the active trace. The result is 'XFR:POW:S11'.

The following keywords define the sweep type (see SCPI command reference: presentation layer):

|            |                                                                     |
|------------|---------------------------------------------------------------------|
| XFRequency | Frequency sweep (Lin. Frequency/Log. Frequency/Segmented Frequency) |
| XPOWer     | Power sweep                                                         |
| XTIME      | Time sweep                                                          |
| XCW?       | CW Mode sweep (output variable for query only)                      |

The following keywords define the measurement parameter (see SCPI command reference: function name):

|                                                                                   |                                                                                                                                           |
|-----------------------------------------------------------------------------------|-------------------------------------------------------------------------------------------------------------------------------------------|
| POWer:S<Ptout><Ptin>                                                              | S-parameter with output and input port number of the DUT, e.g. S <sub>11</sub> , S <sub>21</sub> .                                        |
| POWer:RATio A<Ptout>   B<Ptin>,<br>A<Ptout>   B<Ptin><br>Output: A<Ptout>/B<Ptin> | Ratio, e.g. B <sub>2</sub> , A <sub>1</sub> for b <sub>2</sub> /a <sub>1</sub> drive Port 1                                               |
| POWer:A<Ptout>                                                                    | Wave quantity with stimulus port number of the analyzer, e.g. a <sub>1</sub> .                                                            |
| POWer:B<Ptin>                                                                     | Wave quantity with receive port number of the analyzer, e.g. b <sub>2</sub> .                                                             |
| POWer:Z<Ptout><Ptin>                                                              | Matched-circuit impedance (converted Z-parameter) with output and input port number of the DUT, e.g. Z <sub>11</sub> , Z <sub>21</sub> .  |
| POWer:Y<Ptout><Ptin>                                                              | Matched-circuit admittance (converted Y-parameter) with output and input port number of the DUT, e.g. Y <sub>11</sub> , Y <sub>21</sub> . |
| POWer:KFACTOR<br>POWer:MUFactor<Lev>                                              | Stability factor K<br>Stability factors $\mu_1$ or $\mu_2$                                                                                |

**Note:** The mnemonics POWER: and VOLTage: are not used in output strings.

---

#### SOURce<Ch>:POWER<PhyPt>:CORRection:COLLEct[:ACQuire] <Sensor>

Initiates a source power calibration for the source port <PhyPt> using an external power meter no. 1 or 2. To initiate a source power calibration for arbitrary power meters, use the alternative commands listed in the program example below.

**Note:** The command cannot be used unless a power meter is connected via GPIB bus, USB or LAN interface and configured in the "External Power Meters" dialog.

#### Suffix:

<Ch>                      Calibrated channel number

<PhyPt>                  Calibrated port number

#### Setting parameters:

<Sensor>                ASENSor | BSENSor  
                               ASENSor – external power meter Pmtr 1.  
                               BSENSor – external power meter Pmtr 2.  
 \*RST:                    ASENSor

#### Example:

```
SOUR:POW3:CORR:COLL BSEN
Perform a source power calibration for port 3 using power meter
no. 2.
SOUR:POW:CORR:PMET:ID 2
Select power meter no. 2.
SOUR:POW:CORR:ACQ PORT,3
Perform a source power calibration for port 3 using the previ-
ously selected power meter no. 2.
```

**Usage:** Setting only  
**Manual operation:** See "Start Cal Sweep" on page 271

### TRACe:CLEar <MemTrace>

Deletes one of the memory traces `Mem<n> [Trc<m>]`, where `n = 1, ... 8`.

#### Setting parameters:

<MemTrace> MDATa1 | MDATa2 | MDATa3 | MDATa4 | MDATa5 | MDATa6 | MDATa7 | MDATa8

Identifier for the memory trace; see [Table 6-10](#).

Range: MDATA<n> where <n> = 1 to 8.

#### Example:

```
SWE:POIN 20
```

Create a trace with 20 sweep points, making the created trace the active trace of channel 1 (omitted optional mnemonic `SENSe1`).

```
TRAC:COPY "Mem_Pt20", CH1DATA
```

Copy the current state of the created trace to a memory trace named "Mem\_Pt20". The memory trace is not displayed.

```
DISP:WIND:TRAC2:FEED "MEM_PT20"
```

Display the created memory trace in the active diagram area (diagram area no. 1).

**Usage:** Setting only

### TRACe[:DATA][:RESPonse][:ALL]? <Response>

Returns the response values of the active data trace or memory trace (see [Table 6-10](#)).

**Note:** To read the response values of an arbitrary data or memory trace, use `CALCulate<Chn>:DATA`. To read the response values of a trace acquired in single sweep mode (`INITiate<Ch>:CONTinuousOFF`), use `CALCulate<Chn>:DATA:NSweep:FIRSt?`.

#### Query parameters:

<Response> CH1Data | CH2Data | CH3Data | CH4Data | CH1Mem | CH2Mem | CH3Mem | CH4Mem | MDATa1 | MDATa2 | MDATa3 | MDATa4 | MDATa5 | MDATa6 | MDATa7 | MDATa8

Response data of the selected trace, see [Table 6-10](#).

The data is transferred in the data format defined via `FORMat[:DATA]` and `FORMat:DEXPort:SOURce`. The unit is the default unit of the measured parameter; see `CALCulate<Ch>:PARAmeter:SDEFine`.

**Example:** `SWE:POIN 20`  
 Create a trace with 20 sweep points, making the created trace the active trace of channel 1 (omitted optional mnemonic `SENSe1`).  
`CALC:FORM MLIN; :FORM ASCII; FORM:DEXP:SOUR`  
`FDAT`  
 Select the trace data format: linear magnitude values, ASCII format and formatted trace data (1 value per sweep point).  
`TRAC? CH1DATA`  
 Query the 20 response values of the created trace according to the previous format settings.

**Usage:** Query only

### **TRACe[:DATA]:STIMulus[:ALL]? <Stimulus>**

Returns the stimulus values of the active data trace or memory trace (see [Table 6-10](#)).

**Note:** To read the stimulus values of an arbitrary data or memory trace, use `CALCulate<Chn>:DATA:STIMulus?`

#### **Query parameters:**

<Stimulus> CH1Data | CH2Data | CH3Data | CH4Data | CH1Mem | CH2Mem | CH3Mem | CH4Mem | MDATa1 | MDATa2 | MDATa3 | MDATa4 | MDATa5 | MDATa6 | MDATa7 | MDATa8  
 Stimulus data of the selected trace, see [Table 6-10](#).  
 The data is transferred in the data format defined via `FORMat [:DATA]`.

**Example:** `SWE:POIN 20`  
 Create a trace with 20 sweep points, making the created trace the active trace of channel 1 (omitted optional mnemonic `SENSe1`).  
`TRAC:STIM? CH1DATA`  
 Query the 20 stimulus values of the created trace. In the default format setting, the data is returned as a comma-separated list of 10-digit ASCII values.

**Usage:** Query only

# 7 Programming Examples

This chapter contains detailed programming examples on various tasks.

The syntax and use of all SCPI commands is described in [Chapter 6, "Command Reference"](#), on page 398, where you will also find additional examples. For a general introduction to remote control of the analyzer refer to [Chapter 5, "Remote Control"](#), on page 359. For an overview of special remote control features of the network analyzers refer to [Chapter 5.3, "Basic Remote Control Concepts"](#), on page 371.

## 7.1 Basic Tasks

This section presents detailed examples for programming tasks that almost every user will encounter when working with the R&S ZNC/ZND.

### 7.1.1 Typical Stages of a Remote Control Program

A typical remote control program comprises the following stages:

1. Performing the basic instrument settings
2. Adjusting the test setup
3. Initiating the measurement, command synchronization
4. Retrieving measurement results

Very often, steps 3 and 4 (or steps 2 to 4) must be repeated several times.



All example programs in this section have been developed and tested by means of the GPIB Explorer provided with the network analyzer. No extra programming environment is needed.

---

#### 7.1.1.1 Basic Instrument Settings

**Programming task:** Adjust the basic network analyzer settings to your measurement tasks, optimizing the instrument for fast measurements.



### Considerations for high measurement speed

The measurement speed depends on the sweep time but also on an efficient preparation of the instrument and on proper command synchronization. The following items should be kept in mind:

- For maximum speed the basic channel settings should be set while the sweep is stopped and with a minimum of sweep points. It is advisable to increase the number of points after all instrument settings have been performed, and to initiate the sweep after the test setup has been completed.
- Execution of the `INITiate[:IMMEDIATE]` command is fastest in synchronized mode. Insertion of fixed waiting periods into the command sequence is possible but generally less efficient.
- The sweep time depends on several parameters; see below. In particular it is recommended to select the best set of sweep points, e.g. using the segmented sweep.

```
// Reset the instrument, switch off the measurement (after one sweep),
// reduce the number of sweep points.
*RST
INITiate1:CONTinuous OFF
SENSe1:SWEep:POINts 2
//
// Avoid a delay time between different partial measurements and before the
// start of the sweeps (is default setting).
SENSe1:SWEep:TIME:AUTO ON
TRIGger1:SEQuence:SOURce IMMEDIATE
//
// Select the widest bandwidth compatible with your measurement.
SENSe1:BANDwidth:RESolution 10
//
// Adjust your sweep points to your measurement task, e.g. using a segmented sweep.
SENSe1:SEGMENT...
```

#### 7.1.1.2 Adjusting the Test Setup

In general the preparatives described above can be used for a series of measurements. In-between the measurements it is often necessary to change the test setup, e.g. in order to replace the DUT, change the connected ports, connect external devices etc.

#### 7.1.1.3 Start of the Measurement and Command Synchronization

Programming task: Start a measurement in single sweep mode. Wait until all single sweep data has been acquired before you proceed to the next stage of the measurement.

`INITiate<Ch>[:IMMEDIATE][:DUMMY]` OR `INITiate<Ch>[:IMMEDIATE]:ALL` are used to start a single sweep or a group of single sweeps. This commands have



been implemented for overlapped execution. The advantage of overlapped commands is that they allow the program to do other tasks while being executed.

In the present example the sweep must be completed before measurement results can be retrieved. To prevent wrong results (e.g. a mix-up of results from consecutive sweeps) the controller must synchronize its operation to the execution of `INITiate<Ch>[:IMMediate]`. IEEE 488.2 defines three common commands (`*WAI`, `*OPC?`, `*OPC`) for synchronization.

### // 1. Start single sweep, use \*WAI

```
// *WAI is the easiest method of synchronization. It has no effect when sent
// after sequential commands.
// If *WAI follows INITiate<Ch>[:IMMediate]... (overlapped commands), the analyzer
// executes no further commands or queries until the sweep is terminated.
// *WAI does prevent the controller from sending other commands to the analyzer
// or other devices

// Start single sweep in channel no. 1, wait until the end of the sweep
INITiate1:IMMediate; *WAI
<Continue program sequence>
```

### // 2. Start single sweep, use \*OPC?

```
// If *OPC follows INITiate<Ch>[:IMMediate]..., it places a 1 into the
// output queue when the sweep is terminated.
// An appropriate condition in the remote control program must cause the
// controller to wait until *OPC? returns one.
// The controller is stopped from the moment when the condition is set.

// Start single sweep in channel no. 1, indicate the end of the sweep
// by a 1 in the output queue.
INITiate1:IMMediate; *OPC?
// So far the controller may still send messages to other connected devices.

// Stop the controller until *OPC? returns one (program syntax depends
// on your programming environment).
<Condition OPC=1>
<Continue program sequence>
```

### // 3. Start single sweep, use \*OPC

```
// If *OPC follows INITiate<Ch>[:IMMediate]..., it sets the OPC bit in the ESR
// after the sweep is terminated.
// This event can be polled or used to trigger a service request of the analyzer.
// The advantage of *OPC synchronization is that both the controller and the
// analyzer can continue processing commands while the sweep is in progress.

// Enable a service request for the ESR
*SRE 32
// Set event enable bit for operation complete bit
```

```

*ESE 1
// Start single sweep in channel no. 1, set the OPC bit in the ESR
// after the sweep is terminated.
// The controller may still send messages, the analyzer continues to parse
// and execute commands.
INITiate1:IMMediate; *OPC

// Controller waits for service request from the analyzer
// (program syntax depends on your programming environment).
<Wait for service request>
<Continue program sequence>

```

#### 7.1.1.4 Retrieving Measurement Results

**Programming task:** Read the results acquired in a single sweep.

##### // 1. Read single values (-> Markers)

```

// Markers are the most convenient tool for determining and retrieving single
// values on traces.
// The analyzer provides up to ten markers; see Markers and Limit Lines.

```

##### // 2. Read complete trace

```

// Select a trace format and read formatted trace data.
CALCulate1:FORMat MLINear / Calculate the linear magnitude of z
CALCulate1:DATA? FDATA / Read the formatted trace data

```



Use `CALCulate<Chn>:DATA:NSweep:FIRSt?` to retrieve a particular trace within a group of sweeps.

## 7.1.2 Channel, Trace and Diagram Handling

The following examples show you how to perform basic tasks related to channel and trace definition and to the display of traces in diagrams.



All example programs in this section have been developed and tested by means of the GPIB Explorer provided with the network analyzer. No extra programming environment is needed.

#### 7.1.2.1 Several Traces with Equal Channel Settings

**Programming task:** Create up to four different traces with equal channel settings, assign the four 2-port standard S-parameters to the traces and display them in up to four diagrams.

**Important remote control features for this program example**

The following command sequence illustrates the structure of the remote commands discussed in section Basic Remote Control Concepts. In particular it shows that:

- A trace can be created and handled without being displayed.
- Traces are referenced by trace names. The active trace of a channel is often referenced by the channel suffix.
- Diagrams are referenced by a window suffix <Wnd>. An additional suffix <WndTr> in the DISPLAY:WINDOW<Wnd>:TRACE<WndTr>... commands numbers the different traces in a diagram.
- In remote control, it is possible to display the same trace in several diagrams.
- The analyzer provides several commands allowing a smooth transition between remote and manual control.

**// 1. One channel, two traces, one diagram**

```
// Reset the instrument, creating the default trace Trc1 in channel 1.
// The default measured quantity is the forward transmission S-parameter S21.
// The default format is dB Mag.
*RST

// Create a second trace in channel 1, assign the format Phase,
// and display the new trace in the same diagram.
// the trace becomes the active trace but is not displayed
CALCulate1:PARAMeter:SDEFine 'Trc2', 'S21'

// the trace is referenced by the channel suffix 1
CALCulate1:FORMat PHASE

// display the second trace, numbering it the second trace in diagram no. 1
DISPlay:WINDow1:TRACe2:FEED 'Trc2'
```

**// Check the result on the local screen**

```
// Go to local
SYSTem:DISPlay:UPDate ONCE
```

**// 2. One channel, two traces, two diagrams**

```
// Create a second diagram, assign Trc2 to the new area, and remove it
// from the first area.
DISPlay:WINDow2:STATe ON
DISPlay:WINDow2:TRACe2:FEED 'Trc2'
// Trc2 is now displayed in both diagrams
DISPlay:WINDow1:TRACe2:DELeTe
```

**// Check the result on the local screen**

```
// Go to local
SYSTem:DISPlay:UPDate ONCE
```

**// 3. One channel, four traces, four diagrams**

```
// Reset the instrument, add diagrams no. 2, 3, 4.
*RST; :DISPlay:WINDow2:STATe ON
DISPlay:WINDow3:STATe ON
DISPlay:WINDow4:STATe ON

// Assign the reflection parameter S11 to the default trace.
:CALCulatel:PARAmeter:MEASure 'Trc1', 'S11'

// Assign the remaining S-parameters to new traces Trc2, Trc3, Tr4;
// select the Smith chart format for the reflection parameters.
CALCulatel:FORMat SMITH // Smith chart for the active trace Trc1
CALCulatel:PARAmeter:SDEFine 'Trc2', 'S21'
CALCulatel:PARAmeter:SDEFine 'Trc3', 'S12'
CALCulatel:PARAmeter:SDEFine 'Trc4', 'S22'
// Smith chart for the active trace Trc4, referenced by the channel number
CALCulatel:FORMat SMITH

// Display the new traces in diagrams no. 2 to 4.
DISPlay:WINDow2:TRACe2:FEED 'Trc2'
DISPlay:WINDow3:TRACe3:FEED 'Trc3'
DISPlay:WINDow4:TRACe4:FEED 'Trc4'
```

**// Check the result on the local screen**

```
// Go to local
SYSTem:DISPlay:UPDate ONCE
```

**7.1.2.2 Several Traces with Different Channel Settings...**

**Programming task:** Create three channels with 3, 1 and 2 traces, respectively, and display the traces in two diagrams.

**Important remote control features for this program example**

The following command sequence illustrates the structure of the remote commands discussed in section Basic Remote Control Concepts. In particular it shows that:

1. Channels are always referenced by a channel suffix.
2. Traces are referenced by trace names. The active trace of a channel is often referenced by the channel suffix.
3. Diagrams are referenced by a window suffix <Wnd>. An additional suffix <WndTr> in the `DISPlay:WINDow<Wnd>:TRACe<WndTr>...` commands numbers the different traces in a diagram.
4. The analyzer provides several commands allowing a smooth transition between remote and manual control.

**// 1. Create all channels and traces**

```
// Reset the instrument, creating the default trace Trc1 in channel 1.
// The default measured quantity is the forward transmission S-parameter S21.
// The default format is dB Mag.
*RST

// Create two more traces in channel 1, assigning a trace name and a measured
// quantity to each of them. Choose descriptive trace names (instead of the
// short default names used above).
CALCulate1:PARAMeter:SDEFine 'Impedance_trace', 'Z-S21'
// the trace becomes the active trace for channel 1 but is not displayed

CALCulate1:PARAMeter:SDEFine 'Admittance_trace', 'Y-S21'
// the trace becomes the active trace for channel 1

// Create channel 2 with one new trace, channel 3 with two new traces.
CALCulate2:PARAMeter:SDEFine 'Ratio_trace', 'B1/B2'
CALCulate3:PARAMeter:SDEFine 'Z_trace', 'Z21'
CALCulate3:PARAMeter:SDEFine 'Y_trace', 'Y21'
CALCulate3:PARAMeter:SElect 'Z_trace'
// the trace created previously becomes the active trace for channel 3
// So far, only the default trace is displayed.
```

**// Check the result on the local screen**

```
// Go to local
SYSTem:DISPlay:UPDate ONCE
```

**// 2. Create second diagram and display traces**

```
DISPlay:WINDow2:STATe ON
DISPlay:WINDow1:TRACe2:FEED 'Admittance_trace'
DISPlay:WINDow1:TRACe3:FEED 'Y_trace'
DISPlay:WINDow2:TRACe1:FEED 'Impedance_trace'
DISPlay:WINDow2:TRACe2:FEED 'Ratio_trace'
DISPlay:WINDow2:TRACe3:FEED 'Z_trace'
```

**// Check the result on the local screen**

```
// Go to local
SYSTem:DISPlay:UPDate ONCE
```

**// 3. Check and modify your configuration**

```
// Query the traces in channel 1.
CALCulate1:PARAMeter:CATalog?
// The response is 'Trc1,S21,Impedance_trace,Z-S21,Admittance_trace,Y-S21'

// Query the reference level for the 'Z_trace'.
// The trace is referenced by its number in diagram no. 2.
DISPlay:WINDow2:TRACe3:Y:RLEVEL?
```

```
// Change the display format for the 'Z_trace'. The trace is the active trace
// in channel 3, so it is referenced by the channel suffix 3.
// Update the display
CALCulate3:FORMat PHASE
// Update the display
SYSTem:DISPlay:UPDate ONCE
```

### 7.1.2.3 Markers and Limit Lines...

**Programming task:** Display two traces in a single diagram area, use markers to read results, and perform a limit check.

#### Important remote control features for this program example

The following command sequence illustrates the structure of the remote commands discussed in section Basic Remote Control Concepts. In particular it shows that:

1. Traces are referenced by trace names. The active trace of a channel is often referenced by the channel suffix. This simplifies the program syntax, e.g. in the commands for marker settings and for the limit check.
2. Diagrams are referenced by a window suffix <Wnd>. An additional suffix <WndTr> in the DISPLAY:WINDOW<Wnd>:TRACE<WndTr>... commands numbers the different traces in a diagram.
3. The analyzer provides several commands allowing a smooth transition between remote and manual control.

#### // 1. Create one channel, two traces, one diagram

```
// Reset the instrument, creating the default trace Trc1 in channel 1.
// The default measured quantity is the forward transmission S-parameter S21.
// The default format is dB Mag.
*RST

// Create a second trace in channel 1, assign the format Phase,
// and display the new trace in the same diagram.

// the trace becomes the active trace but is not displayed
CALCulate1:PARAMeter:SDEFine 'Trc2', 'S21'

// the trace is referenced by the channel suffix 1
CALCulate1:FORMat PHASE

// display the second trace, numbering it the second trace in diagram no. 1
DISPlay:WINDOW1:TRACE2:FEED 'Trc2'
```

#### // Check the result on the local screen

```
// Go to local
SYSTem:DISPlay:UPDate ONCE
```

**// 2. Marker settings**

```
// Adjust the sweep range to consider an interesting segment of the trace and
// re-scale the diagram.
SENSE1:FREQUENCY:START 4.5 GHz; STOP 5.5 GHz
// in the autoscale command the trace is referenced by its number in the diagram
DISPLAY:WINDOW1:TRACE1:Y:SCALE:AUTO ONCE

// Select trace Trc1 as the active trace of the channel, define a reference
// marker and a delta marker.
// In the marker commands the active trace is referenced by the channel suffix.
CALCULATE1:PARAMETER:SELECT 'Trc1'

// the marker is set to the center of the sweep range
CALCULATE1:MARKER1:STATE ON

// this command also creates the reference marker
CALCULATE1:MARKER1:DELTA:STATE ON

// set the reference marker to the beginning of the sweep range
CALCULATE1:MARKER1:REFERENCE:X 4.5 GHz

// Use the delta marker to search for the minimum of the trace and query the result.
// the query returns the stimulus and the response value at the marker position
CALCULATE1:MARKER1:FUNCTION:EXECUTE MIN; RES?
```

**// Check the result on the local screen**

```
// Go to local
SYSTEM:DISPLAY:UPDATE ONCE
```



Use the `CALCULATE<Chn>:DATA...` commands to retrieve the complete trace; see [Retrieving Measurement Results](#).

**// 3. Limit lines and limit check**

```
// Remove all markers and define a limit line for the active trace.
CALCULATE1:MARKER1:AOFF
// define an upper limit line across the entire sweep range
CALCULATE1:LIMIT:DATA 1, 4500000000, 5500000000, -5, -5
CALCULATE1:LIMIT:DATA 2, 4500000000, 5000000000, -10, -15
// define two segments for the lower limit line
CALCULATE1:LIMIT:DATA 2, 5000000000, 5500000000, -15, -10

// Display the limit line and perform the limit check.
CALCULATE1:LIMIT:DISPLAY:STATE ON
CALCULATE1:LIMIT:STATE ON; FAIL?
// if the trace failed the limit check; the response is 1
```

**// Check the result on the local screen**

```
// Go to local
SYSTem:DISPlay:UPDate ONCE
```

## 7.2 Condensed Programming Examples

This section contains short program examples for select issues. The comments have been commented in concise style; for more detailed information on the commands refer to [Chapter 6.3, "SCPI Command Reference"](#), on page 401.

If the example you are looking for is not in this section, we suggest you to refer to the short command sequences in the reference chapter. Proceed as follows:

1. Find your subject in the help system, preferably using context-sensitivity (of the help system on your network analyzer) or the index:

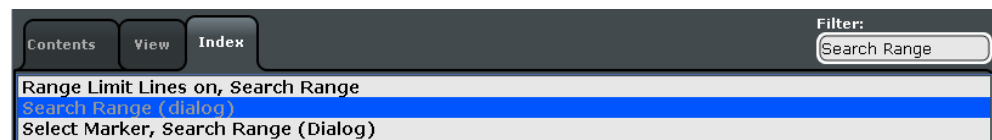

2. Activate the link to the command description:

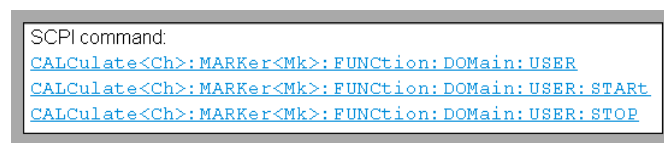

3. A short example appears at the end of each command description:

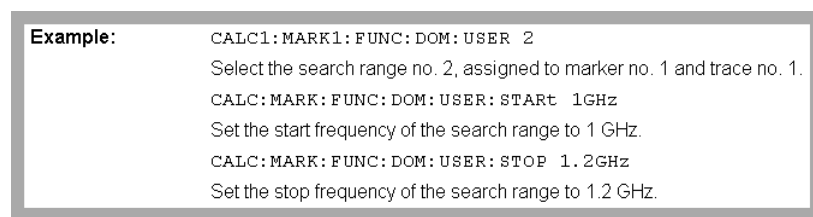

The command `SYSTem:DISPlay:UPDate` precedes some of the command scripts so that you can watch the progress of the script on the screen. For maximum performance, simply omit this command.

### 7.2.1 Path Independent RC Programs

The default directory for R&S ZNC/ZND user data is

`C:\Users\Public\Documents\Rohde-Schwarz\Vna`. Other instruments may use different default directories. To make remote control programs compatible, it is recom-



mended to define all paths relative to the default directory, to be set via  
 MMEemory:CDIRectory DEFault.

#### // Select default directory, change to sub-directory (relative to default directory)

```
MMEemory:CDIRectory DEFault
MMEemory:CDIRectory 'Traces'

MMEemory:STORE:TRACe 'Trc1', 'S21.slp'
MMEemory:LOAD:TRACe 'Trc1', 'S21.slp'
```

#### // Alternative, more compact definition

```
MMEemory:CDIRectory DEFault
MMEemory:STORE:TRACe 'Trc1', 'Traces\S21.slp'
```

You may also read the default path (MMEemory:CDIRectory?) and use the external RC program to build the complete paths.

## 7.2.2 Trace and Diagram Handling

The following sections provide examples for efficient channel and trace definition and convenient diagram handling.

### 7.2.2.1 Assigning Channels, Traces, and Diagrams

The following example is a short version of [Chapter 7.1.2, "Channel, Trace and Diagram Handling"](#), on page 770.

#### // Reset the analyzer

```
*RST
:SYSTEM:DISPLAY:UPDATE ON
```

#### // Create a new trace for S21 with the name TrcDisp

```
:CALCULATE1:PARAMETER:SDEFINE "TrcDisp","S21"
// Display the trace in the display area 1
:DISPLAY:WINDOW1:TRACE9:FEED 'TrcDisp'
:DISPLAY:WINDOW1:TRACE9:DELETE
```

#### // List the traces, assigned to a certain Channel

```
// format "<trace name>,<meas param>[,<trace name>,<meas param>...]"
:CALCULATE1:PARAMETER:CATALOG?
```

#### // Channel 4 does not exist, a new channel and trace is created

```
:CALCULATE4:PARAMETER:SDEFINE "Ch4Trc2","S22"
:CALCULATE4:PARAMETER:SDEFINE "Ch4Trc3","S33"
:CALCULATE4:PARAMETER:CATALOG?
```

**// Select active traces for channel 4**

```
:CALCULATE4:PARAMETER:SELECT "Ch4Trc2"
:CALCULATE4:PARAMETER:SELECT?
//:CALCULATE4:FORMAT POLAR
:CALCULATE4:PARAMETER:SELECT "Ch4Trc3"
//:CALCULATE4:FORMAT DB_LIN
:CALCULATE4:PARAMETER:SELECT?
:CALCULATE4:PARAMETER:SELECT "Ch4Trc2"
:CALCULATE4:FORMAT?
:CALCULATE4:PARAMETER:SELECT "Ch4Trc3"
:CALCULATE4:FORMAT?
```

**// Create trace**

```
:CALCULATE1:PARAMETER:SDEFINE "Trc2","S21"
:CALCULATE1:PARAMETER:SDEFINE "Trc3","S31"
:CALCULATE1:PARAMETER:CATALOG?
```

**// Delete trace**

```
:CALCULATE1:PARAMETER:DELETE "Trc2"
:CALCULATE1:PARAMETER:CATALOG?
```

**// Assign a trace to a window = diagram, diagram 1 always exists**

```
:DISPLAY:WINDOW1:TRACE2:FEED 'TrcDisp'
```

**// Create diagram 2**

```
:DISPLAY:WINDOW2:STATE?
:DISPLAY:WINDOW2:STATE ON
:DISPLAY:WINDOW2:STATE?
:DISPLAY:WINDOW2:TRACE6:FEED 'Ch4Trc2'
:DISPLAY:WINDOW2:TRACE2:FEED 'Trc1'
:DISPLAY:WINDOW2:TRACE3:FEED 'Ch4Trc3'
```

**// Create traces: trace names are not case sensitive**

```
:CALCULATE4:PARAMETER:SELECT "Ch4Trc2"
:CALCULATE4:PARAMETER:SELECT?
:CALCULATE4:PARAMETER:SELECT "CH4TRC3"
:CALCULATE4:PARAMETER:SELECT?
:CALCULATE4:PARAMETER:SELECT "ch4trc2"
:CALCULATE4:PARAMETER:SELECT?
```

**7.2.2.2 Memory Traces**

The following example shows how to save data to memory and work with memory traces.

**// Reset the analyzer**

```
*RST
:SYSTEM:DISPLAY:UPDATE ON

:SENSE1:SWEEP:POINTS 20
```

**// Create memory trace of the "active" trace (active for the parser !)**

```
// the name of the created memory trace is "Mem2[Trc1]"
:TRACE:COPY MDATA2,CH1DATA
:SENSE1:FUNCTION:ON 'XFREQUENCY:POWER:S11'
:CALCULATE1:PARAMETER:CATALOG?

// Assign the memory trace to a window = diagram, diagram 1 always exists
:DISPLAY:WINDOW1:TRACE2:FEED 'Mem2[Trc1]'
```

**// Create further memory traces and assign them to a window**

```
:TRACE:COPY 'Mem3x[Trc1]',CH1DATA // mixed parameters String, Char
:DISPLAY:WINDOW1:TRACE3:FEED 'Mem3x[Trc1]'
:TRACE:COPY MDATA4,CH1DATA
:DISPLAY:WINDOW1:TRACE4:FEED 'Mem4[Trc1]'
```

**// Create new normal trace on channel 1, assign it to a window**

```
:CALCULATE1:PARAMETER:SDEFINE "Trc2","S22"
:DISPLAY:WINDOW1:TRACE5:FEED 'Trc2'
:CALCULATE1:PARAMETER:SELECT 'Trc2' // now active for channel 1
:CALCULATE1:PARAMETER:SELECT?
:CALCULATE1:PARAMETER:CATALOG?
```

**// Create memory trace for 'Trc2',**

```
// The memory trace can be assigned to the diagram of the mother trace only
// (diagram 1)
:TRACE:COPY MDATA6,CH1DATA
:DISPLAY:WINDOW1:TRACE6:FEED 'Mem6[Trc2]'
```

**// Create new diagram 2 and new channel and trace**

```
:DISPLAY:WINDOW2:STATE ON
:CALCULATE2:PARAMETER:SDEFINE "Ch2Trc1","S22"
:CALCULATE2:PARAMETER:SELECT 'Ch2Trc1' // now active for channel 2
:SENSE1:SWEEP:POINTS 21
:TRACE:COPY MDATA1,CH2DATA
:DISPLAY:WINDOW2:TRACE7:FEED 'Mem1[Ch2Trc1]'
:TRACE:DATA:STIMULUS? CH1DATA
:TRACE:DATA:RESPONSE? MDATA6
```

**// Create new channel 3 and new trace**

```
:CALCULATE3:PARAMETER:SDEFINE "Ch3Trc1","S21"
:CALCULATE3:PARAMETER:SELECT 'Ch3Trc1' // now active for channel 3
:CALCULATE3:PARAMETER:SELECT? '%Ch3Trc1'
:SENSE1:SWEEP:POINTS 22
:TRACE:COPY MDATA8,CH3DATA
:TRACE:COPY MDATA7,CH3DATA
:DISPLAY:WINDOW2:TRACE1:FEED 'Mem8[Ch3Trc1]'
:TRACE:DATA:RESPONSE? MDATA7 // assigned to no diagram
```

**// Copy with arbitrary trace names, no blanks in trace names !!!**

```
:TRACE:COPY 'Trace_Name','Ch3Trc1'
:DISPLAY:WINDOW2:TRACE2:FEED 'Trace_Name'
:CALCULATE3:PARAMETER:SELECT 'Trace_Name'
:CALCULATE3:PARAMETER:SELECT?
:TRACE:COPY 'XYZ','Ch2Trc1'
:DISPLAY:WINDOW2:TRACE3:FEED 'XYZ'
:CALCULATE2:PARAMETER:SELECT 'XYZ'
:CALCULATE2:PARAMETER:SELECT?
:TRACE:COPY MDATA4 ,'Ch3Trc1' // mixed parameters Char, String
:DISPLAY:WINDOW2:TRACE4:FEED 'Mem4[Ch3Trc1]'
```

**// Copy to existing memory traces = update trace data**

```
:TRACE:COPY MDATA6,CH1DATA
:TRACE:COPY 'XYZ','Ch2Trc1'
:CALCULATE1:PARAMETER:CATALOG?
:CALCULATE2:PARAMETER:CATALOG?
:CALCULATE3:PARAMETER:CATALOG?
```

**7.2.2.3 Trace Mathematics**

The following script shows how to define mathematical relations between traces.

**// Reset the analyzer**

```
*RST
:SYSTEM:DISPLAY:UPDATE ON
```

**// Create memory trace on active trace of channel 1,**

```
// assign the memory trace to a diagram
:CALCULATE1:MATH:MEMORIZE
:DISPLAY:WINDOW1:TRACE2:FEED 'Mem2[Trc1]'
```

**// Define simple trace mathematics**

```
:CALCULATE1:MATH:FUNCTION ADD
:CALCULATE1:MATH:FUNCTION?
// Trace mathematics off
```

```
:CALCULATE1:MATH:FUNCTION NORMAL
:CALCULATE1:MATH:FUNCTION?
*RST
```

### // Create Trc2 in channel 1 and display it in diagram 1

```
:CALCULATE1:PARAMETER:SDEFINE "Trc2","S11"
:DISPLAY:WINDOW1:TRACE2:FEED 'Trc2'
```

### // Create diagram 2 and Trc3 in new channel

```
:DISPLAY:WINDOW2:STATE ON
:CALCULATE2:PARAMETER:SDEFINE "Trc3","S11"
:DISPLAY:WINDOW2:TRACE1:FEED 'Trc3'
```

### // Select active traces for channels 1 and 2

```
:CALCULATE1:PARAMETER:SELECT "Trc1"
:CALCULATE2:PARAMETER:SELECT "Trc3"
```

### // Create memory trace on Trc1 and assign it to a diagram, same for TRC3

```
:TRACE:COPY MDATA7,CH1DATA
:DISPLAY:WINDOW1:TRACE3:FEED 'Mem7[Trc1]'
:TRACE:COPY MDATA8,CH2DATA
:DISPLAY:WINDOW2:TRACE2:FEED 'Mem8[Trc3]'
```

### // Examples for Trace Mathematics

```
// Special operands Data and Mem
:CALCULATE1:MATH:SDEFINE "Data * Mem"
:CALCULATE1:MATH:STATE ON
// Constants
:CALCULATE1:MATH:SDEFINE "Pi * e * j"
// Functions
:CALCULATE1:MATH:SDEFINE "linMag (1) + dBMag (2) + Arg (3) + Re (4) + Im (5j)"
:CALCULATE1:MATH:SDEFINE "log (2) * ln (3) * Min (1, 2) * Max (2, 3)"
:CALCULATE1:MATH:SDEFINE "StimVal + asin (sin (3)) + acos (cos (4))
+ atan (tan (4))"
:CALCULATE1:MATH:SDEFINE "(Trc1 + 2) * 1.1"
:CALCULATE1:MATH:SDEFINE "(tRC1 + e) * Pi + STIMVAL - sin (1) + Min (TRC1, Trc1)"
// Imaginary unit j = sqrt (-1)
// j is no ordinary operand: 1j not 1 * j
// magnitude: 1, phase: 60 degrees
:CALCULATE1:MATH:SDEFINE "(1 + 3 ^ (1 / 2) * 1j) / 2"
:CALCULATE1:MATH:SDEFINE "sin (1) + ACOS (0.5)"
// 2 periods for sin (), ... when stop frequency 8 GHz = 8e9 Hz
:CALCULATE1:MATH:SDEFINE "sin (2 * 2 * Pi * StimVal / 8e9) "
:CALCULATE1:MATH:SDEFINE "cos (2 * 2 * Pi * StimVal / 8e9) "
:CALCULATE1:MATH:SDEFINE "tan (2 * 2 * Pi * StimVal / 8e9) "
:CALCULATE1:MATH:SDEFINE "Min (sin (6 * Pi * StimVal / 8e9),
cos (6 * Pi * StimVal / 8e9))"
```

```

:CALCULATE1:MATH:SDEFINE "Max (sin (6 * Pi * StimVal / 8e9),
      cos (6 * Pi * StimVal / 8e9))"
:CALCULATE1:MATH:SDEFINE "Trc1 ^ 2"
:CALCULATE1:MATH:SDEFINE "Trc1 + Trc2 + Trc3"
:CALCULATE1:MATH:SDEFINE "(Trc1 + e) * Pi + Mem8[Trc3] + StimVal
      + Min (Trc1, Mem7[Trc1])"
:CALCULATE1:MATH:SDEFINE "tan (5 * 2 * Pi * StimVal / 8e9)"

```

#### 7.2.2.4 Trace Statistics

The following script shows how to create a trace, select an evaluation range and retrieve statistical results.

##### // Reset the analyzer

```

*RST
:SYSTEM:DISPLAY:UPDATE ON

```

##### // Create new channel and trace

```

:CALCULATE2:PARAMETER:SDEFINE 'Trc2', 'S11'
:CALCULATE2:PARAMETER:SELECT 'Trc2'
:DISPLAY:WINDOW2:STATE ON
:DISPLAY:WINDOW2:TRACE1:FEED 'Trc2'
:SENSE1:SWEEP:TIME:AUTO ON
:SENSE2:SWEEP:TIME:AUTO ON

```

##### // Search full-span evaluation range, display statistical results

```

:CALCulate1:STATistics:DOMain:USER 0
:CALCulate2:STATistics:DOMain:USER 0
:CALCULATE1:STATISTICS ON
:CALCULATE2:STATISTICS ON

```

##### // Single sweep, global scope

```

:INITIATE:CONTINUOUS OFF
:INITIATE:IMMEDIATE:SCOPE ALL
:SENSE:SWEEP:COUNT 4
:INITIATE:IMMEDIATE; *WAI

```

##### // Calculate statistical results (also possible if info field is switched off)

```

:CALCULATE1:STATISTICS:RESULT? MEAN
:CALCulate1:STATistics:RESult? ELENgth
:CALCULATE1:STATISTICS:RESULT? ALL

```

##### // Modify evaluation range (is automatically confined to sweep range)

```

:CALCulate1:STATistics:DOMain:USER 1
:CALCulate1:STATistics:DOMain:USER:START 0 HZ

```

```
:CALCulate1:STATistics:DOMain:USER:STOP 100 GHZ
:CALCulate1:STATISTICS:RESULT? MEAN
:CALCulate1:STATISTICS:RESULT? MAX
```

### 7.2.2.5 Bandfilter Search

The following example shows how to use markers for a bandpass or bandstop search.

#### // Reset the analyzer

```
*RST
:SYSTEM:DISPLAY:UPDATE ON
:SENSE1:FREQUENCY:START 1 GHZ
:SENSE1:FREQUENCY:STOP 6 GHZ
```

#### // Bandpass search ref. to max.

```
:CALCulate1:MARKer:FUNCTion:BWIDth:MODE BPASs
:CALCulate1:MARKer:FUNCTion:BWIDth:MODE? %BPAS
// Measure single sweep, wait until complete sweep is finished
:INITiate:CONTinuous OFF
:INITiate; *WAI;
:CALCulate1:MARKer:FUNCTion:EXECute BFILter
// All markers OFF
:CALCulate1:MARKer:AOFF
```

#### // Bandpass search ref. to marker

```
:CALCulate1:MARKer1:STATe ON
:CALCulate1:MARKer1:X 3.0 GHz
:CALCulate1:MARKer:FUNCTion:BWIDth:MODE BPRMarker
:CALCulate1:MARKer:FUNCTion:BWIDth:MODE? %BPRM
:INITiate; *WAI;
:CALCulate1:MARKer:FUNCTion:EXECute BFILter
:CALCulate1:MARKer:AOFF
```

#### // Bandstop search ref. to max.

```
:CALCulate1:MARKer:FUNCTion:BWIDth:MODE BStOp
:CALCulate1:MARKer:FUNCTion:BWIDth:MODE? %BST
:INITiate; *WAI;
:CALCulate1:MARKer:FUNCTion:EXECute BFILter
:CALCulate1:MARKer:AOFF
```

#### // Bandstop search ref. to marker

```
:CALCulate1:MARKer1:STATe ON
:CALCulate1:MARKer1:X 1.7 GHz
:CALCulate1:MARKer:FUNCTion:BWIDth:MODE BsRMarker
```

```
:CALCulate1:MARKer:FUNCTION:BWIDth:MODE? %BsRM
:INITiate; *WAI;
:CALCulate1:MARKer:FUNCTION:EXECute BFILter
```

### 7.2.2.6 Creating Diagrams

In the following example, remote control commands are used to position several diagrams on the screen. The remote control commands presented here extend the functionality of the "Display > Diagram" and "Display > Split" softtool tabs.

#### // Reset the analyzer

```
*RST
:SYSTEM:DISPLAY:UPDATE ON
```

#### // Define and display a simple horizontal layout (two diagrams side by side)

```
:DISPlay:LAYout:DEFine 1, Horizontal, '1.00,0.30,0.70'
:DISPlay:LAYout:APPLY 1
```

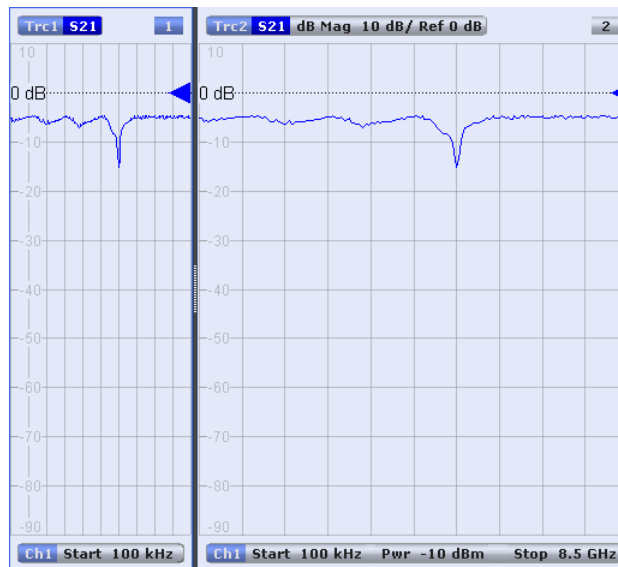

#### // Define and display a simple vertical layout (two diagrams, one on top of the other)

```
:DISPlay:LAYout:DEFine 2, Vertical, '1.00,0.50,0.50'
:DISPlay:LAYout:APPLY 2
```



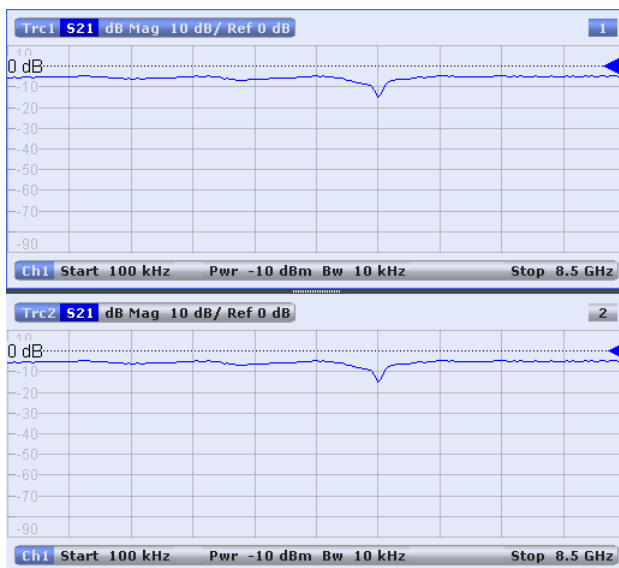

// Check the executable formats of the generated layouts

```
:DISPlay:LAYout:DEFine? 1 %(1,1,0.00,0.00,(1,2,1.00,1.00,[0.30,1.00],[0.70,1.00]))
:DISPlay:LAYout:DEFine? 2 %(1,1,0.00,0.00,(2,1,1.00,1.00,[1.00,0.50],[1.00,0.50]))
```

// Join the 2 layouts, display the nested layout

```
:DISPlay:LAYout:JOIN 1,2,2
:DISPlay:LAYout:APPLY 1
```

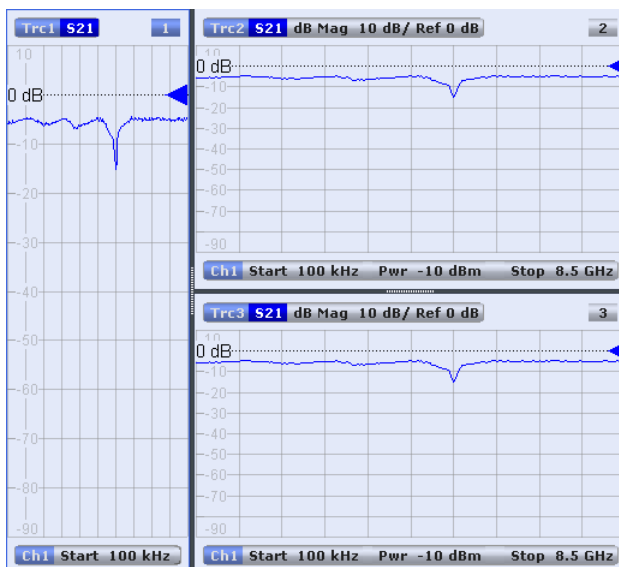

// Check the last applied (i.e. the joined) layout for the correct format

```
:DISPlay:LAYout:EXECute?
    %(1,1,0.00,0.00,(1,2,1.00,1.00,[0.30,1.00],
    %(1,1,0.70,1.00,(2,1,1.00,1.00,[1.00,0.50],[1.00,0.50])))
```

**// Set the layout format directly (horizontal, joined layout)**

```
:DISPlay:LAYout:EXECute
  '(1,1,0.00,0.00,(1,2,1.00,1.00,[0.30,1.00],
    (1,1,0.70,1.00,(2,1,1.00,1.00,[1.00,0.50],[1.00,0.50])))')'
```

**// Alternative direct definition of the joined layout as a vertical layout**

```
:DISPlay:LAYout:DEFine 3, VERT, '0.3,1.0;0.7,0.5,0.5'
:DISPlay:LAYout:APPLy 3
:DISPlay:LAYout:EXECute?
  %(1,2,0.00,0.00,(1,1,0.3,1.00,[1.00,1.0]),(2,1,0.7,1.00,[1.00,0.5],[1.00,0.5]))
```

### 7.2.3 Using Markers

The following example shows you how to define markers and use them to read trace values.

**// Reset the analyzer**

```
*RST
:SYSTEM:DISPLAY:UPDATE ON
```

**// Initiate a single sweep**

```
:INITiate1:CONTinuous OFF
:INITiate1:IMMediate;*WAI

// The following marker commands have the channel no. as a numeric suffix.
// The parameter belongs to a trace, the assignment channel -> trace
// is done via a "active" trace for each channel
:CALCULATE1:PARAMETER:SELECT 'Trc1'
```

**// Marker ON / OFF**

```
:CALCULATE1:MARKER1 ON
:CALCULATE1:MARKER1:STATE?
```

**// Coupled Markers**

```
// All markers belonging to channels with the same sweep type
// (FREQUENCY, TIME, POWER, CW FREQUENCY) are coupled/decoupled
:CALCULATE1:MARKER:COUPLED ON
```

**// Marker Continuous / Discrete**

```
:CALCULATE1:MARKER1:MODE CONTINUOUS
```

**// Normal / Delta / Reference / Fixed Marker**

```
:CALCULATE1:MARKER:AOFF // all markers off
:CALCULATE1:MARKER1 ON
:CALCULATE1:MARKER1:X 1GHZ
```

```

:CALCULATE1:MARKER2 ON
:CALCULATE1:MARKER2:X 2GHZ
:CALCULATE1:MARKER3 ON
:CALCULATE1:MARKER3:X 3GHZ
:CALCULATE1:MARKER4:DELTA:STATE ON
:CALCULATE1:MARKER:REFERENCE ON
:CALCULATE1:MARKER:REFERENCE:X 5GHZ
:CALCULATE1:MARKER1:TYPE FIXED

```

### // Query marker response values

```

:CALCULATE1:FORMAT MLINEAR
:CALCULATE1:MARKER1 ON
:CALCULATE1:MARKER1:X DEF
:CALCULATE1:MARKER1:FORMAT MLINEAR
// DataBase EMarkerFormat::LIN_MAG
:CALCULATE1:MARKER1:Y?
:CALCULATE1:MARKER1:FORMAT MLOGARITHMIC
//          . . . . . DB_MAG
:CALCULATE1:MARKER1:Y?

```

## 7.2.3.1 Marker Search Functions

The following example shows how to search for particular measurement points using markers.

### // Reset the analyzer

```

*RST
:DISPlay:WINDow1:TITLe:DATA 'Max Hold Function Emulation'

```

### // Define marker and stimulus range

```

:CALCULATE1:MARKER1 ON
:SENSE1:FREQUENCY:START 1GHZ
:SENSE1:FREQUENCY:STOP 2GHZ
// Do the marker search in the format DB Magnitude
:CALCULATE1:FORMAT MLOGARITHMIC

```

### // Define marker search ranges (stimulus range of the marker search)

```

// Range 0 is always the stimulus range of the trace (can't be changed)
:CALCULATE1:MARKER1:FUNCTION:DOMAIN:USER 0
:CALCulate1:MARKer1:FUNCTION:DOMain:USER:START?
:CALCulate1:MARKer1:FUNCTION:DOMain:USER:STOP?

// Range 1 (within the stimulus range)
:CALCULATE1:MARKER1:FUNCTION:DOMAIN:USER 1
:CALCulate1:MARKer1:FUNCTION:DOMain:USER:START 1.2GHZ
:CALCulate1:MARKer1:FUNCTION:DOMain:USER:STOP 1.8GHZ

```

```
// Range 2 (includes the stimulus range)
:CALCULATE1:MARKER1:FUNCTION:DOMAIN:USER 2
:CALCulate1:MARKer1:FUNction:DOMain:USER:START 0.8GHZ
:CALCulate1:MARKer1:FUNction:DOMain:USER:STOP 2.2GHZ

// Use range 0 (stimulus range of the trace)
:CALCULATE1:MARKER1:FUNCTION:DOMAIN:USER 0
```

#### // Select linear magnitude scale for diagram

```
:CALCULATE1:FORMAT MLINEAR
```

#### // Search for global minimum and maximum (MIN, MAX)

```
// (initial marker value may be inside or outside the marker search range)
:CALCULATE1:MARKER1:X 1.5GHZ
:CALCULATE1:MARKER:MIN
:CALCULATE1:MARKER1:X?

:CALCULATE1:MARKER1:X 1.5GHZ
:CALCULATE1:MARKER:MAX
:CALCULATE1:MARKER1:X?
```

#### // Minimum peak search functions

```
:CALCULATE1:MARKER1:FUNCTION:SELECT MINIMUM
:CALCULATE1:MARKER1:FUNCTION:SELECT?
// NEXT PEAK
:CALCULATE1:MARKER1:X 1.5GHZ
:CALCULATE1:MARKER:SEARCH:NEXT
:CALCULATE1:MARKER1:X?
// PEAK RIGHT
:CALCULATE1:MARKER1:X 1.5GHZ
:CALCULATE1:MARKER:SEARCH:RIGHT
:CALCULATE1:MARKER1:X?
// PEAK LEFT
:CALCULATE1:MARKER1:X 1.5GHZ
:CALCULATE1:MARKER:SEARCH:LEFT
:CALCULATE1:MARKER1:X?
```

#### // Maximum peak search functions

```
:CALCULATE1:MARKER1:FUNCTION:SELECT MAXIMUM
// Proceed as for minimum search
```

## 7.2.4 Data Handling

The following sections provide examples for efficient sweep definition and data handling. Part of the functionality is not available in manual control.

### 7.2.4.1 Single Sweep Mode

The commands `CALCulate<Ch>:DATA:NSweep...? SDATA,` `<Trace_Hist_Count>` retrieve the results of any sweep within a previously defined single sweep group. This means that, in single sweep mode, you can first measure a specified number of sweeps (`SENSe<Ch>:SWEEP:COUNT <sweeps>`) and then read any of the data traces acquired.

This feature has no equivalent in manual control where always the last data trace is displayed.

```
// Reset the analyzer
*RST
:SYSTEM:DISPLAY:UPDATE ON

// Create a second and third channel with new diagrams and traces.
:CALCULATE2:PARAMETER:SDEFINE "Trc2","S11"
:CALCULATE2:PARAMETER:SELECT "Trc2"
:DISPLAY:WINDOW2:STATE ON
:DISPLAY:WINDOW2:TRACE1:FEED 'Trc2'

:CALCULATE3:PARAMETER:SDEFINE "Trc3","S11"
:CALCULATE3:PARAMETER:SELECT "Trc3"
:DISPLAY:WINDOW3:STATE ON
:DISPLAY:WINDOW3:TRACE1:FEED 'Trc3'

// Select sweep time for the channels.
:SENSE1:SWEEP:TIME 1 S
:SENSE2:SWEEP:TIME 1 S
:SENSE3:SWEEP:TIME 1 S

// Enable single sweep mode for all channels so that channel-specific
// sweep count settings are used
:INITIATE:CONTINUOUS:ALL OFF

// Select single sweep mode with channel-specific sweep count settings
// Set sweep counts and start measurement in all channels

:SENSE1:SWEEP:COUNT 1
:SENSE2:SWEEP:COUNT 2
:SENSE3:SWEEP:COUNT 3

:INITIATE1:IMMEDIATE; *WAI
:INITIATE2:IMMEDIATE; *WAI
:INITIATE3:IMMEDIATE; *WAI

// Select single sweep mode with global sweep count settings

:SENSE:SWEEP:COUNT:ALL 2

:INITIATE1:IMMEDIATE; *WAI
:INITIATE2:IMMEDIATE; *WAI
:INITIATE3:IMMEDIATE; *WAI
```

### 7.2.4.2 Modeling a Max Hold Function

The following example shows you how to emulate a max hold function.

#### // Reset the analyzer

```
*RST
:DISPlay:WINDow1:TITLe:DATA 'Max Hold Function Emulation'
```

#### // Create a trace with the last extremum as memory trace.

```
:TRACe:COpy 'LastExtr', 'Trc1'

// Display this last extremum trace.
// Because it's a memory trace it must be displayed in the same diagram
// as the mother trace.
:DISPlay:WINDow1:TRACe2:FEED 'LastExtr'
:CALCulate1:MATH:SDEFine 'Max (Data, Mem)'
:CALCulate1:MATH:STATe ON
```

#### // Single sweep mode

```
:INITIATE:CONTINUOUS OFF

// Do a single sweep and update trace with the current extremum.
// This is the last extremum for the next sweep
:INITIATE:IMMEDIATE; *WAI
:TRACe:COpy:MATH 'LastExtr', 'Trc1'

// Loop over these 2 commands
:INITIATE:IMMEDIATE; *WAI
:TRACe:COpy:MATH 'LastExtr', 'Trc1'
:INITIATE:IMMEDIATE; *WAI
:TRACe:COpy:MATH 'LastExtr', 'Trc1'
```

#### // Continuous sweep mode

```
:INITIATE:CONTINUOUS ON
```

### 7.2.4.3 Retrieving the Results of Previous Sweeps

The commands `CALCulate<Ch>:DATA:NSweep...? SDATa,` `<Trace_Hist_Count>` retrieve the results of any sweep within a previously defined single sweep group. This means that, in single sweep mode, you can first measure a specified number of sweeps (`SENSe<Ch>:SWEep:COUNT <sweeps>`) and then read any of the data traces acquired.

This feature has no equivalent in manual control where always the last data trace is displayed.

**// Reset the analyzer**

```
*RST
:SYSTEM:DISPLAY:UPDATE ON
```

**// Create a second channel with a second trace**

```
:CALCULATE2:PARAMETER:SDEFINE "Trc2","S11"
:CALCULATE2:PARAMETER:SELECT "Trc2"
:DISPLAY:WINDOW2:STATE ON
:DISPLAY:WINDOW2:TRACE1:FEED 'Trc2'
```

**// Select active trace for the created channel 2. Adjust the number of sweep points.**

```
:CALCULATE2:PARAMETER:SELECT "Trc2"
:SENSE1:SWEEP:POINTS 3
:SENSE2:SWEEP:POINTS 4
```

**// Set sweep time and sweep count for the channels**

(3 traces per single sweep in channel 1, 4 traces in channel 2)

```
:SENSE1:SWEEP:TIME 1 S
:SENSE2:SWEEP:TIME 1 S
:SENSE1:SWEEP:COUNT 3
:SENSE2:SWEEP:COUNT 4
```

**// 1st Alternative: Reverse reading with command synchronization**

Select single sweep mode and measure a single sweep group for channels no. 1 and 2

```
:INITIATE:CONTInuous:ALL OFF
:INITIATE:IMMEDIATE:ALL; *WAI
```

Read trace data (without history, i.e. the last trace acquired in each channel)

```
:CALCULATE1:DATA? SDATA
:CALCULATE2:DATA? SDATA
```

Read last and previous trace data in channels 1 and 2

```
:CALCULATE1:DATA:NSWEEP? SDATA, 1 // last trace data
:CALCULATE1:DATA:NSWEEP? SDATA, 3 // previous trace data
:CALCULATE2:DATA:NSWEEP? SDATA, 1 // last trace data
:CALCULATE2:DATA:NSWEEP? SDATA, 4 // previous trace data
```

**// 2nd Alternative: Forward reading (no command synchronization necessary)**

Select single sweep mode and measure a single sweep group for channels no. 1

```
:INITIATE1:CONTInuous OFF
:INITIATE1:IMMEDIATE
```

Read the first and the following trace data in channel 1

```

if (CALCULATE1:DATA:NSWEEP:COUNT? > 2)
:CALCULATE1:DATA:NSWEEP:FIRST? SDATA, 1           // first trace data
:CALCULATE1:DATA:NSWEEP:FIRST? SDATA, 3           // third trace data

```

#### 7.2.4.4 Exporting S-Parameters

The calibration defines which S-Parameters are allowed to be exported to a Touchstone file. In the following example a default (TOSM) calibration is created to make all S-Parameters available.

##### // Reset the analyzer

```

*RST
:SYSTEM:DISPLAY:UPDATE ON

:SENSE1:CORRECTION:COLLECT:METHOD:DEFINE 'Test', TOSM, 1, 2, 3, 4
:SENSE1:CORRECTION:COLLECT:SAVE:SELECTED:DEFAULT

```

##### // Initiate a complete sweep

```

:INITIATE1:CONTINUOUS OFF; :INITIATE:IMMEDIATE;*WAI
:MEMORY:STORE:TRACE:PORTS 1, 'ParserTouchstonePorts.s1p', COMPLEX, 2
:MEMORY:STORE:TRACE:PORTS 1, 'ParserTouchstonePorts.s2p', COMPLEX, 3, 2
:MEMORY:STORE:TRACE:PORTS 1, 'ParserTouchstonePorts.s4p', COMPLEX, 1, 4, 3, 2

```

## 7.2.5 Calibration

The following programming examples are related to system error correction and power calibration.

### 7.2.5.1 One and Two-Port Calibration

The following example calibrates one or two analyzer ports.

##### // Reset the analyzer

```

*RST
:SYSTEM:DISPLAY:UPDATE ON

```

##### // Set cal kit as active kit for N50

```

:SENSE:CORRECTION:CKIT:N50:SELECT 'ZV-Z121'

```

##### // Select connectors for the ports

```

:SENSE1:CORRECTION:COLLECT:CONNECTION1 N50MALE
:SENSE1:CORRECTION:COLLECT:CONNECTION2 N50MALE

// Don't save the cal standard measurements with apply cal, i.e. with the commands
// :SENSE1:CORRECTION:COLLECT:SAVE or
// :SENSE1:CORRECTION:COLLECT:SAVE:SELECTED

```



```

// Instead, use the global, channel-independent setting:
:SENSe:CORRection:COLLect:ACQuire:RSaVe:DEFault OFF

// Full one port = OSM

// Select cal procedure
:SENSe:CORRection:COLLect:METhod:DEFine      'Test SFK OSM 1', FOPORT, 1

// Measure Standards
:SENSe:CORRection:COLLect:ACQuire:SELected  OPEN, 1
:SENSe:CORRection:COLLect:ACQuire:SELected  SHORT, 1
:SENSe:CORRection:COLLect:ACQuire:SELected  MATCH, 1

// Apply cal
:SENSe:CORRection:COLLect:SAVe:SELected

// 2 port TOSM

// Select cal procedure
:SENSe:CORRection:COLLect:METhod:DEFine      'Test SFK TOSM 12', TOSM, 1, 2

// Measure Standards
:SENSe:CORRection:COLLect:ACQuire:SELected  THROUGH, 1, 2
:SENSe:CORRection:COLLect:ACQuire:SELected  OPEN, 1
:SENSe:CORRection:COLLect:ACQuire:SELected  SHORT, 1
:SENSe:CORRection:COLLect:ACQuire:SELected  MATCH, 1
:SENSe:CORRection:COLLect:ACQuire:SELected  OPEN, 2
:SENSe:CORRection:COLLect:ACQuire:SELected  SHORT, 2
:SENSe:CORRection:COLLect:ACQuire:SELected  MATCH, 2

// Apply calibration
:SENSe:CORRection:COLLect:SAVe:SELected

// Save / load cal files

// Save calibration in calibration file pool

// the file name in the commands must not contain the path !

:MMEMORY:STORE:CORRection 1, 'OSM1 TOSM12.cal'

// load cal file from calibration file pool
:MMEMORY:LOAD:CORRection 1, 'OSM1 TOSM12.cal'

```

### 7.2.5.2 Saving and Recalling Error Terms

The following examples show you how to perform a system error correction, save the acquired system error correction data to a file and re-load them.

**Performing a Calibration, Saving the Error Terms****// Reset the analyzer**

```
*RST
```

**// Set frequency range**

```
:SENSE1:FREQUENCY1:START 1GHz
:SENSE1:FREQUENCY1:STOP 4GHz
:SENSE1:SWEPT:POINTS 6
```

**// Select calibration type: TOSM at ports 1 and 2**

```
:SENSE1:CORRECTION:COLLECT:METHOD:DEFINE 'Test SFK TOSM 12', TOSM, 1, 2

// Measure Standards
:SENSE1:CORRECTION:COLLECT:ACQUIRE:SELECTED THROUGH, 1, 2
:SENSE1:CORRECTION:COLLECT:ACQUIRE:SELECTED OPEN, 1
:SENSE1:CORRECTION:COLLECT:ACQUIRE:SELECTED SHORT, 1
:SENSE1:CORRECTION:COLLECT:ACQUIRE:SELECTED MATCH, 1
:SENSE1:CORRECTION:COLLECT:ACQUIRE:SELECTED OPEN, 2
:SENSE1:CORRECTION:COLLECT:ACQUIRE:SELECTED SHORT, 2
:SENSE1:CORRECTION:COLLECT:ACQUIRE:SELECTED MATCH, 2
```

**// Apply calibration**

```
SENSE1:CORRECTION:COLLECT:SAVE:SELECTED
```

**// Save error terms**

```
:FORMAT REAL,32
@TRACEFILE:scorr1.dat
:CALCULATE1:DATA? SCORr1
@TRACEFILE:scorr2.dat
:CALCULATE1:DATA? SCORr2
@TRACEFILE:scorr3.dat
:CALCULATE1:DATA? SCORr3
// We are omitting the isolation term, as it is not implemented
// @TRACEFILE:scorr4.dat
// :CALCULATE1:DATA? SCORr4
@TRACEFILE:scorr5.dat
:CALCULATE1:DATA? SCORr5
@TRACEFILE:scorr6.dat
:CALCULATE1:DATA? SCORr6
@TRACEFILE:scorr7.dat
:CALCULATE1:DATA? SCORr7
@TRACEFILE:scorr8.dat
:CALCULATE1:DATA? SCORr8
@TRACEFILE:scorr9.dat
:CALCULATE1:DATA? SCORr9
// We are omitting the isolation term, as it is not implemented
```

```
// @TRACEFILE:scorr10.dat
// :CALCulate1:DATA? SCORr10
@TRACEFILE:scorr11.dat
:CALCulate1:DATA? SCORr11
@TRACEFILE:scorr12.dat
:CALCulate1:DATA? SCORr1
```

## Performing a New Calibration, Recalling the Error Terms

### // Reset the analyzer

```
*RST
```

### // Set frequency range

```
:SENSe1:FREQuency1:StARt 1GHz
:SENSe1:FREQuency1:StOP 4GHz
:SENSe1:SWEep:POINts 6
```

### // Select calibration type: TOSM at ports 1 and 2

```
:SENSe1:CORRection:COLlect:MEthod:DEFine 'XYZ', TOSM, 1, 2
```

### // Generate a set of default correction data, switch on user calibration

```
:SENSe1:CORRection:COLlect:SAVE:SElected:DEFault
SENSE1:CORRECTION:STATE ON
```

```
// In the previous section, the following error terms were saved:
```

```
// SCORR1 Forward Directivity
// SCORR2 Forward Source Match
// SCORR3 Forward Reflection Tracking
// SCORR4 Forward Isolation
// SCORR5 Forward Load Match
// SCORR6 Forward Transmission Tracking
// SCORR7 Reverse Directivity
// SCORR8 Reverse Source Match
// SCORR9 Reverse Reflection Tracking
// SCORR10 Reverse Isolation
// SCORR11 Reverse Load Match
// SCORR12 Reverse Transmission Tracking
```

```
// Equivalences between the first parameter of CALCulate:DATA
// and the first 3 Parameters of SENSe:CORRection:CDAta
```

```
// 'SCORR1' 'DIRECTIVITY', 1, 0 <Port 2> = 0 ignored
// 'SCORR2' 'SRCMATCH', 1, 0 <Port 2> = 0 ignored
// 'SCORR3' 'REFLTRACK', 1, 0 <Port 2> = 0 ignored
// 'SCORR4' 'ISOLATION', 1, 2
// 'SCORR5' 'LOADMATCH', 1, 2
// 'SCORR6' 'TRANSTRACK', 1, 2
// 'SCORR7' 'DIRECTIVITY', 2, 0 <Port 2> = 0 ignored
```

```
// 'SCORR8' 'SRCMATCH', 2, 0 <Port 2> = 0 ignored
// 'SCORR9' 'REFLTRACK', 2, 0 <Port 2> = 0 ignored
// 'SCORR10' 'ISOLATION', 2, 1
// 'SCORR11' 'LOADMATCH', 2, 1
// 'SCORR12' 'TRANSTRACK', 2, 1
```

### // Set format for data transfer

```
:FORMAT REAL,32
```

### // !!! Important !!! Stop sweep when loading error terms

```
:INITiate:CONTinuous OFF
```

### // Recall error terms

```
// CALCulate:DATA is suitable for 2-port terms;
// use SENSE:CORrection:CDATA for more than 2 ports
:CALCulate1:DATA SCORR1,#@scorr1.dat
:CALCulate1:DATA SCORR2,#@scorr2.dat
:CALCulate1:DATA SCORR3,#@scorr3.dat
// We are omitting the isolation term, as it is not implemented on the ZVAB
//:CALCulate1:DATA SCORR4,#@scorr4.dat
:CALCulate1:DATA SCORR5,#@scorr5.dat
:CALCulate1:DATA SCORR6,#@scorr6.dat
:CALCulate1:DATA SCORR7,#@scorr7.dat
:CALCulate1:DATA SCORR8,#@scorr8.dat
:CALCulate1:DATA SCORR9,#@scorr9.dat
// We are omitting the isolation term, as it is not implemented on the ZVAB
//:CALCulate1:DATA SCORR10,#@scorr10.dat
:CALCulate1:DATA SCORR11,#@scorr11.dat
:CALCulate1:DATA SCORR12,#@scorr12.dat

:INITiate:CONTinuous ON
```

## Using a Calibration Data Recorded Previously

You can re-use any set of correction data that you acquired in earlier sessions on your analyzer. In general you have to carry out the following steps:

1. Create a dummy correction data set and store it to a file.
2. Replace the dummy data with your correction data.
3. Re-import the correction data file and apply it to a channel.

See also the program examples for the following commands:

- [SENSe<Ch>:]CORrection:COLlect:SAVE:SElected:DEFault (dummy system error correction)
- SOURce<Ch>:POWer<Pt>:CORrection:DEFault (dummy source power calibration without external power meter)

### 7.2.5.3 Adapter Removal

#### // define calibration method

```
SENSE1:CORRECTION:COLLECT:METHOd:DEFine 'Parser Test SFK', ARTosm, 1, 2
```

#### // Start with Calkit-1 (e.g. 3.5 mm ideal Kit)

```
//adapter side port 1  
SENSE1:CORRECTION:COLLECT:ACQuire:SElected OPEN, 1, ON  
SENSE1:CORRECTION:COLLECT:ACQuire:SElected SHORT, 1, ON  
SENSE1:CORRECTION:COLLECT:ACQuire:SElected MATCh, 1, ON
```

```
//non adapter side port 2  
SENSE1:CORRECTION:COLLECT:ACQuire:SElected OPEN, 2, OFF  
SENSE1:CORRECTION:COLLECT:ACQuire:SElected SHORT, 2, OFF  
SENSE1:CORRECTION:COLLECT:ACQuire:SElected MATCh, 2, OFF
```

#### // continue with Calkit-1 (e.g. N 50 Ohm ideal Kit)

```
//adapter side port 2  
SENSE1:CORRECTION:COLLECT:ACQuire:SElected OPEN, 2, ON  
SENSE1:CORRECTION:COLLECT:ACQuire:SElected SHORT, 2, ON  
SENSE1:CORRECTION:COLLECT:ACQuire:SElected MATCh, 2, ON
```

```
//non adapter side port 1  
SENSE1:CORRECTION:COLLECT:ACQuire:SElected OPEN, 1, OFF  
SENSE1:CORRECTION:COLLECT:ACQuire:SElected SHORT, 1, OFF  
SENSE1:CORRECTION:COLLECT:ACQuire:SElected MATCh, 1, OFF
```

#### // connect adapter between port 1 and 2

```
SENSE1:CORRECTION:COLLECT:ACQuire:SElected THROugh, 1, 2
```

#### // save calibration

```
SENSE1:CORREction:COLLECT:SAVE:SElected
```

## 8 Error Messages and Troubleshooting

### 8.1 Errors during Firmware Operation

An error generally causes the analyzer to display a tooltip across the lower part of the screen. The tooltip provides a textual description of the error, e.g.:

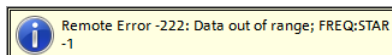

The errors can be divided into four categories:

- Remote errors (SCPI errors) may occur during the execution of a remote control program. They include an error code, followed by the short description of the error. Remote errors are specified and described in the SCPI standard; they are cleared upon \*CLS.
- Software errors (setting errors) can occur e.g. if numeric entries in an analyzer dialog are incompatible with each other or with the current analyzer state. These errors are generally self-explanatory and easy to correct.
- Hardware errors indicate an incorrect hardware state. Some of the hardware errors cause the instrument to be switched off in order to avoid damage. Hardware errors with possible causes and remedies are listed in the following sections.
- Exceptions indicate anomalous or exceptional events that were not properly handled by the R&S ZNC/ZND firmware.



#### Troubleshooting SCPI errors

A misspelled command header causes SCPI error -113, "Undefined header;..."; a misspelled parameter causes SCPI error -141, "Invalid character data;...". The GPIB explorer provides a list of all supported commands and their character data parameters; see [Chapter 5.1.2, "GPIB Explorer"](#), on page 360.

#### Hardware error categories

Hardware errors can be detected at various stages of the start-up or measurement procedure.

- Configuration errors occur on start-up of the analyzer, e.g. if a hardware module or configuration file cannot be detected. Configuration errors cause an entry in the error log ("SYSTEM > SETUP > Setup > Info... > Error Log").
- Asynchronous errors can occur any time while the analyzer is operating. The analyzer is checked periodically for asynchronous errors.
- Measurement errors are due to inadmissible hardware settings and states during the measurement process.

### 8.1.1 Asynchronous Errors

Asynchronous errors can occur any time while the analyzer is operating. The analyzer is checked periodically for asynchronous errors. Many of these errors also cause an entry in the status reporting system.

| Error                                  | Description                                                                                                                                                                                                                    | Remedy                                                                              | Bit no.*) |
|----------------------------------------|--------------------------------------------------------------------------------------------------------------------------------------------------------------------------------------------------------------------------------|-------------------------------------------------------------------------------------|-----------|
| Instrument temperature is too high     | The analyzer detects that the instrument temperature is too high. After three warnings, the analyzer is shut down.                                                                                                             | Reduce ambient temperature, keep ventilation holes of the casing unobstructed.      | 7         |
| Receiver overload protection tripped   | The analyzer detects an excessive input level at one of the ports. If this condition persists, all internal and external generators are switched off (Channel – Power Bandwidth Average – RF Off).                             | Reduce RF input level at the port. Check amplifiers in the external test setup.     | 3         |
| Reference frequency lock failure       | With external reference signal (System – External Reference active) or option ZVAB-B4 (oven quartz), the reference oscillator is phase locked to a 10 MHz signal. The message appears when this phase locked loop (PLL) fails. | For external reference: check frequency and level of the supplied reference signal. | 1         |
| Converter clock frequency lock failure | The clock generator for the AD converter clock is phase locked to the reference oscillator. The message appears when this PLL fails.                                                                                           | –                                                                                   | –         |
| Oven cold                              | With option R&S ZVAB-B4, oven quartz: The oven temperature is too low.                                                                                                                                                         | Wait until the oven has been heated up                                              | 8         |

\*) The following bits in the `STATus:QUEStionable:INTEgrity:HARDware` register are set when the error occurs.

### 8.1.2 Errors during Measurement

The following errors are due to inadmissible hardware settings and states during the measurement process. Some of the errors also cause an entry in the status reporting system.

| Error                                           | Description                                                                                                                                                                       | Remedy                                                                                                                                                                              | Bit no.*) |
|-------------------------------------------------|-----------------------------------------------------------------------------------------------------------------------------------------------------------------------------------|-------------------------------------------------------------------------------------------------------------------------------------------------------------------------------------|-----------|
| Unstable level control at port <i>              | The analyzer detects an excessive source level at one of the ports. The signal is turned off and the sweep halted.                                                                | Check signal path for the wave ai, especially check external components. Then press "Channel > Sweep > Sweep Control > Restart Sweep".                                              | 9         |
| Problem concerning external power meter Pmet<i> | An external power meter has been configured, however, it cannot be controlled or provides error messages. If several power meters cause problems, the lowest number is indicated. | Check whether the power meter is properly connected and switched on. Check the GPIB address; exclude address conflicts when using several external power meters or other equipment. | 11        |
| Time grid too close                             | The sweep points for a time sweep are too close, the analyzer cannot process the measurement data until the next sweep point starts.                                              | Increase stop time, reduce no. of points, increase IF bandwidth. If possible reduce number of partial measurements, e.g. by restricting the number of ports measured.               | 12        |

| Error                            | Description                                                                                | Remedy                                                         | Bit no.*) |
|----------------------------------|--------------------------------------------------------------------------------------------|----------------------------------------------------------------|-----------|
| Overload at DC MEAS <range>      | The input voltage at one of the DC input connectors on the rear panel is too high.         | Reduce input voltage.                                          | 13        |
| Port <i> output power unlevelled | The level control is unsettled or unstable, possibly due to an external disturbing signal. | Change generator level at the port; check external components. | 2         |

\*) The following bits in the `STATUS:QUESTIONABLE:INTEGRITY:HARDWARE` register are set when the error occurs.

### 8.1.3 Obtaining Technical Support

The instrument generates error messages which in most cases will be sufficient for you to detect the cause of an error and find a remedy. Error message types are described in [Chapter 8, "Error Messages and Troubleshooting"](#), on page 798.

In addition, our customer support centers are there to assist you in solving any problems that you may encounter with your network analyzer. We will find solutions more quickly and efficiently if you provide us with the information listed below. Simply open the relevant dialogs in the "Info" dialog, select "Save...", and send us the file.

- **Setup Info:** The instrument setup information ("Info > Setup Info") contains your instrument settings. You can also send us the VNA recall set file (\*.znx) that you generate after the fault occurs ("File > Recall Sets > Save...").
- **Option Info:** The option info ("Info > Option Info") informs us about the status of all software and hardware options of your analyzer.
- **Hardware Info:** The hardware info ("Info > Hardware Info") shows us the installed options and hardware assemblies.
- **Error Log:** The error log ("Info > Error Log") contains a chronological record of errors.
- **Exception Dumps:** In case of an exception the R&S ZNC/ZND automatically generates a dump file for debugging purposes.  
The level of detail of the dumps can be set from the [Advanced](#) tab of the "System Config" dialog.  
The latest 5 exception dumps can be retrieved using the "Save Report" function of the "Info" dialog.
- **Save Report:** The system report command ("Info > Save Report") collects the setup, option, and hardware information as well as the error log and the current selftest results and writes everything to a \*.zip file. The \*.zip file also contains the current eeprom data and a screenshot of the VNA display. It is written to the report directory `C:\Users\Public\Documents\Vna\Report`. The file name contains the current date and time, e.g. `report_20110125_1658.zip`. "Save Report" provides the most comprehensive information, comprising all other "Info" files.

See also ["Save... / Print... / Save Report"](#) on page 342.



## 8.2 Errors during Firmware Installation/Update

During firmware installation or update, if the installer encounters an error, the update is cancelled and the analyzer firmware is rolled back to its previous state.

Currently there is only one exception to this rule, which was implemented to gracefully recover from a failed FPGA update:

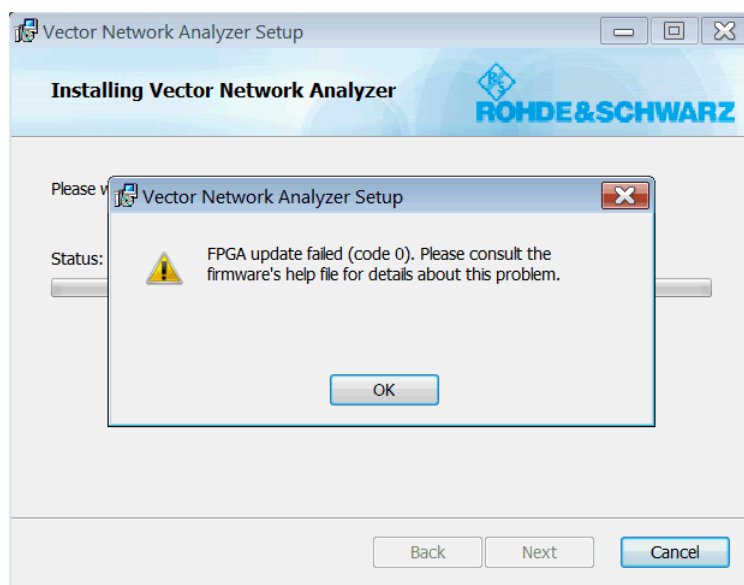

**Figure 8-1: FPGA update failure**

In this case the installation proceeds but requires additional steps to be taken in order to perform the failed FPGA update manually.



No matter if the manual FPGA update described below is successful or not, write down the error code and contact our support.

1. Reboot the analyzer.
2. Exit the firmware.
3. Run the flash utility located at `C:\Program Files\Rohde-Schwarz\Vector Network Analyzer\Bin\flash.exe` and wait until the process has completed.

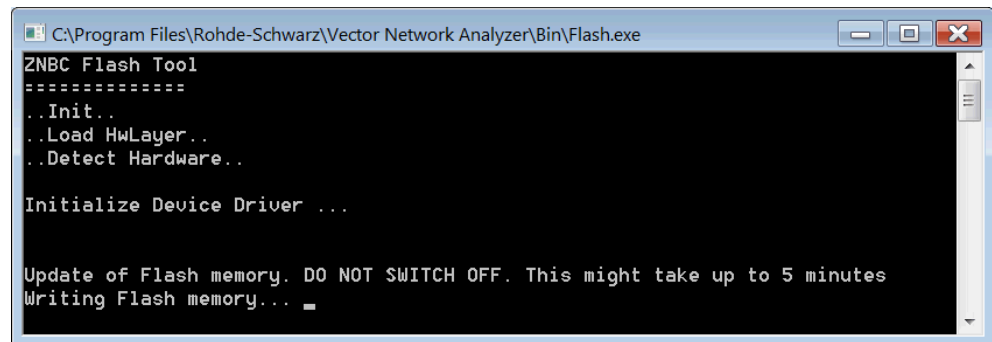

```
C:\Program Files\Rohde-Schwarz\Vector Network Analyzer\Bin\Flash.exe
ZNBC Flash Tool
=====
..Init..
..Load HwLayer..
..Detect Hardware..

Initialize Device Driver ...

Update of Flash memory. DO NOT SWITCH OFF. This might take up to 5 minutes
Writing Flash memory... █
```

*Figure 8-2: FPGA flash tool*

4. Turn off the analyzer (a reboot is not sufficient).

If successful, this procedure should bring the analyzer back to working condition.

## 9 Annexes

The following sections cover mostly hardware and service-related topics.

### 9.1 Interfaces and Connectors

This chapter provides a detailed description of the rear panel connectors of the R&S ZNC/ZND. For an overview of the rear panel connectors refer to section "Rear Panel Tour" in the Help or in the Getting Started guide. The front panel is described in section "Front Panel Tour".

#### 9.1.1 Rear Panel Connectors

The rear panel of the R&S ZNC/ZND provides various connectors for external devices and control signals.

##### 9.1.1.1 USER PORT

25-pole D-Sub connector used as an input and output for low-voltage (3.3 V) TTL control signals. Some of the USER PORT lines can be controlled via GPIB bus (see [CON-Trol Commands](#) and [OUTPut Commands](#)).



| Pin No. | Name              | Input (I) or Output (O) | Function                                                                                                                      |
|---------|-------------------|-------------------------|-------------------------------------------------------------------------------------------------------------------------------|
| 1       | GNDD              | -                       | Digital ground                                                                                                                |
| 2       | EXT TRG           | I                       | External trigger signal, 5 V tolerant *)                                                                                      |
| 3       | GNDD              | -                       | Digital ground                                                                                                                |
| 4       | BUSY              | O                       | Measurement running                                                                                                           |
| 5       | GNDD              | -                       | Digital ground                                                                                                                |
| 6       | READY FOR TRIGGER | O                       | Measurement terminated, ready for trigger (not available for pulsed measurements)                                             |
| 7       | GNDD              | -                       | Digital ground                                                                                                                |
| 8       | CHANNEL BIT 0     | O                       | Channel-specific bit 0;<br>see <a href="#">CON-Trol:AUXiliary:C[:DATA]</a> and <a href="#">OUTPut&lt;Ch&gt;:UPort[:VALue]</a> |
| 9       | CHANNEL BIT 1     | O                       | Channel-specific bit 1                                                                                                        |
| 10      | CHANNEL BIT 2     | O                       | Channel-specific bit 2                                                                                                        |

| Pin No. | Name          | Input (I) or Output (O) | Function                                                                                         |
|---------|---------------|-------------------------|--------------------------------------------------------------------------------------------------|
| 11      | CHANNEL BIT 3 | O                       | Channel-specific bit 3                                                                           |
| 12      | GNDD          | -                       | Digital ground                                                                                   |
| 13      | PASS 1        | O                       | Pass/fail result of limit check; TTL Out Pass 1 (see <a href="#">TTL 1 / 2 Pass</a> )            |
| 14      | PASS 2        | O                       | Pass/fail result of limit check TTL Out Pass 2                                                   |
| 15      | GNDD          | -                       | Digital ground                                                                                   |
| 16      | DRIVE PORT 1  | O                       | Test port 1 is source port (drive port); see <a href="#">OUTPut&lt;Ch&gt; : UPORT [ : VALue]</a> |
| 17      | DRIVE PORT 2  | O                       | Test port 2 is source port (drive port)                                                          |
| 18      | DRIVE PORT 3  | O                       | Test port 3 is source port (drive port)                                                          |
| 19      | DRIVE PORT 4  | O                       | Test port 4 is source port (drive port)                                                          |
| 20      | GNDD          | -                       | Digital ground                                                                                   |
| 21      | EXT GEN TRG   | O                       | Control signal for external generator                                                            |
| 22      | EXT GEN BLANK | I                       | Handshake signal from external generator                                                         |
| 23      | GNDD          | -                       | Digital ground                                                                                   |
| 24      | FOOT SWITCH 1 | I                       | Control input A, 5 V tolerant                                                                    |
| 25      | EXT TRG 2     | I                       | External trigger 2 signal, 5 V tolerant                                                          |

\*) Feeding in the external trigger signal via the BNC connector EXT TRIG IN is equivalent. The minimum pulse width of the trigger signals is 1  $\mu$ s.



### EMI Suppression

Use only double shielded cables or disconnect the input pins of the USER PORT connector in order to avoid spurious input signals which may cause undesirable events.

#### 9.1.1.2 EXT TRIG OUT / IN



Two BNC female connectors for external trigger input or output signals; see "[Free Run / External / Manual / Multiple Triggers](#)" on page 305.

**Input signal:** The external trigger input signal must be a 3.3 V or 5 V TTL signal with a minimum pulse width of 1  $\mu$ s. The trigger input has a high input impedance (> 10 k $\Omega$ ).

**Output signal:** The R&S ZNC/ZND trigger output provides a configurable 5 V TTL trigger signal. The output impedance is approximately 50 Ohm.



### Trigger cables

Be aware that long trigger cables may cause signal reflections!

## 9.1.2 LAN Interface

To be integrated in a LAN, the instrument is equipped with a LAN interface, consisting of a RJ-45 connector, a network interface card and protocols. The network interface card supports IEEE 802.3 for a 10 Mbps Ethernet and IEEE 802.3u for a 100 Mbps Ethernet.

Instrument access is possible via the VXI-11 protocol. It is usually achieved from high level programming platforms by using the Virtual Instrument Software Architecture (VISA) library as an intermediate abstraction layer. VISA encapsulates the low level function calls and thus makes the transport interface transparent for the user. See also [Chapter 5.1, "Introduction to Remote Control"](#), on page 359.

### 9.1.2.1 VXI-11 Interface Messages

The following VXI-11 interface messages (also termed low-level control messages) are also supported by the GPIB Explorer.

| Command | Meaning               | Effect on the instrument                                                                                                                                          |
|---------|-----------------------|-------------------------------------------------------------------------------------------------------------------------------------------------------------------|
| @DCL    | Device Clear          | Aborts the processing of the commands just received and sets the command processing software to a defined initial state. Does not change the instrument settings. |
| @GET    | Group Execute Trigger | Triggers the active measurement sequence (e.g. a sweep). The effect of the command is the same as with that of a pulse at the external trigger signal input.      |
| @LOC    | Go to Local           | Transition to the "local" state (manual control).                                                                                                                 |
| @REM    | Go to Remote          | Transition to the "remote" state (remote control).                                                                                                                |

## 9.1.3 GPIB Interface

The R&S ZNC/ZND can be equipped with a GPIB (IEC/IEEE) bus interface (option R&S ZNC/ZND-B10). The interface connector labeled "GPIB" is located on the rear panel of the instrument. The GPIB bus interface is intended for remote control of the R&S ZNC/ZND from a controller.



To be compliant with EMC regulations open IEEE cables should be avoided. IEEE cables must be connected on both sides.

### Characteristics of the interface

- 8-bit parallel data transfer
- Bidirectional data transfer
- Three-line handshake
- High data transfer rate of max. 1 MByte/s
- Up to 15 devices can be connected

- Maximum length of the connecting cables 15 m. The length of a single connecting cable should not exceed 2 m, if many devices are used, it should not exceed 1 m.
- Wired OR if several instruments are connected in parallel

### Pin assignment

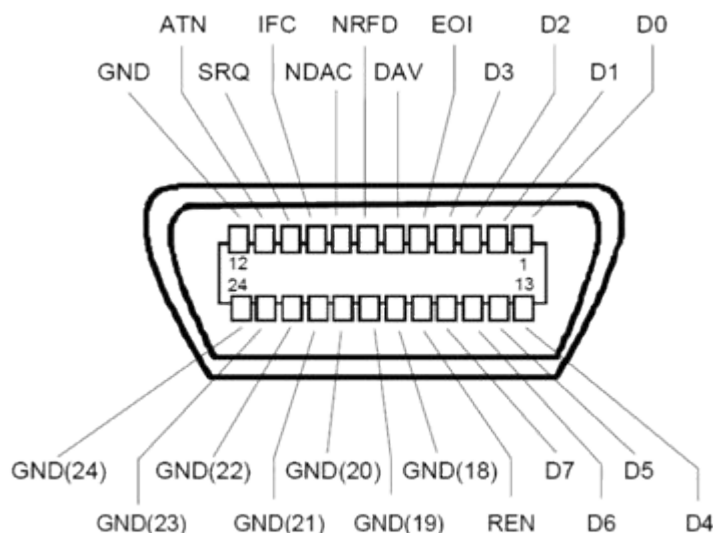

### Bus lines

- Data bus with 8 lines D0 to D7:  
The transmission is bit-parallel and byte-serial in the ASCII/ISO code. D0 is the least significant bit, D7 the most significant bit.
- Control bus with five lines:  
**IFC** (Interface Clear): active LOW resets the interfaces of the instruments connected to the default setting.  
**ATN** (Attention): active LOW signals the transmission of interface messages, inactive HIGH signals the transmission of device messages.  
**SRQ** (Service Request): active LOW enables the connected device to send a service request to the controller.  
**REN** (Remote Enable): active LOW permits switchover to remote control.  
**EOI** (End or Identify): has two functions in connection with ATN:
  - ATN=HIGH active LOW marks the end of data transmission.
  - ATN=LOW active LOW triggers a parallel poll.
- Handshake bus with three lines:  
**DAV** (Data Valid): active LOW signals a valid data byte on the data bus.  
**NRFD** (Not Ready For Data): active LOW signals that one of the connected devices is not ready for data transfer.  
**NDAC** (Not Data Accepted): active LOW signals that the instrument connected is accepting the data on the data bus.

The R&S ZNC/ZND provides several functions to communicate via GPIB bus. They are described in the following sections.

### 9.1.3.1 Interface Functions

Instruments which can be controlled via GPIB bus can be equipped with different interface functions. The interface function for the R&S ZNC/ZND are listed in the following table.

| Control character | Interface function                                                                       |
|-------------------|------------------------------------------------------------------------------------------|
| SH1               | Handshake source function (source handshake), full capability                            |
| AH1               | Handshake sink function (acceptor handshake), full capability                            |
| L4                | Listener function, full capability, de-addressed by MTA.                                 |
| T6                | Talker function, full capability, ability to respond to serial poll, de-addressed by MLA |
| SR1               | Service request function (Service Request), full capability                              |
| PP1               | Parallel poll function, full capability                                                  |
| RL1               | Remote/Local switch over function, full capability                                       |
| DC1               | Reset function (Device Clear), full capability                                           |
| DT1               | Trigger function (Device Trigger), full capability                                       |

### 9.1.3.2 Interface Messages

Interface messages are transmitted to the instrument on the data lines, with the attention line being active (LOW). They serve to communicate between controller and instrument.

#### Universal commands

Universal commands are encoded in the range 10 through 1F hex. They are effective for all instruments connected to the bus without previous addressing.

| Command                     | QuickBASIC command              | Effect on the instrument                                                                                                                                          |
|-----------------------------|---------------------------------|-------------------------------------------------------------------------------------------------------------------------------------------------------------------|
| DCL<br>(Device Clear)       | IBCMD (controller %, CHR\$(20)) | Aborts the processing of the commands just received and sets the command processing software to a defined initial state. Does not change the instrument settings. |
| IFC<br>(Interface Clear)    | IBSIC (controller%)             | Resets the interfaces to the default setting.                                                                                                                     |
| LLO<br>(Local Lockout)      | IBCMD (controller %, CHR\$(17)) | The LOC/IEC ADDR key is disabled.                                                                                                                                 |
| SPE<br>(Serial Poll Enable) | IBCMD (controller %, CHR\$(24)) | Ready for serial poll                                                                                                                                             |

| Command                            | QuickBASIC command              | Effect on the instrument       |
|------------------------------------|---------------------------------|--------------------------------|
| SPD<br>(Serial Poll Disable)       | IBCMD (controller %, CHR\$(25)) | End of serial poll             |
| PPU<br>(Parallel Poll Unconfigure) | IBCMD (controller %, CHR\$(21)) | End of the parallel-poll state |

### Addressed commands

Addressed commands are encoded in the range 00 through 0F hex. They are only effective for instruments addressed as listeners.

| Command                          | QuickBASIC command     | Effect on the instrument                                                                                                                                         |
|----------------------------------|------------------------|------------------------------------------------------------------------------------------------------------------------------------------------------------------|
| GET<br>(Group Execute Trigger)   | IBTRG (device%)        | Triggers a previously active device function (e.g. a sweep). The effect of the command is the same as with that of a pulse at the external trigger signal input. |
| GTL<br>(Go to Local)             | IBLOC (device%)        | Transition to the "Local" state (manual control)                                                                                                                 |
| PPC<br>(Parallel Poll Configure) | IBPPC (device%, data%) | Configures the instrument for parallel poll. Additionally, the QuickBASIC command executes PPE/PPD.                                                              |
| SDC<br>(Selected Device Clear)   | IBCLR (device%)        | Aborts the processing of the commands just received and sets the command processing software to a defined initial state. Does not change the instrument setting. |

#### 9.1.3.3 Instrument Messages

Instrument messages (commands) are transferred on the data lines of the GPIB bus while the ATN line is not active. ASCII code is used.

Structure and syntax of the instrument messages are described in [Chapter 6, "Command Reference"](#), on page 398. The chapter also provides a detailed description of all messages implemented by the analyzer.

#### 9.1.4 Universal Interface

A network analyzer which is equipped with option R&S ZN-B14, Handler I/O (Universal Interface), can interact with an external part handler. The digital control signals on the interface connector indicate the possible start and the end of a measurement, as well as a global limit check result. Typically, the handler will insert the device to be tested into a test fixture, provide a trigger pulse to initiate the measurement, remove and replace the device after the measurement is complete and sort it into pass/fail bins. A sample flow diagram for this process is shown below.



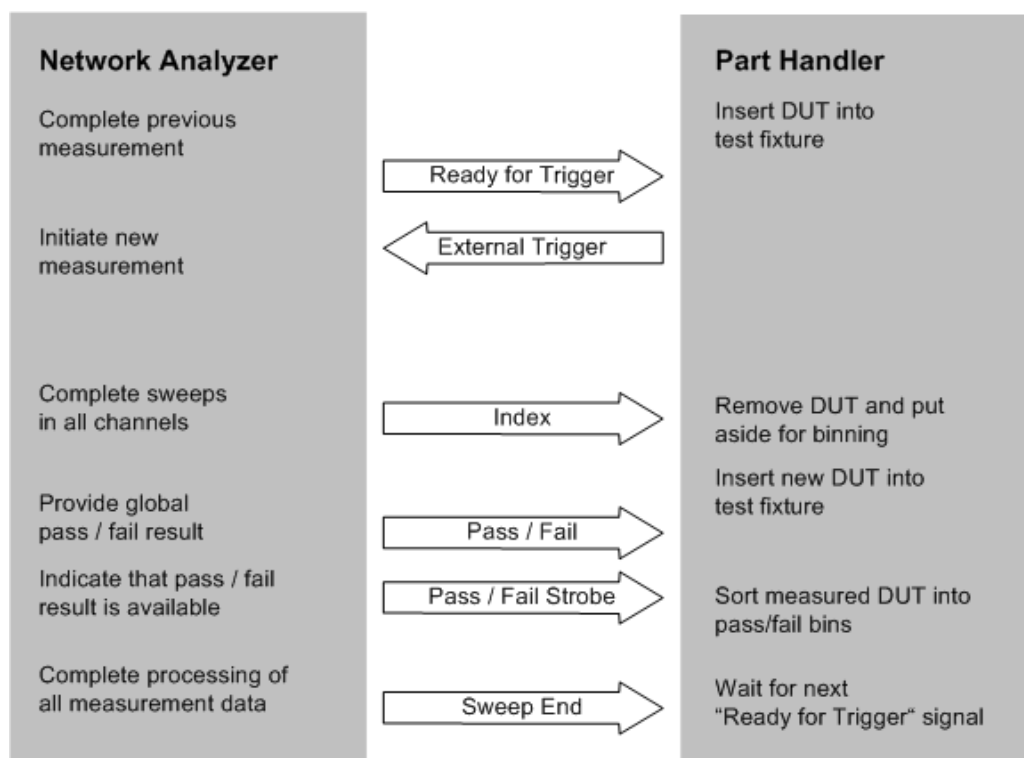

Figure 9-1: Possible stages of an automated test

### Preparation of the network analyzer and the part handler

The network analyzer configuration depends on the measurement to be made. Starting from the preset state, you will usually have to adjust the following settings:

1. Enable external trigger: "CHANNEL > TRIGGER > Trigger > External"
2. (Optional:) Select single sweep mode: "CHANNEL > SWEEP > Sweep Control > Single"
3. Define limit lines and enable the limit check: "TRACE > LINES > Limit Test > ..."

The Universal Interface connector must be connected to the part handler using an appropriate cable. If required, configure the data ports to ensure that the network analyzer and the part handler are compatible.

#### 9.1.4.1 Control Signals

Most of the signals in the figure below are controlled by the measurement. It is possible though to query the transitions of the "Input 1" signal, to configure the "Output 1", "Output 2", "Sweep End", and "Pass/Fail" signals and to route the "Index" and "Ready for Trigger" signals using SCPI commands.

- `CONTROL:HANDLER:INPut?` queries the high to low transitions of the "Input 1" signal.

- The `CONTROL:HANDler:OUTPut<Pt>...` commands set the output signals to a definite state and specify whether this state will change to "Low" when the Input 1 signal goes to "Low". This mechanism provides either static output signals or output signals which are controlled by Input 1.
- The "Index" and "Ready for Trigger" signals can be routed to pins 20 and 21 of the Universal Interface connector, where they replace the PORT B6 and PORT B7 input/output signals. See [Chapter 9.1.4.2, "Data Ports"](#), on page 810.
- The `CONTROL:HANDler:PASSfail...` commands configure the "Pass/Fail" signal and query the global pass/fail status of the last measurement.

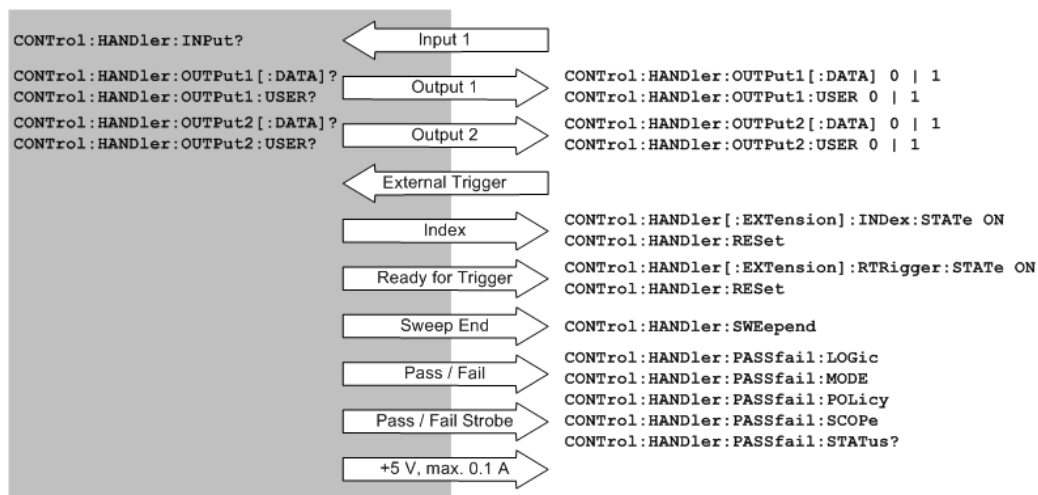

Figure 9-2: Control signals and power supply

SCPI commands: See [Chapter 6.3.4, "CONTROL Commands"](#), on page 499

#### 9.1.4.2 Data Ports

In addition to the control signals, the Universal Interface provides four bi-directional data ports A, B, C, D. The data ports must be configured explicitly using SCPI commands; they are not controlled by the measurement.

- With an output data port you can configure the part handler or other devices used in testing from the network analyzer.
- With an input data port you can configure the network analyzer using external signals and an appropriate control program.

Device configurations via data port signals are usually performed in a preliminary stage, prior to the actual measurement sequence. If the "Index" and "Ready for Trigger" signals are enabled at this stage (see [Chapter 9.1.4.1, "Control Signals"](#), on page 809), they replace the PORT B6 and PORT B7 signals. Port B can still be used as a 6-bit parallel input/output port.

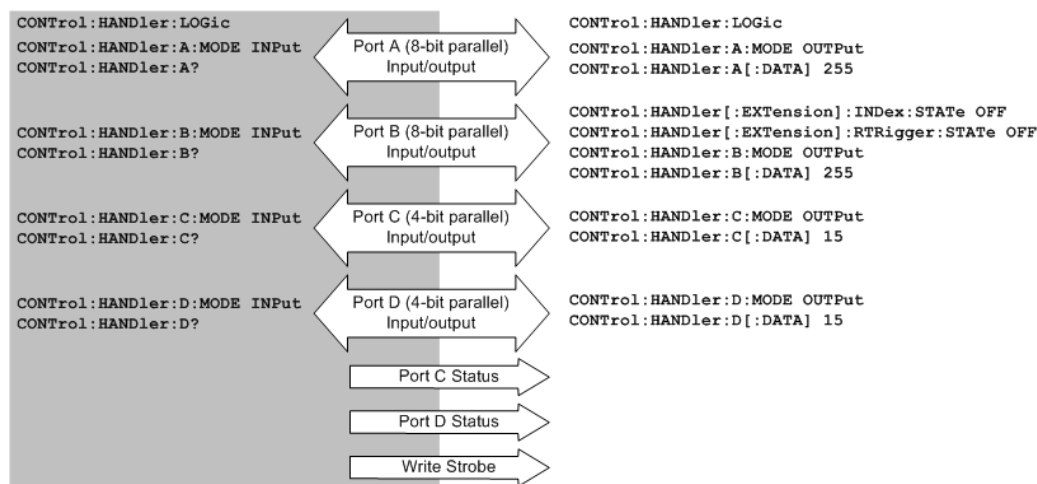

Figure 9-3: Data ports and related signals

### Combined ports (ports E, F, G, H)

A combination of ports A / B and ports C / D provides two additional 16-bit and 8-bit-wide bidirectional ports. The combined ports are termed ports E and F, respectively. A combination of ports A / B / C and ports A / B / C / D provides two 20-bit and 24-bit-wide bidirectional ports. These combined ports are termed ports G and H.

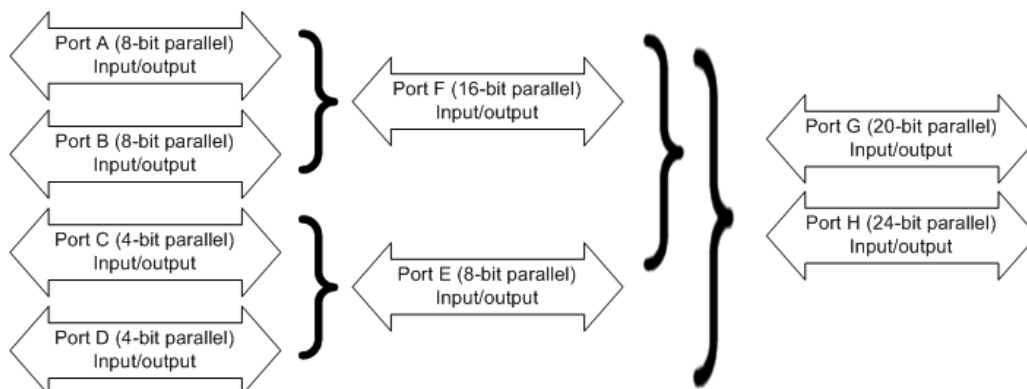

Figure 9-4: Definition of ports E, F, G, H

The properties of the combined ports are as follows:

- The signal direction (input or output) is according to the configuration of ports A, B, C, and D. E.g. to write data to port G (H), ports A, B, and C (A, B, C, and D) must be configured as output ports.
- Data can be read and written using the `CONTROL:HANDLER:E|F|G|H[:DATA]` commands.
- The bit order is D3 ... D0 C3 ... C0 (port E), B7 ... B0 A7 ... A0 (port F), C3 ... C0 B7 ... B0 A7 ... A0 (port G), and D3 ... D0 C3 ... C0 B7 ... B0 A7 ... A0 (port H).

SCPI commands: See [Chapter 6.3.4, "CONTROL Commands"](#), on page 499

### 9.1.4.3 Universal Interface Connector

Option R&S ZN-B14, Handler I/O (Universal Interface), must be installed by an R&S service representative. The option includes a Centronics 36 input/output connector which is placed in the right-hand part of the network analyzer's rear panel. The pin assignment of the connector is shown below. A slash (/) at the beginning of the signal name indicates that it is an active low (negative logic) signal.

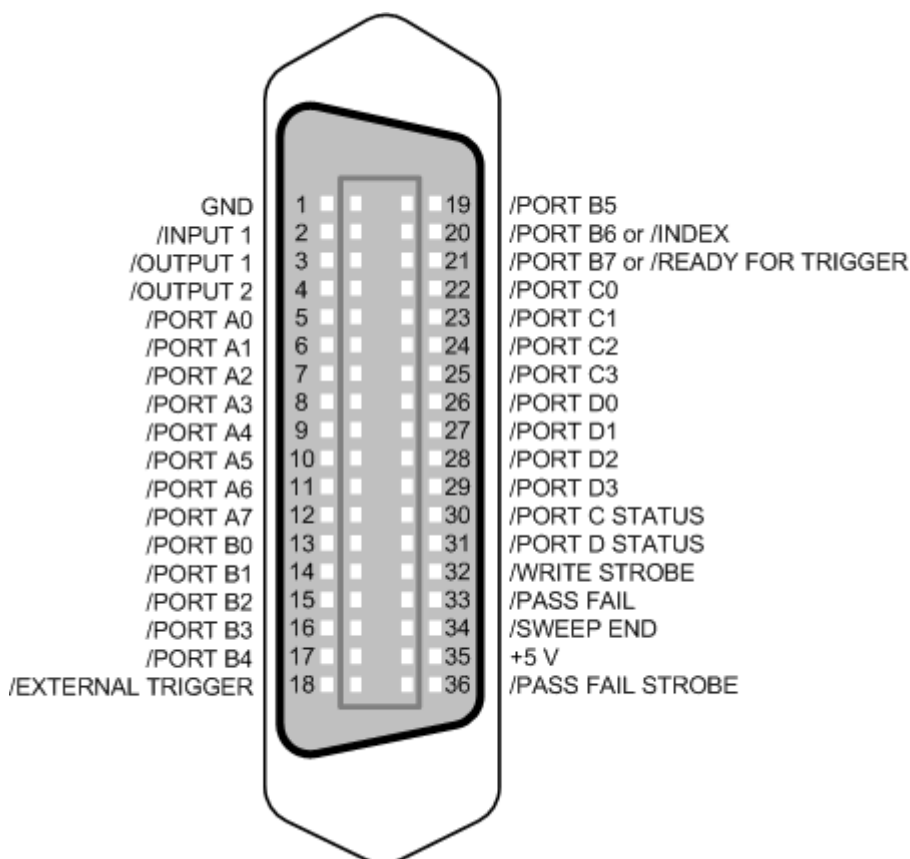

Figure 9-5: Pin assignment of the Universal Interface connector

The input and output signals at the connector are described below.

| Pin No. | Signal    | Input (I) or Output (O) | Description                                                                                                        |
|---------|-----------|-------------------------|--------------------------------------------------------------------------------------------------------------------|
| 1       | GND       | –                       | Ground                                                                                                             |
| 2       | /INPUT 1  | I                       | When a negative pulse is fed to this port, the /OUTPUT 1 and /OUTPUT 2 signals (pins no. 3 and 4) change to "Low". |
| 3       | /OUTPUT 1 | O                       | Changes to "Low" when the /INPUT 1 (pin no. 2) receives a negative pulse.                                          |
| 4       | /OUTPUT 2 | O                       | Changes to "Low" when the /INPUT 1 (pin no. 2) receives a negative pulse.                                          |
| 5       | /PORT A0  | I or O                  | Port A, bit no. 0 (8-bit parallel input or output port)                                                            |
| 6       | /PORT A1  | I or O                  | Port A, bit no. 1                                                                                                  |

| Pin No. | Signal                         | Input (I) or Output (O) | Description                                                                                                                                                                                                        |
|---------|--------------------------------|-------------------------|--------------------------------------------------------------------------------------------------------------------------------------------------------------------------------------------------------------------|
| 7       | /PORT A2                       | I or O                  | Port A, bit no. 2                                                                                                                                                                                                  |
| 8       | /PORT A3                       | I or O                  | Port A, bit no. 3                                                                                                                                                                                                  |
| 9       | /PORT A4                       | I or O                  | Port A, bit no. 4                                                                                                                                                                                                  |
| 10      | /PORT A5                       | I or O                  | Port A, bit no. 5                                                                                                                                                                                                  |
| 11      | /PORT A6                       | I or O                  | Port A, bit no. 6                                                                                                                                                                                                  |
| 12      | /PORT A7                       | I or O                  | Port A, bit no. 7                                                                                                                                                                                                  |
| 13      | /PORT B0                       | I or O                  | Port B, bit no. 0 (8-bit parallel input or output port)                                                                                                                                                            |
| 14      | /PORT B1                       | I or O                  | Port B, bit no. 1                                                                                                                                                                                                  |
| 15      | /PORT B2                       | I or O                  | Port B, bit no. 2                                                                                                                                                                                                  |
| 16      | /PORT B3                       | I or O                  | Port B, bit no. 3                                                                                                                                                                                                  |
| 17      | /PORT B4                       | I or O                  | Port B, bit no. 4                                                                                                                                                                                                  |
| 18      | /EXTERNAL TRIGGER              | I                       | External trigger signal                                                                                                                                                                                            |
| 19      | /PORT B5                       | I or O                  | Port B, bit no. 5                                                                                                                                                                                                  |
| 20      | /PORT B6 or /INDEX             | I or O<br>O             | Port B, bit no. 6<br>The /INDEX signal changes to "Low" when a measurement is complete (all sweeps in all channels have been performed; the DUT can be removed, but the measurement results may not be valid yet). |
| 21      | /PORT B7 or /READY FOR TRIGGER | I or O<br>O             | Port B, bit no. 7<br>The /READY FOR TRIGGER signal changes to "Low" when the analyzer is ready to receive a trigger for a new measurement.                                                                         |
| 22      | /PORT C0                       | I or O                  | Port C, bit no. 0 (4-bit parallel input or output port)                                                                                                                                                            |
| 23      | /PORT C1                       | I or O                  | Port C, bit no. 1                                                                                                                                                                                                  |
| 24      | /PORT C2                       | I or O                  | Port C, bit no. 2                                                                                                                                                                                                  |
| 25      | /PORT C3                       | I or O                  | Port C, bit no. 3                                                                                                                                                                                                  |
| 26      | /PORT D0                       | I or O                  | Port D, bit no. 0 (4-bit parallel input or output port)                                                                                                                                                            |
| 27      | /PORT D1                       | I or O                  | Port D, bit no. 1                                                                                                                                                                                                  |
| 28      | /PORT D2                       | I or O                  | Port D, bit no. 2                                                                                                                                                                                                  |
| 29      | /PORT D3                       | I or O                  | Port D, bit no. 3                                                                                                                                                                                                  |
| 30      | /PORT C STATUS                 | O                       | Indicates the status of port C:<br><ul style="list-style-type: none"> <li>• Low: port C is an input port</li> <li>• High: port C is an output port</li> </ul>                                                      |
| 31      | /PORT D STATUS                 | O                       | Indicates the status of port D:<br><ul style="list-style-type: none"> <li>• Low: port D is an input port</li> <li>• High: port D is an output port</li> </ul>                                                      |
| 32      | /WRITE STROBE                  | O                       | Changes to "Low" when valid data is present at any of the output ports (i.e. when the output level at any port changes).                                                                                           |

| Pin No. | Signal            | Input (I) or Output (O) | Description                                                                                                                                                                                                                                                                                      |
|---------|-------------------|-------------------------|--------------------------------------------------------------------------------------------------------------------------------------------------------------------------------------------------------------------------------------------------------------------------------------------------|
| 33      | /PASS FAIL        | O                       | Indicates the status of the global limit check for the last measurement: <ul style="list-style-type: none"> <li>• Low: global limit check failed</li> <li>• High: global limit check passed</li> </ul> Other configurations are possible; see <code>CONTRol:HANDler:PASSfail...</code> commands. |
| 34      | /SWEEP END        | O                       | Indicates the end of the measurement. Changes to "Low" after all sweeps in all channels have been completed and the measurement data has been processed. Alternative configurations: see <code>CONTRol:HANDler:SWEEPend</code> .                                                                 |
| 35      | +5 V DC           | O                       | DC power supply for external devices; +5 V ± 250 mV, max. 0.1 A                                                                                                                                                                                                                                  |
| 36      | /PASS FAIL STROBE | O                       | Changes to "Low" when limit check results are present on /PASS FAIL (pin no. 33).                                                                                                                                                                                                                |

All digital input signals must be TTL compatible with an allowed input voltage range between -0.5 V and +5.5 V. The circuit diagram of the input path is shown below.

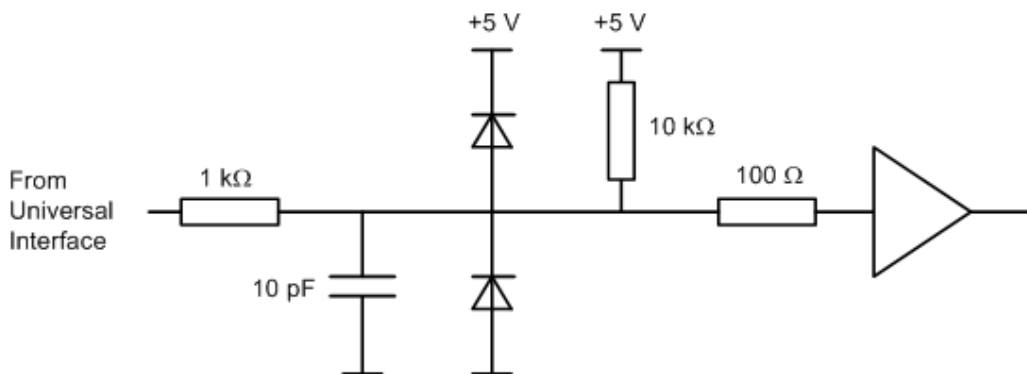

Figure 9-6: Circuit diagram of the input path

Digital output signals are low-voltage TTL compatible with output voltages between 0 V and +3.3 V. The circuit diagram of the output path is shown below.

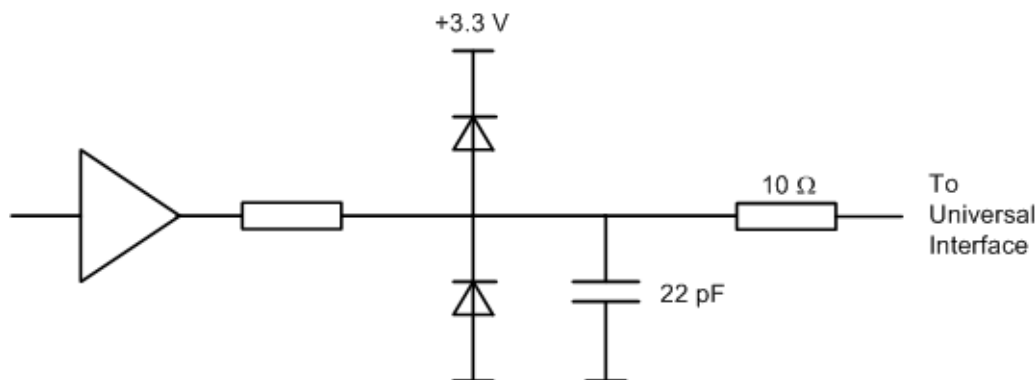

Figure 9-7: Circuit diagram of the output path

The default configuration of the signals is listed below. Notice that \*RST or "Preset" do not change the configuration of the Universal Interface. Use `CONTROL:HANDler:RESet` to restore default values.

| Signal                         | *RST Configuration                        |
|--------------------------------|-------------------------------------------|
| Port A, Port B                 | Output ports, all bits "High" (decimal 0) |
| Port C, Port D                 | Input ports                               |
| /PORT C STATUS, /PORT D STATUS | "Low"                                     |
| /OUTPUT 1, /OUTPUT 2           | "High"                                    |
| /SWEEP END                     | "High"                                    |
| /PASS_FAIL                     | "High"                                    |

SCPI commands: `CONTROL:HANDler:RESet` (resets all configurable signals)

#### 9.1.4.4 Timing of Control Signals

The timing of the essential measurement control signals is shown in the figure below. The duration of the shaded time intervals depends on the measurement settings.

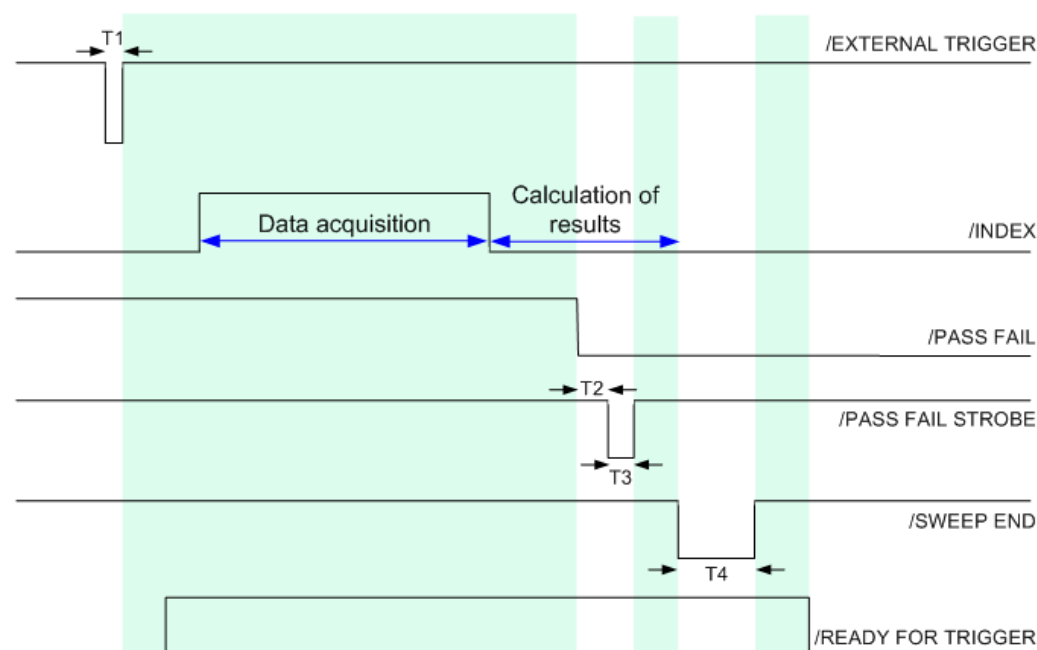

Figure 9-8: Timing of measurement control signals

The figure above corresponds to the default configuration of the /PASS FAIL signal. For alternative configurations refer to the documentation of the `CONTROL:HANDler:PASSfail...` commands in [Chapter 6.3.4, "CONTROL Commands"](#), on page 499. The figure contains the following pulse durations and response times.

| Time | Description                         | Value                    |
|------|-------------------------------------|--------------------------|
| T1   | Pulse duration of /EXTERNAL TRIGGER | Minimum value: 1 $\mu$ s |
| T2   | Response time of /PASS FAIL STROBE  | 1 $\mu$ s                |
| T3   | Pulse duration of /PASS FAIL STROBE | 1 $\mu$ s                |
| T4   | Pulse duration of /SWEEP END        | 12 $\mu$ s               |

The timing of the data port signals and the input/output signals is as follows:

- The low pulse of the /WRITE STROBE signal occurs approx. 0.1  $\mu$ s after a value is written to the output ports A to D. The pulse duration of the /WRITE STROBE signal is 1  $\mu$ s.
- The low pulse of the /OUTPUT 1 or /OUTPUT 2 signals (if enabled) occur approx. 0.6  $\mu$ s after the falling edge of the /INPUT 1 signal.

## 9.2 Maintenance

The R&S ZNC/ZND vector network analyzer does not require any special maintenance.

For our support center address and a list of useful R&S contact addresses refer to the documentation CD-ROM or the "Contact" page at the beginning of the Help system.

### 9.2.1 Storing and Packing the Instrument

The vector network analyzer can be stored at the temperature range quoted in the data sheet. When it is stored for a longer period of time the unit should be protected against dust.

### 9.2.2 Replacing Fuses

The R&S ZNC is protected by two time lag fuses (IEC60127 T3.15H / 250 V, stock no. 0099.6729.00), located in the fuse drawer below the AC power switch on the rear panel. For the R&S ZND there are no such fuses.

#### **WARNING**

##### **Shock hazard**

Before replacing a fuse, make sure that the instrument is switched off and disconnected from all power supplies.

Always use fuses supplied by Rohde & Schwarz as spare parts, or fuses of the same type and rating.



**To replace the fuses**

1. Use a small screwdriver to bend the small clamps on both sides of the fuse drawer inward so that you can lift the fuse drawer out of its slot.
2. Exchange the fuses.
3. Push the drawer back into the slot.

## 9.3 Showroom Mode

In "Showroom Mode" the R&S ZNC/ZND uses a configurable recall set whenever the device is (re-)started or the PRESET key is pressed. However, it can only be enabled by directly editing the Windows registry.

1. Run the R&S ZNC/ZND and configure it as required for the intended showroom operation.
2. Save the configuration as described in [Chapter 4.1.1, "File > Recall Sets"](#), on page 120. If necessary, move the recall set (\*.znx file) to the appropriate location.
3. Under the registry key  
HKEY\_LOCAL\_MACHINE/SOFTWARE/Rohde-Schwarz/Vna create a new subkey ShowroomMode.
4. Within the ShowroomMode-subkey, create the string value ShowroomSetup.
5. Modify the value ShowroomSetup: set its value data to the full path of the recall set. Use forward slashes as path separators, e.g. "C:/Documents and Settings/All Users/Rohde-Schwarz/Vna/RecallSets/ShowroomSet1.znx".

After the analyzer is restarted or "Preset", the specified recall set is loaded.

## 9.4 ENA Emulation Commands

The following table lists the commands implemented/overwritten for the ENA remote language.

| ENA Emulation Command                                                                                                              | R&S ZNC/ZND Default Parser Command   |
|------------------------------------------------------------------------------------------------------------------------------------|--------------------------------------|
| :CALCulate{1...4}[:SElected]:DATA:FDATA?<br>:CALCulate{1...4}[:SElected]:DATA:SDATA?<br>:CALCulate{1...4}[:SElected]:DATA:FMEMory? | CALCulate<Chn>:DATA                  |
| :CALCulate{1...4}[:SElected]:LIMit:DISPlay[:STATe]<br>{ON OFF 1 0}                                                                 | CALCulate<Chn>:LIMit:DISPlay[:STATe] |
| :CALCulate{1...4}[:SElected]:LIMit:FAIL?                                                                                           | CALCulate<Chn>:LIMit:FAIL?           |

| ENA Emulation Command                                                                                               | R&S ZNC/ZND Default Parser Command           |
|---------------------------------------------------------------------------------------------------------------------|----------------------------------------------|
| :CALCulate{1...4}[:SElected]:LIMit[:STATe] {ON OFF 1 0}                                                             | CALCulate<Chn>:LIMit:STATe                   |
| :CALCulate{1...4}[:SElected]:MARKer{1...10}:COUple {ON OFF 1 0}                                                     | CALCulate<Chn>:MARKer<Mk>:COUpled[:STATe]    |
| :CALCulate{1...4}[:SElected]:MARKer{1...10}:FUNction:TYPE {MAXimum MINimum PEAK LPEak RPEak TARGet LTARget RTARget} | CALCulate<Chn>:MARKer<Mk>:FUNction[:SElect]  |
| :CALCulate{1...4}[:SElected]:MARKer{1...10}:DISCreate {ON OFF 1 0}                                                  | CALCulate<Chn>:MARKer<Mk>:MODE               |
| :CALCulate{1...4}[:SElected]:MARKer{1...10}:REFerence[:STATe] {ON OFF 1 0}                                          | CALCulate<Chn>:MARKer<Mk>:REFerence[:STATe]  |
| :CALCulate{1...4}[:SElected]:MARKer{1...10}:FUNction:EXECute                                                        | CALCulate<Chn>:MARKer<Mk>:SEARch[:IMMediate] |
| :CALCulate{1...4}[:SElected]:MARKer{1...10}[:STATe] {ON OFF 1 0}                                                    | CALCulate<Chn>:MARKer<Mk>[:STATe]            |
| :CALCulate{1...4}[:SElected]:MARKer{1...10}:X<numeric>                                                              | CALCulate<Chn>:MARKer<Mk>:X                  |
| :CALCulate{1...4}[:SElected]:MARKer{1...10}:Y?                                                                      | CALCulate<Chn>:MARKer<Mk>:Y?                 |
| :CALCulate{1...4}[:SElected]:MATH:FUNction {NORMal ADD SUBTract MULTiPLY DIVide}                                    | CALCulate<Chn>:MATH:FUNction                 |
| :CALCulate{1...4}[:SElected]:MATH:MEMorize                                                                          | CALCulate<Chn>:MATH:MEMorize                 |
| :CALCulate{1...4}:PARAmeter:COUNT <numeric>                                                                         |                                              |
| :CALCulate{1...4}:PARAmeter{1...7}:DEFine {S11 S21 S31 S41 S12 S22 S32 S42 S13 S23 S33 S43 S14 S24 S34 S44}         | CALCulate<Ch>:PARAmeter:DEFine               |
| :CALCulate{1...4}:PARAmeter{1...7}:SElect [<string>]                                                                | CALCulate<Ch>:PARAmeter:SElect               |
| :CALCulate{1...4}[:SElected]:SMOothing:APERture <numeric>                                                           | CALCulate<Chn>:SMOothing:APERture            |
| :CALCulate{1...4}[:SElected]:SMOothing[:STATe] {ON OFF 1 0}                                                         | CALCulate<Chn>:SMOothing[:STATe]             |
| :CONTrol:HANDler:A[:DATA] <numeric>                                                                                 | CONTrol:HANDler:A[:DATA]                     |
| :CONTrol:HANDler:B[:DATA] <numeric>                                                                                 | CONTrol:HANDler:B[:DATA]                     |
| :CONTrol:HANDler:C[:DATA] <numeric>                                                                                 | CONTrol:HANDler:C[:DATA]                     |
| :CONTrol:HANDler:D[:DATA] <numeric>                                                                                 | CONTrol:HANDler:D[:DATA]                     |
| :CONTrol:HANDler:A:MODE {INPut OUTPut}                                                                              | CONTrol:HANDler:A:MODE                       |
| :CONTrol:HANDler:B:MODE {INPut OUTPut}                                                                              | CONTrol:HANDler:B:MODE                       |
| :CONTrol:HANDler:C:MODE {INPut OUTPut}                                                                              | CONTrol:HANDler:C:MODE                       |
| :CONTrol:HANDler:D:MODE {INPut OUTPut}                                                                              | CONTrol:HANDler:D:MODE                       |

| ENA Emulation Command                                            | R&S ZNC/ZND Default Parser Command                     |
|------------------------------------------------------------------|--------------------------------------------------------|
| :CONTRol:HANDler[:EXTension]:INDex:STATe {ON OFF 1 0}            | CONTRol:HANDler[:EXTension]:INDex:STATe                |
| :CONTRol:HANDler:OUTPut{1...2}[:DATA] {1 0}                      | CONTRol:HANDler:OUTPut<Pt>[:DATA]                      |
| :DISPlay:ANNotation:FREQUency[:STATe] {ON OFF 1 0}               | DISPlay:ANNotation:FREQUency[:STATe]                   |
| :DISPlay:ENABLE {ON OFF 1 0}                                     | SYSTem:DISPlay:UPDate                                  |
| :DISPlay:WINDow{1...4}:ACTivate <numeric_value>                  | INSTrument:NSElect                                     |
| :DISPlay:WINDow{1...4}:MAXimize {ON OFF 1 0}                     | DISPlay[:WINDow<Wnd>]:MAXimize                         |
| :DISPlay:WINDow{1...4}:TITLe:DATA <string>                       | DISPlay[:WINDow<Wnd>]:TITLe:DATA                       |
| :DISPlay:WINDow{1...4}:TITLe[:STATe] {ON OFF 1 0}                | DISPlay[:WINDow<Wnd>]:TITLe[:STATe]                    |
| :DISPlay:WINDow{1...4}:TRACe{1...7}:Y[:SCALE]:AUTO               | DISPlay[:WINDow<Wnd>]:TRACe<WndTr>:Y[:SCALE]:AUTO      |
| :DISPlay:WINDow{1...4}:Y[:SCALE]:DIVisions <numeric>             | DISPlay[:WINDow<Wnd>]:TRACe<WndTr>:Y[:SCALE]:PDIVision |
| :DISPlay:WINDow{1...4}:Y[:SCALE]:RLEVel <numeric>                | DISPlay[:WINDow<Wnd>]:TRACe<WndTr>:Y[:SCALE]:RLEVel    |
| :DISPlay:WINDow{1...4}:TRACe{1...7}:Y[:SCALE]:RPOStion <numeric> | DISPlay[:WINDow<Wnd>]:TRACe<WndTr>:Y[:SCALE]:RPOStion  |
| :FORMat:BORDER {NORMal SWAPped}                                  | FORMat:BORDER                                          |
| :FORMat:DATA {ASCIi REAL}                                        | FORMat[:DATA]                                          |
| :INITiate{1...4}:CONTInuous {ON OFF 1 0}                         | INITiate<Ch>:CONTInuous                                |
| :INITiate{1...4}[:IMMediate]                                     | INITiate<Ch>[:IMMediate][:DUMMy]                       |
| :MMEMory:CATalog? <string>                                       | MMEMory:CATalog?                                       |
| :MMEMory:COpy <string 1> <string 2>                              | MMEMory:COpy                                           |
| :MMEMory:DELeTe <string>                                         | MMEMory:DELeTe                                         |
| :MMEMory:LOAD:LIMit <string>                                     | MMEMory:LOAD:LIMit                                     |
| :MMEMory:LOAD:SEGMENT <string>                                   | MMEMory:LOAD:SEGMENT                                   |
| :MMEMory:LOAD[:STATe] <string>                                   | MMEMory:LOAD:STATe                                     |
| :MMEMory:MDIRectory <string>                                     | MMEMory:MDIRectory                                     |
| :MMEMory:STORE:LIMit <string>                                    | MMEMory:STORE:LIMit                                    |
| :MMEMory:STORE:SEGMENT <string>                                  | MMEMory:STORE:SEGMENT                                  |
| :MMEMory:STORE[:STATe] <string>                                  | MMEMory:STORE:STATe                                    |
| :MMEMory:STORE:FDATa <string>                                    | MMEMory:STORE:TRACe                                    |
| :SENSe{1...4}:AVERAge:CLEar                                      | [SENSe<Ch>:]AVERAge:CLEar                              |

| ENA Emulation Command                                                                                                                                                                                                                                                                                                                                                                                                                                                                                                                                                                                                                          | R&S ZNC/ZND Default Parser Command                    |
|------------------------------------------------------------------------------------------------------------------------------------------------------------------------------------------------------------------------------------------------------------------------------------------------------------------------------------------------------------------------------------------------------------------------------------------------------------------------------------------------------------------------------------------------------------------------------------------------------------------------------------------------|-------------------------------------------------------|
| :SENSe{1...4}:AVERAge:COUNT <numeric>                                                                                                                                                                                                                                                                                                                                                                                                                                                                                                                                                                                                          | [SENSe<Ch>:]AVERAge:COUNT                             |
| :SENSe{1...4}:AVERAge[:STATe] {ON OFF 1 0}                                                                                                                                                                                                                                                                                                                                                                                                                                                                                                                                                                                                     | [SENSe<Ch>:]AVERAge[:STATe]                           |
| :SENSe{1...4}:BWiDth[:RESolution] <bandwidth>                                                                                                                                                                                                                                                                                                                                                                                                                                                                                                                                                                                                  | [SENSe<Ch>:]BWiDth[:RESolution]                       |
| :SENSe{1...4}:CORRection:COL-<br>Lect[:ACQuire]:LOAD <numeric><br>:SENSe{1...4}:CORRection:COL-<br>Lect[:ACQuire]:OPEN <numeric><br>:SENSe{1...4}:CORRection:COL-<br>Lect[:ACQuire]:SHORt <numeric><br>:SENSe{1...4}:CORRection:COL-<br>Lect[:ACQuire]:ISOLation <numeric1>, <numeric2><br>:SENSe{1...4}:CORRection:COL-<br>Lect[:ACQuire]:THRU <numeric1>, <numeric2>                                                                                                                                                                                                                                                                         | [SENSe<Ch>:]CORRection:COLLect[:<br>ACQuire]:SELected |
| :SENSe{1...4}:CORRection:COLLect:ECAL:ISOLa-<br>tion[:STATe] {ON OFF 1 0}<br>:SENSe{1...4}:CORRection:COLLect:ECAL:SOLT1<br><numeric><br>:SENSe{1...4}:CORRection:COLLect:ECAL:SOLT2<br><numeric1>, <numeric2><br>:SENSe{1...4}:CORRection:COLLect:ECAL:SOLT3<br><numeric1>, <numeric2>, <numeric3><br>:SENSe{1...4}:CORRection:COLLect:ECAL:SOLT4<br>1,2,3,4                                                                                                                                                                                                                                                                                  | [SENSe<Ch>:]CORRection:COLLect:AUTO:<br>TYPE          |
| :SENSe{1...4}:CORRection:COL-<br>Lect:MEtHod[:RESPOse]:OPEN <numeric><br>:SENSe{1...4}:CORRection:COL-<br>Lect:MEtHod[:RESPOse]:SHORt <numeric><br>:SENSe{1...4}:CORRection:COL-<br>Lect:MEtHod:SOLT1 <numeric><br>:SENSe{1...4}:CORRection:COL-<br>Lect:MEtHod:SOLT2 <numeric1>, <numeric2><br>:SENSe{1...4}:CORRection:COL-<br>Lect:MEtHod:SOLT3 <numeric1>, <numeric2>,<br><numeric3><br>:SENSe{1...4}:CORRection:COL-<br>Lect:MEtHod:SOLT4 1,2,3,4<br>:SENSe{1...4}:CORRection:COL-<br>Lect:MEtHod[:RESPOse]:THRU <numeric1>,<br><numeric2><br>:SENSe{1...4}:CORRection:COL-<br>Lect:MEtHod:TYPE?<br>:SENSe{1...4}:CORRection:TYPE{1...4}? | [SENSe<Ch>:]CORRection:COLLect:MEtHod:<br>DEFine      |
| :SENSe{1...4}:CORRection:COLLect:SAVE                                                                                                                                                                                                                                                                                                                                                                                                                                                                                                                                                                                                          | [SENSe<Ch>:]CORRection:COLLect:SAVE[:<br>DUMMy]       |
| :SENSe{1...4}:CORRection:EXTension:PORT{[1 2 <br>3 4]:TIME <numeric>                                                                                                                                                                                                                                                                                                                                                                                                                                                                                                                                                                           | [SENSe<Ch>:]CORRection:EDeLay<PhyPt>[:<br>TIME]       |
| :SENSe{1...4}:CORRection:STATe {ON OFF 1 0}                                                                                                                                                                                                                                                                                                                                                                                                                                                                                                                                                                                                    | [SENSe<Ch>:]CORRection[:STATe]                        |

## ENA Emulation Commands

| ENA Emulation Command                                                                                                                    | R&S ZNC/ZND Default Parser Command                      |
|------------------------------------------------------------------------------------------------------------------------------------------|---------------------------------------------------------|
| :SENSe{1...4}:FREQUency:CENTer <numeric>                                                                                                 | [SENSe<Ch>:]FREQUency:CENTer                            |
| :SENSe{1...4}:FREQUency:DATA?                                                                                                            | CALCulate<Chn>:DATA:STIMulus?                           |
| :SENSe{1...4}:FREQUency:SPAN <numeric>                                                                                                   | [SENSe<Ch>:]FREQUency:SPAN                              |
| :SENSe{1...4}:FREQUency:STARt <numeric>                                                                                                  | [SENSe<Ch>:]FREQUency:STARt                             |
| :SENSe{1...4}:FREQUency:STOP <numeric>                                                                                                   | [SENSe<Ch>:]FREQUency:STOP                              |
| :SENSe{1...4}:ROSCillator:SOURce?                                                                                                        | [SENSe<Ch>:]ROSCillator[:SOURce]                        |
| :SENSe{1...4}:SEGMENT:SWEep:POINTs?                                                                                                      | [SENSe<Ch>:]SEGMENT<Seg>:SWEep:POINTs                   |
| :SENSe{1...4}:SEGMENT:SWEep:TIME?                                                                                                        | [SENSe<Ch>:]SEGMENT<Seg>:SWEep:TIME                     |
| :SENSe{1...4}:SEGMENT:DATA<br>5,<mode>,<ifbw>,<pow>,<del>,<time>,<segm>,<star 1>,<stop 1>,<nop 1>,<ifbw 1>,<pow 1>,<del 1>,<time 1>,..., |                                                         |
| :SENSe{1...4}:SWEep:DELay <numeric>                                                                                                      | [SENSe<Ch>:]SWEep:DWELL                                 |
| :SENSe{1...4}:SWEep:POINTs <numeric>                                                                                                     | [SENSe<Ch>:]SWEep:POINTs                                |
| :SENSe{1...4}:SWEep:TIME[:DATA] <numeric>                                                                                                | [SENSe<Ch>:]SWEep:TIME                                  |
| :SENSe{1...4}:SWEep:TIME:AUTO {ON OFF 1 0}                                                                                               | [SENSe<Ch>:]SWEep:TIME:AUTO                             |
| :SENSe{1...4}:SWEep:TYPE {LINear SEGMENT}                                                                                                | [SENSe<Ch>:]SWEep:TYPE                                  |
| :SOURce{1...4}:POWER[:LEVel][:IMMediate][:AMPLI-tude] <numeric>                                                                          | SOURce<Ch>:POWER<PhyPt>[:LEVel][:IMMediate][:AMPLitude] |
| :STATus:OPERation:CONDition?                                                                                                             | STATus:QUESTionable:CONDition?                          |
| :STATus:OPERation:ENABLE <numeric>                                                                                                       | STATus:QUESTionable:ENABle                              |
| :STATus:OPERation[:EVENT]?                                                                                                               | STATus:QUESTionable[:EVENT]?                            |
| :STATus:QUESTionable:NTRansition <numeric>                                                                                               | STATus:QUESTionable:NTRansition                         |
| :STATus:QUESTionable:PTRansition <numeric>                                                                                               | STATus:QUESTionable:LIMit<Lev>:PTRansition              |
| :STATus:QUESTionable:LIMit:CONDition?                                                                                                    | STATus:QUESTionable:LIMit<Lev>:CONDition?               |
| :STATus:QUESTionable:LIMit:ENABLE <numeric>                                                                                              | STATus:QUESTionable:LIMit<Lev>:ENABle                   |
| :STATus:QUESTionable:LIMit[:EVENT]?                                                                                                      | STATus:QUESTionable:LIMit<Lev>[:EVENT]?                 |
| :STATus:QUESTionable:LIMit:NTRansition <numeric>                                                                                         | STATus:QUESTionable:LIMit<Lev>:NTRansition              |
| :STATus:QUESTionable:LIMit:PTRansition <numeric>                                                                                         | STATus:QUESTionable:LIMit<Lev>:PTRansition              |
| :SYSTem:KLOCK:KBD {ON OFF 1 0}                                                                                                           | SYSTem:KLOCK                                            |
| :TRIGger[:SEQuence]:SOURce {INTernal EXTernal MANual BUS}                                                                                | TRIGger<Ch>[:SEQuence]:SOURce                           |

## Glossary: Frequently Used Terms

### A

**Active channel:** Channel belonging to the active trace. The active channel is highlighted in the channel list below the diagram. The active channel is not relevant in remote control where each channel can contain an active trace.

**Active marker:** Marker that can be changed using the settings of the Marker menu (Delta Mode, Ref. Mkr -> Mkr, Mkr Format). The active marker is also used for the Marker Functions. It appears in the diagram with an enlarged marker symbol and font size and with a dot placed in front of the marker line in the info field.

**Active menu:** The menu containing the last executed command. If the softkey bar is displayed (Display - Config./View - Softkey Labels on), then the active menu is indicated on top of the softkey bar.

**Active trace (manual control):** Trace that is selected to apply the settings in the Trace menu. The active trace is highlighted in the trace list of the active diagram area. It can be different from the active trace in remote control.

**Active trace (remote control):** One trace of each channel that has been selected as the active trace (`CALCulate<Ch>:PARAmeter:SElect <trace name>`). Many commands (e.g. `TRACE . . .`) act on the active trace. It can be different from the active trace in manual control.

### C

**Cal pool:** The cal pool is a collection of correction data sets (cal groups) that the analyzer stores in a common directory. Cal groups in the pool can be applied to different channels and recall sets.

**Calibration:** The process of removing systematic errors from the measurement (system error correction). See also TOSM, TOM, TRM, TRL, TNA...

**Calibration kit:** Set of physical calibration standards for a particular connector family.

**Calibration standard:** Physical device that has a known or predictable magnitude and phase response within a given frequency range. Calibration standards are grouped into several types (open, through, match,...) corresponding to the different input quantities for the analyzer's error models.

**Calibration unit:** Integrated solution for automatic calibration of multiple ports (accessories R&S ZV-Zxx, R&S ZN-Z5x and R&S ZN-Z15x). The unit contains calibration standards that are electronically switched when a calibration is performed.

**Channel:** A channel contains hardware-related settings to specify how the network analyzer collects data. Each channel is stored in an independent data set. The channel

settings complement the definitions of the Trace menu; they apply to all traces assigned to the channel.

**Compression point:** The x-dB compression point of an S-parameter or ratio is the stimulus signal level where the magnitude of the measured quantity has dropped by x dB compared to its value at small stimulus signal levels (small-signal value).

**Confirmation dialog box:** Standard dialog box that pops up to display an error message or a warning. The current action can be either continued (OK) or cancelled (Cancel) on closing the dialog box.

**Crosstalk:** The occurrence of a signal at the receive port of the analyzer which did not travel through the test setup and the DUT but leaks through other internal paths. Crosstalk causes an isolation error in the measurement which can be corrected by means of a calibration.

**CW frequency:** Continuous Wave frequency; fixed stimulus frequency used in Power, CW Time and CW Mode sweeps.

## D

**Data trace:** Trace filled with measurement data and updated after each sweep (dynamic trace).

**Diagram area:** Rectangular portion of the screen used to display traces. Diagram areas are arranged in windows; they are independent of trace and channel settings.

**Directivity error:** Measurement error caused by a coupler or bridge in the analyzer's source port causing part of the generated signal to leak through the forward path into the receive path instead of being transmitted towards the DUT. The directivity error can be corrected by means of a full one port calibration or one of the two-port calibration methods (except normalization).

**Discrete marker:** The stimulus value of a discrete marker always coincides with a sweep point so that the marker does not show interpolated measurement values.

**DUT:** Device under test; generic term for any electrical device or circuit which the vector network analyzer can measure. Typical DUTs are filters, amplifiers, or mixers.

## E

**Excursion:** Difference between the response values at a local maximum (minimum) of the trace and at the two closest local minima (maxima) to the left and to the right.

**Extrapolation:** Calculation of a numeric value for a new sweep point outside the original sweep range from the numeric values of the existing sweep points. The analyzer can extrapolate calibration data, transmission coefficients etc. in order to extend the sweep range. If not otherwise stated, the numeric value of the first (last) sweep point is

assigned to all new points below (above) the original sweep range. See also --> interpolation.

## F

**Forward:** A measurement on a two-port DUT is said to be in forward direction if the source signal (stimulus) is applied to port 1 of the DUT.

## H

**Harmonic:** Integer multiple of the fundamental frequency. The fundamental is the first harmonic, the nth harmonic is n times the frequency of the fundamental.

**Harmonic distortion:** The production of harmonic frequencies (harmonics) by an electronic system when a signal is applied at the input.

**Harmonic grid:** A set of equidistant frequency points  $f_i$  ( $i = 1 \dots n$ ) with spacing  $\Delta(f)$  and the additional condition that  $f_1 = \Delta(f)$ . A harmonic grid is required for low pass time domain transforms.

## I

**Intercept point:** Fictitious lower-tone DUT input/output level where the intermodulation suppression (-->) for a given intermodulation product reaches 0 dB.

**Intermodulation measurement:** Measurement where the DUT is supplied with two RF signals of equal power but different frequencies termed the upper and lower tone. The analyzer measures the frequency-converting behavior of the DUT (--> intermodulation product).

**Intermodulation product:** Special type of emissions of a nonlinear DUT that is supplied with a two-tone RF signal (--> intermodulation measurement). The intermodulation products occur at frequencies which correspond to sums and differences of the upper and lower tone frequencies and their integer multiples.

**Intermodulation suppression:** The ratio of the power of an --> intermodulation product to the power of the lower tone fundamental wave.

**Interpolation:** Calculation of a numeric value for a specific sweep point from the numeric values of the adjacent points. The analyzer can interpolate calibration data, transmission coefficients etc. in order to account for a modified set of sweep points. If not otherwise stated, linear interpolation is used. See also --> extrapolation.

**Isolation error:** Measurement error caused by a crosstalk between the source and receive port of the analyzer.



**L**

**Limit check:** Comparison of the measurement results with the limit lines and display of a pass/fail indication. An acoustic warning can be generated in addition if a limit is exceeded.

**Limit line:** A limit line is a set of data to specify the allowed range for some or all points of a trace. Typically, limit lines are used to check whether a DUT conforms to the rated specifications (conformance testing).

**Load match error:** Measurement error caused by a mismatch of the analyzer's receive (load) port causing part of the signal transmitted through the DUT to be reflected off the receive port so that it is not measured there. The load match error can be corrected by means of a two-port calibration (except normalization).

**M**

**Marker:** Tool for selecting points on the trace and for numerical readout of measured data. A marker is displayed with a symbol (a triangle, a crossbar or a line) on the trace; its coordinates are shown in the marker info field.

**Mathematical trace:** Trace that is calculated according to a mathematical expression, e.g. the one defined in the Define Math dialog. The expression is a mathematical relation between constants and the data or memory traces of the active recall set.

**Measurement point:** Result of the measurement at a specified stimulus value (frequency/power/time).

**Measurement result:** Set of all measurement points acquired in a measurement (e.g. a sweep). The measurement result is displayed in a diagram area and forms a trace.

**Memory trace:** Trace that is associated to a data trace and stored in the memory. Data traces and the associated memory traces share the same channel and scale settings. Alternatively, memory traces can be imported from a file.

**Mixer:** Device that converts an RF signal at one frequency into a signal at another frequency. The frequency that is to be shifted is applied at the RF input and the frequency shifting signal (from a local oscillator, LO) is applied to the RF mixer's LO port, resulting in an output signal at the mixer's Intermediate Frequency (IF) port.

**P**

**Partial measurement:** Measurement at a specified stimulus value maintaining definite hardware settings. Depending on the measurement type, several partial measurements may be needed to obtain a measurement point. A full n-port S-parameter measurement requires n partial measurements with n different drive ports.

**Peak:** Local maximum or local minimum (dip) on the trace. In the Trace - Search menu, it is possible to define a minimum excursion that both types of peaks must have to be considered valid.

**R**

**Recall Set:** A recall set comprises a set of diagram areas with all displayed information that can be stored to a VNA recall set file (\*.znx). Each recall set is displayed in an independent tab.

**Reflection tracking error:** Frequency-dependent variation of the ratio of the reflected wave to the reference wave at a test port when an ideal reflection coefficient (= 1) is measured. The reflection tracking error can be corrected by means of a reflection normalization or one of the more sophisticated calibration methods.

**Reverse:** A measurement on a two-port DUT is said to be in reverse direction if the source signal (stimulus) is applied to port 2 of the DUT.

**S**

**Source match error:** Measurement error caused by a mismatch of the analyzer's source port causing part of the signal reflected off the DUT to be reflected again off the source port so that it is not measured there. The source match error can be corrected by means of a full one-port calibration or a two-port calibration (except normalization).

**Stimulus value:** Value of the sweep variable (frequency/power/time/point number) where a measurement is taken. Also termed sweep point.

**Sweep:** Series of consecutive measurements taken at a specified sequence of stimulus values = series of consecutive measurement points.

**Sweep point:** Value of the sweep variable (stimulus value: frequency/power/time) where a measurement is taken.

**Sweep range:** Continuous range of the sweep variable (frequency/power/time) containing the sweep points where the analyzer takes measurements. In a Segmented Frequency sweep the sweep range can be composed of several parameter ranges or single points.

**Sweep segment:** Continuous frequency range or single frequency point where the analyzer measures at specified instrument settings (generator power, IF bandwidth etc.). In the Segmented Frequency sweep type the entire sweep range can be composed of several sweep segments.

**T**

**TNA:** A calibration type using a Through, a symmetric Network and an Attenuation standard. The properties of the Network and the Attenuation don't have to be known exactly. Like TRL and TRM, TNA is especially useful for DUTs in planar line technology.

**TOM:** A calibration type using three fully known standards (Through, Open, Match), recommended for 2-port measurements on coaxial systems.

**Topology:** Assignment of the physical ports of the VNA to the logical ports used for the measurement of mixed mode S-parameters (balance-unbalance conversion).

**TOSM:** A calibration type using a Through plus the one-port standards Open, Short, Match, to be connected to each calibrated port. Classical 12-term error model, also referred to as SOLT. See also UOSM.

**TRL:** A calibration type using the two-port standards Through and Line, which are both assumed to be ideally matched. Beyond that, the through must be lossless, and its length must be exactly known. Especially useful for DUTs in planar line technology.

**TRM:** A calibration type which requires a low-reflection, low-loss Through standard with an electrical length that may be different from zero, a Reflect, and a Match. Especially useful for DUTs in test fixtures.

**TSM:** A calibration type using three fully known standards (Through, Short, Match), recommended for 2-port measurements on coaxial systems.

## U

**UOSM:** A variant of TOSM calibration using an unknown but reciprocal Through standard. Especially for port combinations with different connector types.

## V

**VNA:** (Vector) Network Analyzer, in particular the R&S ZNC/ZND.

## List of Commands

|                                                                   |     |
|-------------------------------------------------------------------|-----|
| [SENSe:]CORRection:CKIT:<ConnType>:LSElect.....                   | 595 |
| [SENSe:]CORRection:CKIT:<ConnType>:SElect.....                    | 586 |
| [SENSe:]CORRection:CKIT:<OnePortStandardType>:WLABEL:SDATA?.....  | 599 |
| [SENSe:]CORRection:CKIT:<StandardType>.....                       | 590 |
| [SENSe:]CORRection:CKIT:<StandardType>:WLABEL.....                | 598 |
| [SENSe:]CORRection:CKIT:<TwoPortStandard>:WLABEL:SDATA?.....      | 599 |
| [SENSe:]CORRection:CKIT:CATalog?.....                             | 587 |
| [SENSe:]CORRection:CKIT:DELeTe.....                               | 587 |
| [SENSe:]CORRection:CKIT:DMODE.....                                | 594 |
| [SENSe:]CORRection:CKIT:INSTall.....                              | 755 |
| [SENSe:]CORRection:CKIT:LABel.....                                | 588 |
| [SENSe:]CORRection:CKIT:LCATalog?.....                            | 596 |
| [SENSe:]CORRection:CKIT:LDELeTe.....                              | 596 |
| [SENSe:]CORRection:CKIT:LLABel.....                               | 597 |
| [SENSe:]CORRection:CKIT:LSElect.....                              | 597 |
| [SENSe:]CORRection:CKIT:SElect.....                               | 589 |
| [SENSe:]CORRection:CKIT:STANdard:CATalog?.....                    | 590 |
| [SENSe:]CORRection:CKIT:STANdard:DATA?.....                       | 594 |
| [SENSe:]CORRection:CKIT:STANdard:LCATalog?.....                   | 598 |
| [SENSe:]CORRection:COLLect:AUTO:CKIT.....                         | 604 |
| [SENSe:]CORRection:COLLect:AUTO:CKIT:PASSword.....                | 605 |
| [SENSe:]CORRection:COLLect:AUTO:CKIT:PORTs.....                   | 606 |
| [SENSe:]CORRection:COLLect:AUTO:CKIT:PORTs:ADD.....               | 607 |
| [SENSe:]CORRection:COLLect:AUTO:PORTs:CONNecTion?.....            | 608 |
| [SENSe:]CORRection:COLLect:AVERAge.....                           | 612 |
| [SENSe:]CORRection:COLLect:CHANnels:ALL.....                      | 612 |
| [SENSe:]CORRection:COLLect:CHANnels:MCTYpes.....                  | 613 |
| [SENSe:]CORRection:COLLect:FIXTure:LMPParameter:LOSS[:STATe]..... | 619 |
| [SENSe:]CORRection:COLLect:FIXTure:LMPParameter[:STATe].....      | 620 |
| [SENSe:]CORRection:COLLect:PMETer:ID.....                         | 624 |
| [SENSe:]SWEep:COUNT:ALL.....                                      | 672 |
| [SENSe<Ch>:]AVERAge:CLEar.....                                    | 581 |
| [SENSe<Ch>:]AVERAge:COUNT.....                                    | 582 |
| [SENSe<Ch>:]AVERAge:MODE.....                                     | 582 |
| [SENSe<Ch>:]AVERAge[:STATe].....                                  | 582 |
| [SENSe<Ch>:]BANDwidth[:RESolution].....                           | 583 |
| [SENSe<Ch>:]BWIDth[:RESolution].....                              | 583 |
| [SENSe<Ch>:]CORRection:CDATA.....                                 | 584 |
| [SENSe<Ch>:]CORRection:CKIT:<ConnType>:<StandardType>.....        | 754 |
| [SENSe<Ch>:]CORRection:COLLect:AUTO.....                          | 603 |
| [SENSe<Ch>:]CORRection:COLLect:AUTO:PORTs.....                    | 608 |
| [SENSe<Ch>:]CORRection:COLLect:AUTO:PORTs:TYPE.....               | 609 |
| [SENSe<Ch>:]CORRection:COLLect:AUTO:POWER.....                    | 610 |
| [SENSe<Ch>:]CORRection:COLLect:AUTO:TYPE.....                     | 611 |
| [SENSe<Ch>:]CORRection:COLLect:CKIT:INSTall.....                  | 588 |
| [SENSe<Ch>:]CORRection:COLLect:CKIT:LOAD.....                     | 588 |
| [SENSe<Ch>:]CORRection:COLLect:CKIT:PORT<PhyPt>?.....             | 589 |

|                                                                |     |
|----------------------------------------------------------------|-----|
| [SENSe<Ch>:]CORRection:COLLect:CONNection:GENDerS.....         | 615 |
| [SENSe<Ch>:]CORRection:COLLect:CONNection:PORTS.....           | 616 |
| [SENSe<Ch>:]CORRection:COLLect:CONNection<PhyPt>.....          | 614 |
| [SENSe<Ch>:]CORRection:COLLect:DELeTe.....                     | 616 |
| [SENSe<Ch>:]CORRection:COLLect:FIXTure:EXPort.....             | 618 |
| [SENSe<Ch>:]CORRection:COLLect:FIXTure:IMPort.....             | 618 |
| [SENSe<Ch>:]CORRection:COLLect:FIXTure:SAVE.....               | 620 |
| [SENSe<Ch>:]CORRection:COLLect:FIXTure:STARt.....              | 620 |
| [SENSe<Ch>:]CORRection:COLLect:FIXTure[:ACQuire].....          | 617 |
| [SENSe<Ch>:]CORRection:COLLect:LOAD:SELeCted.....              | 621 |
| [SENSe<Ch>:]CORRection:COLLect:METhod.....                     | 757 |
| [SENSe<Ch>:]CORRection:COLLect:METhod:DEFine.....              | 622 |
| [SENSe<Ch>:]CORRection:COLLect:SAVE:DEFault.....               | 757 |
| [SENSe<Ch>:]CORRection:COLLect:SAVE:SELeCted:DEFault.....      | 624 |
| [SENSe<Ch>:]CORRection:COLLect:SAVE:SELeCted[:DUMMy].....      | 625 |
| [SENSe<Ch>:]CORRection:COLLect:SAVE[:DUMMy].....               | 758 |
| [SENSe<Ch>:]CORRection:COLLect:SCONNection<PhyPt>.....         | 626 |
| [SENSe<Ch>:]CORRection:COLLect[:ACQuire].....                  | 756 |
| [SENSe<Ch>:]CORRection:COLLect[:ACQuire]:SELeCted.....         | 601 |
| [SENSe<Ch>:]CORRection:CONNection.....                         | 626 |
| [SENSe<Ch>:]CORRection:CONNection:CATalog?.....                | 627 |
| [SENSe<Ch>:]CORRection:CONNection:DELeTe.....                  | 628 |
| [SENSe<Ch>:]CORRection:DATA.....                               | 759 |
| [SENSe<Ch>:]CORRection:DATA:PARAmeter:COUNt?.....              | 631 |
| [SENSe<Ch>:]CORRection:DATA:PARAmeter<Sfk>?.....               | 628 |
| [SENSe<Ch>:]CORRection:DATE?.....                              | 631 |
| [SENSe<Ch>:]CORRection:EDELay<PhyPt>:AUTO.....                 | 632 |
| [SENSe<Ch>:]CORRection:EDELay<PhyPt>:DIElectric.....           | 633 |
| [SENSe<Ch>:]CORRection:EDELay<PhyPt>:DISTance.....             | 633 |
| [SENSe<Ch>:]CORRection:EDELay<PhyPt>:ELENgth.....              | 633 |
| [SENSe<Ch>:]CORRection:EDELay<PhyPt>[:TIME].....               | 634 |
| [SENSe<Ch>:]CORRection:LOSS<PhyPt>.....                        | 634 |
| [SENSe<Ch>:]CORRection:LOSS<PhyPt>:AUTO.....                   | 635 |
| [SENSe<Ch>:]CORRection:LOSS<PhyPt>:FREQUency.....              | 635 |
| [SENSe<Ch>:]CORRection:LOSS<PhyPt>:OFFSet.....                 | 635 |
| [SENSe<Ch>:]CORRection:OFFSet<PhyPt>:COMPensation[:STATe]..... | 636 |
| [SENSe<Ch>:]CORRection:OFFSet<PhyPt>:DFComp[:STATe]?.....      | 637 |
| [SENSe<Ch>:]CORRection:OFFSet<PhyPt>:MAGNitude.....            | 761 |
| [SENSe<Ch>:]CORRection:OFFSet<PhyPt>[:STATe].....              | 636 |
| [SENSe<Ch>:]CORRection:PCAL.....                               | 638 |
| [SENSe<Ch>:]CORRection:POWEr:DATA.....                         | 639 |
| [SENSe<Ch>:]CORRection:POWEr<PhyPt>:ACQuire.....               | 637 |
| [SENSe<Ch>:]CORRection:POWEr<PhyPt>:AWAVE[:STATe].....         | 639 |
| [SENSe<Ch>:]CORRection:POWEr<PhyPt>[:STATe].....               | 640 |
| [SENSe<Ch>:]CORRection:STIMulus?.....                          | 642 |
| [SENSe<Ch>:]CORRection[:STATe].....                            | 641 |
| [SENSe<Ch>:]COUPlE.....                                        | 642 |
| [SENSe<Ch>:]FREQUency:CENTer.....                              | 643 |
| [SENSe<Ch>:]FREQUency:CONVersion.....                          | 644 |
| [SENSe<Ch>:]FREQUency:CONVersion:GAIN:LMCorrection.....        | 644 |

|                                                           |     |
|-----------------------------------------------------------|-----|
| [SENSe<Ch>:]FREQuency:FIXed.....                          | 645 |
| [SENSe<Ch>:]FREQuency:MODE.....                           | 761 |
| [SENSe<Ch>:]FREQuency:SBANd.....                          | 645 |
| [SENSe<Ch>:]FREQuency:SEGMENT:AXIS.....                   | 646 |
| [SENSe<Ch>:]FREQuency:SPAN.....                           | 647 |
| [SENSe<Ch>:]FREQuency:START.....                          | 647 |
| [SENSe<Ch>:]FREQuency:STOP.....                           | 647 |
| [SENSe<Ch>:]FREQuency[:CW].....                           | 645 |
| [SENSe<Ch>:]HARMonic:AUTO.....                            | 648 |
| [SENSe<Ch>:]HARMonic:DLENgth:DATA.....                    | 648 |
| [SENSe<Ch>:]HARMonic:RTIME:DATA.....                      | 648 |
| [SENSe<Ch>:]HARMonic:RTIME:THREshold.....                 | 649 |
| [SENSe<Ch>:]LPORT<LogPt>:ZCOMMon.....                     | 649 |
| [SENSe<Ch>:]LPORT<LogPt>:ZDEFault[:STATe].....            | 650 |
| [SENSe<Ch>:]LPORT<LogPt>:ZDIFferent.....                  | 649 |
| [SENSe<Ch>:]PORT<PhyPt>:ZREFerence.....                   | 651 |
| [SENSe<Ch>:]POWER:AGCMode:ACQuire.....                    | 653 |
| [SENSe<Ch>:]POWER:AGCMode:SAVE.....                       | 653 |
| [SENSe<Ch>:]POWER:AGCMode<PhyPt>:MEASure.....             | 654 |
| [SENSe<Ch>:]POWER:GAINcontrol.....                        | 652 |
| [SENSe<Ch>:]POWER:GAINcontrol:GLOBal.....                 | 652 |
| [SENSe<Ch>:]POWER:IFGain<PhyPt>:MEASure.....              | 654 |
| [SENSe<Ch>:]ROSCillator:EXTernal:FREQuency.....           | 654 |
| [SENSe<Ch>:]ROSCillator[:SOURce].....                     | 655 |
| [SENSe<Ch>:]SEGMENT:COUNT?.....                           | 658 |
| [SENSe<Ch>:]SEGMENT<Seg>:ADD.....                         | 656 |
| [SENSe<Ch>:]SEGMENT<Seg>:BWIDth[:RESolution].....         | 657 |
| [SENSe<Ch>:]SEGMENT<Seg>:BWIDth[:RESolution]:CONTrol..... | 657 |
| [SENSe<Ch>:]SEGMENT<Seg>:CLEar.....                       | 762 |
| [SENSe<Ch>:]SEGMENT<Seg>:DEFine.....                      | 658 |
| [SENSe<Ch>:]SEGMENT<Seg>:DEFine:SElect.....               | 660 |
| [SENSe<Ch>:]SEGMENT<Seg>:DELEte:ALL.....                  | 660 |
| [SENSe<Ch>:]SEGMENT<Seg>:DELEte[:DUMMy].....              | 661 |
| [SENSe<Ch>:]SEGMENT<Seg>:FREQuency:CENTer?.....           | 661 |
| [SENSe<Ch>:]SEGMENT<Seg>:FREQuency:SPAN?.....             | 661 |
| [SENSe<Ch>:]SEGMENT<Seg>:FREQuency:START.....             | 662 |
| [SENSe<Ch>:]SEGMENT<Seg>:FREQuency:STOP.....              | 662 |
| [SENSe<Ch>:]SEGMENT<Seg>:INSert.....                      | 662 |
| [SENSe<Ch>:]SEGMENT<Seg>:INSert:SElect.....               | 664 |
| [SENSe<Ch>:]SEGMENT<Seg>:OVERlap.....                     | 762 |
| [SENSe<Ch>:]SEGMENT<Seg>:POWER:GAINcontrol.....           | 665 |
| [SENSe<Ch>:]SEGMENT<Seg>:POWER:GAINcontrol:CONTrol.....   | 666 |
| [SENSe<Ch>:]SEGMENT<Seg>:POWER[:LEVel].....               | 665 |
| [SENSe<Ch>:]SEGMENT<Seg>:POWER[:LEVel]:CONTrol.....       | 667 |
| [SENSe<Ch>:]SEGMENT<Seg>:SWEep:DWELl.....                 | 668 |
| [SENSe<Ch>:]SEGMENT<Seg>:SWEep:DWELl:CONTrol.....         | 669 |
| [SENSe<Ch>:]SEGMENT<Seg>:SWEep:POINTs.....                | 669 |
| [SENSe<Ch>:]SEGMENT<Seg>:SWEep:TIME.....                  | 670 |
| [SENSe<Ch>:]SEGMENT<Seg>:SWEep:TIME:CONTrol.....          | 671 |
| [SENSe<Ch>:]SEGMENT<Seg>:SWEep:TIME:SUM?.....             | 671 |

|                                                           |     |
|-----------------------------------------------------------|-----|
| [SENSe<Ch>:]SEGMENT<Seg>[:STATe].....                     | 668 |
| [SENSe<Ch>:]SWEep:COUNT.....                              | 672 |
| [SENSe<Ch>:]SWEep:DETECTOR:TIME.....                      | 673 |
| [SENSe<Ch>:]SWEep:DWELI.....                              | 673 |
| [SENSe<Ch>:]SWEep:DWELI:IPOint.....                       | 674 |
| [SENSe<Ch>:]SWEep:POINts.....                             | 674 |
| [SENSe<Ch>:]SWEep:SPACing.....                            | 762 |
| [SENSe<Ch>:]SWEep:STEP.....                               | 675 |
| [SENSe<Ch>:]SWEep:TIME.....                               | 676 |
| [SENSe<Ch>:]SWEep:TIME:AUTO.....                          | 677 |
| [SENSe<Ch>:]SWEep:TYPE.....                               | 677 |
| [SENSe<Chn>:]CORREction:PSState?.....                     | 642 |
| [SENSe<Chn>:]CORREction:SSState?.....                     | 641 |
| [SENSe<Chn>:]FUNctIon[:ON].....                           | 763 |
| [SENSe<Chn>:]SWEep:SRCPort.....                           | 675 |
| ABORT.....                                                | 402 |
| CALCulate:CLIMits:FAIL?.....                              | 402 |
| CALCulate:DATA:ALL?.....                                  | 407 |
| CALCulate:DATA:DALL?.....                                 | 408 |
| CALCulate:DATA:TRACe.....                                 | 411 |
| CALCulate:FILTer[:GATE]:TIME:AOffset.....                 | 413 |
| CALCulate:LIMit:CIRClE:FAIL:ALL?.....                     | 422 |
| CALCulate:LIMit:FAIL:ALL?.....                            | 427 |
| CALCulate:MARKer:FUNctIon:BWIDth:GMCenter.....            | 440 |
| CALCulate:PARAmeter:DELeTe:ALL.....                       | 462 |
| CALCulate:PARAmeter:DELeTe:MEMory.....                    | 462 |
| CALCulate:RIPPlE:DISPlay:RESult:ALL[:STATe].....          | 470 |
| CALCulate:RIPPlE:FAIL:ALL?.....                           | 471 |
| CALCulate<Ch>:DATA:CALL.....                              | 406 |
| CALCulate<Ch>:DATA:CALL:CATalog?.....                     | 408 |
| CALCulate<Ch>:DATA:CHANnel:ALL?.....                      | 406 |
| CALCulate<Ch>:DATA:CHANnel:DALL?.....                     | 408 |
| CALCulate<Ch>:DATA:SGRoup?.....                           | 411 |
| CALCulate<Ch>:PARAmeter:CATalog:SENDED?.....              | 459 |
| CALCulate<Ch>:PARAmeter:CATalog?.....                     | 459 |
| CALCulate<Ch>:PARAmeter:DEFine.....                       | 748 |
| CALCulate<Ch>:PARAmeter:DEFine:SGRoup.....                | 459 |
| CALCulate<Ch>:PARAmeter:DELeTe.....                       | 461 |
| CALCulate<Ch>:PARAmeter:DELeTe:CALL.....                  | 462 |
| CALCulate<Ch>:PARAmeter:DELeTe:CMEMory.....               | 462 |
| CALCulate<Ch>:PARAmeter:DELeTe:SGRoup.....                | 462 |
| CALCulate<Ch>:PARAmeter:MEASure.....                      | 463 |
| CALCulate<Ch>:PARAmeter:MEASure:SENDED.....               | 463 |
| CALCulate<Ch>:PARAmeter:SDEFine.....                      | 464 |
| CALCulate<Ch>:PARAmeter:SDEFine:SENDED.....               | 466 |
| CALCulate<Ch>:PARAmeter:SElect.....                       | 466 |
| CALCulate<Ch>:TRANSform:VNETworks:FSIMulator[:STATe]..... | 491 |
| CALCulate<Chn>:DATA.....                                  | 403 |
| CALCulate<Chn>:DATA:NSWeep:COUNT?.....                    | 409 |
| CALCulate<Chn>:DATA:NSWeep:FIRSt?.....                    | 409 |

|                                                   |     |
|---------------------------------------------------|-----|
| CALCulate<Chn>:DATA:NSWeep[:LAST]?                | 410 |
| CALCulate<Chn>:DATA:STIMulus?                     | 411 |
| CALCulate<Chn>:DLINe                              | 412 |
| CALCulate<Chn>:DLINe:STATe                        | 412 |
| CALCulate<Chn>:FILTer[:GATE]:TIME:CENTer          | 414 |
| CALCulate<Chn>:FILTer[:GATE]:TIME:DCHebyshev      | 414 |
| CALCulate<Chn>:FILTer[:GATE]:TIME:SHAPE           | 414 |
| CALCulate<Chn>:FILTer[:GATE]:TIME:SHOW            | 415 |
| CALCulate<Chn>:FILTer[:GATE]:TIME:SPAN            | 415 |
| CALCulate<Chn>:FILTer[:GATE]:TIME:START           | 416 |
| CALCulate<Chn>:FILTer[:GATE]:TIME:STATe           | 416 |
| CALCulate<Chn>:FILTer[:GATE]:TIME:STOP            | 416 |
| CALCulate<Chn>:FILTer[:GATE]:TIME:WINDow          | 417 |
| CALCulate<Chn>:FILTer[:GATE]:TIME[:TYPE]          | 417 |
| CALCulate<Chn>:FORMat                             | 417 |
| CALCulate<Chn>:FORMat:WQUType                     | 419 |
| CALCulate<Chn>:GDAPerture:SCOunt                  | 419 |
| CALCulate<Chn>:LIMit:CIRClE:CLEar                 | 422 |
| CALCulate<Chn>:LIMit:CIRClE:DATA                  | 420 |
| CALCulate<Chn>:LIMit:CIRClE:DISPlay[:STATe]       | 421 |
| CALCulate<Chn>:LIMit:CIRClE:FAIL?                 | 421 |
| CALCulate<Chn>:LIMit:CIRClE:SOUNd[:STATe]         | 422 |
| CALCulate<Chn>:LIMit:CIRClE[:STATe]               | 422 |
| CALCulate<Chn>:LIMit:CLEar                        | 434 |
| CALCulate<Chn>:LIMit:CONTRol:DOMain               | 745 |
| CALCulate<Chn>:LIMit:CONTRol:SHIFt                | 424 |
| CALCulate<Chn>:LIMit:CONTRol[:DATA]               | 423 |
| CALCulate<Chn>:LIMit:DATA                         | 424 |
| CALCulate<Chn>:LIMit:DCIRclE:CLEar                | 425 |
| CALCulate<Chn>:LIMit:DCIRclE:DATA                 | 425 |
| CALCulate<Chn>:LIMit:DCIRclE:DISPlay[:STATe]      | 425 |
| CALCulate<Chn>:LIMit:DCIRclE[:STATe]              | 426 |
| CALCulate<Chn>:LIMit:DELete:ALL                   | 426 |
| CALCulate<Chn>:LIMit:DISPlay[:STATe]              | 426 |
| CALCulate<Chn>:LIMit:FAIL?                        | 427 |
| CALCulate<Chn>:LIMit:LOWer:FEED                   | 433 |
| CALCulate<Chn>:LIMit:LOWer:SHIFt                  | 434 |
| CALCulate<Chn>:LIMit:LOWer:STATe                  | 747 |
| CALCulate<Chn>:LIMit:LOWer[:DATA]                 | 432 |
| CALCulate<Chn>:LIMit:RDOMain:COMPlEx              | 746 |
| CALCulate<Chn>:LIMit:RDOMain:FORMat               | 746 |
| CALCulate<Chn>:LIMit:RDOMain:SPACing              | 747 |
| CALCulate<Chn>:LIMit:SEGMENT:COUNT?               | 428 |
| CALCulate<Chn>:LIMit:SEGMENT<Seg>:AMPLitude:START | 428 |
| CALCulate<Chn>:LIMit:SEGMENT<Seg>:AMPLitude:STOP  | 428 |
| CALCulate<Chn>:LIMit:SEGMENT<Seg>:STIMulus:START  | 429 |
| CALCulate<Chn>:LIMit:SEGMENT<Seg>:STIMulus:STOP   | 429 |
| CALCulate<Chn>:LIMit:SEGMENT<Seg>:TYPE            | 430 |
| CALCulate<Chn>:LIMit:SOUNd[:STATe]                | 430 |
| CALCulate<Chn>:LIMit:STATe                        | 430 |



|                                                               |     |
|---------------------------------------------------------------|-----|
| CALCulate<Chn>:LIMit:STATe:AREA.....                          | 431 |
| CALCulate<Chn>:LIMit:TTLout<Pt>[:STATe].....                  | 431 |
| CALCulate<Chn>:LIMit:UPPer:FEED.....                          | 433 |
| CALCulate<Chn>:LIMit:UPPer:SHIFt.....                         | 434 |
| CALCulate<Chn>:LIMit:UPPer:STATe.....                         | 747 |
| CALCulate<Chn>:LIMit:UPPer[:DATA].....                        | 432 |
| CALCulate<Chn>:MARKer:DEFault:FORMat.....                     | 438 |
| CALCulate<Chn>:MARKer:SEARch:BFILter:RESult[:STATe].....      | 449 |
| CALCulate<Chn>:MARKer:SEARch:BFILter:RESult[:STATe]:AREA..... | 449 |
| CALCulate<Chn>:MARKer[:STATe]:AREA.....                       | 452 |
| CALCulate<Chn>:MARKer<Mk>:AOFF.....                           | 435 |
| CALCulate<Chn>:MARKer<Mk>:BWIDth.....                         | 436 |
| CALCulate<Chn>:MARKer<Mk>:COUPled[:STATe].....                | 437 |
| CALCulate<Chn>:MARKer<Mk>:DELTA[:STATe].....                  | 439 |
| CALCulate<Chn>:MARKer<Mk>:FORMat.....                         | 439 |
| CALCulate<Chn>:MARKer<Mk>:FUNCTion:BWIDth.....                | 749 |
| CALCulate<Chn>:MARKer<Mk>:FUNCTion:BWIDth:MODE.....           | 440 |
| CALCulate<Chn>:MARKer<Mk>:FUNCTion:CENTer.....                | 441 |
| CALCulate<Chn>:MARKer<Mk>:FUNCTion:DELTA:STATe.....           | 749 |
| CALCulate<Chn>:MARKer<Mk>:FUNCTion:DOMain:USER:SHOW.....      | 442 |
| CALCulate<Chn>:MARKer<Mk>:FUNCTion:DOMain:USER:STARt.....     | 442 |
| CALCulate<Chn>:MARKer<Mk>:FUNCTion:DOMain:USER:STOP.....      | 442 |
| CALCulate<Chn>:MARKer<Mk>:FUNCTion:DOMain:USER[:RANGe].....   | 441 |
| CALCulate<Chn>:MARKer<Mk>:FUNCTion:EXECute.....               | 443 |
| CALCulate<Chn>:MARKer<Mk>:FUNCTion:RESult?.....               | 444 |
| CALCulate<Chn>:MARKer<Mk>:FUNCTion:SPAN.....                  | 444 |
| CALCulate<Chn>:MARKer<Mk>:FUNCTion:STARt.....                 | 445 |
| CALCulate<Chn>:MARKer<Mk>:FUNCTion:STOP.....                  | 445 |
| CALCulate<Chn>:MARKer<Mk>:FUNCTion:TARGet.....                | 750 |
| CALCulate<Chn>:MARKer<Mk>:FUNCTion[:SELect].....              | 750 |
| CALCulate<Chn>:MARKer<Mk>:MAXimum.....                        | 751 |
| CALCulate<Chn>:MARKer<Mk>:MINimum.....                        | 751 |
| CALCulate<Chn>:MARKer<Mk>:MODE.....                           | 445 |
| CALCulate<Chn>:MARKer<Mk>:NAME.....                           | 446 |
| CALCulate<Chn>:MARKer<Mk>:REFerence:MODE.....                 | 446 |
| CALCulate<Chn>:MARKer<Mk>:REFerence:NAME.....                 | 447 |
| CALCulate<Chn>:MARKer<Mk>:REFerence:TYPE.....                 | 447 |
| CALCulate<Chn>:MARKer<Mk>:REFerence:X.....                    | 448 |
| CALCulate<Chn>:MARKer<Mk>:REFerence:Y?.....                   | 449 |
| CALCulate<Chn>:MARKer<Mk>:REFerence[:STATe].....              | 447 |
| CALCulate<Chn>:MARKer<Mk>:SEARch:FORMat.....                  | 450 |
| CALCulate<Chn>:MARKer<Mk>:SEARch:LEFT.....                    | 751 |
| CALCulate<Chn>:MARKer<Mk>:SEARch:NEXT.....                    | 751 |
| CALCulate<Chn>:MARKer<Mk>:SEARch:RIGHT.....                   | 751 |
| CALCulate<Chn>:MARKer<Mk>:SEARch:TRACKing.....                | 450 |
| CALCulate<Chn>:MARKer<Mk>:SEARch[:IMMediate].....             | 751 |
| CALCulate<Chn>:MARKer<Mk>:TARGet.....                         | 452 |
| CALCulate<Chn>:MARKer<Mk>:TYPE.....                           | 453 |
| CALCulate<Chn>:MARKer<Mk>:X.....                              | 453 |
| CALCulate<Chn>:MARKer<Mk>:Y?.....                             | 454 |

|                                                                |     |
|----------------------------------------------------------------|-----|
| CALCulate<Chn>:MARKer<Mk>[:STATe].....                         | 451 |
| CALCulate<Chn>:MATH:FUNCTion.....                              | 456 |
| CALCulate<Chn>:MATH:MEMorize.....                              | 456 |
| CALCulate<Chn>:MATH:STATe.....                                 | 457 |
| CALCulate<Chn>:MATH:WUNit[:STATe].....                         | 457 |
| CALCulate<Chn>:MATH[:EXPReSSion]:SDEFine.....                  | 455 |
| CALCulate<Chn>:MATH[:EXPReSSion]:DEFine].....                  | 752 |
| CALCulate<Chn>:PHOLd.....                                      | 467 |
| CALCulate<Chn>:RIPPlE:CLEar.....                               | 476 |
| CALCulate<Chn>:RIPPlE:CONTRol:DOMain.....                      | 468 |
| CALCulate<Chn>:RIPPlE:DATA.....                                | 469 |
| CALCulate<Chn>:RIPPlE:DELeTe:ALL.....                          | 469 |
| CALCulate<Chn>:RIPPlE:DISPlay[:STATe].....                     | 470 |
| CALCulate<Chn>:RIPPlE:FAIL?.....                               | 471 |
| CALCulate<Chn>:RIPPlE:RDOMain:FORMat.....                      | 471 |
| CALCulate<Chn>:RIPPlE:SEGMENT:COUNT?.....                      | 472 |
| CALCulate<Chn>:RIPPlE:SEGMENT<Seg>:LIMit.....                  | 472 |
| CALCulate<Chn>:RIPPlE:SEGMENT<Seg>:RESult?.....                | 473 |
| CALCulate<Chn>:RIPPlE:SEGMENT<Seg>:STIMulus:START.....         | 474 |
| CALCulate<Chn>:RIPPlE:SEGMENT<Seg>:STIMulus:STOP.....          | 474 |
| CALCulate<Chn>:RIPPlE:SEGMENT<Seg>[:STATe].....                | 474 |
| CALCulate<Chn>:RIPPlE:SOUNd[:STATe].....                       | 475 |
| CALCulate<Chn>:RIPPlE:STATe.....                               | 475 |
| CALCulate<Chn>:RIPPlE:STATe:AREA.....                          | 475 |
| CALCulate<Chn>:SMOothing:APERture.....                         | 476 |
| CALCulate<Chn>:SMOothing[:STATe].....                          | 477 |
| CALCulate<Chn>:STATistics:DOMain:USER.....                     | 477 |
| CALCulate<Chn>:STATistics:DOMain:USER:SHOW.....                | 478 |
| CALCulate<Chn>:STATistics:DOMain:USER:START.....               | 478 |
| CALCulate<Chn>:STATistics:DOMain:USER:STOP.....                | 478 |
| CALCulate<Chn>:STATistics:EPDelay[:STATe].....                 | 479 |
| CALCulate<Chn>:STATistics:FORMat.....                          | 479 |
| CALCulate<Chn>:STATistics:MMPTpeak[:STATe].....                | 479 |
| CALCulate<Chn>:STATistics:MSTDdev[:STATe].....                 | 479 |
| CALCulate<Chn>:STATistics:NLINear:COMP:LEVEL.....              | 479 |
| CALCulate<Chn>:STATistics:NLINear:COMP:RESult?.....            | 480 |
| CALCulate<Chn>:STATistics:NLINear:COMP[:STATe].....            | 480 |
| CALCulate<Chn>:STATistics:RESult?.....                         | 480 |
| CALCulate<Chn>:STATistics:RMS[:STATe].....                     | 481 |
| CALCulate<Chn>:STATistics:SFLatness[:STATe].....               | 481 |
| CALCulate<Chn>:STATistics[:STATe].....                         | 482 |
| CALCulate<Chn>:STATistics[:STATe]:AREA.....                    | 482 |
| CALCulate<Chn>:TRANSform:COMPLex.....                          | 483 |
| CALCulate<Chn>:TRANSform:IMPedance:RNORMAL.....                | 484 |
| CALCulate<Chn>:TRANSform:TIME:CENTer.....                      | 484 |
| CALCulate<Chn>:TRANSform:TIME:DCHebyshev.....                  | 485 |
| CALCulate<Chn>:TRANSform:TIME:LPASS.....                       | 485 |
| CALCulate<Chn>:TRANSform:TIME:LPASS:DCSPParam.....             | 486 |
| CALCulate<Chn>:TRANSform:TIME:LPASS:DCSPParam:CONTInuous.....  | 486 |
| CALCulate<Chn>:TRANSform:TIME:LPASS:DCSPParam:EXTRapolate..... | 487 |

|                                                       |     |
|-------------------------------------------------------|-----|
| CALCulate<Chn>:TRANSform:TIME:LPFRequency.....        | 487 |
| CALCulate<Chn>:TRANSform:TIME:RESolution:EFACtor..... | 487 |
| CALCulate<Chn>:TRANSform:TIME:SPAN.....               | 488 |
| CALCulate<Chn>:TRANSform:TIME:STARt.....              | 488 |
| CALCulate<Chn>:TRANSform:TIME:STATe.....              | 489 |
| CALCulate<Chn>:TRANSform:TIME:STIMulus.....           | 489 |
| CALCulate<Chn>:TRANSform:TIME:STOP.....               | 489 |
| CALCulate<Chn>:TRANSform:TIME:WINDow.....             | 490 |
| CALCulate<Chn>:TRANSform:TIME:XAXis.....              | 491 |
| CALCulate<Chn>:TRANSform:TIME[:TYPE].....             | 490 |
| CONFigure:CHANnel:CATalog?.....                       | 492 |
| CONFigure:CHANnel:MEASure:ALL[:STATe].....            | 492 |
| CONFigure:CHANnel<Ch>:MEASure[:STATe].....            | 493 |
| CONFigure:CHANnel<Ch>:NAME.....                       | 493 |
| CONFigure:CHANnel<Ch>:NAME:ID?.....                   | 493 |
| CONFigure:CHANnel<Ch>:TRACe:CATalog?.....             | 494 |
| CONFigure:CHANnel<Ch>:TRACe:REName.....               | 495 |
| CONFigure:CHANnel<Ch>[:STATe].....                    | 494 |
| CONFigure:TRACe:CATalog?.....                         | 495 |
| CONFigure:TRACe:WINDow:TRACe?.....                    | 498 |
| CONFigure:TRACe:WINDow?.....                          | 498 |
| CONFigure:TRACe<Trc>:CHANnel:NAME:ID?.....            | 496 |
| CONFigure:TRACe<Trc>:CHANnel:NAME?.....               | 496 |
| CONFigure:TRACe<Trc>:NAME.....                        | 497 |
| CONFigure:TRACe<Trc>:NAME:ID?.....                    | 497 |
| CONFigure:TRACe<Trc>:REName.....                      | 497 |
| CONTRol:AUXiliary:C[:DATA].....                       | 499 |
| CONTRol:GPIO:SENSe:SUMCurrent?.....                   | 507 |
| CONTRol:HANDler:A:MODE.....                           | 501 |
| CONTRol:HANDler:A[:DATA].....                         | 501 |
| CONTRol:HANDler:B:MODE.....                           | 501 |
| CONTRol:HANDler:B[:DATA].....                         | 501 |
| CONTRol:HANDler:C:MODE.....                           | 502 |
| CONTRol:HANDler:C[:DATA].....                         | 501 |
| CONTRol:HANDler:D:MODE.....                           | 502 |
| CONTRol:HANDler:D[:DATA].....                         | 501 |
| CONTRol:HANDler:E[:DATA].....                         | 501 |
| CONTRol:HANDler:F[:DATA].....                         | 501 |
| CONTRol:HANDler:G[:DATA].....                         | 501 |
| CONTRol:HANDler:H[:DATA].....                         | 501 |
| CONTRol:HANDler:INPut?.....                           | 503 |
| CONTRol:HANDler:LOGic.....                            | 503 |
| CONTRol:HANDler:OUTPut<Pt>:USER.....                  | 503 |
| CONTRol:HANDler:OUTPut<Pt>[:DATA].....                | 504 |
| CONTRol:HANDler:PASSfail:LOGic.....                   | 504 |
| CONTRol:HANDler:PASSfail:MODE.....                    | 505 |
| CONTRol:HANDler:PASSfail:POLicy.....                  | 505 |
| CONTRol:HANDler:PASSfail:SCOPE.....                   | 506 |
| CONTRol:HANDler:PASSfail:STATus?.....                 | 506 |
| CONTRol:HANDler:RESet.....                            | 507 |

|                                                             |     |
|-------------------------------------------------------------|-----|
| CONTRol:HANDler:SWEEpend.....                               | 507 |
| CONTRol:HANDler[:EXTEnsion]:INDex:STATe.....                | 502 |
| CONTRol:HANDler[:EXTEnsion]:RTRigger:STATe.....             | 502 |
| DIAGnostic:DEVice:STATe.....                                | 508 |
| DIAGnostic:DUMP:SIZE.....                                   | 509 |
| DIAGnostic:PRODuct:OPTion:INFO?.....                        | 508 |
| DIAGnostic:SERVice:FUNCTion.....                            | 752 |
| DIAGnostic:SERVice:RFPower.....                             | 509 |
| DIAGnostic:SERVice:SFUNCTion.....                           | 509 |
| DISPlay:ANNotation:CHANnel[:STATe].....                     | 511 |
| DISPlay:ANNotation:FREQuency[:STATe].....                   | 511 |
| DISPlay:ANNotation:TRACe[:STATe].....                       | 511 |
| DISPlay:CMAp:LIMit:FCOLORize[:STATe].....                   | 512 |
| DISPlay:CMAp:LIMit:FSYMBOL[:STATe].....                     | 512 |
| DISPlay:CMAp:LIMit[:STATe].....                             | 512 |
| DISPlay:CMAp:MARKer[:STATe].....                            | 513 |
| DISPlay:CMAp:TRACe:COLor[:STATe].....                       | 515 |
| DISPlay:CMAp:TRACe:RGB.....                                 | 515 |
| DISPlay:CMAp<DispEl>:RGB.....                               | 513 |
| DISPlay:LAYout.....                                         | 516 |
| DISPlay:LAYout:APPLY.....                                   | 516 |
| DISPlay:LAYout:DEFine.....                                  | 517 |
| DISPlay:LAYout:EXECute.....                                 | 518 |
| DISPlay:LAYout:GRID.....                                    | 518 |
| DISPlay:LAYout:JOIN.....                                    | 519 |
| DISPlay:MENU:KEY:ACTion:CATalog?.....                       | 519 |
| DISPlay:MENU:KEY:EXECute.....                               | 519 |
| DISPlay:MENU:KEY:SELEct.....                                | 520 |
| DISPlay:MENU:KEY:TOOL:CATalog?.....                         | 520 |
| DISPlay:RFSize.....                                         | 520 |
| DISPlay[:WINDow<Wnd>]:CATalog?.....                         | 521 |
| DISPlay[:WINDow<Wnd>]:MAXimize.....                         | 521 |
| DISPlay[:WINDow<Wnd>]:NAME.....                             | 522 |
| DISPlay[:WINDow<Wnd>]:OVERview[:STATe].....                 | 522 |
| DISPlay[:WINDow<Wnd>]:TITLe:DATA.....                       | 523 |
| DISPlay[:WINDow<Wnd>]:TITLe[:STATe].....                    | 523 |
| DISPlay[:WINDow<Wnd>]:TRACe<WndTr>:CATalog?.....            | 524 |
| DISPlay[:WINDow<Wnd>]:TRACe<WndTr>:DELEte.....              | 524 |
| DISPlay[:WINDow<Wnd>]:TRACe<WndTr>:EFEEd.....               | 524 |
| DISPlay[:WINDow<Wnd>]:TRACe<WndTr>:FEED.....                | 525 |
| DISPlay[:WINDow<Wnd>]:TRACe<WndTr>:SHOW.....                | 526 |
| DISPlay[:WINDow<Wnd>]:TRACe<WndTr>:X:OFFSet.....            | 527 |
| DISPlay[:WINDow<Wnd>]:TRACe<WndTr>:Y:OFFSet.....            | 527 |
| DISPlay[:WINDow<Wnd>]:TRACe<WndTr>:Y[:SCALE]:AUTO.....      | 528 |
| DISPlay[:WINDow<Wnd>]:TRACe<WndTr>:Y[:SCALE]:BOTTom.....    | 531 |
| DISPlay[:WINDow<Wnd>]:TRACe<WndTr>:Y[:SCALE]:PDIvision..... | 529 |
| DISPlay[:WINDow<Wnd>]:TRACe<WndTr>:Y[:SCALE]:RLEVel.....    | 529 |
| DISPlay[:WINDow<Wnd>]:TRACe<WndTr>:Y[:SCALE]:RPOsition..... | 530 |
| DISPlay[:WINDow<Wnd>]:TRACe<WndTr>:Y[:SCALE]:TOP.....       | 531 |
| DISPlay[:WINDow<Wnd>]:TRACe<WndTr>:ZOOM:BOTTom.....         | 534 |

|                                                      |     |
|------------------------------------------------------|-----|
| DISPlay[:WINDow<Wnd>]:TRACe<WndTr>:ZOOM:START.....   | 533 |
| DISPlay[:WINDow<Wnd>]:TRACe<WndTr>:ZOOM:STOP.....    | 533 |
| DISPlay[:WINDow<Wnd>]:TRACe<WndTr>:ZOOM:TOP.....     | 534 |
| DISPlay[:WINDow<Wnd>]:TRACe<WndTr>:ZOOM[:STATe]..... | 532 |
| DISPlay[:WINDow<Wnd>][:STATe].....                   | 522 |
| FORMat:BORDER.....                                   | 534 |
| FORMat:DEXPort:SOURce.....                           | 752 |
| FORMat[:DATA].....                                   | 535 |
| HCOPY:DESTination.....                               | 536 |
| HCOPY:DEVice:LANGUage.....                           | 536 |
| HCOPY:ITEM:ALL.....                                  | 537 |
| HCOPY:ITEM:LOGO[:STATe].....                         | 537 |
| HCOPY:ITEM:MLIS[:STATe].....                         | 537 |
| HCOPY:ITEM:TIME[:STATe].....                         | 538 |
| HCOPY:PAGE:COLor.....                                | 538 |
| HCOPY:PAGE:MARGin:BOTTom.....                        | 538 |
| HCOPY:PAGE:MARGin:LEFT.....                          | 539 |
| HCOPY:PAGE:MARGin:RIGHT.....                         | 539 |
| HCOPY:PAGE:MARGin:TOP.....                           | 539 |
| HCOPY:PAGE:ORientation.....                          | 539 |
| HCOPY:PAGE:WINDow.....                               | 540 |
| HCOPY[:IMMEDIATE].....                               | 540 |
| INITiate:CONTinuous:ALL.....                         | 541 |
| INITiate[:IMMEDIATE]:ALL.....                        | 542 |
| INITiate<Ch>:CONTinuous.....                         | 540 |
| INITiate<Ch>[:IMMEDIATE]:SCOPE.....                  | 543 |
| INITiate<Ch>[:IMMEDIATE][:DUMMy].....                | 542 |
| INSTrument:NSElect.....                              | 543 |
| INSTrument:PORT:COUNT?.....                          | 543 |
| INSTrument:TPORT:COUNT?.....                         | 544 |
| INSTrument[:SElect].....                             | 753 |
| MEMory:CATalog:COUNT?.....                           | 544 |
| MEMory:CATalog?.....                                 | 544 |
| MEMory:DEFine.....                                   | 545 |
| MEMory:DELeTe:ALL.....                               | 545 |
| MEMory:DELeTe[:NAME].....                            | 545 |
| MEMory:SElect.....                                   | 545 |
| MMEMory:AKAL:FACTory:CONVersion.....                 | 547 |
| MMEMory:AKAL:USER:CONVersion.....                    | 548 |
| MMEMory:CATalog:ALL?.....                            | 549 |
| MMEMory:CATalog?.....                                | 548 |
| MMEMory:CDIRectory.....                              | 549 |
| MMEMory:CKIT:INFO?.....                              | 550 |
| MMEMory:COpy.....                                    | 550 |
| MMEMory:DATA.....                                    | 551 |
| MMEMory:DELeTe.....                                  | 551 |
| MMEMory:DELeTe:CORRection.....                       | 551 |
| MMEMory:FAVorite<FavId>.....                         | 552 |
| MMEMory:LOAD:CKIT.....                               | 552 |
| MMEMory:LOAD:CKIT:SDATa.....                         | 553 |

|                                                                       |     |
|-----------------------------------------------------------------------|-----|
| MMEMory:LOAD:CKIT:SDATa:WLABel.....                                   | 554 |
| MMEMory:LOAD:CKIT:UDIRectory.....                                     | 555 |
| MMEMory:LOAD:CMAP.....                                                | 555 |
| MMEMory:LOAD:CORRection.....                                          | 556 |
| MMEMory:LOAD:CORRection:MERGe.....                                    | 557 |
| MMEMory:LOAD:CORRection:RESolve.....                                  | 558 |
| MMEMory:LOAD:CORRection:TCoefficient.....                             | 559 |
| MMEMory:LOAD:LIMit.....                                               | 559 |
| MMEMory:LOAD:RIPPlE.....                                              | 561 |
| MMEMory:LOAD:SEGMeNt.....                                             | 562 |
| MMEMory:LOAD:STATe.....                                               | 563 |
| MMEMory:LOAD:TRACe.....                                               | 563 |
| MMEMory:LOAD:TRACe:AUTO.....                                          | 564 |
| MMEMory:MDIRectory.....                                               | 564 |
| MMEMory:MOVE.....                                                     | 565 |
| MMEMory:NAME.....                                                     | 565 |
| MMEMory:RDIRectory.....                                               | 566 |
| MMEMory:STORe:CKIT.....                                               | 566 |
| MMEMory:STORe:CKIT:WLABel.....                                        | 567 |
| MMEMory:STORe:CMAP.....                                               | 567 |
| MMEMory:STORe:CORRection.....                                         | 567 |
| MMEMory:STORe:CORRection:TCoefficient.....                            | 568 |
| MMEMory:STORe:LIMit.....                                              | 568 |
| MMEMory:STORe:MARKer.....                                             | 568 |
| MMEMory:STORe:RIPPlE.....                                             | 569 |
| MMEMory:STORe:SEGMeNt.....                                            | 569 |
| MMEMory:STORe:STATe.....                                              | 570 |
| MMEMory:STORe:TRACe.....                                              | 570 |
| MMEMory:STORe:TRACe:CHANnel.....                                      | 571 |
| MMEMory:STORe:TRACe:OPTion:PLUS.....                                  | 573 |
| MMEMory:STORe:TRACe:OPTion:SSEParator.....                            | 573 |
| MMEMory:STORe:TRACe:OPTion:TABS.....                                  | 573 |
| MMEMory:STORe:TRACe:OPTion:TRIM.....                                  | 574 |
| MMEMory:STORe:TRACe:PORTs.....                                        | 574 |
| OUTPut:UPORt:ECBits.....                                              | 575 |
| OUTPut<Ch>:UPORt[:VALue].....                                         | 576 |
| OUTPut<Ch>[:STATe].....                                               | 575 |
| OUTPut<Chn>:DPORT.....                                                | 753 |
| PROGrama[:SELeCted]:EXECute.....                                      | 578 |
| PROGrama[:SELeCted]:INIMessage.....                                   | 579 |
| PROGrama[:SELeCted]:INIParameter.....                                 | 580 |
| PROGrama[:SELeCted]:NAME.....                                         | 577 |
| PROGrama[:SELeCted]:RETVAl?.....                                      | 579 |
| PROGrama[:SELeCted]:WAIT.....                                         | 579 |
| SOURce:POWer:CORRection:PMETer:ID.....                                | 693 |
| SOURce<Ch>:FREQUency<PhyPt>:CONVersion:ARBitrary:EFREQUency<Gen>..... | 679 |
| SOURce<Ch>:FREQUency<PhyPt>:CONVersion:ARBitrary:IFREQUency.....      | 680 |
| SOURce<Ch>:FREQUency<PhyPt>:FIXed.....                                | 682 |
| SOURce<Ch>:FREQUency<PhyPt>[:CW].....                                 | 682 |
| SOURce<Ch>:GROUp<Grp>.....                                            | 685 |

|                                                                             |     |
|-----------------------------------------------------------------------------|-----|
| SOURce<Ch>:GROup<Grp>:CLEar.....                                            | 686 |
| SOURce<Ch>:GROup<Grp>:PORTs.....                                            | 685 |
| SOURce<Ch>:LPORT<LogPt>.....                                                | 683 |
| SOURce<Ch>:LPORT<LogPt>:CLEar.....                                          | 684 |
| SOURce<Ch>:POWER:CORRection:DATA.....                                       | 691 |
| SOURce<Ch>:POWER:CORRection:DATA:PARAmeter<Wv>?.....                        | 699 |
| SOURce<Ch>:POWER<PhyPt>:CORRection:COLLect:AVERAge:NTOLerance.....          | 689 |
| SOURce<Ch>:POWER<PhyPt>:CORRection:COLLect:AVERAge[:COUNT].....             | 689 |
| SOURce<Ch>:POWER<PhyPt>:CORRection:COLLect:CFActor.....                     | 690 |
| SOURce<Ch>:POWER<PhyPt>:CORRection:COLLect:PMReadings.....                  | 690 |
| SOURce<Ch>:POWER<PhyPt>:CORRection:COLLect[:ACQuire].....                   | 764 |
| SOURce<Ch>:POWER<PhyPt>:CORRection:DATA:PARAmeter<Wv>:COUNT?.....           | 699 |
| SOURce<Ch>:POWER<PhyPt>:CORRection:GENerator<Gen>[:STATe].....              | 691 |
| SOURce<Ch>:POWER<PhyPt>:CORRection:LEVel:OFFSet.....                        | 701 |
| SOURce<Ch>:POWER<PhyPt>:CORRection:NREadings.....                           | 692 |
| SOURce<Ch>:POWER<PhyPt>:CORRection:OSources[:STATe].....                    | 692 |
| SOURce<Ch>:POWER<PhyPt>:CORRection:PPOWER.....                              | 693 |
| SOURce<Ch>:POWER<PhyPt>:CORRection:PSElect.....                             | 693 |
| SOURce<Ch>:POWER<PhyPt>:CORRection:STATe.....                               | 694 |
| SOURce<Ch>:POWER<PhyPt>:CORRection:TCoefficient:CALibration.....            | 694 |
| SOURce<Ch>:POWER<PhyPt>:CORRection:TCoefficient:COUNT?.....                 | 695 |
| SOURce<Ch>:POWER<PhyPt>:CORRection:TCoefficient:DEFine<ListNo>.....         | 696 |
| SOURce<Ch>:POWER<PhyPt>:CORRection:TCoefficient:DELeTe<ListNo>:ALL.....     | 696 |
| SOURce<Ch>:POWER<PhyPt>:CORRection:TCoefficient:DELeTe<ListNo>[:DUMMy]..... | 697 |
| SOURce<Ch>:POWER<PhyPt>:CORRection:TCoefficient:FEED.....                   | 697 |
| SOURce<Ch>:POWER<PhyPt>:CORRection:TCoefficient:INSert<ListNo>.....         | 698 |
| SOURce<Ch>:POWER<PhyPt>:CORRection:TCoefficient[:STATe].....                | 698 |
| SOURce<Ch>:POWER<PhyPt>:CORRection[:ACQuire].....                           | 687 |
| SOURce<Ch>:POWER<PhyPt>:CORRection[:ACQuire]:VERification:RESult?.....      | 688 |
| SOURce<Ch>:POWER<PhyPt>:REDuce:SDELay.....                                  | 704 |
| SOURce<Ch>:POWER<PhyPt>:REDuce[:STATe].....                                 | 703 |
| SOURce<Ch>:POWER<PhyPt>:START.....                                          | 706 |
| SOURce<Ch>:POWER<PhyPt>:STATe.....                                          | 704 |
| SOURce<Ch>:POWER<PhyPt>:STOP.....                                           | 706 |
| SOURce<Ch>:POWER<PhyPt>:SWEepend:MODE.....                                  | 705 |
| SOURce<Ch>:POWER<PhyPt>:SWEepend:SDELay.....                                | 705 |
| SOURce<Ch>:POWER<PhyPt>[:LEVel][:IMMediate]:OFFSet.....                     | 702 |
| SOURce<Ch>:POWER<PhyPt>[:LEVel][:IMMediate]:SLOPe.....                      | 703 |
| SOURce<Ch>:POWER<PhyPt>[:LEVel][:IMMediate][:AMPLitude].....                | 701 |
| STATus:PRESet.....                                                          | 707 |
| STATus:QUEStionable:CONDition?.....                                         | 707 |
| STATus:QUEStionable:ENABLE.....                                             | 708 |
| STATus:QUEStionable:INTegrity:CONDition?.....                               | 707 |
| STATus:QUEStionable:INTegrity:ENABLE.....                                   | 708 |
| STATus:QUEStionable:INTegrity:HARDware:CONDition?.....                      | 707 |
| STATus:QUEStionable:INTegrity:HARDware:ENABLE.....                          | 708 |
| STATus:QUEStionable:INTegrity:HARDware:NTRansition.....                     | 708 |
| STATus:QUEStionable:INTegrity:HARDware:PTRansition.....                     | 709 |
| STATus:QUEStionable:INTegrity:HARDware[:EVENT]?.....                        | 709 |
| STATus:QUEStionable:INTegrity:NTRansition.....                              | 708 |

|                                                                   |     |
|-------------------------------------------------------------------|-----|
| STATus:QUEStionable:INTegrity:PTRansition.....                    | 709 |
| STATus:QUEStionable:INTegrity[:EVENT]?.....                       | 709 |
| STATus:QUEStionable:LIMit<Lev>:CONDition?.....                    | 707 |
| STATus:QUEStionable:LIMit<Lev>:ENABle.....                        | 708 |
| STATus:QUEStionable:LIMit<Lev>:NTRansition.....                   | 708 |
| STATus:QUEStionable:LIMit<Lev>:PTRansition.....                   | 709 |
| STATus:QUEStionable:LIMit<Lev>[:EVENT]?.....                      | 709 |
| STATus:QUEStionable:NTRansition.....                              | 708 |
| STATus:QUEStionable:PTRansition.....                              | 709 |
| STATus:QUEStionable[:EVENT]?.....                                 | 709 |
| STATus:QUEue[:NEXT]?.....                                         | 709 |
| SYSTem:COMMunicate:AKAL:CONNection.....                           | 711 |
| SYSTem:COMMunicate:AKAL:MMEMory[:STATe].....                      | 711 |
| SYSTem:COMMunicate:CODec.....                                     | 711 |
| SYSTem:COMMunicate:GPIB[:SELF]:ADDResS.....                       | 712 |
| SYSTem:COMMunicate:GPIB[:SELF]:INIT:WAIT.....                     | 712 |
| SYSTem:COMMunicate:GPIB[:SELF]:LPORT:ALIGn.....                   | 712 |
| SYSTem:COMMunicate:GPIB[:SELF]:RTERminator.....                   | 713 |
| SYSTem:COMMunicate:RDEvice:AKAL:ADDResS.....                      | 713 |
| SYSTem:COMMunicate:RDEvice:AKAL:ADDResS:ALL?.....                 | 713 |
| SYSTem:COMMunicate:RDEvice:AKAL:CKIT:CATalog?.....                | 714 |
| SYSTem:COMMunicate:RDEvice:AKAL:CKIT:STANDard:CATalog?.....       | 715 |
| SYSTem:COMMunicate:RDEvice:AKAL:DATE?.....                        | 715 |
| SYSTem:COMMunicate:RDEvice:AKAL:FRANge?.....                      | 715 |
| SYSTem:COMMunicate:RDEvice:AKAL:PORTs?.....                       | 716 |
| SYSTem:COMMunicate:RDEvice:AKAL:PREdUction[:STATe].....           | 716 |
| SYSTem:COMMunicate:RDEvice:AKAL:SDATa?.....                       | 717 |
| SYSTem:COMMunicate:RDEvice:AKAL:WARMup[:STATe]?.....              | 718 |
| SYSTem:COMMunicate:RDEvice:PMETer:CONFigure:AUTO[:STATe].....     | 719 |
| SYSTem:COMMunicate:RDEvice:PMETer:COUNT?.....                     | 719 |
| SYSTem:COMMunicate:RDEvice:PMETer:DELeTe.....                     | 718 |
| SYSTem:COMMunicate:RDEvice:PMETer<Pmtr>:AZERo.....                | 718 |
| SYSTem:COMMunicate:RDEvice:PMETer<Pmtr>:CATalog?.....             | 718 |
| SYSTem:COMMunicate:RDEvice:PMETer<Pmtr>:DEFine.....               | 719 |
| SYSTem:COMMunicate:RDEvice:PMETer<Pmtr>:SPCorrECTION[:STATe]..... | 720 |
| SYSTem:CORREction:WIZard[:IMMEDIATE].....                         | 722 |
| SYSTem:DATE.....                                                  | 722 |
| SYSTem:DFPRint?.....                                              | 722 |
| SYSTem:DISPlay:BAR:HKEY[:STATe].....                              | 722 |
| SYSTem:DISPlay:BAR:MENU[:STATe].....                              | 722 |
| SYSTem:DISPlay:BAR:STATus[:STATe].....                            | 722 |
| SYSTem:DISPlay:BAR:STOols[:STATe].....                            | 722 |
| SYSTem:DISPlay:BAR:TITLe[:STATe].....                             | 723 |
| SYSTem:DISPlay:BAR:TOOLs[:STATe].....                             | 723 |
| SYSTem:DISPlay:COLor.....                                         | 723 |
| SYSTem:DISPlay:DIALogs:SETup:MCAL[:STATe].....                    | 734 |
| SYSTem:DISPlay:UPDate.....                                        | 723 |
| SYSTem:ERRor:ALL?.....                                            | 724 |
| SYSTem:ERRor:DISPlay:ERRor.....                                   | 724 |
| SYSTem:ERRor:DISPlay:INFO.....                                    | 724 |



|                                                 |     |
|-------------------------------------------------|-----|
| SYSTem:ERRor:DISPlay:STATe.....                 | 724 |
| SYSTem:ERRor:DISPlay:WARNings.....              | 724 |
| SYSTem:ERRor:DISPlay[:REMote].....              | 725 |
| SYSTem:ERRor[:NEXT]?.....                       | 725 |
| SYSTem:FIRMware:UPDate.....                     | 726 |
| SYSTem:FPReset.....                             | 726 |
| SYSTem:FREQuency?.....                          | 726 |
| SYSTem:IDENtify:FACTory.....                    | 727 |
| SYSTem:IDENtify[:STRing].....                   | 727 |
| SYSTem:KLOCK.....                               | 727 |
| SYSTem:LANGuage.....                            | 727 |
| SYSTem:LOGGing:REMote[:STATe].....              | 728 |
| SYSTem:OPTions:FACTory.....                     | 728 |
| SYSTem:OPTions[:STRing].....                    | 728 |
| SYSTem:PASSword[:CENable].....                  | 729 |
| SYSTem:PRESet:REMote[:STATe].....               | 729 |
| SYSTem:PRESet:SCOPE.....                        | 729 |
| SYSTem:PRESet:USER:CAL.....                     | 730 |
| SYSTem:PRESet:USER:NAME.....                    | 730 |
| SYSTem:PRESet:USER[:STATe].....                 | 730 |
| SYSTem:PRESet[:DUMMy].....                      | 731 |
| SYSTem:SETTings:UPDate.....                     | 731 |
| SYSTem:SHUTdown.....                            | 732 |
| SYSTem:SMATrix:OPTimization.....                | 734 |
| SYSTem:SOUNd:ALARm[:STATe].....                 | 732 |
| SYSTem:SOUNd:STATus[:STATe].....                | 732 |
| SYSTem:TIME.....                                | 733 |
| SYSTem:TSLock.....                              | 733 |
| SYSTem:USER:KEY.....                            | 733 |
| SYSTem:VERSion?.....                            | 734 |
| TRACe:CLEar.....                                | 765 |
| TRACe:COPY.....                                 | 735 |
| TRACe:COPY:MATH.....                            | 736 |
| TRACe[:DATA]:STIMulus[:ALL]?.....               | 766 |
| TRACe[:DATA][:RESPonse][:ALL]?.....             | 765 |
| TRIGger:CHANnel<Ch>:AUXiliary<n>:DURation.....  | 742 |
| TRIGger:CHANnel<Ch>:AUXiliary<n>:INTerval.....  | 743 |
| TRIGger:CHANnel<Ch>:AUXiliary<n>:OPOLarity..... | 743 |
| TRIGger:CHANnel<Ch>:AUXiliary<n>:POSition.....  | 744 |
| TRIGger:CHANnel<Ch>:AUXiliary<n>[:ENABLE].....  | 742 |
| TRIGger<Ch>[:SEQUence]:HOLDoff.....             | 738 |
| TRIGger<Ch>[:SEQUence]:LINK.....                | 738 |
| TRIGger<Ch>[:SEQUence]:MULTiple:HOLDoff.....    | 739 |
| TRIGger<Ch>[:SEQUence]:MULTiple:SLOPe<Num>..... | 739 |
| TRIGger<Ch>[:SEQUence]:MULTiple:SOURce.....     | 740 |
| TRIGger<Ch>[:SEQUence]:SLOPe.....               | 741 |
| TRIGger<Ch>[:SEQUence]:SOURce.....              | 741 |

# Index

## Symbols

|                            |          |
|----------------------------|----------|
| @DCL .....                 | 805      |
| @GET .....                 | 805      |
| @LOC .....                 | 805      |
| @REM .....                 | 805      |
| *.csv file format .....    | 71       |
| *.limit .....              | 67       |
| *.ripple .....             | 68       |
| *.s<n>p file format .....  | 69       |
| *CLS .....                 | 392, 400 |
| *ESE .....                 | 400      |
| *ESR? .....                | 400      |
| *IDN? .....                | 400      |
| *IST? .....                | 400      |
| *OPC .....                 | 400      |
| *OPC (use) .....           | 389      |
| *OPT? .....                | 401      |
| *PCB .....                 | 401      |
| *PRE .....                 | 401      |
| *PSC .....                 | 401      |
| *RST .....                 | 401      |
| *SRE .....                 | 401      |
| *STB? .....                | 401      |
| *TRG .....                 | 401      |
| *WAI .....                 | 401      |
| <Channel> Properties ..... | 296      |
| µ1 21 (softkey) .....      | 148      |
| µ2 21 (softkey) .....      | 148      |

## A

|                                                 |          |
|-------------------------------------------------|----------|
| a1 Source Port 1 .....                          | 139      |
| a2 Source Port 2 .....                          | 139      |
| About .....                                     | 357      |
| Active Channel (softkey) .....                  | 163, 297 |
| Active Diagram .....                            | 320      |
| Active Diagram (softkey) .....                  | 163      |
| Active Power Cals (dialog) .....                | 293      |
| Active Trace (softkey) .....                    | 163      |
| Add Ch + Tr + Dia .....                         | 298      |
| Add Ch + Trace .....                            | 297      |
| Add Device .....                                |          |
| external power meters .....                     | 353      |
| Add Ref Impedances .....                        | 192      |
| Add Tr+Diag .....                               | 320      |
| Add Trace .....                                 | 163      |
| Add Trace + Diag .....                          | 164      |
| Additional Removable HD (R&S ZNC/ZND-B19) ..... | 116      |
| Addressed command .....                         | 365, 807 |
| Adjust Time Gate .....                          | 313      |
| Admittance .....                                | 52       |
| AGC manual configuration .....                  | 303      |
| AGC Mode .....                                  | 302      |
| AGC sweep segments .....                        | 304      |
| All Data & Func to Mem .....                    | 174      |
| All Data to Mem .....                           | 174      |
| All Markers Off .....                           | 212      |
| All Power Cals On / Off .....                   | 293      |
| All S-Params .....                              | 129      |
| Alternated (driving mode) .....                 | 300      |
| Annexes .....                                   | 803      |
| Aperture .....                                  | 62, 187  |

|                                                  |          |
|--------------------------------------------------|----------|
| Aperture (softkey) .....                         | 153      |
| Applic Menu .....                                | 355      |
| Apply .....                                      |          |
| System Error Correction .....                    | 267      |
| Apply (calibration) .....                        | 270      |
| ASCII .....                                      | 333      |
| ASCII (*.csv) file .....                         | 71       |
| Ask before Overwriting .....                     | 192      |
| ATN .....                                        | 806      |
| Attention .....                                  | 806      |
| Authentication (cal unit characterization) ..... | 282      |
| Auto Config NRP-Zxx .....                        | 354      |
| Auto Length .....                                | 314      |
| Auto Length and Loss .....                       | 319      |
| Auto Power Reduction for Cal Unit .....          | 335      |
| Auto Scale Diagram .....                         | 158      |
| Auto Scale Trace .....                           | 158      |
| Auto Zero .....                                  | 150, 287 |
| Automatic calibration .....                      | 91       |
| Axis Pair .....                                  | 180      |

## B

|                                     |     |
|-------------------------------------|-----|
| b1 / a1 Source Port 1 .....         | 136 |
| b1 / a2 Source Port 2 .....         | 136 |
| b1 Source Port 1 .....              | 139 |
| b1 Source Port 2 .....              | 139 |
| b2 / a1 Source Port 1 .....         | 136 |
| b2 / a2 Source Port 2 .....         | 136 |
| b2 Source Port 1 .....              | 139 |
| b2 Source Port 2 .....              | 139 |
| Balanced port .....                 | 58  |
| Balanced Ports (dialog) .....       | 132 |
| Band pass impulse .....             | 111 |
| Bandfilter search .....             | 34  |
| Bandpass .....                      | 34  |
| Bandpass (time gate) .....          | 181 |
| Bandpass Ref to Max .....           | 223 |
| Bandpass Ref to Mkr .....           | 224 |
| Bandstop .....                      | 34  |
| Bandstop Ref to Max .....           | 224 |
| Bandwidth .....                     | 234 |
| Bandwidth (bandfilter search) ..... | 223 |
| Bandwidth (bandfilter) .....        | 34  |
| Basic instrument concepts .....     | 11  |
| Black White Scheme .....            | 330 |
| Block data format .....             | 369 |
| Boolean parameter .....             | 369 |
| Buffered Sweep .....                | 790 |

## C

|                                     |     |
|-------------------------------------|-----|
| Cal Connector Types (dialog) .....  | 273 |
| Cal group .....                     | 91  |
| Cal Kit .....                       |     |
| Import .....                        | 265 |
| Selection .....                     | 265 |
| Cal kit file .....                  | 89  |
| Cal Kits .....                      |     |
| Calibration Presetting Wizard ..... | 263 |
| Cal Power Offset .....              | 289 |

- Cal Unit
    - Characterization ..... 256
    - SMARTerCal ..... 255
  - Calibrate all Channels ..... 257, 263
  - Calibration ..... 73, 252, 792
    - Cal Devices ..... 273
    - manual ..... 260
    - Ports ..... 255, 262
    - Ports and Standards ..... 266
    - program example ..... 792
    - Pwr Cal Settings ..... 286
    - same connector all ports ..... 265
    - same gender all ports ..... 265
    - Source port ..... 263
    - Start Cal ..... 252
    - Sweep Diagrams ..... 259, 266
    - Type ..... 263
    - Use Cal ..... 292
  - Calibration (System Configuration) ..... 334
  - Calibration kit ..... 85
  - Calibration Kits (dialog) ..... 276
  - Calibration labels
    - scalar power calibration ..... 100
    - system error correction ..... 91
  - Calibration Manager (dialog) ..... 294
  - Calibration pool ..... 91
  - Calibration Presetting Wizard ..... 260
    - Calibration ..... 265
    - Connectors and Cal Kits ..... 263
  - Calibration standard ..... 85
  - Calibration sweep diagram
    - power calibration ..... 269
  - Calibration types ..... 74
  - Calibration unit ..... 91
  - Calibration Unit ..... 282
    - Detect Port Assignment ..... 258, 260
    - Detect Ports & Start Cal ..... 259
  - Calibration Unit Wizard ..... 253
  - Cartesian diagram ..... 40
  - CD-ROM ..... 9
  - CENTER ..... 17
  - Center (bandfilter) ..... 34
  - Center = Marker ..... 215, 226
  - Center Frequency ..... 229
  - Channel ..... 12
    - programming examples ..... 770
  - Channel Bits ..... 338
  - Channel Bits (System Configuration) ..... 338
  - Channel Config ..... 296
    - Channels ..... 296
    - Mode ..... 300
    - Pwr Cal Settings ..... 304
  - Channel Info ..... 327
  - Channel Manager dialog ..... 299
  - Channel settings ..... 35, 233
  - Channel State ..... 295
  - Characteristic impedance ..... 274
  - Characterization
    - Cal Unit ..... 256
  - Characterization Data ..... 282
  - Characterization wizard ..... 283
  - Characterize Cal Unit (dialog) ..... 281
  - Chirp z-transformation ..... 110
  - Chopped (driving mode) ..... 300
  - Circle limit ..... 66
  - Circle Test ..... 205
  - Clear Test
    - Circle ..... 208
    - Limit Line ..... 197
    - Ripple ..... 203
  - Close ..... 358
  - Color Scheme ..... 326
  - Colorize Trace when Failed ..... 329
  - Command ..... 365
    - common ..... 365
    - device-specific ..... 375
    - processing ..... 375
    - recognition ..... 375
    - sequence ..... 375
    - structure and syntax ..... 365
    - synchronization ..... 375
  - Command reference ..... 401
  - Common commands ..... 398, 400
  - Common mode ..... 57, 58
  - Common Mode / Differential Mode ..... 135
  - Compr Point ..... 184
  - Compr Value ..... 184
  - CONDition ..... 380, 381
  - Configured devices
    - external power meters ..... 352
  - Connectors ..... 803
    - Calibration Presetting Wizard ..... 263
  - Contents (help) ..... 357
  - Contents (trace export) ..... 192
  - Context menu ..... 36
  - Continuous sweep ..... 249
  - Control bus ..... 806
  - Control elements ..... 20
  - Control lines (GPIB bus) ..... 805
  - Control menu ..... 357
  - Convergence (flatness cal) ..... 287
  - Couple Active Trace ..... 160
  - Couple All Traces ..... 160
  - Coupled Markers ..... 212
  - Cutoff Frequency ..... 275
  - CW Frequency ..... 230
  - CW Mode ..... 242
- D**
- Data & Func to <Destination> ..... 168
  - Data base ..... 375
  - Data bus (GPIB) ..... 805
  - Data flow ..... 18
  - Data to <Destination> ..... 168
  - Data Valid ..... 806
  - DAV ..... 806
  - dB Mag (softkey) ..... 151
  - DC Inputs ..... 803
  - DC Value ..... 178
  - DCL ..... 805, 807
  - DCL,SDC ..... 392
  - Decimal Separator ..... 193
  - Decouple Active Trace ..... 160
  - Decouple All Traces ..... 160
  - DEFault ..... 369
  - Default file locations ..... 546
  - Default Port Assignment ..... 258
  - Define \*IDN? + \*OPT? ..... 347
  - Define Limit Lines (dialog) ..... 198
  - Define Math ..... 170
  - Define Ripple Test (dialog) ..... 203
  - Define Segments (dialog) ..... 244

- Define User Color Scheme (dialog) ..... 328
  - Delay ..... 62, 280
  - Delay (Offset Embed) ..... 312, 313
  - Delay (softkey) ..... 152
  - Delay (trigger) ..... 307
  - Delete All Cal Kits ..... 335
  - Delete all Mem ..... 175
  - Delete Cal Pool ..... 335
  - Delete Channel ..... 298
  - Delete Diagram ..... 321
  - Delete Trace ..... 164
  - Delta Mode ..... 211
  - Denominator ..... 138
  - Destination ..... 174
  - Destination (memory trace) ..... 167
  - Detector ..... 56
  - Device address ..... 364
  - Device message ..... 365
  - Device response ..... 365
  - Diagram ..... 12
    - programming examples ..... 770
  - Dialog ..... 36
  - Differential mode ..... 57, 58
  - Discrete ..... 213
  - Display
    - Config ..... 325
    - Diagram ..... 319
    - Split ..... 323
    - TouchScreen ..... 331
    - View Bar ..... 330
  - Display elements ..... 25
  - Display formats ..... 39
  - Display Remote Errors ..... 338
  - Display settings ..... 319
  - Displayed Columns (dialog) ..... 247
  - Documentation map ..... 9
  - DOWN ..... 369
  - Driver (remote control) ..... 360
  - Driving Mode ..... 300
  - Dual Split ..... 324
- E**
- Electrical Length ..... 62, 312, 313
  - Electrical Length (calibration standard) ..... 280
  - ENABLE ..... 379, 380
  - EOI ..... 806
  - Error Log ..... 344
  - Error message ..... 798
  - Error queue ..... 379, 391
  - Errors ..... 798
    - Asynchronous ..... 799
    - During firmware update ..... 801
    - During measurement ..... 799
    - FPGA update ..... 801
  - ESB ..... 383
  - ESE ..... 379, 384
  - ESR ..... 384
  - Evaluation Range (dialog) ..... 186
  - EVENT register ..... 380
  - Execution (command)
    - overlapping ..... 375
    - sequential ..... 375
  - Export
    - sweep segments ..... 246
  - Export (trace data) ..... 190
  - Export Data (dialog) ..... 191
  - Export Markers ..... 214
  - Ext Frequency ..... 346
  - EXT TRIG OUT / IN ..... 804
  - Extended Power Range (R&S ZNC3-B22) ..... 117
  - Extended Power Range (R&S ZND-K7) ..... 117
  - External power meter ..... 117
  - External Power Meters (dialog) ..... 351
  - External reference ..... 345
- F**
- Factor (average) ..... 235
  - Favorites ..... 122
  - Field Separator ..... 193
  - File settings ..... 120
  - Fixed (marker) ..... 214
  - Fixture Compensation ..... 314
  - Flatness / Gain / Slope ..... 184
  - Flatness calibration ..... 98
  - Flatten Noise ..... 236
  - Font Size ..... 328
  - Format settings ..... 150
  - Formatted Values (trace export) ..... 193
  - FPGA update failure ..... 801
  - Free Run / External / Manual / Multiple Triggers ..... 305
  - Freq for Loss ..... 318
  - Freq Step Size ..... 237
  - Frequency Resolution 1 mHz (R&S ZNC/ZND-K19) ..... 116
  - Frequency Span ..... 229
  - Fuse replacement ..... 816
- G**
- GET ..... 805, 807
  - Getting started guide ..... 9
  - Global Check ..... 197
  - Global settings ..... 11
  - Global Settings ..... 334
  - GPIB
    - introduction ..... 359
  - GPIB Address ..... 346
  - GPIB bus interface ..... 805
  - GPIB bus messages ..... 365
  - GPIB Explorer ..... 356, 360
  - GPIB Interface
    - R&S ZNC-B10 ..... 116
    - R&S ZND-B10 ..... 116
  - GTL ..... 807
- H**
- Handler I/O (R&S ZN-B14) ..... 116
  - Handler I/O (Universal Interface) ..... 808
  - Handshake bus ..... 805
  - Hardkey panel ..... 24
  - Hardware ..... 343
  - Hardware (connectors) ..... 803
  - Harmonic grid ..... 112, 178
  - Help Menu ..... 357
  - Help system ..... 9
  - Hide All Data ..... 175
  - Hide All Mem ..... 175
  - HiSLIP ..... 359
  - Hold ..... 188
  - Horizontal Line ..... 210

**I**

|                                    |               |
|------------------------------------|---------------|
| Ideal (cal kit) .....              | 87            |
| IEC/IEEE Bus Interface .....       | 805           |
| IECWIN32 .....                     | 360           |
| IEEE 488 CH 1 .....                | 805           |
| IEEE 488 CH 2 .....                | 805           |
| IFC .....                          | 806, 807      |
| Imag (softkey) .....               | 156           |
| Image Suppr. ....                  | 301           |
| Impedance .....                    | 49            |
| Import                             |               |
| Cal Kit .....                      | 265           |
| sweep segments .....               | 246           |
| Import (trace data) .....          | 190           |
| Import Complex Data (dialog) ..... | 190           |
| Import Data to New Mem .....       | 191           |
| Import File .....                  | 200           |
| Import Trace .....                 | 200           |
| Impulse Response .....             | 176           |
| Index (help) .....                 | 357           |
| INFintiy .....                     | 369           |
| Info (dialog) .....                | 342           |
| Info Table .....                   | 327           |
| Instrument hardware .....          | 375           |
| Instrument Messages .....          | 336, 348, 808 |
| Instrument-control commands .....  | 365           |
| Interface                          |               |
| functions (GPIB bus) .....         | 807           |
| Interface Clear .....              | 806           |
| Interface message .....            | 365           |
| Interface messages                 |               |
| GPIB .....                         | 807           |
| VXI-11 .....                       | 805           |
| Interfaces .....                   | 803           |
| Internal reference .....           | 345           |
| Inv Smith (softkey) .....          | 156           |
| Inverted Smith chart .....         | 45            |
| IP Address .....                   | 346           |
| IST flag .....                     | 379, 384      |

**K**

|                              |     |
|------------------------------|-----|
| K 21 (softkey) .....         | 148 |
| Keyword (SCPI command) ..... | 365 |
| Kit Standards (dialog) ..... | 277 |
| Known devices                |     |
| external power meters .....  | 352 |

**L**

|                             |          |
|-----------------------------|----------|
| LAN Config Initialize ..... | 349      |
| LAN Detection               |          |
| external power meters ..... | 353      |
| Language .....              | 332      |
| Light Scheme .....          | 330      |
| Limit Check (softkey) ..... | 196      |
| Limit Fail Beep .....       | 197      |
| Limit line .....            | 63       |
| files .....                 | 67       |
| Lin Freq .....              | 239, 240 |
| Lin Mag (softkey) .....     | 155      |
| Line Styles Scheme .....    | 330      |
| Line Type .....             | 275      |
| Lines                       |          |
| Display Circle .....        | 208      |
| Horizontal Line .....       | 209      |

|                                              |     |
|----------------------------------------------|-----|
| Limit Test .....                             | 194 |
| Ripple Test .....                            | 201 |
| Lines settings .....                         | 194 |
| LLO .....                                    | 807 |
| Load parameters (calibration standard) ..... | 280 |
| LOC .....                                    | 805 |
| Lock Diagrams .....                          | 331 |
| Lock Screen .....                            | 331 |
| Log Errors .....                             | 351 |
| Loss .....                                   | 280 |
| Loss (bandfilter) .....                      | 34  |
| Loss at DC .....                             | 318 |
| Loss at Freq .....                           | 318 |
| Loss parameters                              |     |
| definition .....                             | 104 |
| Low Distortion .....                         | 302 |
| Low Noise .....                              | 302 |
| Low pass impulse .....                       | 111 |
| Low Pass Settings (dialog) .....             | 177 |
| Low pass step .....                          | 111 |
| Lower edge (bandfilter) .....                | 34  |
| Lower limit .....                            | 63  |
| LXI                                          |     |
| browser interface .....                      | 393 |
| classes .....                                | 392 |
| configuration .....                          | 392 |
| LXI Status Enabled .....                     | 349 |

**M**

|                                  |     |
|----------------------------------|-----|
| Maintenance .....                | 816 |
| Manual Config... (AGC) .....     | 303 |
| Manual Trigger .....             | 307 |
| Marker .....                     | 29  |
| Bandfilter Search .....          | 222 |
| Info Field .....                 | 227 |
| Marker Props .....               | 212 |
| Marker Search .....              | 214 |
| Markers .....                    | 210 |
| Set by Marker .....              | 226 |
| Target Search .....              | 219 |
| Marker coupling .....            | 32  |
| Marker Format .....              | 213 |
| Marker Info .....                | 214 |
| Marker info field .....          | 30  |
| Marker Name .....                | 213 |
| Marker search functions .....    | 33  |
| Marker settings .....            | 210 |
| Marker Style .....               | 213 |
| Max (marker search) .....        | 215 |
| Max (multiple peak search) ..... | 219 |
| Max (softkey, trace scale) ..... | 159 |
| Max = Marker .....               | 227 |
| Max Hold .....                   | 188 |
| Maximize .....                   | 358 |
| MAXimum .....                    | 369 |
| Mean/Std Dev / RMS .....         | 182 |
| Meas                             |     |
| Admittance .....                 | 144 |
| Impedance .....                  | 142 |
| Power Sensor .....               | 149 |
| Ratios .....                     | 136 |
| S-params .....                   | 127 |
| Stability .....                  | 148 |
| Wave .....                       | 139 |
| Y-Z-Params .....                 | 146 |
| Meas Delay .....                 | 238 |

- Meas settings ..... 126  
 Measure Fixture ..... 315  
 Measure Fixture Terminated Type ..... 314  
 Measurement receiver calibration ..... 99  
 Measurement results ..... 48  
 Mechanical Length ..... 312, 313  
 Menu bar ..... 22  
 Menus ..... 23  
 Messages (System Configuration) ..... 337  
 Min (marker search) ..... 215  
 Min (multiple peak search) ..... 219  
 Min (softkey, trace scale) ..... 159  
 Min = Marker ..... 227  
 Min Hold ..... 188  
 Min/Max Peak-Peak ..... 182  
 Minimize ..... 358  
 MINimum ..... 369  
 Mixed mode parameters ..... 58  
 Mkr 1 ... Mkr 10 ..... 211  
 Mkr Stimulus ..... 211  
 Mode conversion factor ..... 58  
 Modify Cal Power (dialog) ..... 288  
 More Ratios ..... 137  
 More Ratios (dialog) ..... 137  
 More Wave Quantities ..... 140  
 More Wave Quantities (dialog) ..... 141  
 Move ..... 357
- N**
- NAN (not a number) ..... 369  
 Navigation tools ..... 20  
 NDAC ..... 806  
 New (recall set) ..... 121  
 Next Peak ..... 216  
 NINF (negative infinity) ..... 369  
 Notch (time gate) ..... 181  
 NRFD ..... 806  
 NTR ..... 379  
 NTRansition ..... 380, 382  
 Number of Points ..... 237  
 Numerator ..... 138  
 Numeric Suffix (remote control) ..... 399
- O**
- Offset Correction ..... 314  
 Offset Embed ..... 309  
   De-/Activate ..... 310  
   Impedance Renormalization ..... 311  
   Offset ..... 310, 311  
   One Way Loss ..... 317  
   Reset Offsets ..... 310  
 Offset Loss ..... 280  
 Offset model ..... 275  
 Offset parameters ..... 103  
   application ..... 108  
   balanced ports ..... 108  
   definition ..... 103  
 Offset parameters (calibration standard) ..... 280  
 Open Recall ..... 122  
 Operation Complete ..... 384  
 OPERation register ..... 379, 385  
 Options ..... 343  
   R&S ZN-B14 ..... 808  
   R&S ZNC/ZND-K2 ..... 175  
   R&S ZVAB-B44 ..... 351  
   Options (overview) ..... 109  
   Output Format (trace export) ..... 192  
   Output unit ..... 375  
   Overlapped command execution ..... 375  
   Overlay All ..... 321  
   Overview Select ..... 161
- P**
- Packing ..... 816  
 Parallel Poll ..... 390  
 Parameter (remote control) ..... 399  
 Partial measurement ..... 15  
 Password ..... 345  
   cal unit characterization ..... 282  
 Peak Left / Right ..... 216  
 Peak Type ..... 216, 276, 277, 279  
 Permittivity ..... 313  
 Persistent settings ..... 11  
 Phase (softkey) ..... 151  
 Phase / EI Length ..... 183  
 Pin 16 - 19 ..... 339  
 Polar (softkey) ..... 152  
 Polar diagram ..... 41  
 Port  
   Connector ..... 264  
   Gender ..... 264  
   Offset ..... 312  
 Port (Offset Embed) ..... 318  
 Port Power Offset ..... 289  
 Ports  
   Calibration ..... 255, 262  
   Power ..... 230  
   Power (sweep) ..... 241  
   Power Bandwidth Average settings ..... 233  
   Power Bw Avg  
     Average ..... 234  
     Bandwidth ..... 233  
     Power ..... 233  
 Power Cal  
   Screen ..... 268  
 Power Cal – Meas. Receiver (dialog) ..... 271  
 Power Cal – Power (dialog) ..... 270  
 Power calibration ..... 97  
   measurement receiver ..... 99  
   reference receiver ..... 98  
   source ..... 98  
 Power loss list ..... 291  
 Power meter (external) ..... 117  
 Power Meter Transmission Coefficients (dialog) ..... 290  
 Power Sensor (menu) ..... 149  
 PPC ..... 807  
 PPE ..... 379, 384  
 PPU ..... 807  
 Predefined Configs  
   Balanced ports ..... 132  
 Prefix  
   Units ..... 337  
 Preset ..... 392  
 Preset Configuration ..... 334  
 Preset Scope ..... 334  
 Presets (System Configuration) ..... 334  
 Print ..... 123  
 Program example ..... 792  
   calibration ..... 792  
 Programming examples ..... 767  
 PTR ..... 381

- PTRansition ..... 380  
Public folder ..... 546
- Q**
- Quad Split ..... 324  
Quality factor (bandfilter) ..... 34  
Query ..... 365  
QUESTionable register ..... 379, 385  
    Summary bit ..... 383  
QUESTionable:INTegrity register ..... 387  
QUESTionable:LIMit register ..... 386
- R**
- R&S ZN-B14 (Handler I/O) ..... 116, 808  
R&S ZNC-B10 (GPIB Interface) ..... 116  
R&S ZNC-K2 (option) ..... 175, 179  
R&S ZNC/ZND-K2 (Time domain analysis) ..... 110  
R&S ZNC/ZND-K19 (Frequency Resolution 1 mHz) ..... 116  
R&S ZNC3-B22 (Extended Power Range) ..... 117  
R&S ZND-B10 (GPIB Interface) ..... 116  
R&S ZND-K2 (option) ..... 175, 179  
R&S ZND-K7 (Extended Power Range) ..... 117  
R&S ZV-Zxx ..... 91  
R&S ZVAB-B44 (option) ..... 351  
R&S ZVR compatible commands ..... 744  
Range Limit Lines on  
    Evaluation Range ..... 186  
    Search Range ..... 218  
Ratio ..... 55  
Ratios (menu) ..... 136  
Read .s1p File ..... 279  
Read .s2p File ..... 279  
Read-only folder ..... 546  
Real (softkey) ..... 156  
Recall Last Cal Set ..... 293  
Recall Limit Line ..... 200  
Recall Ripple Test ..... 205  
Recall set ..... 12  
Recall Sets ..... 120  
Recent Files ..... 122  
Reduce Noise ..... 236  
Ref Mkr ..... 212  
Ref Mkr -> Mkr ..... 214  
Ref Position ..... 159  
Ref Val = Marker ..... 227  
Ref Value ..... 159  
Reference impedance ..... 60  
Reference Impedance  
    Balanced ports ..... 134  
Reference Receiver Cal Power ..... 289  
Relative Permittivity ..... 275  
Release notes ..... 10  
REM ..... 805  
Remote control ..... 359, 776  
    activation ..... 362  
    basic concepts ..... 371  
    introduction ..... 359  
Remote Control  
    Codec ..... 333  
    combine with manual control ..... 364  
Remote Language ..... 346  
Remote LXI (dialog) ..... 348  
Remote Preset Configuration ..... 334  
Removable HD (R&S ZNC/ZND-B19) ..... 116  
REN ..... 806
- Renormalization (of port impedances) ..... 60  
Renormalization according to Theory of ..... 136  
Replacing fuses ..... 816  
Reset Colors ..... 337  
Reset Dialogs ..... 337  
Reset Values  
    Status Reporting System ..... 392  
Resolution Enh(ancement) ..... 177  
Resolve Pool Link ..... 296  
Response (to queries) ..... 365  
Response Value (horizontal line) ..... 210  
Restart Manager (dialog) ..... 251  
Restart Sweep ..... 250  
Restart Sweep on Std Meas ..... 267  
Restore ..... 357  
Result is Wave Quantity ..... 172  
Result Off ..... 225  
Revision ..... 10  
RF Off All Channels ..... 231  
Ripple Check (softkey) ..... 202  
Ripple Fail Beep ..... 203  
Ripple limit ..... 63  
    files ..... 68
- S**
- S-parameter ..... 48  
S-Parameter (softkey) ..... 128  
S-Parameter Wizard ..... 129  
S<out><in> (softkeys) ..... 128  
S11 (softkey) ..... 128  
S21 (softkey) ..... 128  
Same Color all Markers ..... 330  
Save (recall set) ..... 122  
Save Limit Line ..... 200  
Save Ripple Test ..... 205  
Scalar power calibration ..... 97  
Scale  
    Scale Coupling ..... 160  
    Scale Values ..... 157  
    Zooming ..... 161  
Scale settings ..... 157  
Scale/Div ..... 159  
Scan Instruments  
    external power meters ..... 353  
SCPI command structure ..... 365  
SCPI commands ..... 365  
SCPI Status Register ..... 380  
    event status register ..... 384  
    IST flag ..... 384  
    parallel poll enable register ..... 384  
    service request enable register ..... 383  
    status byte ..... 383  
    STATus:OPERation register ..... 385  
    STATus:QUESTionable register ..... 385  
    STATus:QUESTionable:INTegrity ..... 387  
    STATus:QUESTionable:LIMit ..... 386  
    Structure ..... 379  
Screen elements ..... 20  
Screen Keyboard ..... 356  
SDC ..... 807  
Search functions ..... 33  
Search Left (target) ..... 221  
Search Mode ..... 216, 225  
Search Path for Additional Cal Kits... ..... 335  
Search Range (dialog) ..... 217  
Search Right (target) ..... 221

- Seg x-Axis ..... 243
  - Segmented (sweep) ..... 240
  - Segmented AGC ..... 304
  - Select Marker ..... 217
  - Select Parameters (dialog) ..... 194
  - Selftest ..... 344
  - Sequence (trigger) ..... 306
  - Sequential command execution ..... 375
  - Serial Poll ..... 390
  - Service Function (dialog) ..... 344
  - Service request ..... 389
  - Service Request Enable ..... 379, 383
  - Setup
    - External Devices ..... 350
    - Reference ..... 345
    - Remote Settings ..... 346, 355
    - Setup ..... 332
  - Setup (Info) ..... 342
  - Shift JIS ..... 333
  - Shift trace
    - response ..... 188
    - stimulus ..... 188
  - Show <Data> ..... 169
  - Show All Data ..... 175
  - Show All Mem ..... 175
  - Show as ..... 142
  - Show Limit Fail Symbols ..... 329
  - Show Limit Line ..... 195
  - Show Mem ..... 169
  - Show Point List ..... 246
  - Show Range Limits ..... 180
  - Show Results All Traces ..... 203
  - Show Ripple Limits ..... 202
  - Show Sweep Symbols ..... 336
  - Side Lobe Level
    - frequency window ..... 177
    - time gate ..... 181
  - Single sweep ..... 249
  - Single-ended mode ..... 57, 58
  - Size ..... 358
  - Sliding Match ..... 88
  - Slope / Level ..... 307
  - Smith (softkey) ..... 152
  - Smith chart ..... 42
  - Smoothing ..... 187
  - Softtool panel ..... 22
  - Software Option Info ..... 343
  - Sounds ..... 336
  - Source (calibration) ..... 263
  - Source Port ..... 138, 142
  - Source power calibration ..... 98
  - SPAN ..... 17
  - Span = Marker ..... 226
  - SPD ..... 807
  - SPE ..... 807
  - Split All ..... 322
  - Split Type ..... 325
  - SRE ..... 379, 383
  - SRQ ..... 379, 389, 806
  - Stability (menu) ..... 148
  - Stability (softkey) ..... 148
  - Stability factors ..... 61
  - START ..... 17
  - Start = Marker ..... 226
  - Start Cal Sweep ..... 271, 273
  - Start Frequency ..... 229
  - Start Power ..... 229
  - Status bar ..... 25
  - Status Registers ..... 379
  - Status reporting system
    - common commands ..... 398, 400
    - Error queue ..... 391
    - Parallel poll ..... 390
    - Queries ..... 391
    - Reset Values ..... 392
    - Serial poll ..... 390
    - Service request ..... 389
  - STB ..... 379, 383
  - Stimulus
    - Power ..... 230
    - Stimulus ..... 228
    - Time Domain X-Axis ..... 231
  - Stimulus Info ..... 327
  - Stimulus settings ..... 228
  - STOP ..... 17
  - Stop = Marker ..... 226
  - Stop Frequency ..... 229
  - Stop Power ..... 229
  - Stop Time ..... 229
  - Storing ..... 816
  - String ..... 369
  - Support ..... 800
  - Sweep
    - Sweep Control ..... 249
    - Sweep Params ..... 236
    - Sweep Type ..... 239
  - Sweep Active Channel ..... 252
  - Sweep All Channels ..... 252
  - Sweep History ..... 790
  - Sweep settings ..... 236
  - Sweep Time ..... 238
  - Sweep type ..... 239
  - Sweeps (sweep control) ..... 250
  - SWR (softkey) ..... 155
  - Syntax elements (SCPI, overview) ..... 369
  - System Configuration (dialog) ..... 333
  - System settings ..... 332
- ## T
- Target Search ..... 221
  - Target Value ..... 220
  - Test Port Assignment ..... 284
  - Text parameter ..... 369
  - Time (sweep) ..... 242
  - Time / Distance ..... 232
  - Time Center ..... 232
  - Time Domain ..... 176
  - Time domain analysis ..... 175
  - Time domain analysis (R&S ZNC/ZND-K2) ..... 110
  - Time Domain Transform ..... 110
  - Time Gate ..... 180
  - Time Span ..... 232
  - Time Start ..... 232
  - Time Stop ..... 232
  - Title (diagram) ..... 26, 321
  - Title Bar ..... 21
  - Title Bar Task Bar ..... 356
  - Tolerance (flatness cal) ..... 287
  - Tool 3 ... Tool 8 ..... 356
  - Toolbar ..... 21
  - Total readings (flatness cal) ..... 287
  - Touchstone (\*.s<n>p) file ..... 69



|                                       |        |
|---------------------------------------|--------|
| Trace .....                           | 12, 26 |
| programming examples .....            | 770    |
| Trace Colors per Diagram .....        | 329    |
| Trace Config .....                    |        |
| All Mem All Data .....                | 173    |
| Mem Math .....                        | 167    |
| Smooth Shift Hold .....               | 187    |
| Time Domain .....                     | 175    |
| Time Gate .....                       | 179    |
| Trace Data .....                      | 189    |
| Trace Statistics .....                | 181    |
| Traces .....                          | 162    |
| Trace Config settings .....           | 162    |
| Trace files .....                     | 68     |
| Trace Info .....                      | 327    |
| Trace list .....                      | 27     |
| Trace Manager (dialog) .....          | 164    |
| Trace Math .....                      | 169    |
| Trace settings .....                  | 126    |
| Tracking .....                        |        |
| bandfilter .....                      | 225    |
| marker search, target search .....    | 216    |
| multiple peak search .....            | 219    |
| Transmission coefficients .....       | 291    |
| Transparent Info Fields .....         | 336    |
| Trigger .....                         | 304    |
| Sweep Control .....                   | 309    |
| Trigger .....                         | 304    |
| Trigger Manager (dialog) .....        | 307    |
| Triple Split .....                    | 324    |
| Troubleshooting .....                 | 798    |
| TTL 1 / 2 Pass .....                  | 198    |
| Two Port Configuration (dialog) ..... | 290    |
| Type (calibration) .....              | 256    |
| Typical (cal kit) .....               | 87     |

## U

|                                             |          |
|---------------------------------------------|----------|
| Unbalance-balance conversion .....          | 57       |
| Units Prefix .....                          | 337      |
| Universal command .....                     | 365, 807 |
| Universal Interface .....                   | 808      |
| Unwrapped Phase (softkey) .....             | 155      |
| UP .....                                    | 369      |
| Upper edge (bandfilter) .....               | 34       |
| Upper limit .....                           | 63       |
| Upper/lower case (remote control) .....     | 399      |
| USB-to-IEC/IEEE Adapter .....               | 351      |
| Use Trc Color for Limit Lines .....         | 329      |
| User Cal Active .....                       | 292      |
| User Config .....                           |          |
| Balanced ports .....                        | 133      |
| User Def Math (dialog) .....                | 170      |
| User Interface (System Configuration) ..... | 336      |
| User manual .....                           | 9        |
| USER PORT .....                             | 803      |
| UTF-8 .....                                 | 333      |

## V

|                                                |     |
|------------------------------------------------|-----|
| Velocity Factor .....                          | 313 |
| View / Modify Cal Kit Standards (dialog) ..... | 279 |
| Virtual differential mode .....                | 57  |
| VISA .....                                     | 359 |
| VNA Port Assignment .....                      | 284 |
| VXI-11 .....                                   | 359 |

## W

|                        |     |
|------------------------|-----|
| Wave (menu) .....      | 139 |
| Wave Quantity .....    | 141 |
| Wave quantity .....    | 54  |
| Windows Explorer ..... | 357 |

## Y

|                               |     |
|-------------------------------|-----|
| Y <- (softkey) .....          | 145 |
| Y-parameter .....             | 53  |
| Y-Z-Params (menu) .....       | 146 |
| Y/Z-Parameter (softkey) ..... | 146 |
| Y←Sij (menu) .....            | 144 |
| Y<-S11 (softkey) .....        | 145 |
| Y<-S12 (softkey) .....        | 145 |
| Y<-S21 (softkey) .....        | 145 |
| Y<-S22 (softkey) .....        | 145 |
| Y11 (softkey) .....           | 147 |
| Y12 (softkey) .....           | 147 |
| Y21 (softkey) .....           | 147 |
| Y22 (softkey) .....           | 147 |

## Z

|                            |     |
|----------------------------|-----|
| Z ← (softkey) .....        | 143 |
| Z ← Sij (menu) .....       | 142 |
| Z-parameter .....          | 51  |
| Z←S11 (softkey) .....      | 143 |
| Z←S12 (softkey) .....      | 143 |
| Z←S21 (softkey) .....      | 143 |
| Z←S22 (softkey) .....      | 143 |
| Z11 (softkey) .....        | 147 |
| Z12 (softkey) .....        | 147 |
| Z21 (softkey) .....        | 147 |
| Z22 (softkey) .....        | 147 |
| Zero Delay at Marker ..... | 227 |
| Zoom .....                 |     |
| softtool panel .....       | 161 |
| Zoom Select .....          | 161 |
| Zoom Stimulus .....        | 230 |
| Zoom window .....          | 161 |